



Artisan Technology Group is your source for quality new and certified-used/pre-owned equipment

- FAST SHIPPING AND DELIVERY
- TENS OF THOUSANDS OF IN-STOCK ITEMS
- EQUIPMENT DEMOS
- HUNDREDS OF MANUFACTURERS SUPPORTED
- LEASING/MONTHLY RENTALS
- ITAR CERTIFIED SECURE ASSET SOLUTIONS

SERVICE CENTER REPAIRS

Experienced engineers and technicians on staff at our full-service, in-house repair center

*InstraView*SM REMOTE INSPECTION

Remotely inspect equipment before purchasing with our interactive website at www.instraview.com ↗

WE BUY USED EQUIPMENT

Sell your excess, underutilized, and idle used equipment. We also offer credit for buy-backs and trade-ins. www.artisanng.com/WeBuyEquipment ↗

LOOKING FOR MORE INFORMATION?

Visit us on the web at www.artisanng.com ↗ for more information on price quotations, drivers, technical specifications, manuals, and documentation

Contact us: (888) 88-SOURCE | sales@artisanng.com | www.artisanng.com



TroubleShooter, TroubleShooter RS, and Ranger High-Speed Cameras

Operator's Manual



Copyrights and Disclaimer

© 2005, Fastec Imaging Corporation. All Rights Reserved

This documentation is copyrighted material. Making unauthorized copies is prohibited by law. No part of this documentation may be reproduced, transmitted, transcribed, stored in a retrieval system or translated into any human or computer language without the prior written permission of Fastec Imaging Corporation. Fastec Imaging customers are allowed to use and copy the MotionMeasure Suite software without restriction.

Information in this document is provided in connection with Fastec Imaging products. Fastec Imaging believes the printed matter contained herein to be accurate from date of publication and reserves the right to make changes as necessary without notice. Fastec Imaging makes no commitment to update the information and shall have no responsibility whatsoever for conflicts or incompatibilities arising from future changes to the software or documentation.

No license, express or implied, or otherwise, to any intellectual property rights is granted by this document. Except as provided in Fastec Imaging's Terms and Conditions of Sale for such products, Fastec Imaging assumes no liability whatsoever.

THIS MANUAL IS PROVIDED "AS IS" WITHOUT WARRANTY OF ANY KIND, EITHER EXPRESSED OR IMPLIED, RELATING TO SALE AND/OR USE OF FASTEC IMAGING PRODUCTS INCLUDING LIABILITY OR WARRANTIES RELATING TO FITNESS FOR A PARTICULAR PURPOSE, CONSEQUENTIAL OR INCIDENTAL DAMAGES, MERCHANTABILITY, OR INFRINGEMENT OF ANY PATENT COPYRIGHT OR OTHER INTELLECTUAL PROPERTY RIGHT. FASTEC IMAGING FURTHER DOES NOT WARRANT THE ACCURACY OR COMPLETENESS OF THE INFORMATION, TEXT, GRAPHICS OR OTHER ITEMS CONTAINED WITHIN THIS MANUAL. FASTEC IMAGING SHALL NOT BE LIABLE FOR ANY SPECIAL, INDIRECT, INCIDENTAL, OR CONSEQUENTIAL DAMAGES, INCLUDING WITHOUT LIMITATION, LOST REVENUES OR LOST PROFITS, WHICH MAY RESULT FROM THE USE OF THIS DOCUMENT.

Fastec Imaging products are not intended for use in medical, lifesaving or life sustaining applications. Fastec Imaging customers using or selling Fastec Imaging products for use in such applications do so at their own risk and agree to fully indemnify Fastec Imaging for any damages resulting from such improper use or sale.

Trademarks

TroubleShooter™ is a trademark of Fastec Imaging Corporation.

Windows™ is a registered trademark of Microsoft Corporation.
Other brand or product names are trademarks of their respective holders.

Product names or services listed in this publication are for identification purposes only, and may be trademarks of third parties. Third-party brands and names are the property of their respective owners.

Reader Response

Fastec Imaging strives to produce quality documentation and welcomes your feedback. Please send comments and suggestions to Fastec Imaging. For technical questions, contact your local Fastec Imaging sales office.

Table of Contents

1. OVERVIEW OF TROUBLESHOOTER AND RANGER CAMERAS.....	1-1
1.1. Introduction to the Fastec Imaging Family of High-Speed Cameras	1-1
1.2. TroubleShooter and TroubleShooter HR Cameras	1-2
1.2.1. Camera Displays, Controls, Indicators and Connectors.....	1-3
1.3. TroubleShooter RS and TroubleShooter RSHR Cameras	1-5
1.3.1. Camera Displays, Controls, Indicators and Connectors.....	1-6
1.4. Ranger and Ranger HR Cameras	1-8
1.4.1. Camera Displays, Controls, Indicators and Connectors.....	1-9
1.5. MotionMeasure Software Suite	1-11
2. CAMERA SETUP	2-1
2.1. Unpack the camera	2-1
2.2. Getting Started	2-1
2.2.1. Install the Lens.....	2-1
2.2.2. Install the Camera Batteries or External Power Supply.....	2-2
2.2.3. Install or Remove the Compact Flash Card	2-3
2.2.4. CamLink with a Compact Flash Card Installed in the Camera	2-3
2.2.5. Camera Lens Back-Focus Adjustment.....	2-4
2.3. Connecting the Camera to a Computer.....	2-5
2.3.1. To Remotely Configure and Control a Camera from a PC	2-5
3. CAMERA CONFIGURATION	3-1
3.1. Technical Keypoints	3-1
3.1.1. Shutter Multiplier Setting.....	3-1
3.1.2. Record Time Matrix	3-2
3.1.3. Camera Internal Trigger	3-3
3.1.4. Remote Trigger Input	3-3
3.1.5. Sync Output Signal.....	3-4
3.1.6. Sync In Signal	3-4
3.1.7. Phase Lock Multiple Cameras	3-5
3.2. Floating Menu Configuration Commands and Displays	3-6
3.2.1. Record Mode Floating Menu	3-6
3.2.2. Playback and Stopped Mode Floating Menu	3-7
3.3. Configuration Screen Menus	3-8
3.3.1. Setup Menu Commands	3-9
3.3.2. Info Menu Commands.....	3-10
3.3.3. Set Date/Time Menu Commands.....	3-11
3.3.4. Default Setting Menu Commands.....	3-12
3.3.5. File Review Menu Commands	3-13
4. CAMERA OPERATIONAL PROCEDURES	4-1
4.1. Handheld Camera Operational Procedures	4-2
4.1.1. How to Setup the Camera for Handheld Operation	4-2
4.1.2. How to Record an Event	4-3
4.1.3. How to Playback an Event Stored in Camera Memory	4-4
4.1.4. How to Save an Event Stored in Camera Memory as an AVI File on the Compact Flash Card.....	4-4
4.1.5. How to Playback an Event AVI File Stored on the Compact Flash Card.....	4-6
4.2. Remote Camera Operational Procedures.....	4-7
4.2.1. How to Setup to Remotely Operate the Camera	4-9
4.2.2. How to Use CamLink to Remotely Record an Event.....	4-10
4.2.3. How to Use CamLink to Remotely Playback an Event Stored in Camera Memory	4-11
4.2.4. How to Use CamLink to Save an Event Stored in Camera Memory as an AVI File on the PC Hard Drive.....	4-12
5. INDEX.....	5-1

List of Figures

Figure 1-1: TroubleShooter and TroubleShooter HR Cameras	1-2
Figure 1-2: TroubleShooter and TroubleShooter HR Connector Panel and Back Panel	1-3
Figure 1-3: TroubleShooter RS and TroubleShooter RSHR Camera	1-5
Figure 1-4: TroubleShooter RS and TroubleShooter RSHR Connector Panel and Back Panel	1-6
Figure 1-5: Ranger and Ranger HR Camera	1-8
Figure 1-6: Ranger and Ranger HR Connector Panel and Back Panel	1-9
Figure 1-7: CamLink and MotionMeasure Splash Screens	1-11
Figure 1-8: CamLink and MotionMeasure Help Menus, About Submenus.....	1-11
Figure 3-1: Remote Trigger In Drive Circuitry	3-4
Figure 3-2: Sync Output Drive Circuitry.....	3-4
Figure 3-3: Multiple Cameras, Phase Locked Configuration.....	3-5
Figure 3-4: Record Mode Floating Menu.....	3-6
Figure 3-5: Playback and Stopped Mode Floating Menu.....	3-7
Figure 3-6: Configuration Screen, Setup Menu	3-9
Figure 3-7: Configuration Screen, Info Menu.....	3-10
Figure 3-8: Configuration Screen, Set Date / Time Menu	3-11
Figure 3-9: Configuration Screen, Default Menu	3-12
Figure 3-10: Configuration Screen, File Review Menu	3-13
Figure 4-1: Camera Operational Controls.....	4-1
Figure 4-2: Setting Save Limits.....	4-5
Figure 4-3: CamLink Window Buttons and Displays	4-7
Figure 4-4: Camera Displayed as a Removable Drive	4-9

List of Tables

Table 1-1: TroubleShooter and TroubleShooter HR Operational Specifications	1-2
Table 1-2: TroubleShooter and TroubleShooter HR Back Panel.....	1-3
Table 1-3: TroubleShooter and TroubleShooter HR Connector Panel	1-4
Table 1-4: TroubleShooter RS and TroubleShooter RS HR Operational Specifications.	1-5
Table 1-5: TroubleShooter RS and TroubleShooter RSHR Back Panel	1-6
Table 1-6: TroubleShooter RS and TroubleShooter RSHR Connector Panel.....	1-7
Table 1-7: Ranger and Ranger HR Operational Specifications.....	1-8
Table 1-8: Ranger and Ranger HR Back Panel	1-9
Table 1-9: Ranger and Ranger HR Connectors.....	1-10
Table 3-1: Shutter Speed Settings.....	3-1
Table 3-2: TroubleShooter Record Time Matrix	3-2
Table 3-3: TroubleShooter HR Record Time Matrix	3-2
Table 3-4: Trigger Points and Functions.....	3-3
Table 3-5: Record Mode Floating Menu Commands and Displays	3-6
Table 3-6: Playback and Stopped Mode Floating Menu Commands and Displays	3-7
Table 3-7: Configuration Screen Menu Operational Controls	3-8
Table 3-8: Setup Menu Configuration Settings and Description	3-9
Table 3-9: Info Menu Configuration Settings, Displays, and Description	3-10
Table 3-10: Set Date / Time Menu Configuration Settings and Description.....	3-11
Table 3-11: Default Menu Configuration Settings, Displays, and Description	3-12
Table 3-12: File Review Menu Soft Keys	3-13
Table 4-1: CamLink Window Buttons and Displays	4-7

Using this Guide

The purpose of this document is:

- ❑ To introduce users to the TroubleShooter and Ranger high-speed digital cameras.
- ❑ To guide the user through camera setup and configuration
- ❑ To describe camera operational procedures.

Additional Resources

Refer to the following documents for additional information about the Fastec Imaging systems and software.

Document Number	Title
QSG-MM0002	CamLink/MotionMeasure Quick Start Guide
QSG-TS0002	TroubleShooter Camera Quick Start Guide
OM-MM0001	MotionMeasure Suite Operator's Manual

1. Overview of TroubleShooter and Ranger Cameras

1.1. Introduction to the Fastec Imaging Family of High-Speed Cameras

Fastec Imaging sells a number of different models of TroubleShooter and Ranger high-speed digital cameras. The cameras offer either monochrome or color high-speed digital image recording capability, a wide range of recording rates, sensor resolutions, and on-board memory options. Monochrome cameras have an 8-bit pixel resolution. Color cameras have a 24-bit pixel resolution. All cameras come equipped with a standard C-mount lens mount, and 1/4-20 tripod mount. The Ranger also has a 3/8-16 mount.

This manual covers setup and operational procedures for the following cameras:

- ❑ TroubleShooter and TroubleShooter HR
- ❑ TroubleShooter RS and TroubleShooter RSHR
- ❑ Ranger and Ranger HR

The TroubleShooter and Ranger cameras support the following three modes of operation:

- ❑ Standalone camera operation, use on board SODIMM memory to save and playback captured images.
- ❑ Standalone camera operation, use a Compact Flash (CF) card to store images captured in the on board SODIMM memory.
- ❑ Remote operation of the camera, using the MotionMeasure software suite, a host PC, and USB 2.0 interface.

All cameras come with the following software:

- ❑ CamLink camera control software for recording, playback and downloading images to a computer. Images are downloaded and saved in AVI file format.
- ❑ MotionMeasure Software for image playback and analysis.

Because of built-in LCD screens, Compact Flashcard download and D-cell battery operation, TroubleShooter and Ranger cameras can be used to view and shoot an event with no setup or host computer necessary.

1.2. TroubleShooter and TroubleShooter HR Cameras

The TroubleShooter and TroubleShooter HR camera housing is made of injection molded PC ABS and machined, finished aluminum. The camera body and interface connectors are enclosed to resist dirt and moisture. This model is equipped with separate BNC connections for sync in, sync out, external trigger, IRIG-B, and a power plug. The camera is specially designed for either hand held standalone (no host computer) or remote controlled (host computer) operation. Power is supplied by an AC power adapter or D-cell batteries. IRIG-B can be input via BNC connector for use in military test range applications



Figure 1-1: TroubleShooter and TroubleShooter HR Cameras

The following table summarizes the operational specifications of the TroubleShooter and TroubleShooter HR cameras.

Table 1-1: TroubleShooter and TroubleShooter HR Operational Specifications

Component	Specification
Record Frames per Second	TroubleShooter: 125, 250, 500, 1000 TroubleShooter HR: 125, 250, 500, 1000, 2000, 4000, 8000, 16000
CMOS Sensor Resolution	TroubleShooter: 320x240, 640x480 TroubleShooter HR: 320x240, 640x480, 1280x32, 1280x64, 1280x128, 1280x256, 1280x512, 1280x1024 Note: 1280x512, 1280x256, 1280x128, 1280x64 and 1280x32 images are vertically stretched to assist viewing on the built-in camera display. The images are displayed in their original capture format aspect ratio when saved and displayed on a PC monitor.
On Board SODIMM Memory	TroubleShooter: 512 MB, 1 GB TroubleShooter HR: 1 GB, 2 GB, 3 GB
Manual and Remote Triggers	Start, 25%, 50%, 75%, End
IRIG Input	IRIG-B, Modulated
Frame Storage	TroubleShooter: 2,184 through 8,736 Frames TroubleShooter HR: 4,368 through 17,472 Frames
Record Time (sec)	TroubleShooter: 2.2 through 69.9 seconds TroubleShooter HR: 4.4 through 419.3 seconds

1.2.1. Camera Displays, Controls, Indicators and Connectors

Figure 1-2 shows the TroubleShooter and TroubleShooter HR displays, controls, indicators and connectors. Table 1-2 and Table 1-3 provide a brief description of each item.

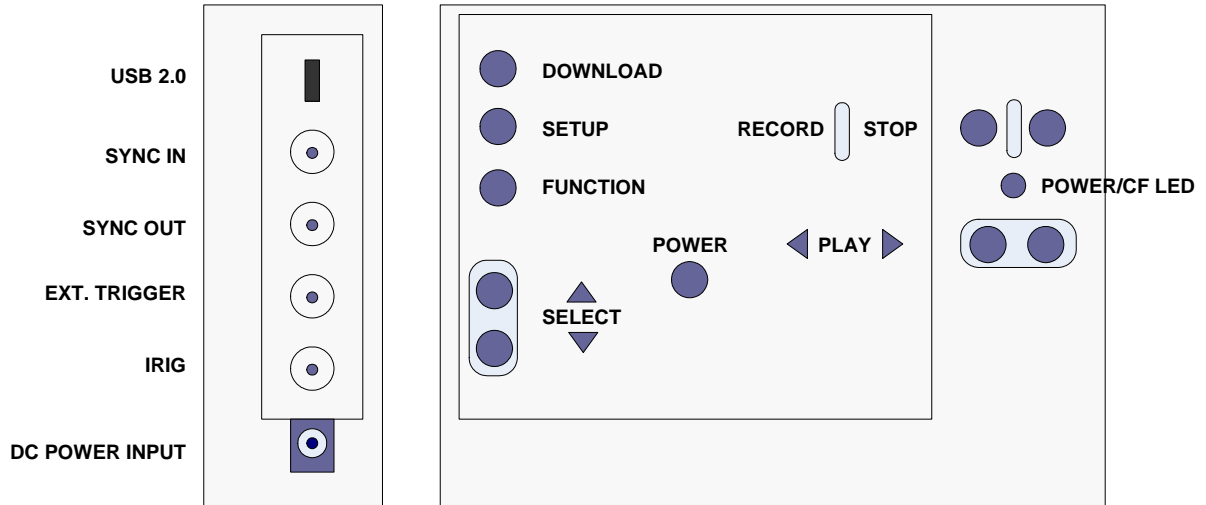

Figure 1-2: TroubleShooter and TroubleShooter HR Connector Panel and Back Panel

Table 1-2: TroubleShooter and TroubleShooter HR Back Panel

Back Panel	Description
Download Button	Initiate a download of images to the compact flash card.
Setup Button	Camera configuration commands and camera status are accessed through four Configuration Screen menus. Displays the camera Configuration menus. <ul style="list-style-type: none"> <input type="checkbox"/> Setup <input type="checkbox"/> Info <input type="checkbox"/> Set Date/Time <input type="checkbox"/> Default Settings
Function Button	Floating menus are used to access the most commonly used camera settings in real time. Select a superimposed floating menu item on the camera LCD display. The active menu item is illuminated green.
Select Up/Down Buttons	Select a specific parameter from the available parameters displayed by a floating menu item.
Power Button	Toggle to power up and shut down the camera. If the camera is on, there are images in the DRAM memory. If the Power button is pressed, the following message is displayed: <p><i>"Are you sure you want to turn off power???"</i> <i>All unsaved data will be lost.</i> <i>Press Stop to Cancel.</i> <i>Press Power again to Continue.</i></p>

Back Panel	Description
Record/Stop Buttons	<p>When the camera is powered up it defaults to Record mode. Pressing the Record button while in the Playback mode will cause the following warning screen to be displayed: <i>Are you sure you want to return to the Record mode???</i> <i>All unsaved data will be lost.</i> <i>Press Stop to Cancel.</i> <i>Press Power again to Continue.</i></p> <p>Press the Record button once to begin capturing images into camera on board memory.</p> <p>Press the Record button a second time to put the camera in Windowing Mode.</p> <ul style="list-style-type: none"> <input type="checkbox"/> Allows pan and zoom of selected image resolution. <p>Press the Record button a third time to put the camera in Focusing Mode.</p> <ul style="list-style-type: none"> <input type="checkbox"/> Allows you to zoom in to set focus <p>Press the Stop button to stop recording and exit the setup menus.</p> <p>Press the Stop button again to allow a zoom view of the stopped frame.</p> <ul style="list-style-type: none"> <input type="checkbox"/> Use Play and Select arrow buttons to pan the image
Power/CF LED	<p>Illuminate green when power is applied to the camera.</p> <p>Illuminate red while downloading data to the compact flash card.</p>
Play Fwd/Rev Buttons	Play back a captured event in a forward or reverse direction.

Table 1-3: TroubleShooter and TroubleShooter HR Connector Panel

Connector Panel	Description
USB 2.0 Connector	<p>Connect the camera to a PC running the MotionMeasure Software Suite.</p> <ul style="list-style-type: none"> <input type="checkbox"/> Mini B 5 pin connector on camera
Sync In Connector	Receive sync pulse signals from an external source. Can be a TroubleShooter camera in Master configuration or other instrument outputting a TTL level signal.
Sync Out Connector	Output sync pulse to drive a second TroubleShooter camera for Phase Lock operation. Also used for strobe control.
Ext. Trigger Connector	External trigger signal input used to initiate image capture.
IRIG Input Connector	<p>Input external IRIG standardized time code.</p> <ul style="list-style-type: none"> <input type="checkbox"/> Accepts IRIG-B modulated input for time stamping frames.
DC Power Input Connector	Apply 5 volt DC power to the camera.

1.3. TroubleShooter RS and TroubleShooter RSHR Cameras

The TroubleShooter RS and TroubleShooter RSHR ruggedized camera housing is made of 18 gauge cold-rolled steel. The camera body and interface connectors are enclosed to resist dirt and moisture. This model is equipped with separate BNC connections for sync and external trigger, and a power plug. The LCD monitor is built-in to the body of the camera. The camera is specially designed for hand held standalone (no host computer) or remote controlled (host computer) operation in harsh environments. Power is supplied by an AC power adapter or D-cell batteries. IRIG-B can be input via BNC connector for use in military test range applications



Figure 1-3: TroubleShooter RS and TroubleShooter RSHR Camera

The following table summarizes the operational specifications of the TroubleShooter RS and TroubleShooter RSHR cameras.

Table 1-4: TroubleShooter RS and TroubleShooter RS HR Operational Specifications

Component	Specification
Record Frames per Second	TroubleShooter RS: 125, 250, 500, 1000 TroubleShooter RSHR: 125, 250, 500, 1000, 2000, 4000, 8000, 16000
CMOS Sensor Resolution	TroubleShooter: 320x240, 640x480 TroubleShooter HR: 320x240, 640x480, 1280x32, 1280x64, 1280x128, 1280x256, 1280x512, 1280x1024 Note: 1280x512, 1280x256, 1280x128, 1280x64 and 1280x32 images are vertically stretched to assist viewing on the built-in camera display. The images are displayed in their original capture format aspect ratio when saved and displayed on a PC monitor.
On Board SODIMM Memory	TroubleShooter: 512 MB, 1 GB TroubleShooter HR: 1 GB, 2 GB, 3 GB
Manual and Remote Triggers	Start, 25%, 50%, 75%, End
IRIG Input	IRIG-B, Modulated
Frame Storage	TroubleShooter RS: 2,184 through 17,472 Frames TroubleShooter RSHR: 1,024 through 98,304 Frames
Record Time (sec)	TroubleShooter RS: 2.2 through 139.8 seconds TroubleShooter RSHR: 2.0 through 419.3 seconds

1.3.1. Camera Displays, Controls, Indicators and Connectors

Figure 1-4 shows the TroubleShooter RS and TroubleShooter RSHR displays, controls, indicators and connectors. Table 1-5 and Figure 1-6 provide a brief description of each item.

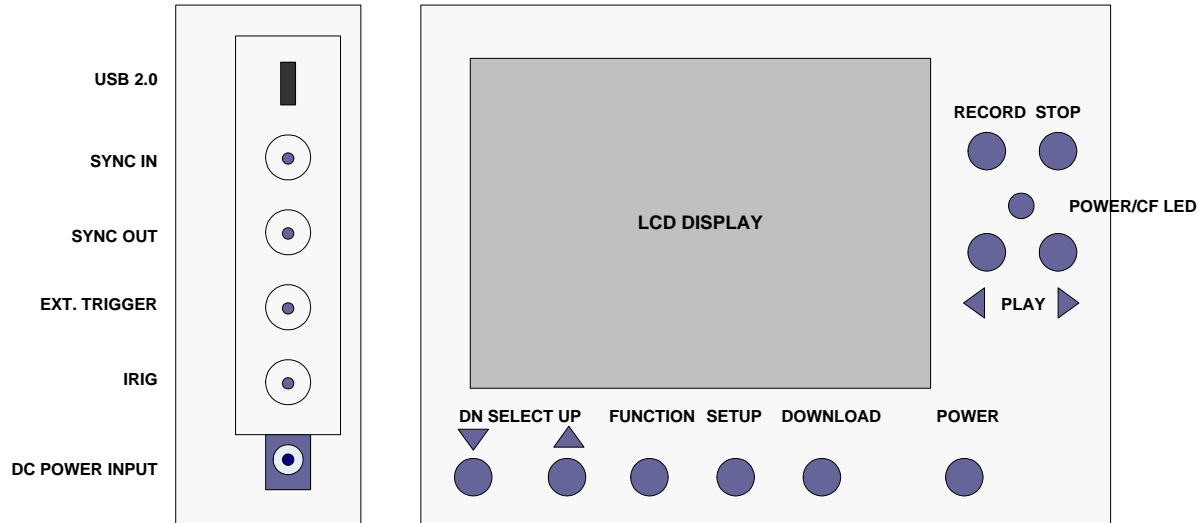

Figure 1-4: TroubleShooter RS and TroubleShooter RSHR Connector Panel and Back Panel

Table 1-5: TroubleShooter RS and TroubleShooter RSHR Back Panel

Back Panel	Description
Download Button	Initiate a download of images to the compact flash card.
Setup Button	Camera configuration commands and camera status are accessed through four Configuration Screen menus. Displays the camera Configuration menus. <ul style="list-style-type: none"> <input type="checkbox"/> Setup <input type="checkbox"/> Info <input type="checkbox"/> Set Date/Time <input type="checkbox"/> Default Settings
Function Button	Floating menus are used to access the most commonly used camera settings in real time. Select a superimposed floating menu item on the camera LCD display. The active menu item is illuminated green.
Select Up/Down Buttons	Select a specific parameter from the available parameters displayed by a floating menu item.
Power Button	Toggle to power up and shut down the camera. If the camera is on, there are images in the DRAM memory. If the Power button is pressed, the following message is displayed: <i>"Are you sure you want to turn off power???"</i> <i>All unsaved data will be lost.</i> <i>Press Stop to Cancel.</i> <i>Press Power again to Continue.</i>

Back Panel	Description
Record/Stop Buttons	<p>When the camera is powered up it defaults to Record mode. Pressing the Record button while in the Playback mode will cause the following warning screen to be displayed:</p> <p><i>Are you sure you want to return to the Record mode???</i> <i>All unsaved data will be lost.</i> <i>Press Stop to Cancel.</i> <i>Press Power again to Continue.</i></p> <p>Press the Record button once to begin capturing images into camera on board memory.</p> <p>Press the Record button a second time to put the camera in Windowing Mode.</p> <ul style="list-style-type: none"> <input type="checkbox"/> Allows pan and zoom of selected image resolution. <p>Press the Record button a third time to put the camera in Focusing Mode.</p> <ul style="list-style-type: none"> <input type="checkbox"/> Allows you to zoom in to set focus <p>Press the Stop button to stop recording and exit the setup menus.</p> <p>Press the Stop button again to allow a zoom view of the stopped frame.</p> <ul style="list-style-type: none"> <input type="checkbox"/> Use Play and Select arrow buttons to pan the image
Power/CF LED	<p>Illuminate green when power is applied to the camera.</p> <p>Illuminate red while downloading data to the compact flash card.</p>
Play Fwd/Rev Buttons	Play back a captured event in a forward or reverse direction.

Table 1-6: TroubleShooter RS and TroubleShooter RSHR Connector Panel

Connector Panel	Description
USB 2.0 Connector	<p>Connect the camera to a PC running the MotionMeasure Software Suite.</p> <ul style="list-style-type: none"> <input type="checkbox"/> Mini B 5 pin connector on camera
Sync In Connector	Receive sync pulse signals from an external source. Can be a TroubleShooter camera in Master configuration or other instrument outputting a TTL level signal.
Sync Out Connector	Output sync pulse to drive a second TroubleShooter camera for Phase Lock operation. Also used for strobe control.
Ext. Trigger Connector	External trigger signal input used to initiate image capture.
IRIG Input Connector	<p>Input external IRIG standardized time code.</p> <ul style="list-style-type: none"> <input type="checkbox"/> Accepts IRIG-B modulated input for time stamping frames.
DC Power Input Connector	Apply 5 volt DC power to the camera.

1.4. Ranger and Ranger HR Cameras

The Ranger and Ranger HR ruggedized camera housing is made of 18 gauge cold-rolled steel. The housing, keypads, connectors, and Compact Flash card interface are sealed to resist dirt and moisture. This model is equipped with a single Bendix connector for power, sync, video out, and trigger signals. The LCD monitor is built-in to the body of the camera. The camera is specially designed for hand held standalone (no host computer) or remote controlled (host computer) operation in harsh environments. Power is supplied by an AC power adapter or D-cell batteries. IRIG-B can be input via BNC connector for use in military test range applications



Figure 1-5: Ranger and Ranger HR Camera

The following table summarizes the operational specifications of the Ranger and Ranger HR cameras.

Table 1-7: Ranger and Ranger HR Operational Specifications

Component	Specification
Record Frames per Second	Ranger: 125, 250, 500, 1000 Ranger HR: 125, 250, 500, 1000, 2000, 4000, 8000, 16000
CMOS Sensor Resolution	Ranger: 320x240, 640x480 Ranger HR: 320x240, 640x480, 1280x32, 1280x64, 1280x128, 1280x256, 1280x512, 1280x1024 Note: 1280x512, 1280x256, 1280x128, 1280x64 and 1280x32 images are vertically stretched to assist viewing on the built-in camera display. The images are displayed in their original capture format aspect ratio when saved and displayed on a PC monitor.
On Board SODIMM Memory	Ranger: 512 MB, 1 GB Ranger HR: 1 GB, 2 GB, 3 GB
Manual and Remote Triggers	Start, 25%, 50%, 75%, End
IRIG Input	IRIG-B, Modulated
Frame Storage	Ranger: 2,184 through 17,472 Frames Ranger HR: 1,024 through 98,304 Frames
Record Time (sec)	Ranger: 2.2 through 139.8 seconds Ranger HR: 2.0 through 419.3 seconds

1.4.1. Camera Displays, Controls, Indicators and Connectors

Figure 1-6 shows the Ranger and Ranger HR displays, controls, indicators and connectors. Table 1-8 and Table 1-9 provides a brief description of each item.

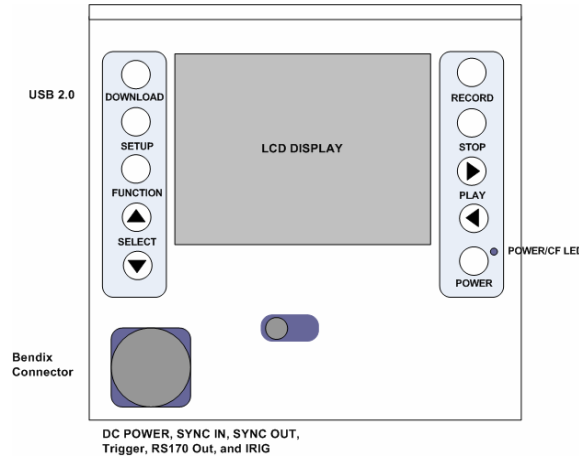

Figure 1-6: Ranger and Ranger HR Connector Panel and Back Panel

Table 1-8: Ranger and Ranger HR Back Panel

Back Panel	Description
Download Button	Initiate a download of images to the compact flash card.
Setup Button	Camera configuration commands and camera status are accessed through four Configuration Screen menus. Displays the camera Configuration menus. <ul style="list-style-type: none"> <input type="checkbox"/> Setup <input type="checkbox"/> Info <input type="checkbox"/> Set Date/Time <input type="checkbox"/> Default Settings
Function Button	Floating menus are used to access the most commonly used camera settings in real time. Select a superimposed floating menu item on the camera LCD display. The active menu item is illuminated green.
Select Up/Down Buttons	Select a specific parameter from the available parameters displayed by a floating menu item.
Power Button	Toggle to power up and shut down the camera. If the camera is on, there are images in the DRAM memory. If the Power button is pressed, the following message is displayed: <i>"Are you sure you want to turn off power???"</i> <i>All unsaved data will be lost.</i> <i>Press Stop to Cancel.</i> <i>Press Power again to Continue.</i>

Back Panel	Description
Record/Stop Buttons	<p>When the camera is powered up it defaults to Record mode. Pressing the Record button while in the Playback mode will cause the following warning screen to be displayed: <i>Are you sure you want to return to the Record mode???</i> <i>All unsaved data will be lost.</i> <i>Press Stop to Cancel.</i> <i>Press Power again to Continue.</i></p> <p>Press the Record button once to begin capturing images into camera on board memory.</p> <p>Press the Record button a second time to put the camera in Windowing Mode.</p> <ul style="list-style-type: none"> <input type="checkbox"/> Allows pan and zoom of selected image resolution. <p>Press the Record button a third time to put the camera in Focusing Mode.</p> <ul style="list-style-type: none"> <input type="checkbox"/> Allows you to zoom in to set focus <p>Press the Stop button to stop recording and exit the setup menus.</p> <p>Press the Stop button again to allow a zoom view of the stopped frame.</p> <ul style="list-style-type: none"> <input type="checkbox"/> Use Play and Select arrow buttons to pan the image
Power/CF LED	<p>Illuminate green when power is applied to the camera.</p> <p>Illuminate red while downloading data to the compact flash card.</p>
Play Fwd/Rev Buttons	<p>Play back a captured event in a forward or reverse direction.</p>

Table 1-9: Ranger and Ranger HR Connectors

Connector Panel	Description
USB 2.0 Connector	<p>Connect the camera to a PC running the MotionMeasure Software Suite.</p> <ul style="list-style-type: none"> <input type="checkbox"/> Mini B 5 pin connector on camera
DC Power, Sync In, Sync Out, Video Out, Trigger and IRIG in Bendix Connector	<p>The connector contains the following inputs and outputs:</p> <ul style="list-style-type: none"> <input type="checkbox"/> Apply 5 volt DC power to the camera. <input type="checkbox"/> Synchronize multiple cameras to record an event. <input type="checkbox"/> External trigger signal input used to initiate image capture. <input type="checkbox"/> Input external IRIG standardized time code. <input type="checkbox"/> Output RS170 video

1.5. MotionMeasure Software Suite

Your camera comes with a MotionMeasure CD ROM. To check for the latest version of the software, visit the following web site:

- ❑ <http://www.tetracam.com/fastec/MMSetup.zip>

The update is provided in a .ZIP file format and consists of an install program containing the updated executables and help files.

Check the version numbers on the web page against the version numbers on your programs. The program versions numbers can be found in the following locations:

- ❑ The splash screens when the programs are first opened
- ❑ The MotionMeasure **Help** menu, **About** submenu



Figure 1-7: CamLink and MotionMeasure Splash Screens



Figure 1-8: CamLink and MotionMeasure Help Menus, About Submenus



2. Camera Setup

2.1. Unpack the camera

When you unpack your shipping box in addition to this manual you should find the following items:

- ❑ High-Speed Digital Camera
- ❑ Application Software, Operator's Guides and Quick Start Guides on a CD ROM
- ❑ MotionMeasure/CamLink and Camera Quick Start Guides
- ❑ AC/DC 5 Volt Power Supply
- ❑ Additional items may be supplied by local distributors

A user supplied Lens, Power Adapter Cable (AC operation), and USB Download Cable, and CF card are required for operation.

Fastec Imaging sells its cameras through independent distributors. The distributors will provide the accessory items required for camera operation according to each customer's particular application needs.

2.2. Getting Started

Prior to operating the camera the following items must be installed:

- ❑ Lens
- ❑ Power source (on board batteries or external AC/DC power)
- ❑ An optional compact flash card can be inserted into the camera

2.2.1. Install the Lens

To install the lens:

- Step 1** Remove the lens receptacle cover from the camera's C-mount.
- ❑ The cover is installed at the factory to protect the image sensor.
- Step 2** Thread a C-mount lens into the lens mount in the front of the camera.
- ❑ Do not overtighten the lens. The lens should be "finger tight".
 - ❑ As a starting point for recording, open the lens aperture about half way and set the lens focus to infinity.

Note: Avoid holding the camera with the lens opening facing up after the dust cover is removed. Dust could settle on the face of the sensor and degrade the image quality.

2.2.2. Install the Camera Batteries or External Power Supply

The camera is powered from Four D-Cell Nickel Metal Hydride (NiMH) batteries (optional), or an external 5V power supply (included). Depending on the model, the batteries are installed in either the bottom or side of the camera.

Standard D cell batteries do not provide enough power to operate the camera for more than a few minutes. High powered D cell batteries, 8500 m/Ah or greater are recommended. D cell batteries rate at 8500 m/Ah will provide approximately 2 hours of continuous use.

To install batteries:

- Step 1** With the LCD display in the docked (closed) position, open the battery compartment door.
- Step 2** Install the batteries as indicated by the polarity labels inside the battery compartment.
- Step 3** Replace the battery compartment door and upright the camera.
- Step 4** Unfold the LCD display and press the Power button. If the batteries were inserted correctly, the Power LED illuminates green
- Step 5** If the Power LED doesn't illuminate:
 - Recheck battery polarity
 - Check the battery charge level

When the camera is going to be used for extended periods of time, battery life can be preserved by using the external 5 volt power supply adapter that came with the camera. The TroubleShooter camera external power supply connector is located on the side of the camera. The Ranger external power is supplied through the Bendix connector on the back of the camera

To connect the external power supply:

- Step 1** Make sure the camera is turned off.
- Step 2** Connect the external power cable to the external power jack on the camera.
 - External power is supplied to the Ranger camera through the Bendix cable supplied with the camera.
- Step 3** Unfold the LCD display and press the Power button.
- Step 4** If the Power LED doesn't illuminate:
 - Recheck cable connections
 - Be sure that the AC/DC 5 volt power adapter is receiving AC power.

2.2.3. Install or Remove the Compact Flash Card

The camera can capture and play back high-speed image clips without a compact flash card being installed. Image files can be permanently saved using a CF card. For best results in download speeds, Fastec Imaging recommends use of a Scan Disk Extreme III CF card. Other brands of CF cards will download more slowly or may not work at all.

To insert the Compact Flash (CF) card:

- Step 1** Open up the CF card door on the side of the camera.
- Step 2** Insert a new CF card with the label facing towards the back of the unit.
 - Press the card along the guide slots until it seats against the connector pins

To release the Compact Flash card:

- Step 1** Press the ejector mechanism above the CF card.
- Step 2** After the CF card is released, remove the CF card from the slot.

The images recorded on the CF card are stored in an uncompressed AVI file format. The stored files can be viewed on the camera's built-in monitor using the File Review menu or using MotionMeasure Suite, or a conventional media player, such as the Windows Media Player.

2.2.4. CamLink with a Compact Flash Card Installed in the Camera

Remove the compact flash card before starting the CamLink software. Otherwise, the camera will appear as a mass storage device and CamLink will not recognize it.

If you forget to remove the compact flash before starting CamLink:

- Step 1** Close the CamLink program and remove the CF card from the camera.
- Step 2** Disconnect and re-connect the USB cable to initialize the camera as an imaging device recognizable to CamLink.
- Step 3** Restart the CamLink application.

2.2.5. Camera Lens Back-Focus Adjustment

The C-mount on TroubleShooter and Ranger cameras is adjustable to allow you to perform a lens back-focus adjustment. When you perform a back-focus adjustment you change the distance between the flange mount surface of the lens and the CMOS sensor array. A properly focused lens will maintain focus at both ends of its zoom range.

In most cases, changing the lens on your camera will not require a lens back-focus adjustment.

To perform a Lens Back-Focus adjustment:

- Step 1** Place the camera on a tripod.
- Step 2** Turn on the camera and focus on an object at least 20 feet away (or as far away as possible).
- Step 3** Set the lens iris to wide open.
- Step 4** Focus in on the target object.
- Step 5** Adjust the focus normally until the picture is sharp.
- Step 6** Focus out from the target.
- Step 7** Loosen the back-focus ring retaining screws (two screws behind the lens).
- Step 8** Rotate the C mount until the picture is sharp (rotate no further than 45 degrees in either direction):
 - Counter-clockwise rotation increases lens focal length.
 - Clockwise rotation decreases lens focal length.
- Step 9** Tighten the back focus ring retaining screws.
- Step 10** Check for sharp focus at both ends of the focus range.
- Step 11** Repeat steps 4 through 10 until the focus is sharp at both ends of the focus range.

2.3. Connecting the Camera to a Computer

All TroubleShooter and Ranger cameras can be connected to a computer over a USB 2.0 cable. The camera USB connector is located behind the access door on the left side of the camera, viewed from the rear. Once the camera is connected to the computer, the CamLink software can be used to remotely configure and control camera operation. Events recorded in the camera memory can also be saved as AVI files on the computer.

2.3.1. To Remotely Configure and Control a Camera from a PC

- Step 1** Install the MotionMeasure/CamLink software on your computer.
 - ☐ Refer to MotionMeasure Suite Operation's Manual (OM-MM0001).
- Step 2** Supply power to the camera.
- Step 3** If a compact flash card is installed in the camera, remove the card. Refer to Chapter 2.2.4, CamLink with a Compact Flash Card Installed in the Camera.
- Step 4** Raise the LCD display and press the camera **POWER** button.
- Step 5** Using a USB cable, connect the camera to your computer USB port. The device window shown below opens on the computer desktop indicating a connection with the camera. The USB cable needs to have a Mini B 5-Pin connector at the camera connection point.
 - ☐ To your computer, the camera appears as a mass storage device.

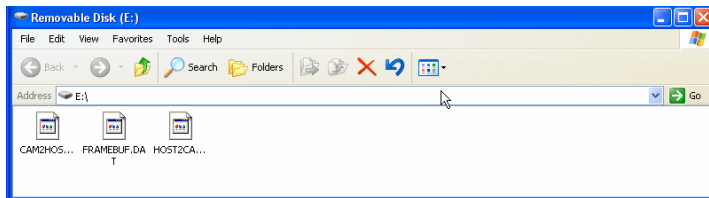

- Step 6** Replace the CF card if you need to save images for later review.
- Step 7** Double-click on the CamLink desktop icon to open the CamLink application.
- Step 8** Click on the **Scan for Cameras** button in the CamLink window.



- Step 9** Select a desired camera drive letter to begin using the camera.





3. Camera Configuration

3.1. Technical Keypoints

3.1.1. Shutter Multiplier Setting

The shutter multiplier setting determines the camera shutter speed. Shutter speed is defined as the inverse values of the frame rate times the shutter multiplier.

For example:

- ❑ **Frame Rate** = 250 fps (inverse value is 1/250 or .004 seconds)
- ❑ **Shutter Multiplier** = A setting of 4X (inverse value is 1/4th or .25)
- ❑ **Shutter speed** = .004 x .25 or .001 seconds

The following table displays shutter speeds based on selected Frame Rates and Shutter Multipliers.

Table 3-1: Shutter Speed Settings

Shutter Multiplier (Reciprocal)	Record Rate in Frames per Second (Reciprocal)					
	50 (.020)	60 (.0167)	125 (.008)	250 (.004)	500 (.002)	1000 (.001)
1X	.020000	.016700	.008000	.004000	.002000	.001000
2X (.500)	.010000	.008333	.004000	.002000	.001000	.000500
3X (.333)	.006666	.005560	.002670	.001330	.000667	.000333
4X (.250)	.005000	.004170	.002000	.001000	.000500	.000250
5X (.200)	.004000	.003330	.001600	.000800	.000400	.000200
10X (.100)	.002000	.001667	.000800	.000400	.000200	.000100
20X (.050)	.001000	.000833	.000400	.000200	.000100	.000050

Changing shutter does not change record rate or frame resolution. Faster shutter speeds reduce object blur.

3.1.2. Record Time Matrix

The event record time and maximum number of frames stored is determined by the following factors:

- ❑ Recorded frames per second
- ❑ Sensor resolution selection
- ❑ Onboard camera memory

Table 3-2: TroubleShooter Record Time Matrix

Frames per Second	Sensor Resolution	Standard Memory 512 MB		Enhanced Memory 1 GB	
		Total Frames	Record Time (Sec)	Total Frames	Record Time (Sec)
125	640 x 480	2,184	17.5	4,368	34.9
250	640 x 480	2,184	8.7	4,368	17.5
500	640 x 480	2,184	4.4	4,368	8.7
1000	640 x 480	2,184	2.2	4,368	4.4
125	320 x 240	8,736	69.9	17,472	139.8
250	320 x 240	8,736	34.9	17,472	69.9
500	320 x 240	8,736	17.5	17,472	34.9
1000	320 x 240	8,736	8.7	17,472	17.5

Table 3-3: TroubleShooter HR Record Time Matrix

Frames per Second	Sensor Resolution	Standard Memory 1 GB		Standard Memory 2 GB		Standard Memory 3 GB	
		Total Frames	Record Time (Sec)	Total Frames	Record Time (Sec)	Total Frames	Record Time (Sec)
125	1280 x 1024	1,024	8.2	2,048	16.4	3,072	24.5
250	1280 x 1024	1,024	4.1	2,048	8.2	3,072	12.3
500	1280 x 1024	1,024	2.0	2,048	4.1	3,072	6.1
1000	1280 x 512	2,048	2.0	4,096	4.1	6,144	6.1
2000	1280 x 256	4,096	2.0	8,192	4.1	12,288	6.1
4000	1280 x 128	8,192	2.0	16,384	4.1	24,576	6.1
8000	1280 x 64	16,384	2.0	32,768	4.1	49,152	6.1
16000	1280 x 32	32,768	2.0	65,572	4.1	98,304	6.1
125	640 x 480	4,368	34.9	8,736	69.9	13,104	104.8
250	640 x 480	4,368	17.5	8,736	34.9	13,104	52.4
500	640 x 480	4,368	8.7	8,736	17.5	13,104	26.2
1000	640 x 480	4,368	4.4	8,736	8.7	13,104	13.1
125	320 x 240	17,476	139.8	34,952	279.6	52,428	419.3
250	320 x 240	17,476	69.9	34,952	139.8	52,428	209.7
500	320 x 240	17,476	34.9	34,952	69.9	52,428	104.8
1000	320 x 240	17,476	17.5	34,952	34.9	52,428	52.4
2000	320 x 240	17,476	8.7	34,952	17.5	52,428	26.2

3.1.3. Camera Internal Trigger

Image capture is referenced to the frame that's captured the moment you click on the camera **Stop** button or a remote trigger input is detected by the camera. This frame is called the trigger point and is always tagged as frame 0000.

The trigger point is expressed as a percentage of the total frames captured, or as the Start (beginning) or End of the video frame capture. Images captures before a trigger frame are designated with negative numbers and images captured after a trigger frame are designated with positive numbers.

Table 3-4: Trigger Points and Functions

Trigger	Function
Start	Begin capturing image frames in camera memory when the trigger point is detected. <input type="checkbox"/> Make the trigger point the first frame captured.
25%	Retain 25% of the frames captured before the trigger point was detected. <input type="checkbox"/> Record new frames in the remaining 75% of camera memory.
50%	Retain 50% of the frames captured before the trigger point was detected. <input type="checkbox"/> Record new frames in the remaining 50% of camera memory.
75%	Retain 75% of the frames captured before the trigger point was detected. <input type="checkbox"/> Record new frames in the remaining 25% of camera memory.
End	Stop capturing frames in camera memory once the trigger point is detected. <input type="checkbox"/> Retain all frames recorded in camera memory up to the moment of the trigger.

3.1.4. Remote Trigger Input

A remote trigger signal can be used to initiate image capture. When connecting multiple cameras together, make sure the external trigger is connected to the first camera (Master) in the chain.

The REMOTE TRIGGER IN signal is input through the second BNC connector from the bottom on the side of the TroubleShooter camera. The REMOTE TRIGGER IN signal is input through the Bendix connector on the Ranger camera.

The REMOTE TRIGGER IN signal is a low true (less than .7 volts DC) input to a type SN74LVC14A inverter. It can be grounded through a simple momentary switch or be driven actively. The input can tolerate +/- 30V. An input voltage below 0.7V is "true" and above 2.0V is "false". There is a 100K Ohm pull-up resistor at the inverter input that clamps to 3.3V and ground downstream of a 990 Ohm current limiter.

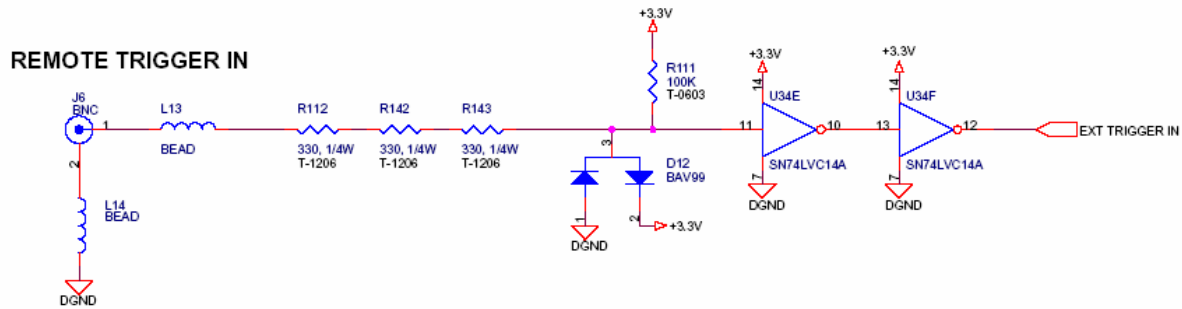

Figure 3-1: Remote Trigger In Drive Circuitry

3.1.5. Sync Output Signal

Every image frame capture generates a SYNC OUT signal that can be used in multiple locations to synchronize external equipment with the event. The SYNC OUT signal is output through the second BNC connector from the top on the side of the TroubleShooter camera. The SYNC OUT signal is output through the Bendix connector on the Ranger camera.

The SYNC OUT signal is a positive-going, 3.3 volt, 20 microsecond nominally square pulse whose rising edge corresponds to the beginning of the integration time for the current frame. It is driven by a type 74LVC14A buffer through 990 Ohm.

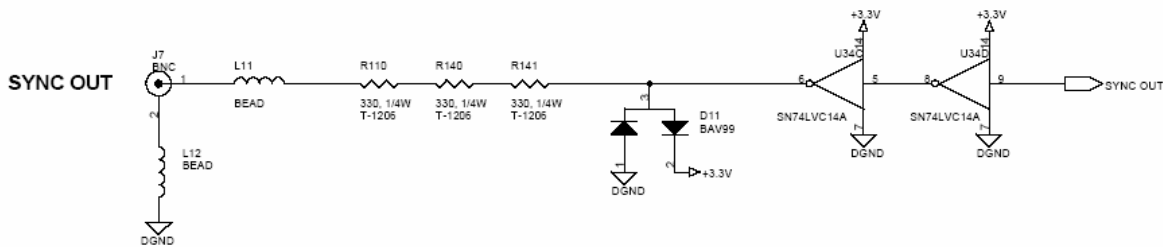

Figure 3-2: Sync Output Drive Circuitry

3.1.6. Sync In Signal

Used to provide an input signal to a synchronize Slave cameras with the MASTER camera.

3.1.7. Phase Lock Multiple Cameras

Fastec Imaging cameras have the ability to perform synchronized recording in a parallel configuration. If only cameras are implemented, the first camera in the chain is designated as the "Master" and all additional cameras in the chain are synchronized to the Master in a "Slave" mode.

If external trigger hardware is present, all cameras in the parallel chain are operated in the "Slave" mode to the external event trigger.

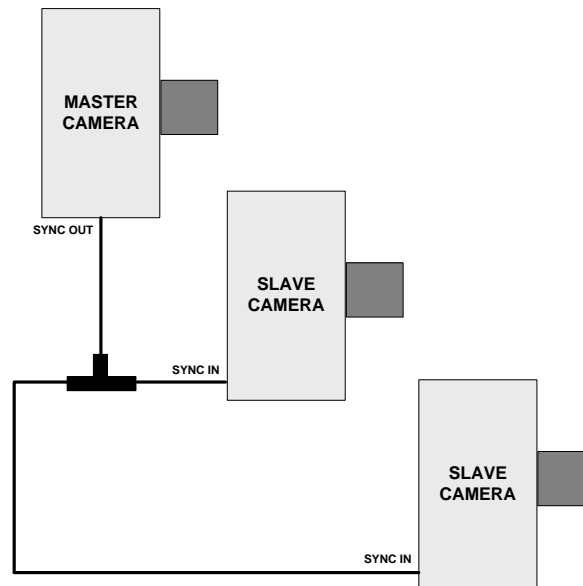

Figure 3-3: Multiple Cameras, Phase Locked Configuration

To operate parallel chained cameras in a synchronized mode:

- Step 1** On the first camera in the chain, Set the **SETUP** menu **SYNC MODE** command to "MASTER". Refer to Section 3.3.1.
- Step 2** On subsequent cameras in the chain, Set the **SETUP** menu **SYNC MODE** command to "Slave".
- Step 3** Ensure all cameras are set at the same **RECORD RATE**. Refer to Section 3.2.1.
- Step 4** Press the Master camera **RECORD** button to begin synchronized recording of images on all cameras in the chain.
- Step 5** Press the Master camera **STOP** button to stop recording.
 - All Slave cameras will freeze in the RECORD mode.
- Step 6** Repeat Steps 4 and 5 as required.

3.2. Floating Menu Configuration Commands and Displays

There are two menu schemes implemented to configure the camera.

- ❑ Frequently accessed Record and Playback commands and displays are superimposed over the image display using a Floating menu.
- ❑ Less frequently accessed camera configuration commands are accessed through four Configuration Screen menus.

3.2.1. Record Mode Floating Menu

Figure 3-4 shows the Record Mode floating menu configuration commands and displays. Table 3-5 provides a brief description of command and displays.

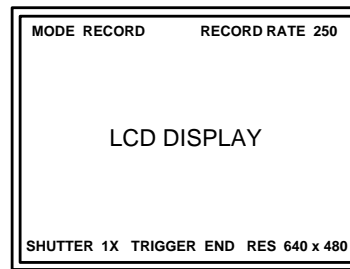

Figure 3-4: Record Mode Floating Menu

Table 3-5: Record Mode Floating Menu Commands and Displays

Command/Display	Description
MODE RECORD	Mode of Operation displays: Current camera operational mode displayed (Record)
MODE WINDOWING	Mode accessed by pressing the RECORD button a second time when in Mode Record
MODE FOCUSING	Mode accessed by pressing the RECORD button a second time when in Mode Windowing. This mode zooms into a 320x240 view of the total field of view for close up focus adjustment. Press the RECORD button again to return to Mode Record.
RECORD RATE 250	Record Rate command: Displays the current Record Rate setting in frames per second. ❑ Factory Default Setting: 250 frames per second
RES 640x480	Resolution command: Display the current Record Resolution setting in pixels. ❑ Factory Default Setting: 640x480
TRIGGER END	Capture Event Trigger command: Display the current Trigger setting. ❑ Factory Default Setting: End Trigger – Stop recording when the STOP button is pressed.
SHUTTER 1X	Shutter command: Display the current Shutter Speed setting. ❑ Factory Default Setting: 1X

3.2.2. Playback and Stopped Mode Floating Menu

Figure 3-5 shows the Playback and Stopped Mode floating menu configuration commands and displays. Table 3-6 provides a brief description of command and displays.

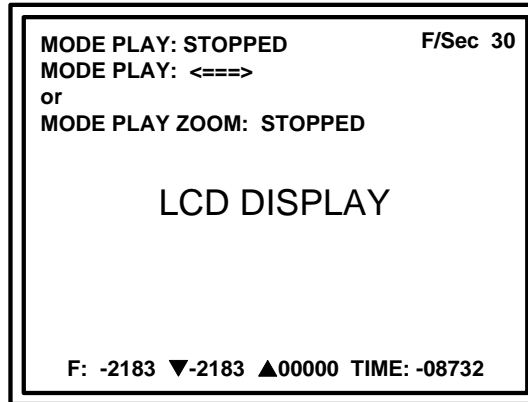

Figure 3-5: Playback and Stopped Mode Floating Menu

Table 3-6: Playback and Stopped Mode Floating Menu Commands and Displays

Command/Display	Description
MODE PLAY: STOPPED	Mode of Operation displays: Camera record stopped, one recorded image displayed
MODE PLAY: <====>	Playback either Forward <====> or Reverse <==== direction
MODE PLAY ZOOM: STOPPED	Mode accessed by pressing the STOP button a second time when in Mode Play: Stopped. This mode allows you to pan a 320x240 window over a single larger frame using the PLAY and SELECT buttons
F/Sec 30	Playback Rate command Displays the current playback Rate setting in frames per second. <input type="checkbox"/> Factory Default Setting: 30 frames per second
FRAME: -2183	Frame number currently being displayed <input type="checkbox"/> Standard onboard memory stores 2184 frames <input type="checkbox"/> Enhanced onboard memory (HR) stores 4,368 frames Play button reverse playback direction.
▼ -2183 (First Frame) ▲ 00000 (Last Frame)	Beginning (▼) and end (▲) points of the frame interval saved to compact flash card when the Download button is pressed. <input type="checkbox"/> Factory Default Setting: All frames
TIME: -08732	Elapsed Playback Time display Time displayed in milliseconds.

3.3. Configuration Screen Menus

All user configurable camera settings are managed by five screen menus All menus are accessed by toggling the **SETUP** button (except the File Review menu)).

- ❑ **SETUP** – Change record mode settings
- ❑ **INFO** – Display camera information
- ❑ **SET DATE/TIME** – Set saved AVI file header date and time values
- ❑ **DEFAULT SETTINGS** – Set camera power-up default settings
- ❑ **FILE REVIEW** – Display or delete stored events on the CF card from the camera

The above menu screens are access and navigated by pressing the camera button described in Table 3-7.

Table 3-7: Configuration Screen Menu Operational Controls

Camera Button	Function
SETUP	Blanks out the camera LCD screen and displays the first Configuration Screen menu (Setup). Toggle this button to access additional Configuration Screen menus.
FUNCTION	Toggle this button to scroll to a configuration command of interest. The active command is highlighted in green.
SELECT	Toggle this button to view available command parameters.
STOP	Press this button to exit the Configuration Screen menus and save settings.
FILE REVIEW	Menu soft keys used access files on the Compact flash card. Refer to Section 3.3.5.

3.3.1. Setup Menu Commands

Figure 3-6 shows the SETUP menu and current configuration settings. Table 3-8 provides a brief description of commands and displays.

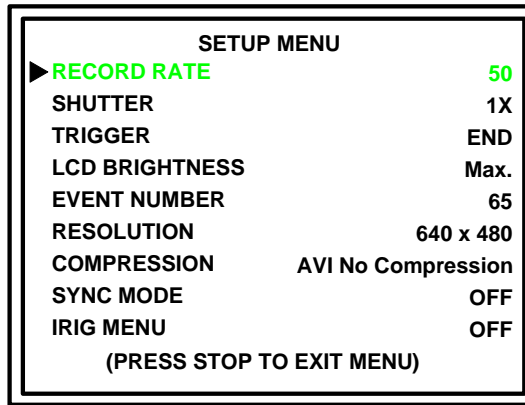

Figure 3-6: Configuration Screen, Setup Menu

Table 3-8: Setup Menu Configuration Settings and Description

Setting	Description
RECORD RATE	Set record speed in frames per second.
SHUTTER	Set shutter speed.
TRIGGER	Select camera trigger.
LCD BRIGHTNESS	Adjust LCD screen brightness from minimum to maximum.
EVENT NUMBER	Set a record/capture event number <input type="checkbox"/> Each recording is given an automatically incrementing event number. The event number can be changed by using the FUNCTION and SELECT buttons in the SETUP menu.
RESOLUTION	Set camera resolution.
COMPRESSION	Set compression for MPEG, No AVI compression available.
SYNC MODE	Set camera sync mode to Master, Slave, Off <input type="checkbox"/> Allow two or more cameras to be synchronized for 2-dimensional or 3-dimensional image capture.
IRIG MENU	Activate IRIG input mode. <input type="checkbox"/> IRIG is an acronym for Inter Range Instrumentation Group. <input type="checkbox"/> The IRIG timing protocol is used by the US military to embed millisecond timing information in the image stream.

3.3.2. Info Menu Commands

Figure 3-7 shows the INFO menu and current configuration settings. Table 3-8 provides a brief description of commands and displays.

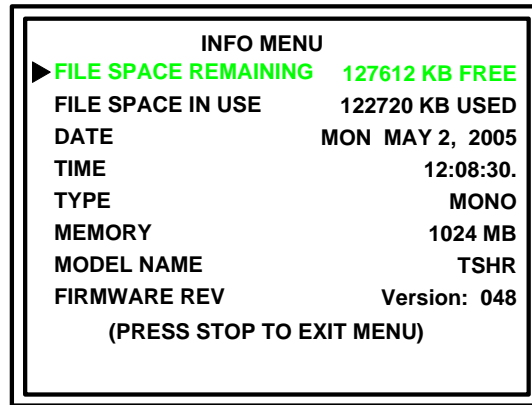

Figure 3-7: Configuration Screen, Info Menu

Table 3-9: Info Menu Configuration Settings, Displays, and Description

Setting/Display	Description
FILE SPACE REMAINING	Display the file space remaining on the compact flash card.
FILE SPACE IN USE	Display the file space used on the compact flash card.
DATE	Display the Date setting. Change the Date setting on the next configuration screen
TIME	Display the Time setting Change the Time setting on the next configuration screen
TYPE	Display the model/sensor type.
MEMORY	Display the amount of on-board memory.
MODEL NAME	Display the camera model name.
FIRMWARE REV	Display the firmware version number

3.3.3. Set Date/Time Menu Commands

Figure 3-8 shows the SET DATE / TIME menu and current configuration settings. Table 3-10 provides a brief description of commands and displays.

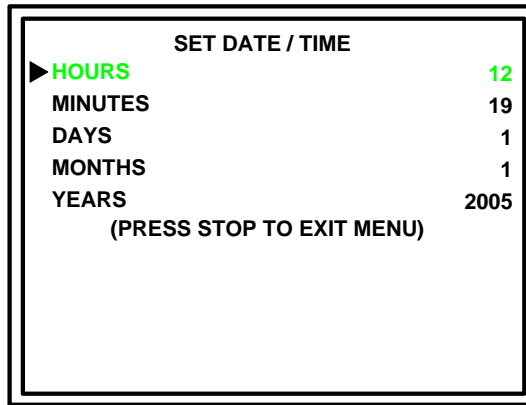

Figure 3-8: Configuration Screen, Set Date / Time Menu

Table 3-10: Set Date / Time Menu Configuration Settings and Description

Setting	Description
HOURS	Set hours value (24 hour clock)
MINUTES	Set minutes value
DAYS	Set day of month value
MONTHS	Set month value
YEARS	Set year value

3.3.4. Default Setting Menu Commands

Figure 3-9 shows the DEFAULT menu and current configuration settings. Table 3-11 provides a brief description of commands and displays.

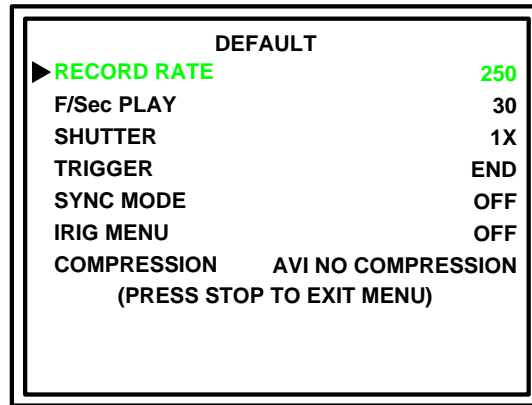

Figure 3-9: Configuration Screen, Default Menu

Table 3-11: Default Menu Configuration Settings, Displays, and Description

Setting/Display	Description
RECORD RATE	Set default record rate in frames per second.
F/sec PLAY	Set default playback rate.
SHUTTER	Set default shutter speed.
TRIGGER	Set the default record trigger point.
SYNC MODE	Set default
IRIG MENU	Set IRIG mode On or Off.
COMPRESSION	Set compression On for MPEG1 files. AVI files are not compressed.

3.3.5. File Review Menu Commands

This is the only configuration menu that is **not** available when the SETUP button is pressed.

To access this menu, press the **DOWNLOAD** button while in the **RECORD** mode. Once open, this menu displays a number of soft keys that allow you to review and delete AVI files saved on the camera compact flash card.

Figure 3-9 shows the DEFAULT menu and current settings. Table 3-12 provides a brief description of menu soft keys.

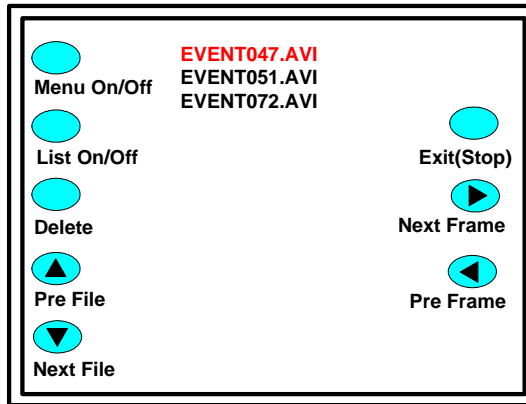

Figure 3-10: Configuration Screen, File Review Menu

Table 3-12: File Review Menu Soft Keys

Command	Function
Menu On/Off	Toggle the DOWNLOAD button to turn the soft key display On and Off.
List On/Off	Toggle the SETUP button to turn the AVI file list On and Off.
Delete	Press the FUNCTION button to delete the file highlighted in red.
Pre File	Press the ▼ SELECT button to display the previous AVI file stored on the compact flash card.
Next File	Press the ▲ SELECT button to display the next AVI file stored on the compact flash card.
Exit(Stop)	Press the STOP button to exit the File Review menu.
Next Frame	Press the ▶ PLAY button to increment displayed frames. Hold down the ▶ PLAY button to scroll frames.
Pre Frame	Press the ◀ PLAY button to decrement displayed frames. Hold down the ◀ PLAY button to scroll frames.



4. Camera Operational Procedures

This chapter contains camera operational procedures for both handheld and remote controlled camera applications. Use the callouts in Figure 4-1 to locate the control buttons on your specific camera. For example, a reference to (Figure 4-1: A) refers to the camera **Power** button of any camera in Figure 4-1.

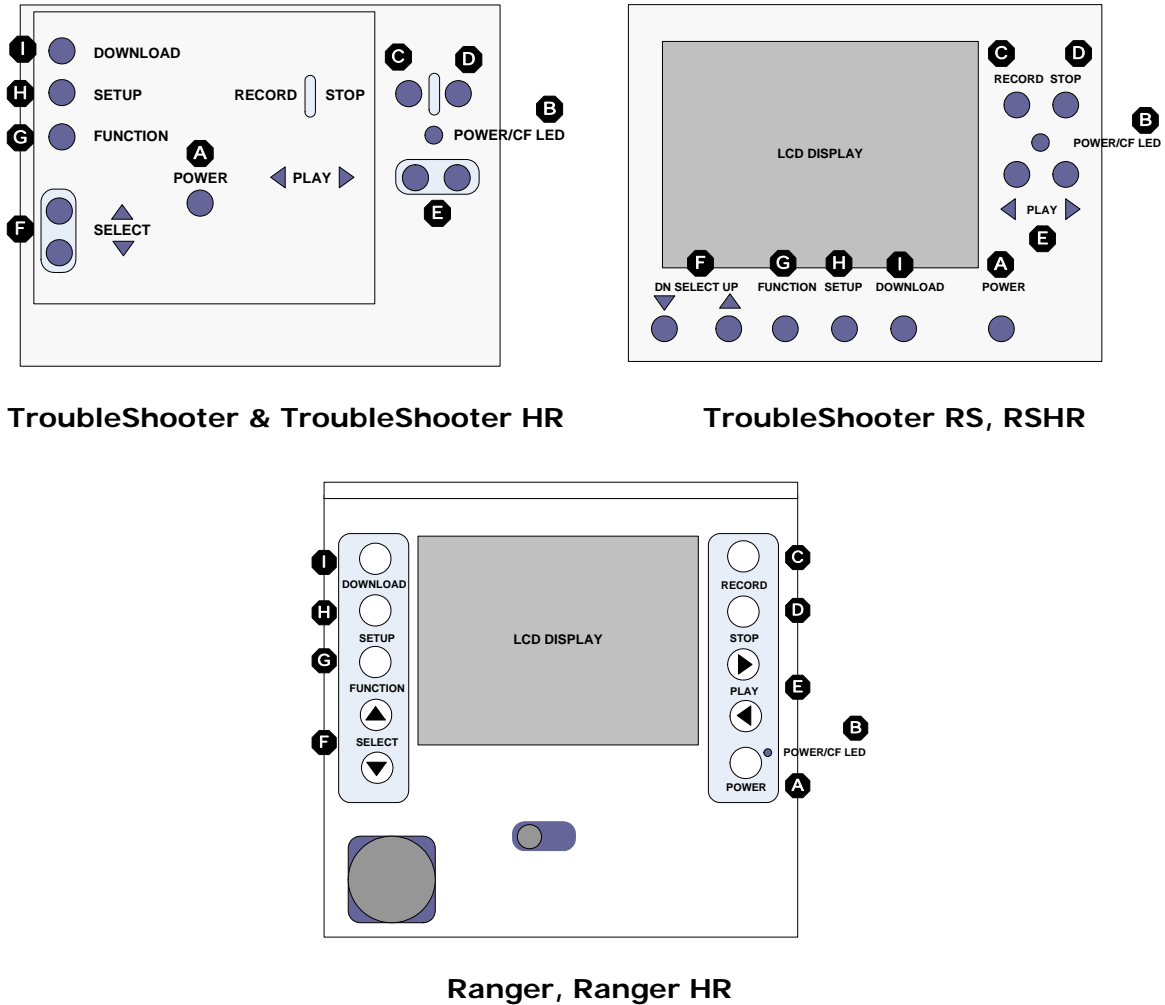

Figure 4-1: Camera Operational Controls

Before you begin any of the following procedures, ensure that your camera has been setup and configured properly. If you need to review camera configuration procedures, refer to Chapter 2, Camera Setup and Chapter 3, Camera Configuration.

4.1. Handheld Camera Operational Procedures

The following procedures contain instructions for handheld operation of the camera.

4.1.1. How to Setup the Camera for Handheld Operation

- Step 1** Remove the lens receptacle cover and install a C Mount lens.
 - Shorter focal length lens = greater field of view and depth of field (image sharpness).

- Step 2** Set the lens iris to the fully open position.
 - Smallest number on the lens aperture ring.

- Step 3** Connect power to the camera.
 - AC/DC power supply
 - Four D Cell Batteries

- Step 4** Raise the LCD display.

- Step 5** Press the **POWER** button (Figure 4-1: A).
 - After a few seconds, the camera wakes up in record mode
 - Images are stored in a circular memory buffer
 - The camera stays in record mode until a stop signal is received

Use this area to record notes regarding your application.

4.1.2. How to Record an Event

- Step 1** After performing camera setup, position the camera to capture an event.

- Step 2** Focus the lens and adjust the lens aperture setting.
 - Smaller aperture setting = greater depth of field.
 - Greater lens-to-object distance = greater depth of field.

- Step 3** Press the **Record** button (Figure 4-1: C) if the camera is not in the record mode.

- Step 4** After an event occurs, press the **STOP** button (Figure 4-1: D) to capture the event and exit the record mode.
NOTE: Default settings:
 - Shutter speed = 1X
 - Record rate = 250 Frames per second
 - Standard camera memory (2184 frames) stores 8.7 seconds of video
 - Enhanced camera memory (4368 frames) stores 17.4 seconds of video
 - Trigger = End

- Step 5** If you need to recapture the event, press the **RECORD** button (Figure 4-1: C) and repeat previous step.

Use this area to record notes regarding your application.

4.1.3. How to Playback an Event Stored in Camera Memory

- Step 1** After capturing an event, press the **PLAY** button (Figure 4-1: E) to observe the stored event.
- = Increment frames, start with the earliest frame stored in memory.
 - ◀ = Decrement frames, start with the most recent frame stored in memory (0000).
- Step 2** Use the **SELECT** buttons (Figure 4-1: F) to increase or decrease the Frames/Second displayed.
- Default setting: Frames/Second = 30
- Step 3** Images in memory are displayed in a continuous loop until the **STOP** button (Figure 4-1: D) is pressed.

Use this area to record notes regarding your application.

4.1.4. How to Save an Event Stored in Camera Memory as an AVI File on the Compact Flash Card

In many cases, only a small subset of images will contain the event of interest. To conserve memory space, attempt to save only the event of interest.

- Step 1** After capturing an event, open the CF (compact flash) access door and insert a CF card.
- When the CF card is inserted correctly, the Power On/CF Active LED (Figure 4-1: B) will flash red.
- Step 2** Using the **SELECT** buttons (Figure 4-1: F), set F/Sec to **STEP** mode (Figure 4-1: 4).
- Step 3** Press the **FUNCTION** button (Figure 4-1: G) once to highlight the frame marker Floating menu command. It will be displayed as an **F**: in the lower left corner of the display.

- Step 4** Using the **PLAY** buttons (Figure 4-1: E), display the first frame of the recorded event of interest.
- In many cases, only a small subset of memory frames will contain the event of interest.
 - Toggle the **PLAY** buttons to step one frame at a time.
 - Hold down the **PLAY** buttons to fast forward or reverse frames.

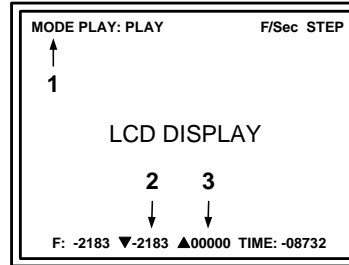

Figure 4-2: Setting Save Limits

- Step 5** Press the ▼ **SELECT** button (Figure 4-1: F) to mark the first frame (Figure 4-2: 2) to be saved to the CF card.
- Step 6** Using the **PLAY** buttons (Figure 4-1: E), display the last frame (Figure 4-2: 3) of the recorded event of interest.
- Step 7** Press the ▲ **SELECT** button (Figure 4-1: F) to mark the last frame (Figure 4-2: 3) to be saved to the CF card.
- Step 8** Press the **DOWNLOAD** button (Figure 4-1: I) to save marked frames as an AVI file on the CF card.
- The saved AVI file is named according to the event number of the recorded data
 - The **Power ON/CF Active** LED stays red while the images are being downloaded to the CF card
 - Frames can be stored in AVI or MPEG (Optional) formats
 - MotionMeasure software does not open MPEG files
 - MPEG frame = 25KB of memory
 - AVI frame = 300KB of memory
 - Available memory space on the CF card can be checked in the Setup Menu

Use this area to record notes regarding your application.

4.1.5. How to Playback an Event AVI File Stored on the Compact Flash Card

- Step 1** While in the Record mode, press the **DOWNLOAD** button (Figure 4-1: I) to open the File Review menu.
- Step 2** Use the **▲** or **▼ SELECT** buttons (Figure 4-1: F) to choose a stored event file to display.
- Step 3** Use the **▶** or **◀ PLAY** buttons (Figure 4-1: E) to increment or decrement displayed frames.
- Step 4** Additional File Review menu commands:
 - Toggle the **DOWNLOAD** button (Figure 4-1: I) to hide or display the File Review menu options.
 - Toggle the **SETUP** button (Figure 4-1: H) to hide or display all non-highlighted event file.
 - Press the **FUNCTION** (Figure 4-1: G) button to delete the highlighted file.Refer to Table 3-12 for more information on the File Review menu soft keys.
- Step 5** To close the **FILE REVIEW** menu, press the press the **STOP** button (Figure 4-1: D).

Use this area to record notes regarding your application.

4.2. Remote Camera Operational Procedures

CamLink is a single window application used to remotely operate multiple cameras. CamLink is located on the CD ROM that came with your camera.

CamLink provides the following:

- ❑ A direct interface to Fastec Imaging cameras via the USB interface.
- ❑ All the controls needed to configure and operate multiple Fastec Imaging cameras (up to 23) from your computer.
- ❑ Features a full size viewfinder window.

Figure 4-3 shows the CamLink window. Table 4-1 provides a brief description of the CamLink window buttons and displays. Refer to the *MotionMeasure Suite Operator's Manual* for more detailed information regarding CamLink.

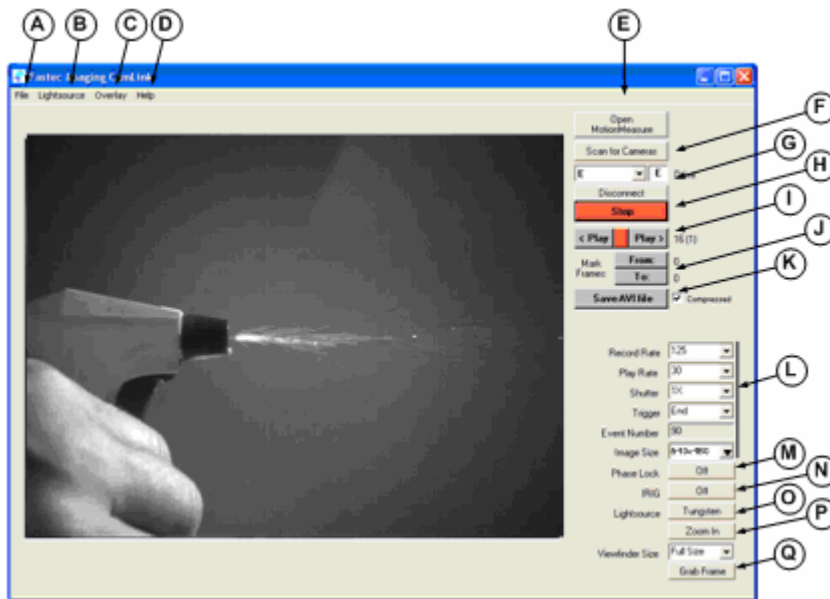

Figure 4-3: CamLink Window Buttons and Displays

Table 4-1: CamLink Window Buttons and Displays

Option	Description
A File	Open MotionMeasure, Close CamLink.
B Lightsource	Match camera color processing constants to external lighting or force an auto whitebalance on the image received from the camera.
C Overlay	Load/Clear user supplied screen overlays.
D Help	Open the Help utility program.
E Open MotionMeasure	Open MotionMeasure application.

Option	Description
F Scan for Camera (23 Maximum)	Scan system for connected camera(s). <input type="checkbox"/> Remove any Compact Flash cards before scanning.
G Disconnect	Disconnect CamLink from the camera.
H Record/Stop	Record (store frames), Stop recording.
I Play Rev/Stop/Fwd	Replay image frame data.
J Mark Frames From/To	Mark range of frames to be saved.
K Save AVI File	Save marked frames as an AVI file.
L Camera Settings	Remotely change camera operational settings: <input type="checkbox"/> Record and Play Rates <input type="checkbox"/> Shutter <input type="checkbox"/> Trigger <input type="checkbox"/> Image Size (640x480 or 320x240)
M Phase Lock	Synchronize multiple cameras to record an event from different angles.
N IRIG	Synchronize camera to external IRIG standardized time code.
O Lightsource	Match camera color processing constants to external lighting.
P Zoom In/Out	Zoom in/out on viewfinder window.
Q Grab Frame	Copy currently displayed frame to the windows clipboard.

Use this area to record notes regarding your application.

4.2.1. How to Setup to Remotely Operate the Camera

- Step 1** Install MotionMeasure/CamLink software on your computer.
- Step 2** Connect power to the camera.
- Step 3** Remove Compact Flash card from the camera.
- Step 4** Using a USB cable, connect the camera to your computer USB port.
- Step 5** Raise the LCD display.
- Step 6** Press the camera **POWER** button.

If the MotionMeasure software was installed correctly, a window opens indicating connection with the host showing the camera as a removable drive.

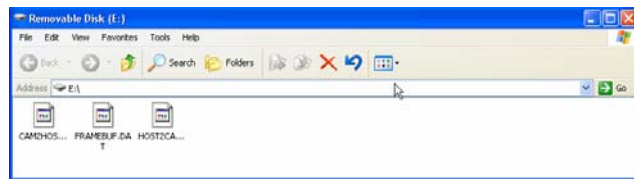

Figure 4-4: Camera Displayed as a Removable Drive

- Step 7** Position and focus the camera to capture an event.

Use this area to record notes regarding your application.

4.2.2. How to Use CamLink to Remotely Record an Event

- Step 1** Double-click on the **CamLink** desktop icon.
- Step 2** Click on the **Scan for Cameras** button (Figure 4-3: F)
- Step 3** Click on the desired camera drive letter (Figure 4-3: F).
- Step 4** Change camera default control parameters as required (Figure 4-3: L-O).
- Step 5** Left-click on the **Record** button (Figure 4-3: H) to begin storing images in camera DRAM memory and display live image on the computer screen.
- Step 6** Click the red **Stop** button (Figure 4-3: H) to stop storing images.
- Step 7** If you need to recapture the event, repeat steps 5 and 6.

Use this area to record notes regarding your application.

4.2.3. How to Use CamLink to Remotely Playback an Event Stored in Camera Memory

- Step 1** Set **Play Rate** to the desired speed (Figure 4-3: L).

- Step 2** Press the **Play** buttons (Figure 4-3: I) to observe the stored event in camera memory.
 - Play** > = Increment frames, start with the earliest frame stored in memory (-2183 or -4367).
 - < **Play** = Decrement frames, start with the most recent frame stored in memory (-0000).
 - If Play Rate is not in **Step** mode, use the red **Stop** button between Play buttons to stop playback.

- Step 3** Note the beginning and ending frame numbers of the stored event of interest.

- Step 4** Images in memory are displayed in a continuous loop until the red **Stop** button (Figure 4-3: H) is pressed.

Use this area to record notes regarding your application.

4.2.4. How to Use CamLink to Save an Event Stored in Camera Memory as an AVI File on the PC Hard Drive

- Step 1** Set **Play Rate** (Figure 4-3: L) to a speed that will allow you to closely mark the first and last frame of event of interest.
 - In many cases, only a small subset of memory frames will contain the event of interest.

- Step 2** Use the **Play** buttons (Figure 4-3: I), display the first frame of the stored event of interest.

- Step 3** Click the **From:** button (Figure 4-3: J) to mark the first frame.

- Step 4** Using the **Play** buttons (Figure 4-3: I), display the last frame of the stored event interval of interest.

- Step 5** Click the **To:** button (Figure 4-3: J) to mark the last frame.

- Step 6** Press the **Save AVI File** button (Figure 4-3: K) to save the marked frame interval as an AVI file on the computer.
 - The Save AVI File button stays red while the images are being saved to the AVI file. Default format is compressed file.

Use this area to record notes regarding your application.

5. Index

C

- Camera Operational Procedures
 - Camera Controls, 4-1
- Camera Overviews, 1-1
- Configuration Screen
 - Default Menu, 3-12
 - File Menu, 3-13
 - Info Menu, 3-10
 - Setup Menu, 3-9
 - Time Menu, 3-11
- Configuration Screen Menus, 3-8

F

- Floating Configuration Menu
 - Record Mode, 3-6
- Floating Configuration Playback and Stopped Mode, 3-7

H

- Handheld Operation
 - How to Playback an Event Stored in Camera Memory, 4-4
 - How to Playback an Event Stored on the CF Card, 4-6
 - How to Record an Event, 4-3
 - How to Save an Event on the CF Card, 4-4
- Handheld Operation
 - How to Setup the Camera for Handheld Operation, 4-2
 - Overview, 4-2
- help, 1-11

I

- Installation
 - Camera batteries, 2-2
 - Camera to Computer, 2-5
 - Compact Flash Card, 2-3
 - External Power Supply, 2-2
 - Getting Started, 2-1
 - Lens, 2-1
 - Remote Configuration, 2-5

M

- MODE FOCUSING, 3-6
- MODE PLAY ZOOM: STOPPED, 3-7
- MODE PLAY: <====>, 3-7
- MODE PLAY: STOPPED, 3-7
- MODE RECORD, 3-6
- MODE WINDOWING, 3-6
- MotionMeasure, 1-11
- MotionMeasure Software Suite, 1-11

R

- Ranger and HR
 - Back Panel, 1-10
 - Connector Panel, 1-10
 - Display, 1-9
 - Introduction, 1-8
 - Specs, 1-8
- Remote Camera Operation
 - How to Use CamLink to Remotely Playback an Event Stored in Camera Memory, 4-11
 - How to Use CamLink to Save an Event Stored in Camera Memory as an AVI File on the PC Hard Drive, 4-12
- Remote Camera Operation
 - How to Use CamLink to Remotely Record an Event, 4-10
 - Overview, 4-9
- Resources, iv

S

- Shutter Speed Settings, 3-1
- Software
 - Suite, 1-11
 - update, 1-11
 - version, 1-11
 - web, 1-11

T

- Technical Keypoints
 - Internal Trigger, 3-3
 - Phase Lock Multiple Cameras, 3-5
 - Record Time Matrix, 3-2
 - Remote Trigger, 3-3
 - Shutter Multiplier, 3-1
 - Sync In/Out, 3-4
- TroubleShooter and HR
 - Back Panel, 1-3, 1-5
 - Connector Panel, 1-4
 - Display, 1-3
 - Introduction, 1-2
 - Specs, 1-2
- TroubleShooter RS and HR
 - Back Panel, 1-6
 - Connector Panel, 1-7
 - Display, 1-6
 - Introduction, 1-5
 - Specs, 1-5

U

- Unpack camera, 2-1





Artisan Technology Group is your source for quality new and certified-used/pre-owned equipment

- FAST SHIPPING AND DELIVERY
- TENS OF THOUSANDS OF IN-STOCK ITEMS
- EQUIPMENT DEMOS
- HUNDREDS OF MANUFACTURERS SUPPORTED
- LEASING/MONTHLY RENTALS
- ITAR CERTIFIED SECURE ASSET SOLUTIONS

SERVICE CENTER REPAIRS

Experienced engineers and technicians on staff at our full-service, in-house repair center

*InstraView*SM REMOTE INSPECTION

Remotely inspect equipment before purchasing with our interactive website at www.instraview.com ↗

WE BUY USED EQUIPMENT

Sell your excess, underutilized, and idle used equipment. We also offer credit for buy-backs and trade-ins. www.artisanng.com/WeBuyEquipment ↗

LOOKING FOR MORE INFORMATION?

Visit us on the web at www.artisanng.com ↗ for more information on price quotations, drivers, technical specifications, manuals, and documentation

Contact us: (888) 88-SOURCE | sales@artisanng.com | www.artisanng.com