



Artisan Technology Group is your source for quality new and certified-used/pre-owned equipment

- FAST SHIPPING AND DELIVERY
- TENS OF THOUSANDS OF IN-STOCK ITEMS
- EQUIPMENT DEMOS
- HUNDREDS OF MANUFACTURERS SUPPORTED
- LEASING/MONTHLY RENTALS
- ITAR CERTIFIED SECURE ASSET SOLUTIONS

SERVICE CENTER REPAIRS

Experienced engineers and technicians on staff at our full-service, in-house repair center

*InstraView*SM REMOTE INSPECTION

Remotely inspect equipment before purchasing with our interactive website at www.instraview.com ↗

WE BUY USED EQUIPMENT

Sell your excess, underutilized, and idle used equipment. We also offer credit for buy-backs and trade-ins. www.artisanng.com/WeBuyEquipment ↗

LOOKING FOR MORE INFORMATION?

Visit us on the web at www.artisanng.com ↗ for more information on price quotations, drivers, technical specifications, manuals, and documentation

Contact us: (888) 88-SOURCE | sales@artisanng.com | www.artisanng.com

USB-1208FS/LS/1408FS Series

12-bit and 14-bit Multifunction Devices with 8 AI, 2 AO



Features

- Low cost, multifunction USB devices with 4 differential or 8 single-ended analog inputs (software-selectable)
- Provides 12-bit or 14-bit analog input resolution
- Maximum sample rates ranging from 1.2 kS/s to 50 kS/s
- 2 analog outputs
- 16 digital I/O
- One 32-bit counter input channel
- No external power required
- All models available with enclosure and screw terminals
- USB-1208FS-Plus-OEM and USB-1408FS-Plus-OEM also available as board-only versions with header connectors (no case, CD, or USB cable included)



Software

Supported Operating Systems

- Windows® 8/7/Vista®/XP 32/64-bit
 - Universal Library™ (UL), ULx for NI LabVIEW™
- Linux® open-source driver support
- Android™
 - UL for Android (-Plus and -OEM models only)

Ready-to-Run Applications

- InstaCal™ (install, configure, and test)
- DAQami™ Advanced Data Logging Application (acquire, view, and log)
- TracerDAQ® (acquire, view, log, and generate)

All devices in this series offer eight singled-ended or four differential analog inputs, two analog outputs, 16 digital I/O, and one counter input. The USB-1208FS-Plus/1408FS-Plus (standard and -OEM models) also include eight high-current (24 mA) digital I/O connections.

Supported Programming Environments

- Visual Studio® and Visual Studio .NET, including examples for Visual C++®, Visual C#®, Visual Basic®, and Visual Basic .NET, and other IDEs
- Java® (Android only) including examples and demo apps*
- LabVIEW (Windows only)
- DASyLab®
- MATLAB® (Data Acquisition Toolbox™)

Overview

The USB-1208FS/LS/1408FS Series consists of the low-cost analog and digital I/O devices. All of these devices offer four differential (DIFF) or eight single-ended (SE) analog inputs, two analog outputs, 16 digital I/O channels, and one counter input.

USB-1208FS/LS/1408FS Series Selection Chart					
Specification	USB-1208LS	USB-1208FS	USB-1208FS-Plus USB-1208FS-Plus-OEM	USB-1408FS	USB-1408FS-Plus USB-1408FS-Plus-OEM
Analog Input	8 SE/4 DIFF	8 SE/4 DIFF	8 SE/4 DIFF	8 SE/4 DIFF	8 SE/4 DIFF
Maximum Sample Rate	1.2 kS/s	50 kS/s	50 kS/s	48 kS/s max	48 kS/s max
Analog Outputs	2	2	2	2	2
Concurrent AI/AO Scanning Operations	–	–	✓	–	✓
Digital Output	±2.5 mA per Pin	±6.0 mA per Pin	±6.0 mA per Pin (Port A) ±24.0 mA per Pin (Port B)	±6.0 mA per Pin	±6.0 mA per Pin (Port A) ±24.0 mA per Pin (Port B)
Event Counters	1	1	1	1	1
DAQami Support	✓	✓	✓	✓	✓
UL for Android Support	–	–	✓	–	✓

USB-1208FS/LS/1408FS Series

General Information



Analog Input

USB-1208LS/1208FS/1208FS-Plus/USB-1208FS-Plus-OEM: These devices provide eight, 11-bit SE analog inputs or four, 12-bit DIFF analog inputs.

USB-1408FS/1408FS-Plus/ USB-1408FS-Plus-OEM: These devices provide eight, 13-bit SE analog inputs or four, 14-bit DIFF analog inputs.

All devices support software-selectable ranges that provide inputs from ± 1 V to ± 20 V in a DIFF configuration, and ± 10 V in a SE configuration.

Sample Rate

USB-1208LS: When scanning in hardware-paced mode, the USB-1208LS can sample at a maximum of 1.2 kS/s. BURSTIO mode into the 4 kS FIFO is also available at rates up to 8 kS/s.

USB-1208FS/1208FS-Plus, USB-1408FS/1408FS-Plus, and -OEM Models: When scanning in hardware-paced mode, the USB-1208FS/1208FS-Plus can sample at a maximum of 50 kS/s, and the USB-1408FS/1408FS-Plus can sample at a maximum of 48 kS/s.

Channel-Gain Queue

The channel-gain queue feature lets you configure a list of channels and gains for each scan. Each channel can have a different gain setting. The gain settings are stored in a channel-gain queue list that is written to local memory on the device.

The USB-1208LS channel-gain queue list can contain up to eight channels in SE mode and up to four channels in DIFF mode. The channels can be listed in any order.

The USB-1208FS and USB-1408FS channel-gain queue can contain up to 16 channels listed in any order.

The USB-1208FS-Plus and USB-1408FS-Plus channel-gain queue can contain up to eight unique channels in SE mode and up to four unique channels in DIFF mode. The channels can be non-consecutive, but must be listed in increasing order.

Analog Output

The maximum analog output update rate for all devices depends on several factors, including USB port speed.

USB-1208LS: This device offers two 10-bit analog outputs with a range of 0 V to 5 V.

One analog output updates at a maximum rate of 100 S/s; two analog outputs update at a maximum rate 50 S/s each. The USB-1208LS updates in software-paced mode only.

USB-1208FS and USB-1408FS: Both devices offer two 12-bit analog outputs with a range of 0 V to 4.096 V.

When updating continuously from computer memory (hardware-paced mode), one analog output updates at a maximum rate of 10 kS/s; two analog outputs update simultaneously at a maximum rate of 5 kS/s each.

USB-1208FS-Plus, USB-1408FS-Plus, and -OEM Models: Both devices offer two 12-bit analog outputs with a range of 0 V to 5 V.

When updating continuously from computer memory (hardware-paced mode), the analog outputs update at a maximum rate of 50 kS/s per channel.

Concurrent AI/AO Scanning Operations (-Plus and -OEM Models Only)

The USB-1208FS-Plus, USB-1408FS-Plus, USB-1208FS-Plus-OEM and USB-1408FS-Plus-OEM all support executing an analog input scan and analog output scan at the same time.

Digital I/O

All devices provide 16 TTL-level digital I/O lines. Digital I/O can be programmed on each 8-bit port (Port A and Port B) for either input (default) or output.

USB-1208FS-Plus, USB-1408FS-Plus and -OEM Models: Port B0 through Port B7 are high-current drive (24 mA) digital I/O connections.

Event Counter Input

Each device supports one 32-bit TTL-level counter that accepts inputs up to 1 MHz.

-Plus-OEM Versions

The USB-1208FS-Plus-OEM and USB-1408FS-Plus-OEM have a board-only form factor with header connectors for OEM and embedded applications (no case, CD, or USB cable included). All devices can be further customized to meet customer needs.



The USB-1208FS-Plus-OEM and USB-1408FS-Plus-OEM have the same specifications as the USB-1208FS-Plus and USB-1408FS-Plus.







USB-1208FS/LS/1408FS Series

Software Information

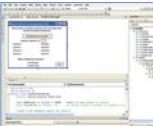

Software Support

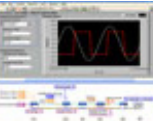
USB-1208FS/LS/1408FS Series devices are supported by the software in the table below.

Ready-to-Run Applications		
InstaCal		An interactive utility that configures and tests MCC hardware. Windows® OS InstaCal is included with the free MCC DAQ Software bundle (CD/download).
DAQami		Advanced data logging application with drag-and-drop software interface that is used to acquire, view, and log data. DAQami can be configured to log analog channels and to view that data in real-time or post-acquisition on user-configurable displays. Windows OS DAQami is available as a purchased software download.
TracerDAQ and TracerDAQ Pro		A virtual strip chart, oscilloscope, function generator, and rate generator applications used to generate, acquire, analyze, display, and export data. The Pro version provides enhanced features. Windows OS TracerDAQ is included with the free MCC DAQ Software bundle (CD/download). TracerDAQ Pro is available as a purchased software download.
General-Purpose Programming Support		
Universal Library (UL)		Programming library of function calls for C, C++, VB, C# .Net, and VB .Net using Visual Studio and other IDEs. Windows OS The UL is included with the free MCC DAQ Software bundle (CD/download).
UL for Android (-Plus and -OEM models only)		Programming library of function calls for Java programmers who develop apps for Android-based tablets and phones. UL for Android communicates with select MCC DAQ devices. Supports Android project development on Windows, Linux, Mac OS X UL for Android is included with the free MCC DAQ Software bundle (CD/download).
Linux Driver		Open-source Linux drivers are available for most MCC devices. Example programs are also provided.
Application-Specific Programming Support		
ULx for NI LabVIEW		A comprehensive library of VIs and example programs for NI LabVIEW that is used to develop custom applications that interact with most MCC devices. Windows OS ULx is included with the free MCC DAQ Software bundle (CD/download).
DASYLab Driver		Icon-based data acquisition, graphics, control, and analysis software that allows users to create complex applications in minimal time without text-based programming. DASYLab is available as a purchased software download. Windows OS
MATLAB Driver		High-level language and interactive environment for numerical computation, visualization, and programming. The Data Acquisition Toolbox, provided by The Mathworks, allows users to acquire data from most MCC PCI and USB devices. Visit www.MathWorks.com for more information on MATLAB Data Acquisition Toolbox support.

USB-1208FS/LS/1408FS Series

Specifications

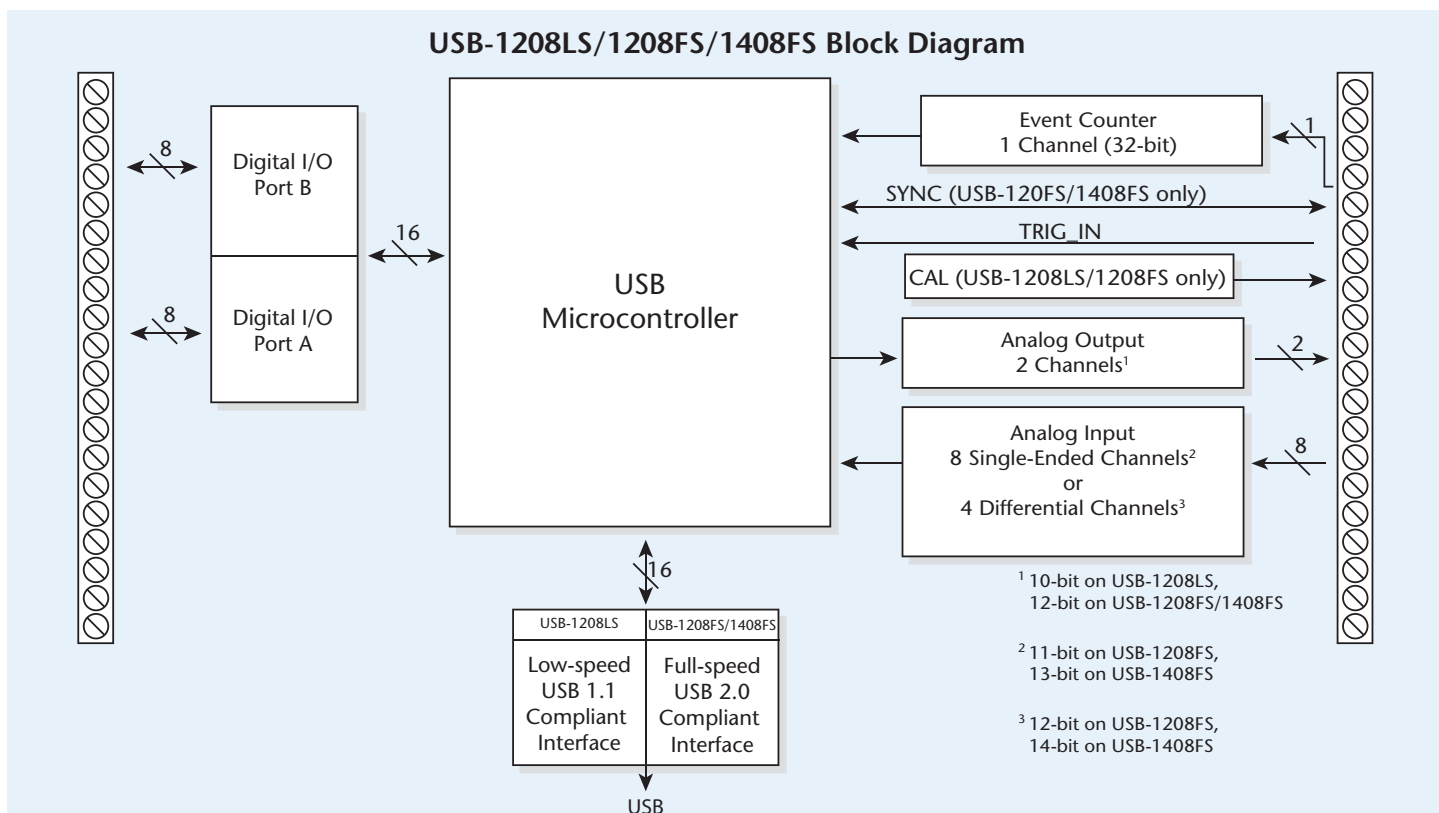

Specifications

These specifications apply to both standard and OEM versions unless noted otherwise..

General

Environment

- Operating temperature: 0 °C to 70 °C
- Storage temperature: -40 °C to 70 °C
- Relative humidity: 0% to 90% non-condensing

Communications

- USB-1208LS: USB 1.1 low-speed mode (1.5 Mbps)
- USB-1208FS/1208FS-Plus/1408FS/1408FS-Plus: USB 2.0 full-speed mode (12 Mbps)

Acquisition data buffer (USB-1208LS only): 4 kS

Signal I/O connector

- OEM models: Two 20-pin, 0.1 in. pitch headers
- All other devices: 2 banks of screw-terminal blocks

Dimensions (L x W x H)

- OEM models: 81.28 x 70.36 x 13.72 mm (3.20 x 2.77 x 0.54 in.)
- All other devices: 79 x 82 x 27 mm (3.20 x 3.10 x 1.05 in.)

Analog Input

A/D converter type: Successive approximation

Channels: 8 SE or 4 DIFF, programmable as SE or DIFF

Input common-mode voltage range for linear operation

- SE Mode: CHx to GND, ±10 V max
- DIFF Mode: CHx to GND, -10 V min, 20 V max

Absolute maximum input voltage

- USB-1208LS: CHx to GND, ±40 V max
- USB-1208FS/1208FS-Plus/1408FS/1408FS-Plus: CHx to GND, ±28 V max

Input impedance: 122 kΩ

Input current

Input current is a function of applied voltage on the analog input channels.

For a given input voltage, V_{in} , the input leakage is approximately equal to

$(8.181 * V_{in} - 12) \mu A$

$V_{in} = 10 V, 70 \mu A$ typ

$V_{in} = 0 V, -12 \mu A$ typ

$V_{in} = -10 V, -94 \mu A$ typ

Ranges: Software or selectable on a per-channel basis

SE mode: ±10 V

DIFF mode: ±20 V, ±10 V, ±5 V, ±4 V, ±2.5 V, ±2.0 V, ±1.25 V, ±1.0 V

Throughput

Maximum throughput scanning to computer memory depends on the computer being used.

USB-1208LS

Software paced: 50 S/s typ, system-dependent

Hardware paced: 1.2 kS/s

BURSTIO to 4 kS FIFO: 8 kS/s

USB-1208FS/1208FS-Plus

Software paced: 250 S/s typ, system-dependent

Hardware paced: 50 kS/s

USB-1408FS/1408FS-Plus

Software paced: 250 S/s typ, system-dependent

Hardware paced: 48 kS/s

Channel gain queue

USB-1208LS/1208FS-Plus/1408FS-Plus: Up to 8 elements, software-selectable channel and range

USB-1208FS/1408FS: Up to 16 elements, software-selectable channel and range

USB-1208FS/LS/1408FS Series Specifications



USB-1208FS-Plus, USB-1408FS-Plus, and -OEM Models Block Diagram

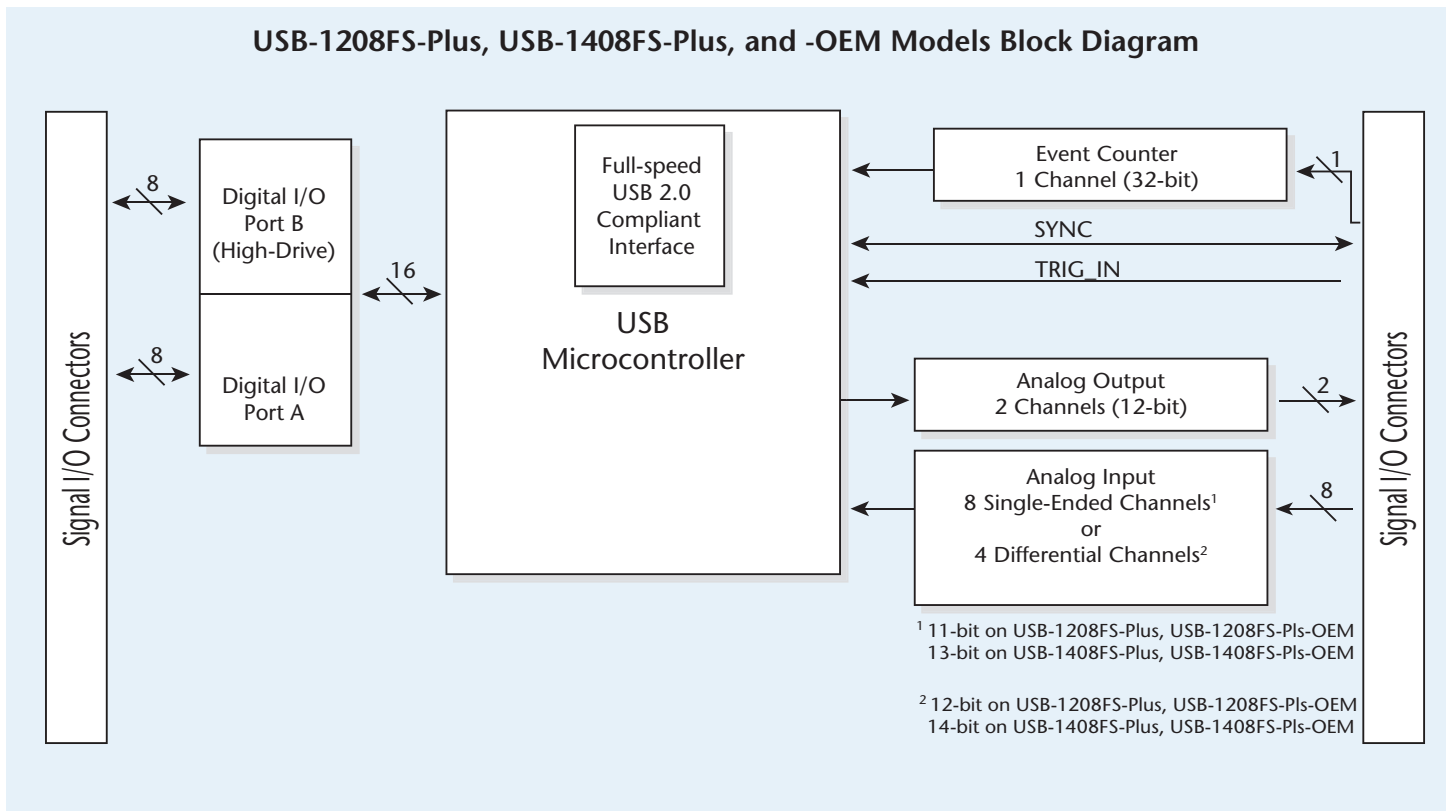

Resolution

- USB-1208LS/1208FS/1208FS-Plus**
 - DIFF: 12 bits, no missing codes
 - SE: 11 bits (the AD7870 converter only returns 11-bits (0-2047 codes) in SE mode)
- USB-1408FS/1408FS-Plus**
 - DIFF: 14 bits, no missing codes
 - SE: 13 bits (the AD7871 converter only returns 13-bits (0-8192 codes) in SE mode)

CAL accuracy

- USB-1208LS: CAL = 2.5 V, $\pm 0.05\%$ typ, $\pm 0.25\%$ max
- USB-1208FS: CAL = 2.5 V, ± 36.25 mV max

Integral linearity error

- USB-1208LS/1208FS/1208FS-Plus: ± 1 least significant bit (LSB) typ

- USB-1408FS/1408FS-Plus: ± 2 LSB typ

- Differential linearity error: ± 0.5 LSB typ

- Repeatability: ± 1 LSB typ

CAL current (USB-1208LS/1208FS Only)

- Source: 5 mA max

Sink

- USB-1208LS: 20 μ A min, 200 nA typ
- USB-1208FS: 20 μ A min, 100 μ A typ

Absolute accuracy long term drift (USB-1408FS/1408FS-Plus only)

- Extrapolating the long term drift accuracy specifications provides the approximate long term drift of the USB-1408FS intermediate input ranges.

- ± 20 V range: ± 3 LSB typ ($\Delta t = 1000$ hrs)

- ± 4 V range: ± 6 LSB typ ($\Delta t = 1000$ hrs)

- ± 1 V range: ± 8 LSB typ ($\Delta t = 1000$ hrs)

2.5VREF accuracy (USB-1408FS Only)

- ± 36.25 mV max

2.5VREF output current (USB-1408FS/1408FS-Plus only)

- Source: 5 mA max

- Sink: 20 μ A min, 100 μ A typ

Trigger source (software-selectable)

- External digital: TRIG_IN

Clock source (all devices except USB-1208LS, software-selectable)

- Internal
- External (SYNC), Rising Edge Triggered

Analog Input Accuracy USB-1208LS/1208FS/ 1208FS-Plus/USB-1208FS-Plus-OEM	
Range	Accuracy (LSB)
Differential Mode	
± 20 V	5.1
± 10 V	6.1
± 5 V	8.1
± 4 V	9.1
± 2.5 V	12.1
± 2 V	14.1
± 1.25 V	20.1
± 1 V	24.1
Single-Ended Mode	
± 10 V	4.0

USB-1208FS/LS/1408FS Series

Specifications



Analog Input Accuracy USB-1408FS/1408FS-Plus/USB-1408FS-Plus-OEM		
Range	Absolute Accuracy 25°C	Absolute Accuracy 0 to 50°C
Differential Mode		
±20 V	±10.98 mV	±49.08 mV
±10 V	±7.32 mV	±33.42 mV
±5 V	±3.66 mV	±20.76 mV
±4 V	±2.92 mV	±19.02 mV
±2.5 V	±1.83 mV	±14.97 mV
±2 V	±1.70 mV	±14.29 mV
±1.25 V	±1.21 mV	±12.18 mV
±1 V	±1.09 mV	±11.63 mV
Single-Ended Mode		
±10 V	±10.98 mV	±49.08 mV

Noise Performance USB-1408FS/1408FS-Plus/USB-1408FS-Plus-OEM		
Range	Typical Counts	Least Significant Bit- Root Mean Square (LSBRMS)
Differential Mode		
±20 V	8	1.21
±10 V	8	1.21
±5 V	9	1.36
±4 V	10	1.51
±2.5 V	12	1.81
±2 V	14	2.12
±1.25 V	18	2.72
±1 V	22	3.33
Single-Ended Mode		
±10 V	8.0	1.21

Noise Performance USB-1208FS/1208FS-Plus/USB-1208FS-Plus-OEM		
Range	Typical Counts	Least Significant Bit- Root Mean Square (LSBRMS)
Differential Mode		
±20 V	2	0.30
±10 V	2	0.30
±5 V	3	0.45
±4 V	3	0.45
±2.5 V	4	0.61
±2 V	5	0.76
±1.25 V	7	1.06
±1 V	8	1.21
Single-Ended Mode		
±10 V	2	0.30

Analog Output

Resolution

USB-1208LS: 10 bits, 1 in 1024

USB-1208FS/1208FS-Plus/1408FS/1408FS-Plus: 12 bits, 1 in 4096

Output range

USB-1208LS/1208FS-Plus/1408FS-Plus: 0 V to 5 V

USB-1208FS/1408FS: 0 V to 4.096 V, 1 mV per LSB.

Number of channels: 2

Throughput

Maximum throughput scanning to computer memory depends on the computer being used.

USB-1208LS

Software paced

Single channel: 100 S/s

Dual channel, simultaneous update: 50 S/s

USB-1208FS/1208FS-Plus/1408FS/1408FS-Plus

Software paced: 250 S/s single channel typ, system-dependent

Hardware paced

USB-1208FS/1408FS

Single channel: 10 kS/s

Dual channel: 5 kS/s

USB-1208FS-Plus/1408FS-Plus: 50 kS/s max per channel

Power On and reset voltage

USB-1208LS/1208FS/1208FS-Plus: Initializes to 000h code

USB-1408FS/1408FS-Plus: 0 V, ±20 mV typ, initializes to 000h code

Maximum voltage (USB-1208LS only)

V_s is the USB +5 V power. The maximum analog output voltage is equal to V_s at no load. V is system-dependent and may be less than 5 V.

No load: V_s

1 mA load: 0.99 * V_s

5 mA load: 0.98 * V_s

Output drive (each D/A out)

USB-1208LS: 30 mA

USB-1208FS and USB-1408FS 15 mA

USB-1208FS-Plus and USB-1408FS-Plus: 5 mA, sourcing

Slew Rate

USB-1208LS: 0.14 V/ms typ

USB-1208FS/1208FS-Plus/1408FS/1408FS-Plus: 0.8 V/μs typ

Accuracy (All Values are ±) (All Devices Except USB-1208LS)

USB-1208FS/1408FS

0 V to 4.096 V: 4.0 LSB typ, 45.0 LSB max

USB-1208FS-Plus/1408FS-Plus

0 V to 5 V: 4.0 LSB typ, 45.0 LSB max (accuracy tested at no load)

USB-1208FS/LS/1408FS Series

Specifications



Analog output accuracy components (all Values are \pm) (all devices except USB-1208LS)

USB-1208FS/1408FS

Range: 0 V to 4.096 V

USB-1208FS-Plus/1408FS-Plus

Range: 0 V to 5 V

% of FSR: 0.1 typ, 0.9 max

Gain error at full scale: 4.0 mV typ, 36.0 mV max

Offset: 1.0 mV typ, 9.0 mV max

Accuracy at FS: 4.0 mV typ, 45.0 mV max

Digital I/O

Digital type

USB-1208LS: 82C55

All other devices: CMOS

Number of I/O: 16 (Port A0 through A7, Port B0 through B7)

Configuration

2 banks of 8

USB-1208FS-Plus/1408FS-Plus: Port B is high-current drive

Pull-up/down configuration: All pins pulled up to 5 V through 47 k Ω resistors (default).

All Devices Except USB-1208LS: Change to pull-down using internal user-configurable jumpers.[†]

USB-1208LS: Positions available for pull-down to ground. Hardware-selectable through 0 Ω resistors as a factory option.

Input high voltage: 2.0 V min, 5.5 V absolute max

Input low voltage: 0.8 V max, -0.5 V absolute min, 0 V recommended min

USB-1208LS

Output high voltage (IOH = -2.5 mA): 3.0 V min

Output low voltage (IOL = 2.5 mA): 0.4 V max

USB-1208FS/1408FS

Output high voltage (IOH = -6.0 mA): 3.84 V min

Output low voltage (IOL = 6.0 mA): 0.33 V max

USB-1208FS-Plus/1408FS-Plus

Output high voltage, port A: 4.4 V min (IOH = -20 μ A),

3.84 V min (IOH = -6.0 mA)

Output low voltage, port A: 0.1 V max (IOL = 20 μ A),

0.33 V max (IOL = 6.0 mA)

Output high voltage, port B: 4.4 V min (IOH = -50 μ A),

3.76 V min (IOH = -24.0 mA)

Output low voltage, port B: 0.1 V max (IOH = 50 μ A),

0.44 V max (IOH = 24.0 mA)

Power on and reset state: Input

* USB-1208FS-Plus/1408FS/1408FS-Plus: Zero-scale offsets may result in a fixed zero-scale error producing a *dead-band* digital input code region. In this case, changes in digital input code of less than 0x040 may not produce a corresponding change in the output voltage. The offset error is tested and specified at code 0x040.

USB-1208FS: Negative offsets result in a fixed zero-scale error or *dead-band*. At the maximum offset of -9 mV, any input code of less than 0x009 does not produce a response in the output.

† USB-1208FS hardware revisions D and later, and USB-1408FS hardware with part number 193331x (where x is the revision letter) can be changed to pull-down using an internal jumper. Other revisions/part numbers can be configured at the factory for pull-down.

External Trigger

Trigger source: External digital, TRIG_IN

USB-1208LS: Schmitt trigger input protected with a 1.5 k Ω series resistor)

Trigger Mode

USB-1208LS: Level sensitive; software-selectable for TTL level high or low input

USB-1208FS/1408FS: Edge sensitive; software-selectable for CMOS compatible rising or falling edge

All other devices: Edge or level sensitive; software-selectable for CMOS compatible rising or falling edge, high or low level.

Trigger latency

USB-1208LS: BURSTIO, 25 μ s min, 50 μ s max

All other devices: 10 μ s max

Trigger pulse width

USB-1208LS: BURSTIO, 40 μ s min

All other devices: 1 μ s min

USB-1208LS

Input high voltage: 3.0 V min, 15.0 V absolute max

Input low voltage: 0.8 V max

Input leakage current: \pm 1.0 μ A

All other devices

Input type: Schmitt trigger, 47 k Ω pull-down to ground

Schmitt trigger hysteresis: 1.01 V typ, 0.6 V min, 1.5 V max

Input high voltage threshold: 2.43 V typ, 1.9 V min, 3.1 V max

Input high voltage limit: 5.5 V absolute max

Input low voltage threshold: 1.42 V typ, 1.0 V min, 2.0 V max

Input low voltage limit: -0.5 V absolute min, 0 V recommended min

External Clock Input/Output (All Devices Except USB-1208LS)

Pin name: SYNC

Pin type: Bidirectional

Direction (software-selectable)

Input (default): Receives A/D clock from external source. Active on rising edge.

Output: Outputs internal A/D clock. Active on rising edge.

Input clock rate

USB-1208FS/1208FS-Plus: 50 kHz, max

USB-1408FS/1408FS-Plus: 48 kHz, max

Clock pulse width

Input mode: 1 μ s min

Output mode: 5 μ s min

Input type: Schmitt trigger, 47 k Ω pull-down to ground

Schmitt trigger hysteresis: 1.01 V typ, 0.6 V min, 1.5 V max

Input high voltage threshold: 2.43 V typ, 1.9 V min, 3.1 V max

Input high voltage limit: 5.5 V absolute max

Input low voltage threshold: 1.42 V typ, 1.0 V min, 2.0 V max

Input low voltage limit: -0.5 V absolute min, 0 V recommended min

Output high voltage: 4.4 V min (IOH = -50 μ A), 3.80 V min (IOH = -8 mA)

Output low voltage: 0.1 V max (IOL = 50 μ A), 0.44 V max (IOL = 8 mA)

Counter

Pin name: CTR

Counter type: Event counter

Number of channels: 1

Input type

USB-1208LS: TTL, rising edge triggered

USB-1208FS/1408FS: Schmitt trigger, 47 k Ω pull-down to ground

Input Source: CTR screw terminal

Resolution: 32 bits

Maximum input frequency: 1 MHz

High pulse width: 500 ns min

Low pulse width: 500 ns min

USB-1208LS

Schmitt trigger hysteresis: 20 mV to 100 mV

Input leakage current: \pm 1 μ A

Input high voltage: 4.0 V min, 5.5 V absolute max

Input low voltage: 1.0 V max, -0.5 V absolute min

All other devices

Schmitt trigger hysteresis: 1.01 V typ, 0.6 V min, 1.5 V max

Input high voltage threshold: 2.43 V typ, 1.9 V min, 3.1 V max

Input high voltage limit: 5.5 V absolute max

Input Low voltage threshold: 1.42 V typ, 1.0 V min, 2.0 V max

Input low voltage limit: -0.5 V absolute min, 0 V recommended min

Non-Volatile Memory

USB-1208LS

Memory size: 8192 bytes

Memory configuration

Address 0x0000 to 0x17FF: Read/write access, A/D data (4 kS)

Address 0x1800 to 0x1EFF: Read/write access, user data area

Address 0x1F00 to 0x1FEF: Read/write access, calibration data

Address 0x1FF0 to 0x1FFF: Read/write access, system data

USB-1208FS/1408FS

EEPROM: 1,024 bytes

EEPROM configuration

USB-1208FS

Address 0x000 to 0x07F: Reserved access, 128 bytes system data

Address 0x080 to 0x1FF: Read/write access, 384 bytes calibration data

Address 0x200 to 0x3FF: Read/write access, 512 bytes user area

USB-1408FS

Address 0x000 to 0x1FF: Read/write access 512 bytes user area

Address 0x200 to 0x3FF: Read/write access, 512 bytes calibration data

USB-1208FS-Plus/1408FS-Plus

EEPROM: 2,048 bytes (768 bytes calibration, 256 bytes user, 1,024 bytes system data)

USB-1208FS/LS/1408FS Series

Ordering



Power†

USB-1208LS

Supply current: 20 mA (total current requirement; includes up to 5 mA for the status LED)

5 V USB power available

Connected to self-powered hub: 4.5 V min, 5.25 V max

Connected to bus-powered hub: 4.1 V min, 5.25 V max

Output current (total amount of current that can be sourced from the USB 5 V, analog outputs and digital outputs)

Connected to self-powered hub: 450 ma min, 500 ma max

Connected to bus-powered hub: 50 mA min, 100 mA max

USB-1208FS/1408FS

Supply current: 80 mA (total current requirement; includes up to 10 mA for the status LED)

5 V USB power available

Connected to self-powered hub: 4.5 V min, 5.25 V max

Connected to bus-powered hub: 4.1 V min, 5.25 V max

Output Current (total amount of current that can be sourced from the USB 5 V, analog outputs and digital outputs)

Connected to self-powered hub or externally powered

Root port hub: 420 mA max

Connected to bus-powered hub: 20 mA max

USB-1208FS-Plus/1408FS-Plus

Supply Current

During USB enumeration: < 100 mA

After USB enumeration, including DIO, AO, SYNC, and

+VO output loading: < 500 mA

+VO power available after USB enumeration: 4.5 V min, 5.25 V max

+VO output current after USB enumeration: 100 mA max

Ordering Information

Part No.	Description
USB-1208LS	USB-based data acquisition device with eight 12-bit analog inputs, 1.2 kS/s, two analog outputs, and 16 digital I/O. Includes USB cable and MCC DAQ software CD.
USB-1208FS	USB-based data acquisition device with 8 analog inputs, up to 12-bit resolution, 50 kS/s, two analog outputs, and 16 digital I/O. Includes USB cable and MCC DAQ software CD.
USB-1208FS-Plus	USB-based multifunction DAQ device with 8 SE/4 DIFF analog inputs, up to 12-bit resolution, 50 kS/s, 2 analog outputs, and 16 digital I/O (includes eight high-current lines). Includes USB cable and MCC DAQ software CD.
USB-1208FS-Plus-OEM	Board-only USB-based DAQ device with eight analog inputs, 50 kS/s, up to 12-bit resolution, 50 kS/s, two analog outputs, 16 digital I/O lines (includes eight high-current lines).
USB-1408FS	USB-based DAQ device with 8 analog inputs, up to 14-bit resolution, 48 kS/s, 2 analog outputs, and 16 digital I/O. Includes USB cable and MCC DAQ software CD.
USB-1408FS-Plus	USB-based multifunction DAQ device with 8 SE/4 DIFF analog inputs, up to 14-bit resolution, 48 kS/s, 2 analog outputs, and 16 digital I/O (includes eight high-current lines). Includes USB cable and MCC DAQ software CD.
USB-1408FS-Plus-OEM	Board-only USB-based multifunction DAQ board with 8 SE/4 DIFF analog inputs, up to 14-bit resolution, 48 kS/s, 2 analog outputs, and 16 digital I/O (includes eight high-current lines).

Software also Available from MCC

DAQami	Easy-to-use advanced data logging software to acquire, view, and log data
TracerDAQ Pro	Out-of-the-box virtual instrument suite with strip chart, oscilloscope, function generator, and rate generator – professional version
DASYLab	Icon-based data acquisition, graphics, control, and analysis software

‡ Self-powered USB hubs and hosts have their own power supply. The USB port(s) on your computer are root port hubs. All externally powered root port hubs (desktop computers) provide up to 500 mA of current for a USB device. Battery-powered root port hubs provide 100 mA or 500 mA, depending upon the manufacturer. A laptop PC that is not connected to an external power adapter is an example of a battery-powered root port hub.

Bus-powered USB hubs and hosts do not have their own power supply.



Artisan Technology Group is your source for quality new and certified-used/pre-owned equipment

- FAST SHIPPING AND DELIVERY
- TENS OF THOUSANDS OF IN-STOCK ITEMS
- EQUIPMENT DEMOS
- HUNDREDS OF MANUFACTURERS SUPPORTED
- LEASING/MONTHLY RENTALS
- ITAR CERTIFIED SECURE ASSET SOLUTIONS

SERVICE CENTER REPAIRS

Experienced engineers and technicians on staff at our full-service, in-house repair center

*InstraView*SM REMOTE INSPECTION

Remotely inspect equipment before purchasing with our interactive website at www.instraview.com ↗

WE BUY USED EQUIPMENT

Sell your excess, underutilized, and idle used equipment. We also offer credit for buy-backs and trade-ins. www.artisanng.com/WeBuyEquipment ↗

LOOKING FOR MORE INFORMATION?

Visit us on the web at www.artisanng.com ↗ for more information on price quotations, drivers, technical specifications, manuals, and documentation

Contact us: (888) 88-SOURCE | sales@artisanng.com | www.artisanng.com