

VAMP-XGA3

Revision D

User Guide

**Copyright January 1999
Computer Dynamics, Inc.**

**7640 Pelham Road
Greenville, SC 29615
803-627-8800**

ECO History:

<u>ECO</u>	<u>Date</u>	<u>Description</u>
TBD		Initial Release
00904	6/22/00	Update Warranty

FCC Testing

This subassembly is marketed to be sold to equipment manufacturers for incorporation into systems. As such this equipment is not FCC tested. FCC testing is the responsibility of the final equipment manufacturer.

Table of Contents

1	INTRODUCTION	1
1.1	Description.....	1
1.2	VAMP-XGA3 Power Supply Requirements.....	1
1.2.1	12 Volt only board input.....	2
1.2.2	Individual board power regulator requirements.....	2
1.3	Board Layout	3
1.3.1	Board I/O Connections.....	3
2	HARDWARE CONFIGURATION	4
2.1	Video Interface (J8).....	5
2.2	Flat Panel Interface (J3)	6
2.3	Backlight Power Interface (J1).....	6
2.4	Control Interface	7
2.4.1	Serial Interface (J9 and J10).....	7
2.4.2	OSD Switch Interface (J11).....	8
2.5	Power Connector (J4).....	8
2.6	Auxiliary Power Interface (J2 and J6).....	9
2.7	LED Indicators.....	9
3	OSD MENU	10
3.1	User Interface Overview	10
3.2	Power On Default Settings.....	10
3.3	Display Control Menus.....	11
	Remove OSD	11
	Video Position Adj.	11
	Width	12
	Brightness	12
	Contrast.....	13
	Phase.....	13
	Zoom Enable	13
	Restore Factory Settings.....	13
	Video Source	14
	Menu Position Adj.	14
	Menu Timeout.....	15
	Status.....	15
4	INPUT SPECIFICATIONS	16
4.1	RGB Input Signals.....	16
4.2	Video Inputs.....	16
4.2.1	Video Input Signals.....	16
4.2.2	Video Input Formats	16
5	LVDS OUTPUT	17
5.1	LVDS Output Signals.....	17
	APPENDIX	18

List of Figures

Figure 1-1.	VAMP-XGA3 Block Diagram.....	1
Figure 1-2.	VAMP-XGA3 Basic Layout and Connectors	3
Figure 2-1.	Horizontal Connectors and Strapping Fields.	4
Figure 2-2.	Vertical Connectors and Strapping Fields.	4
Figure 2-3.	Single Row Connector and Strapping Field Pin Numbers.....	4
Figure 2-4.	Double Row Connector and Strapping Field Pin Numbers.	5
Figure 3-1.	External Switch Box Layout	10

Figure 3-3. PC Graphics Display Control Menu	11
Figure 3-4. Video Display Control Menu.....	12
Figure 3-5. Input Select Menu	14
Figure 3-6. PC Graphics Display Control Menu	15

List of Tables

Table 1 Input Supply Power.....	2
Table 2 Input Supply by Voltage.....	2
Table 3 Video Connections	5
Table 4 TTL Panel Connections	6
Table 5 Backlight Connections	6
Table 6 Serial Interface Connections	7
Table 7 OSM Switch Connections	8
Table 8 Input Power Connections.....	8
Table 9 Auxillary Power Output	9
Table 10 : RGB Input Signal Description.....	16
Table 11 : Composite Video Input	16
Table 12 : Video Input Formats.....	16
Table 13 : LVDS Signal Description.....	17

1 Introduction

1.1 Description

The VAMP-XGA3 is a standalone, LCD-based multi-sync video digitizer for LCD-based applications. The VAMP-XGA3 incorporates the components necessary to digitize analog RGB, VGA, SVGA and XGA, as well as SOG, NTSC and Composite video input signals. Video processing includes input video digitizing and frame rate conversions, video scaling from low resolution inputs to higher resolution LCD panels, and output timing and control to maintain a set output frame rate required by the LCD target panel.

An on-board micro-controller functions as the main system controller, responsible for system initialization, On Screen Display (OSD) user interface, input mode auto-detection, and other housekeeping functions.

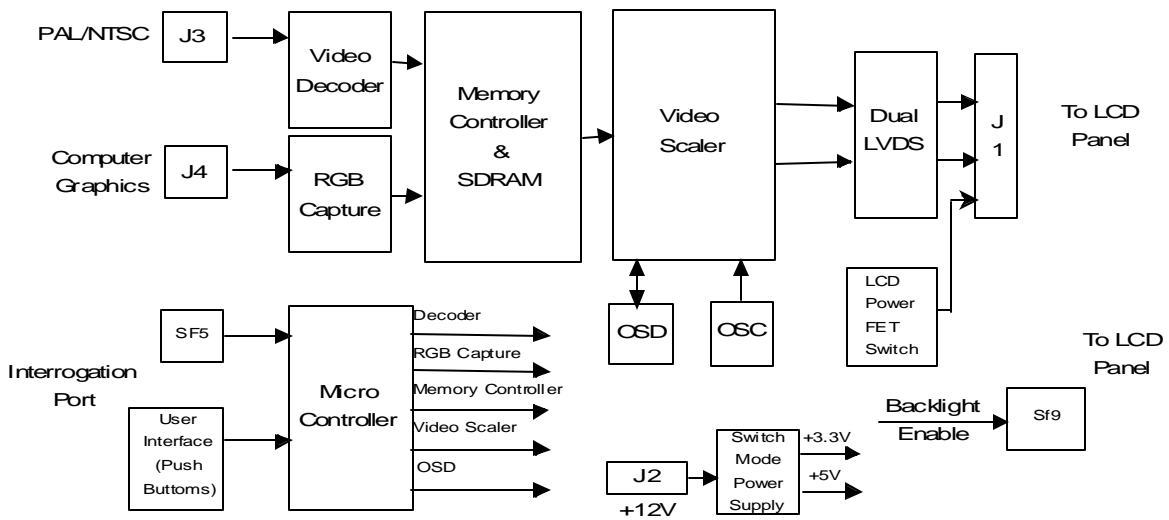

Figure 1-1. VAMP-XGA3 Block Diagram

- Accepts analog RGB inputs up to 1024 x 768 at 85Hz. Refer to Table 10 : RGB Input Signal Description
- Accepts NTSC and Sync-on-Green or Composite inputs.
- Supports Frame Rate Conversion for over 20 different input formats.
- Drives 1024x768 LCD panels at 60 Hz frame rates via an LVDS interface. (The LCD backlight is controlled via a separate connector.)
- Remote keypad connector allows the user to sequence through on-screen menus, allowing adjustments to the system.

1.2 VAMP-XGA3 Power Supply Requirements

An SH34 panel was used for these measurements. The total power of 18.5W (1.54A) should be considered the minimum requirement. If the board will be supplying power to other system devices the external power requirements plus margin should be added to this total.

1.2.1 12 Volt only board input

Table 1 Input Supply Power

Supply Voltage	Board with panel and backlight		Board Standalone		Note
	Power (W)	Current (A)	Power (W)	Current (A)	
12V	18.5	1.54	9.8	0.815	1

1.2.2 Individual board power regulator requirements

Table 2 Input Supply by Voltage

Supply Voltage	Board with panel and backlight		Board Standalone		Note
	Power (W)	Current (A)	Power (W)	Current (A)	
5V	4.1	0.82	1.8	0.36	2,4
3.3V	2.8	0.85	2.8	0.85	2
5VADC	1.8	0.15	1.8	0.15	3

Note:

- 1- Board input voltage adjusted to 12.00V.
- 2- Individual switching voltage regulators using 12 volt input.
- 3- The 5 volt ADC supply is a linear regulator. This current is included in the 12 volt requirement.
- 4- To reduce 12 volt power requirements, a board build option allows the 5 volt to be supplied by an external power supply.

1.3 Board Layout

Figure 1-2. VAMP-XGA3 Basic Layout and Connectors below illustrates the basic VAMP-XGA3 board layout and locates the input, output, and power supply connectors.

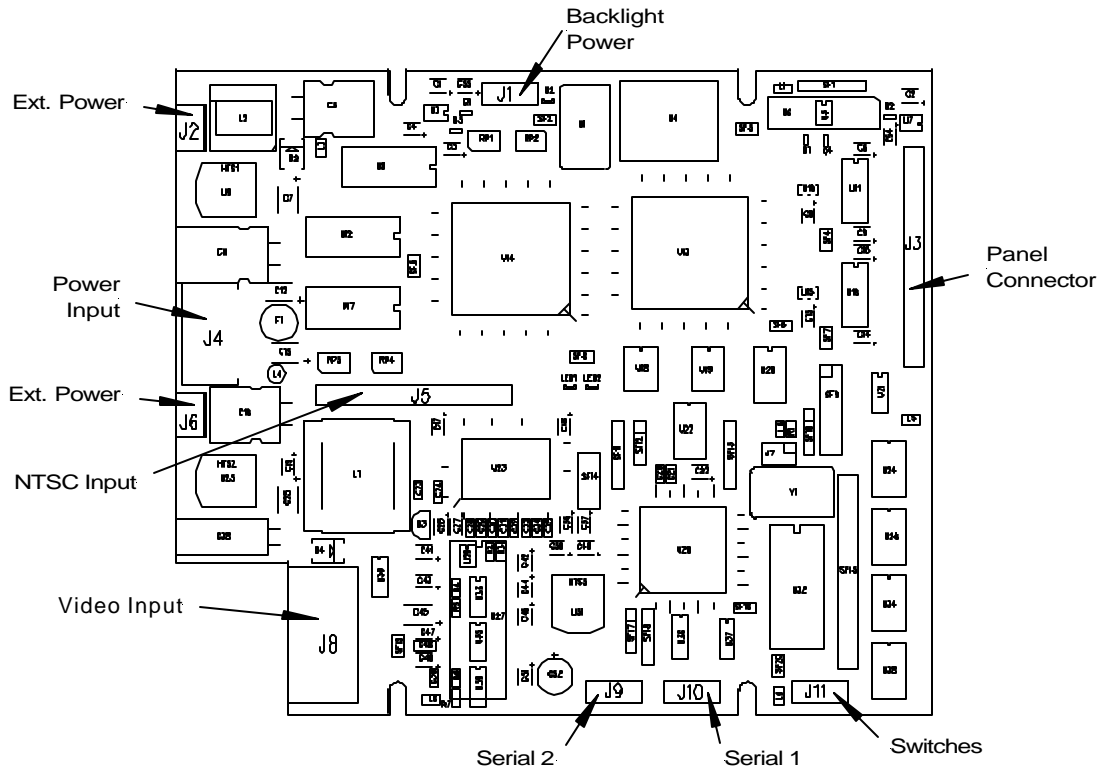

Figure 1-2. VAMP-XGA3 Basic Layout and Connectors

1.3.1 Board I/O Connections

Video Input:	◆ NTSC (J5) or Composite (J8)
Analog RGB Input:	◆ 15-Pin RGB or SOG Connector (J8)
LVDS LCD Output:	◆ 50-Pin (25x2 header) (J3)
LCD Back Light:	◆ 5x2 header (J1)
User Interface Port:	◆ 5x2 header connector (J11)
Power Input:	◆ Molex 4-pin (J4)

2 Hardware Configuration

All connector and strapping field orientations in this manual are relative to the board orientation as pictured in Figure 1-2. VAMP-XGA3 Basic Layout and Connectors.

Unless otherwise specified, horizontal double row connectors and single row strapping fields have pin 1 in the top right corner or to the right of the strapping field. Horizontal single row connectors have pin 1 to the left. All single row connectors are locking type.. Pin 1 always has a square pad. All other pins have round pads.

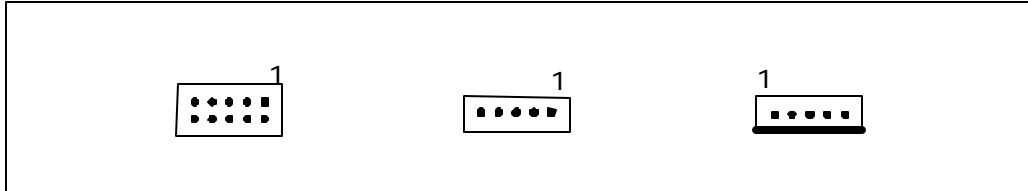

Figure 2-1. Horizontal Connectors and Strapping Fields.

Also if the connector is vertical, pin 1 is in the top left corner.

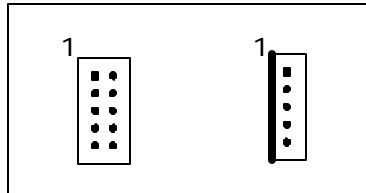

Figure 2-2. Vertical Connectors and Strapping Fields.

Single row connectors are numbered sequentially from top to bottom or one end to the other.

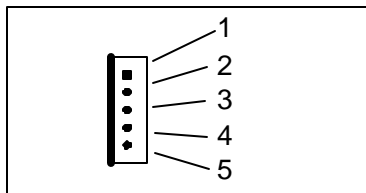

Figure 2-3. Single Row Connector and Strapping Field Pin Numbers.

Double row connectors are numbered with all even numbers on one side of the connector and all odd numbers on the other side.

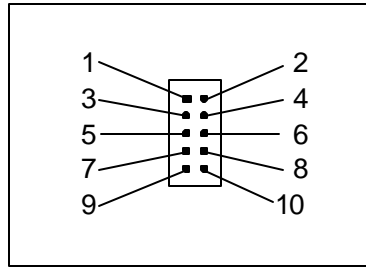

Figure 2-4. Double Row Connector and Strapping Field Pin Numbers.

2.1 Video Interface (J8)

Video inputs are supplied via a standard DB-15 connector using cable PN 2CAB9-1515-7300 CABLE,HD 15M-M, SHIELDED, 6', the pinouts are shown in the following table:

Table 3 Video Connections

VGA DB15	
1	RED
2	GREEN
3	BLUE
4	MONITOR ID BIT 2
5	SELF TEST (GND)
6	GND
7	GND
8	GND
9	NC
10	GND
11	MONITOR ID BIT 0
12	MONITOR ID BIT 1
13	H SYNC
14	V SYNC
15	MONITOR ID BIT 3

Pin 1 of J8 is located in the top right corner of the connector. For reference, position the VAMP-XGA3 as shown in Figure 1-2. VAMP-XGA3 Basic Layout and Connectors.

2.2 Flat Panel Interface (J3)

Table 4 TTL Panel Connections

Signal	Pin	Pin	Signal
+5 Volts	1	2	+5 Volts
+3.3 Volts	3	4	+3.3 Volts
Switched +5 Volts	5	6	Switched +5 Volts
Ground	7	8	Ground
TX01	9	10	TX00
TX03	11	12	TX02
TX05	13	14	TX04
TX09	15	16	TX08
TX07	17	18	TX06
Ground	19	20	Ground
TXE0	21	22	TXE1
TXE2	23	24	TXE3
TXE4	25	26	TXE5
TXE8	27	28	TXE9
TXE6	29	30	TXE7
Ground	31	32	Ground
N/C	33	34	SCLK
PNL CONFIG0	35	36	PNL CONFIG1
PNL CONFIG2	37	38	PNL CONFIG3
PNL CONFIG4	39	40	PNL CONFIG5
PNL CONFIG6	41	42	PNL CONFIG7
PNL SELECT0	43	44	PNL SELECT1
PNL SELECT2	45	46	PNL SELECT3
PNL SELECT4	47	48	SDATA
Ground	49	50	Ground

Pin 1 of J3 is located in the top left corner of the connector.

2.3 Backlight Power Interface (J1)

The SH21, Sharp PN LQ12D011, backlight power is available via J1. J1 is a 5 x 2 header with 0.1" centers. The pinout is shown in the following table.

Table 5 Backlight Connections

Backlight Power	
1	Bklight On
2	Switched +3.3V
3	Switched +12V
4	Switched +5V
5, 6	+5V
7 - 10	GND

The Bklight On signal is a digital output that indicates the backlight status. Bklight On will go low when the backlight is turned off by the microprocessor. The backlight is turned off during low power operation.

2.4 Control Interface

The VAMP-XGA3 can be controlled by commands transmitted and received via an RS-232 channel or through the OSD switch interface.

2.4.1 Serial Interface (J9 and J10)

The serial interface connectors, J9 and J10, are 2 x 5 straight headers with 0.1" centers. J10 is the normal HOST PC interface. The pinout is shown in the following table:

Table 6 Serial Interface Connections

Serial Interface	
1	NC
2	NC
3	Transmit
4	NC
5	Receive
6	NC
7	NC
8	NC
9	GND
10	N/C

Pin 1 of the 2 x 5 header for both are located in the top right corner of the connector.

2.4.2 OSD Switch Interface (J11)

The OSD switch Interface, J11, is a 2 x 5 straight header with 0.1" centers. The six momentary pushbutton switches on the VAMP-XGA switch board control the OSD via this interface. The OSD switch interface pinout is shown in the following table:

Table 7 OSD Switch Connections

Switch Interface	
1	+5V
2	SW 1
3	SW 2
4	SW 3
5	SW 4
6	SW 5
7	SW 6
8	SW 7
9	SW 8
10	GND

Pin 1 of J11 is located in the top right corner of the connector.

2.5 Power Connector (J4)

Power for the VAMP-XGA is supplied via J4, a 4 x 1 friction-lock MOLEX header. The power interface is the same as our SBC product line. Power requirements are +5V @ 2.5A and +12V @ .75A maximum.

Table 8 Input Power Connections

Power Input	
1	+12V
2	N/C
3	GND
4	+5V

2.6 Auxiliary Power Interface (J2 and J6)

The auxiliary power connectors, J2 and J6, are straight 4x1 locking headers with 0.1" centers. They are used to supply power to other parts of the system. Do not connect power for the VAMP-XGA3 to J2 or J6. Both connectors have the same pinout as the DP-POW-DIS board. Connections are as shown in the following table:

Table 9 Auxillary Power Output

Aux Power	
1	+12V (OUT)
2	N/C
3	GND
4	+5V (OUT)

2.7 LED Indicators

PWR LED "on" steady, indicates that power is good and the VAMP-XGA3 is functioning normally. PWR LED blinking rapidly indicates that a fatal error has occurred. PWR may blink slowly during power up and video mode changes. This is normal.

The VIDEO LED is a video sync indicator. If syncs are detected when an active video source or PC Graphics source is connected, the VIDEO LED will be on. A blue screen should appear on the display when the VAMP-XGA3 is powered up and syncs are not detected (VIDEO LED is OFF).

3 OSD Menu

3.1 User Interface Overview

An external switch box interface (J11) to the micro-controller accepts user selections in response to OSD Input Selection and Display Control menu options. The external switch box layout is shown in Figure 3-1. External Switch Box Layout, below. On-board firmware monitors switch activity and responds accordingly. The OSD menus provide the user with visual confirmation of selections and adjustments by highlighting selections and modifying on-screen bar-graph levels.

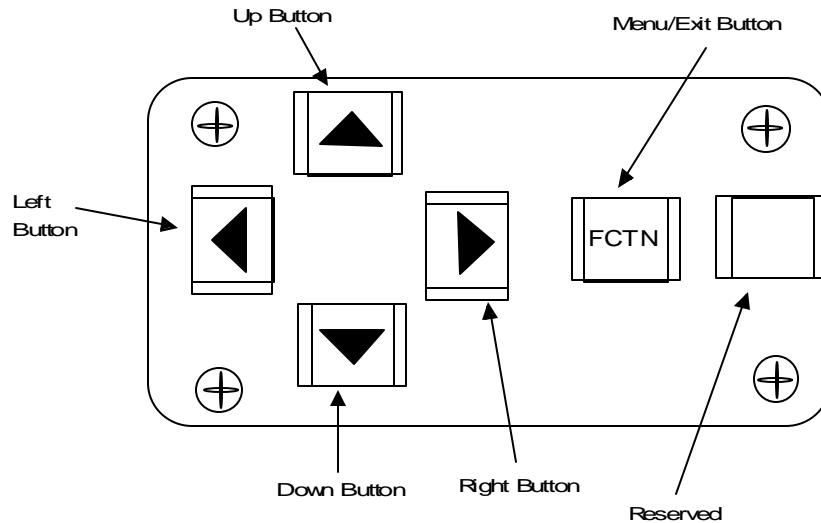

Figure 3-1. External Switch Box Layout







The switch box buttons provide the following selection functions:

FCTN	(activate Input Select Menu, exit all menus)
LEFT	(decrease selected parameter value)
RIGHT	(increase selected parameter value)
UP	(positioning Display image)
DOWN	(positioning Display image)

3.2 Power On Default Settings

The VAMP-XGA3 is initialized during power-on to the last known saved conditions. All parameters are saved whenever the user exits the menus, or by a sixty second time out.

3.3 Display Control Menus

The PC Graphics Display Control menu appears when the  key is pressed with the VAMP-XGA3 properly connected and powered up. The 'LEFT'  and 'RIGHT'  keys highlight the desired parameter and adjust the parameter value. The  and  keys are used to move between the upper and lower row of icons on the display. The displayed bar graph indicates the relative level for each parameter. To exit the Display Control menu, press the  key.

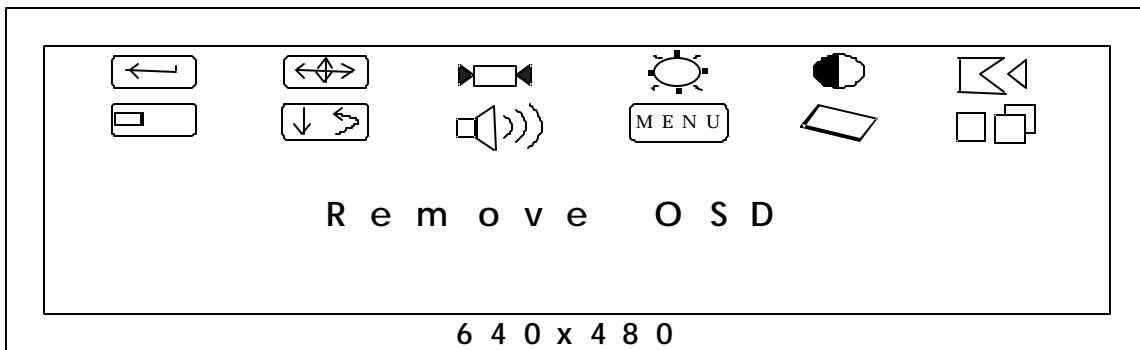





Figure 3-2. PC Graphics Display Control Menu



Not making a selection or adjustment within sixty seconds of activating the Display Control menu will result in the system exiting from the menu.





3.4.1 Remove OSD

This menu selection allows the manual removal of the On Screen Display from the Panel.



Press the  or  keys on the keypad to select the icon, then press  to begin this command.



3.4.2 Video Position Adj.

This menu selection allows the adjustment of the picture on the Panel. Press the  or  keys on the keypad to select the icon, then press  to begin this command.

The  or  keys are used to center the image horizontally on the display by moving the input image capture window left or right. The  and  keys are used to center the image vertically on the display by moving the input image capture window up or down. The image window may be moved anywhere in the input frame except within the V-sync period.

3.4.3 Width

This menu selection allows the adjustment of the horizontal width of the picture on the Panel. Press the  or  keys on the keypad to select the icon, then press  to begin this command.

The  or  keys are used to adjust the display image to fill the panel horizontally. A scroll bar will appear on the display to indicate the relative setting.

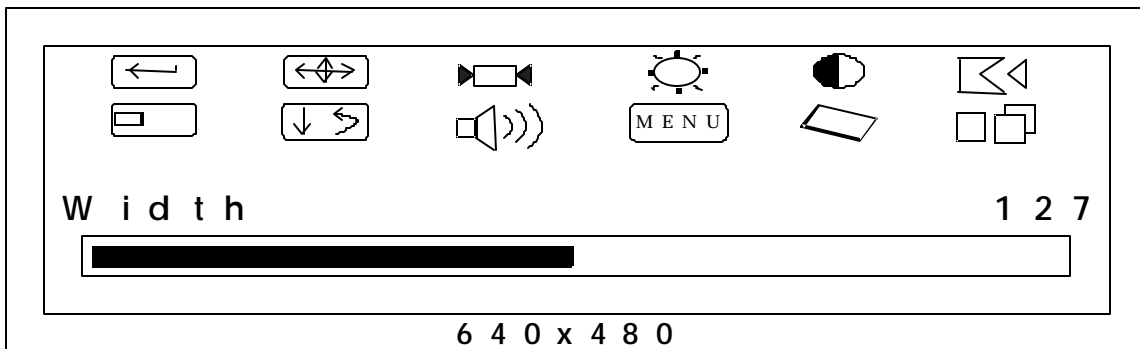







Figure 3-3. Video Display Control Menu



3.4.4 Brightness



The Brightness control adjusts the brightness level of the input source. Press the  or  arrow keys on the keypad to select the icon, then press  to begin this command.

The  or  keys are used to adjust the display image to the viewing preference of the user. A scroll bar will appear on the display to indicate the relative setting.



3.4.5 Contrast



The Contrast control adjusts the contrast ratio of the input source +/-3dB from the nominal 0.714V. Press the  or  keys on the keypad to select the icon, then press  to begin this command.



The  or  keys are used to adjust the display image to the viewing preference of the user. A scroll bar will appear on the display to indicate the relative setting.



3.4.6 Phase

The ADC Clock Phase adjustment is available for PC Graphics inputs only. Phase adjust alters the sub-pixel sampling (fine pixel adjust). The phase of the ADC sample pixel clock may be adjusted from 0 to 360 degrees for PC Graphics inputs.

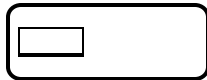

Press the  or  keys on the keypad to select the icon, then press  to begin this command.

The  or  keys are used to adjust the display for the clearest image. A poor adjustment is indicated by horizontal streaks on a 50% grey background. There may be several levels where no change is noticeable. Leave the adjustment in the center of this stable region. A scroll bar will appear on the display to indicate the relative setting.





3.4.7 Zoom Enable

This function toggles the Zoom feature of the VAMP. With Zoom disabled, a video resolution lower than the maximum the panel supports, will fill only a portion of the whole screen. With Zoom enabled, the VAMP XGA3 will stretch the lower video resolution image to fill the

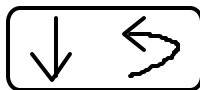
display screen. Press the  or  keys on the keypad to select the icon, then press  to toggle this feature.





3.4.8 Restore Factory Settings

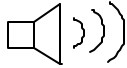

Press the  or  keys on the keypad to select the icon, then press  to select this feature. This will reset all Display Control menu parameters to their FACTORY DEFAULT settings.

3.4.9





Video Source

Press the  or  keys on the keypad to select the icon, then press  to select this feature. The Input Select Menu will appear when the VAMP-XGA3 is properly connected and powered up.

The  or  keys select which input will be displayed if multiple inputs are connected. The selections are: RGB (PC Graphics), YUV (Composite Video), or manual. Only

when manual is selected, the  key is used to select the Video Source menu, which will select one input type and will not provide an automatic switching for multiple sources. The

 or  keys select the desired input: RGB or YUV. Exit the menu by pressing  key again. Not making a selection within sixty seconds of activating the menu will result in the system exiting from the menu. A change in resolution of the selected input source will be detected within one second of obtaining valid source timing.

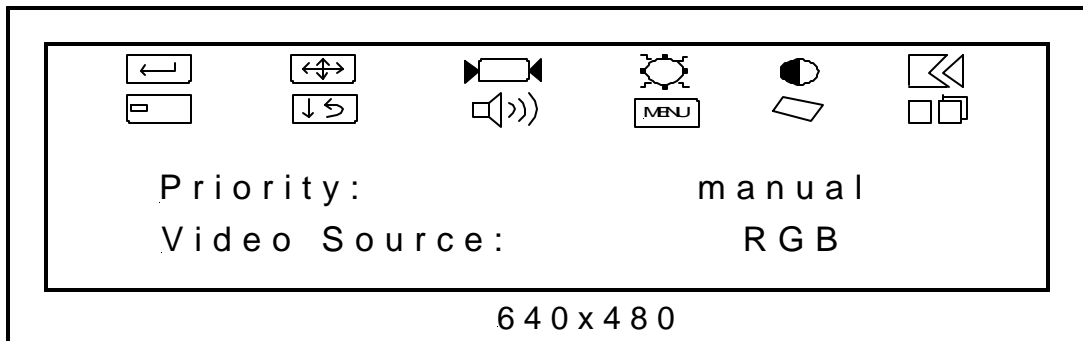









Figure 3-4. Input Select Menu

3.4.10





Menu Position Adj.



Press the  or  keys on the keypad to select the icon, then press  to select this feature.

The  or  keys are used to move the OSD horizontally on the display. The  and  keys are used to move the image vertically on the display.

3.4.11

Menu Timeout



Menu Timeout allows adjustment of the length of time the menu will be displayed before it is automatically removed from the display. Press the  or  keys on the keypad to select the icon, then press  to select this feature.

The  or  keys are used to decrease or increase the length of time the OSD is displayed. A scroll bar will appear on the display to indicate the relative setting.

3.4.12

Status

The Status display includes the Resolution, Refresh Frequency and Number of Lines displayed.

Press the  or  keys on the keypad to select the icon, then press  to select this display.

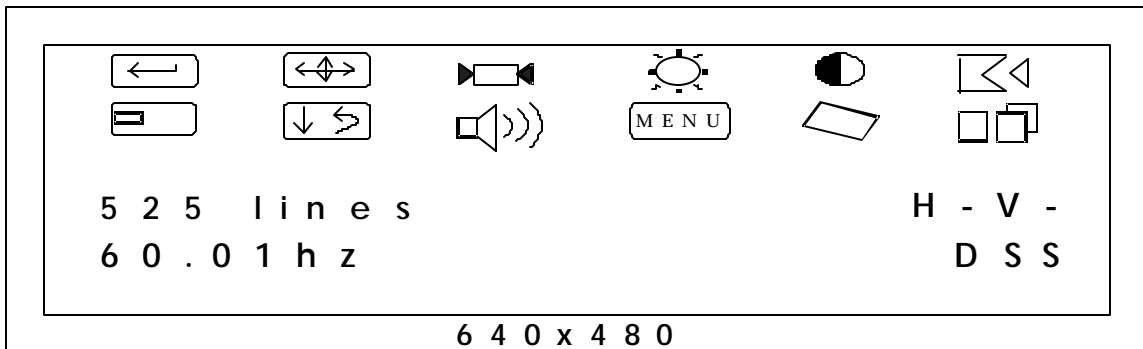

Figure 3-5. PC Graphics Display Control Menu

4 Input Specifications

4.1 RGB Input Signals

The RGB input connector (J8) is an HD15 female socket accepting analog RGB - 0.7 Vpp @ 75 ohms, TTL Levels for Horizontal & Vertical Sync.

Table 10 : RGB Input Signal Description

Pin #	Pin Name	Logic	I/O	Functional Description
1	RED	Analog	I	Computer Graphics
2	GRN	Analog	I	Computer Graphics
3	BLU	Analog	I	Computer Graphics
13	HSYNC	TTL	I	Horizontal Sync
14	VSYNC	TTL	I	Vertical Sync
5, 6, 7, 8, 10	GRND	GND		Ground
4, 9, 11, 12, 15	No Connect			Not Used

4.2 Video Inputs

4.2.1 Video Input Signals

Table 11 : Composite Video Input

Signal Type:	Composite Video
Signal Level:	1.0Vpp
Termination:	75Ω

4.2.2 Video Input Formats

Table 12 : Video Input Formats

Mode	Resolution	Horz. Freq. (KHz)	Vert. Freq. (Hz) Interlaced
NTSC Square Pixel	640x480	15.734	59.94
PAL Square Pixel	768x576	15.625	50

5 LVDS Output

5.1 LVDS Output Signals

The LCD panel interface is driven by a LVDS, high density, HDB 26 pin connector at J3. This connector also supplies 3.3V, 5V and 12V power supply outputs for panel and/or backlight power supply requirements.

Table 13 : LVDS Signal Description

Signal	Pin #	Logic Level	I/O	Functional Description
TX0-O	1	LVDS	O	Positive LVDS differential data output, Channel Zero , Odd Data
TX0+O	2	LVDS	O	Negative LVDS differential data output, Channel Zero, Odd Data
TX1-O	3	LVDS	O	Positive LVDS differential data output, Channel One, Odd Data
TX1+O	4	LVDS	O	Negative LVDS differential data output, Channel One, Odd Data
TX2-O	5	LVDS	O	Positive LVDS differential data output, Channel Two, Odd Data
TX2+O	6	LVDS	O	Negative LVDS differential data output, Channel Two, Odd Data
TXCK-O	7	LVDS	O	Negative LVDS differential clock output for odd data.
TXCK+O	8	LVDS	O	Positive LVDS differential clock output for odd data.
TX3-O	9	LVDS	O	Positive LVDS differential data output, Channel Three, Odd Data
TX3+O	18	LVDS	O	Negative LVDS differential data output, Channel Three, Odd Data
TX0-E	10	LVDS	O	Positive LVDS differential data output, Channel Zero, Even Data
TX0+E	11	LVDS	O	Negative LVDS differential data output, Channel Zero, Even Data
TX1-E	12	LVDS	O	Positive LVDS differential data output, Channel One, Even Data
TX1+E	13	LVDS	O	Negative LVDS differential data output, Channel One, Even Data
TX2-E	14	LVDS	O	Positive LVDS differential data output, Channel Two, Even Data
TX2+E	15	LVDS	O	Negative LVDS differential data output, Channel Two, Even Data
TXCK-E	16	LVDS	O	Negative LVDS differential clock output for Even data.
TXCK+E	17	LVDS	O	Positive LVDS differential clock output for Even data.
TX3-E	25	LVDS	O	Positive LVDS differential data output, Channel Three, Even Data
TX3+E	26	LVDS	O	Negative LVDS differential data output, Channel Three, Even Data
GND	19,2 2	GND		Ground
S+3.3v	20	Power	O	Switched +3.3v for Panel Drivers
S+12v	24	Power	O	Switched +12v for Panel Drivers
SVCC	21,2 3	Power	O	Switched +5v for Panel Drivers

APPENDIX

MECHANICAL OUTLINE

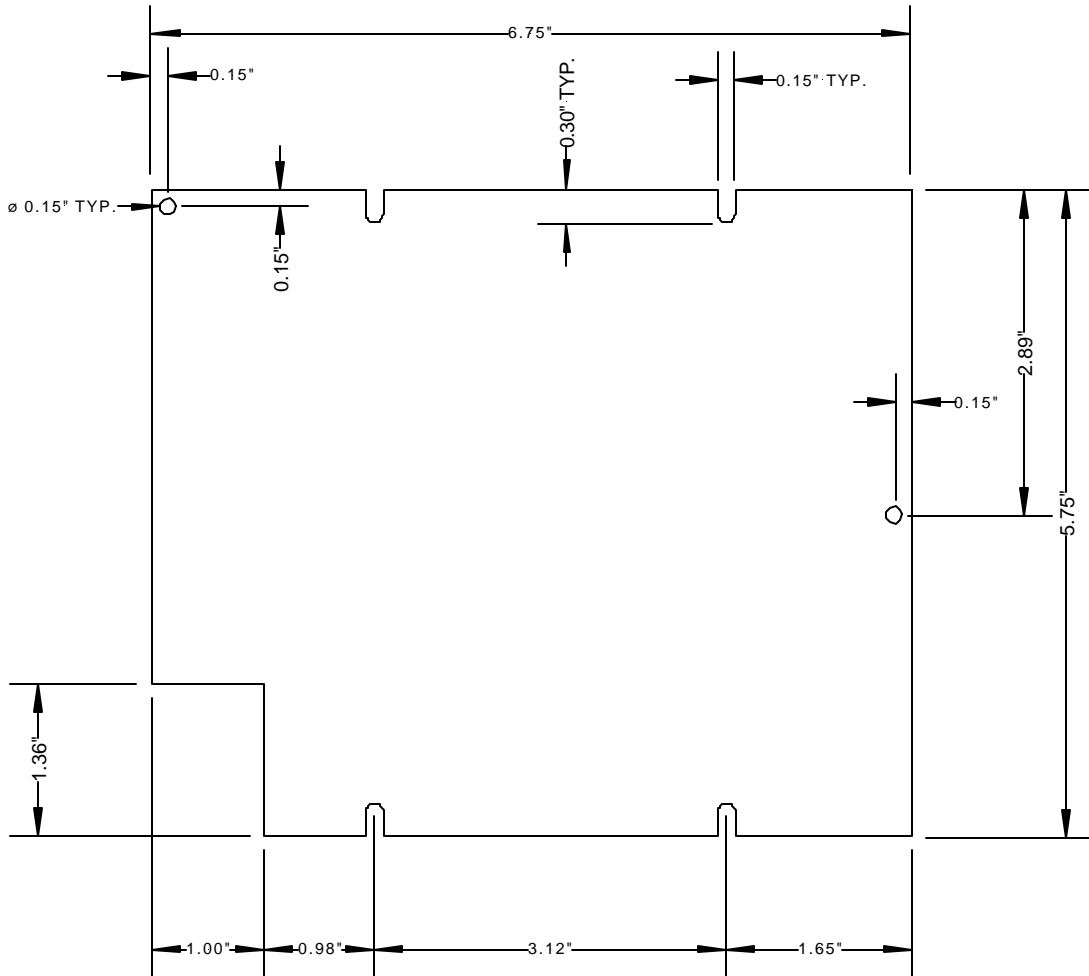



COMPUTER DYNAMICS INCORPORATED
7640 Pelham Rd., Greenville, SC 29615
Phone: (864) 627-8800

WARRANTY

CDI products are warranted for a period of one year from the date of purchase against all defects in materials and workmanship provided they are properly used and not modified by non-CDI personnel. Subassemblies and items not manufactured by CDI (power supplies, disk drives, etc.) are warranted for the period established by their original manufacturer. CDI will repair or replace the product, provided that it is returned promptly to CDI at the owner's expense. Prior to returning a component or subsystem, the purchaser must obtain a Return Material Authorization number (RMA#) from CDI. All board level products are shipped in an antistatic bag to prevent damage to the electronic components due to electrostatic discharge. Failure to use the bag in shipment will VOID the warranty. No other warranty is expressed or implied.

DISCLAIMER

CDI makes no representation or warranties with respect to the contents hereof and specifically disclaims any implied warranties of merchantability or fitness for any particular purpose. Further, CDI reserves the right to revise the prices or specifications and to make any changes from time to time in the contents hereof without obligation of CDI to notify any person of such revisions or changes.

To Our Customers:

It is our intention to provide you with accurate and useful information about our product. Although the information is correct to the best of our knowledge, we cannot assume responsibility for inaccuracies within the manual.

We request that you inform us of any errors found, areas difficult to understand or suggestions to improve this manual. Please fill out the bottom portion (using additional sheets if necessary) with your comments and return it to CDI.

Thank you.

Name: _____

Computer Dynamics, Inc.
7640 Pelham Rd.
Greenville, S.C. 29615
Phone: (864) 627-8800

Company: _____

Address:

Phone: _____

Product Type: _____

Card Serial No.

COMMENTS: