



## Artisan Technology Group is your source for quality new and certified-used/pre-owned equipment

- FAST SHIPPING AND DELIVERY
- TENS OF THOUSANDS OF IN-STOCK ITEMS
- EQUIPMENT DEMOS
- HUNDREDS OF MANUFACTURERS SUPPORTED
- LEASING/MONTHLY RENTALS
- ITAR CERTIFIED SECURE ASSET SOLUTIONS

### SERVICE CENTER REPAIRS

Experienced engineers and technicians on staff at our full-service, in-house repair center

### *InstraView*<sup>SM</sup> REMOTE INSPECTION

Remotely inspect equipment before purchasing with our interactive website at [www.instraview.com](http://www.instraview.com) ↗

### WE BUY USED EQUIPMENT

Sell your excess, underutilized, and idle used equipment. We also offer credit for buy-backs and trade-ins. [www.artisanng.com/WeBuyEquipment](http://www.artisanng.com/WeBuyEquipment) ↗

### LOOKING FOR MORE INFORMATION?

Visit us on the web at [www.artisanng.com](http://www.artisanng.com) ↗ for more information on price quotations, drivers, technical specifications, manuals, and documentation

**Contact us:** (888) 88-SOURCE | [sales@artisanng.com](mailto:sales@artisanng.com) | [www.artisanng.com](http://www.artisanng.com)

*The Embedded I/O Company*



---

# TVME210

## 2 Slot IndustryPack® VMEbus Carrier

Version 1.1

### User Manual

Issue 1.4

September 2006

---

**TEWS TECHNOLOGIES GmbH**

Am Bahnhof 7  
25469 Halstenbek, Germany  
[www.tews.com](http://www.tews.com)

Phone: +49-(0)4101-4058-0  
Fax: +49-(0)4101-4058-19  
e-mail: [info@tews.com](mailto:info@tews.com)

**TEWS TECHNOLOGIES LLC**

9190 Double Diamond Parkway,  
Suite 127, Reno, NV 89521, USA  
[www.tews.com](http://www.tews.com)

Phone: +1 (775) 850 5830  
Fax: +1 (775) 201 0347  
e-mail: [usasales@tews.com](mailto:usasales@tews.com)

---

## **TVME210-10**

2 Slot IndustryPack VMEbus Carrier, 3U front panel

## **TVME210-11**

2 Slot IndustryPack VMEbus Carrier, 6U front panel

This document contains information, which is proprietary to TEWS TECHNOLOGIES GmbH. Any reproduction without written permission is forbidden.

TEWS TECHNOLOGIES GmbH has made any effort to ensure that this manual is accurate and complete. However TEWS TECHNOLOGIES GmbH reserves the right to change the product described in this document at any time without notice.

TEWS TECHNOLOGIES GmbH is not liable for any damage arising out of the application or use of the device described herein.

Access terms are described as:

W Write Only

R Read Only

R/W Read/Write

R/C Read/Clear

R/S Read/Set

©2002-2006 by TEWS TECHNOLOGIES GmbH

IndustryPack is a registered trademark of SBS Technologies, Inc

---

<b>Issue</b>	<b>Description</b>	<b>Date</b>
1.0	First Issue	March 2002
1.1	Value correction chapter "VMEbus P1 connector"	October 2002
1.2	Function added to switch S3	September 2004
1.3	Clarification of Interrupt Mapping	November 2004
1.4	New address TEWS LLC	September 2006

---

# Table of Contents

<b>1</b>	<b>PRODUCT DESCRIPTION</b> .....	<b>6</b>
<b>2</b>	<b>TECHNICAL SPECIFICATION</b> .....	<b>7</b>
<b>3</b>	<b>CONFIGURATION</b> .....	<b>8</b>
	3.1 VME A16 Base Address.....	9
	3.2 Interrupts .....	11
	3.3 VME A24 Memory Enable and Size .....	12
	3.4 VME A24 Base Address.....	14
<b>4</b>	<b>IP IRQ AND CONTROL REGISTER</b> .....	<b>16</b>
	4.1 IP IRQ Configuration Register .....	16
	4.2 Control Register .....	17
<b>5</b>	<b>IP STROBE SIGNAL</b> .....	<b>18</b>
<b>6</b>	<b>INSTALLATION OF INDUSTRYPACKS</b> .....	<b>19</b>
<b>7</b>	<b>FRONT PANEL INDICATORS</b> .....	<b>20</b>
	7.1 ACK- and Power- LEDs.....	20
	7.2 Fuses and Filters.....	20
<b>8</b>	<b>PIN ASSIGNMENT</b> .....	<b>21</b>
	8.1 IP Connectors.....	21
	8.2 VMEbus P1 Connectors .....	22

---

# Table of Figures

FIGURE 1-1 : BLOCK DIAGRAM.....	6
FIGURE 2-1 : TECHNICAL SPECIFICATION.....	7
FIGURE 3-1 : ROTARY SWITCH S1 – S6.....	8
FIGURE 3-2 : CONFIGURATION STEPS.....	8
FIGURE 3-3 : VME A16 BASE ADDRESS .....	9
FIGURE 3-4 : VME A16 ADDRESS MAP (S3 = “0” TO “7”) .....	10
FIGURE 3-5 : VME A16 ADDRESS MAP (S3 = “8” TO “F”).....	10
FIGURE 3-6 : INTERRUPT MAPPING .....	11
FIGURE 3-7 : VME INTERRUPT MAPPING BY S3 .....	11
FIGURE 3-8 : VME A24 MEMORY ENABLE AND SIZE .....	12
FIGURE 3-9 : VME MEMORY SIZE BY S4 .....	13
FIGURE 3-10: VME A24 BASE ADDRESS .....	14
FIGURE 3-11: VME A24 ADDRESS MAP .....	15
FIGURE 4-1 : IP IRQ CONFIGURATION REGISTERS.....	16
FIGURE 4-2 : IP CONTROL REGISTERS.....	17
FIGURE 5-1 : IP STROBE SIGNAL .....	18
FIGURE 6-1 : FRONT PANEL.....	19
FIGURE 7-1 : IP ACK LED.....	20
FIGURE 7-2 : IP POWER LED.....	20
FIGURE 8-1 : IP J1 LOGIC INTERFACE PIN ASSIGNMENT .....	21
FIGURE 8-2 : VMEBUS P1 CONNECTOR.....	22

# 1 Product Description

The TVME210 is a non-intelligent VMEbus single slot, 3U form factor IndustryPack® Carrier for up to 2 single-sized IndustryPack (IP) modules or 1 double-sized IP module used to build modular, flexible and cost effective I/O solutions for applications in process control, medical systems, telecommunication and traffic control.

The TVME210 is designed in accordance to VMEbus Specification ANSI/VITA 1-1994 and the IndustryPack Logic Interface Specification ANSI/VITA 4-1995. It guarantees compatibility with the wide range of IndustryPacks in a VMEbus system.

IndustryPack I/O and ID spaces are mapped into the VME A16/D16 space.

Strobe signals of both IP modules are accessible via a 2 pin jumper block on the TVME210.

DMA, 32 bit access and 32 MHz operations are not supported.

Two 50 pin, 0.1 inch flat ribbon cable connectors mounted in the 3U (TVME210-10) or 6U (TVME210-11) front panel provide access to all IP I/O lines. Status indicators for IP access, +5V and +/-12V are provided.

A set of 16-position rotary switches allows easy configuration of VME Short I/O and Memory addresses. Interrupt routing from the IP slots to the VME IRQs can be done in two ways: programmable by software or selection of predefined sets by a rotary switch.

The IP power lines are fuse protected by self healing fuses and RF filtered. The operating temperature range is -40°C and +85°C.

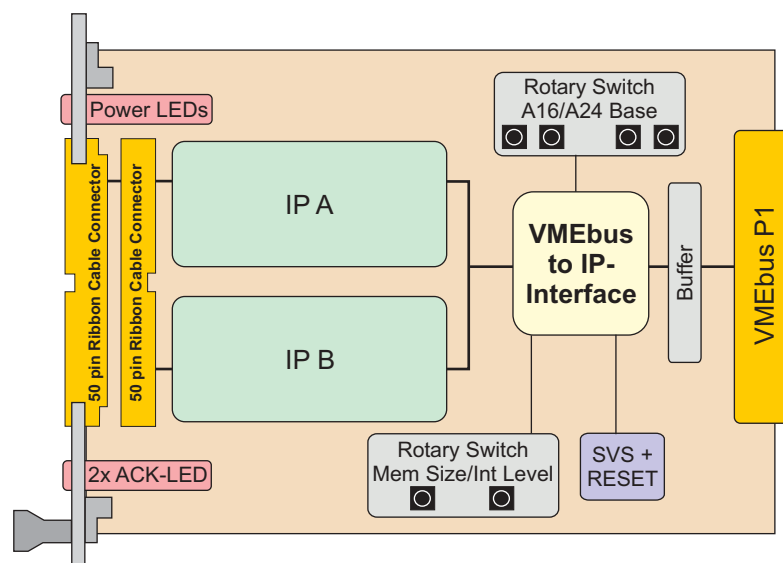

Figure 1-1 : Block Diagram

## 2 Technical Specification

<b>VMEbus Slave Interface</b>	According to VMEbus specification, ANSI / VITA 1-1994, 3U-Board	
<b>Short I/O</b>	VME A16, D08/16, Address Modifier: 29, 2D Size: 512 Bytes (256 Bytes / IP)	
<b>Memory</b>	VME A24, D08/16, Address Modifier: 39, 3A, 3D, 3E Size: programmable from 32 Kbytes to 8 Mbytes per IP	
<b>Interrupts</b>	VME IRQ1-7	
<b>IP Interface</b>	According to IndustryPack specification ANSI / VITA 4-1995	
<b>IP Slots</b>	Two single-size or one double-size with front panel I/O	
<b>Mapping of IP Interrupts to VMEbus</b>	Programmable by software or selection of predefined sets by a rotary switch	
<b>I/O Access</b>	50 pin 0.1 inch flat ribbon cable connector per IP, mounted in the front panel	
<b>DMA</b>	Not supported	
<b>32 MHz</b>	Not supported	
<b>Status LEDs</b>	ACK LED for each IP Slot +5V Power LED for each IP Slot +12V and -12V Power LED	
<b>Protection</b>	Self healing fuses and RF-filtering on all IP power lines	
<b>Power Requirements without IP Modules</b>	280 mA typical @ + 5V DC 1 mA typical @ + 12V DC 1 mA typical @ -12V DC <b>Additional Power is required by IP Modules</b>	
<b>Temperature Range</b>	Operating	- 40°C to + 85C
	Storage	- 40°C to + 125°C
<b>MTBF</b>	377000 hours	
<b>Weight</b>	150 g – no IndustryPack inserted	
<b>Size</b>	Single Size 3U Euro Card	
<b>Humidity</b>	5 – 95 % non-condensing	

Figure 2-1 : Technical Specification



# 3 Configuration

Setting 6 rotary switches allows all required configuration of the TVME210. Position of the switches is shown below:

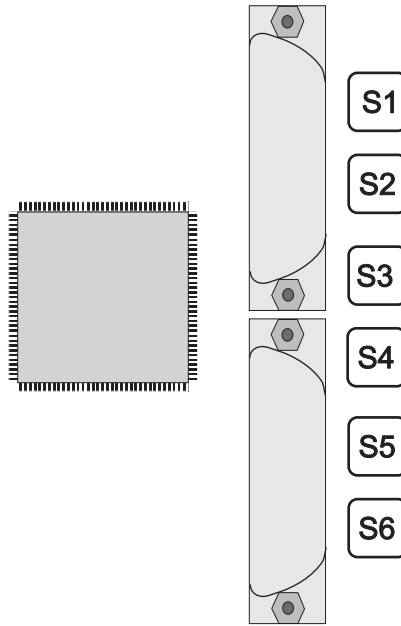

Figure 3-1 : Rotary Switch S1 – S6

Step	Rotary Switch	Function	Default Value
1	S1 / S2	VME A16 Base Address	0x6000
2	S3	Interrupt Mapping	VIPC310 compatible
3	S4	VME A24 Memory Enable and Memory Size	Disabled
4	S5 / S6	VME A24 Memory Base Address	A24: 0x600000

Figure 3-2 : Configuration Steps

## 3.1 VME A16 Base Address

The VME A16 Base Address of the TVME210 is set by rotary switch S1 and S2.

Rotary switch S1 sets A[15:12] of the VME A16 Base Address.

Rotary switch S2 sets A[11:09] of the VME A16 Base Address.

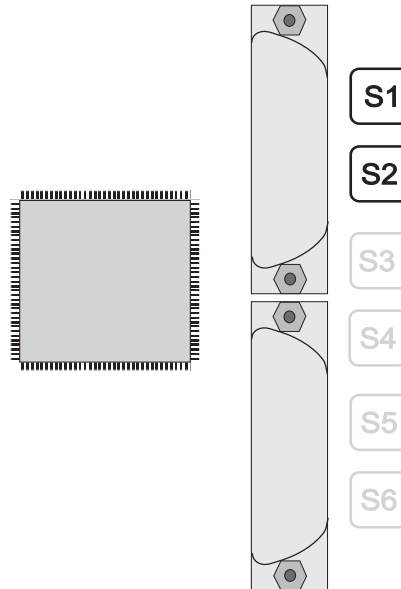
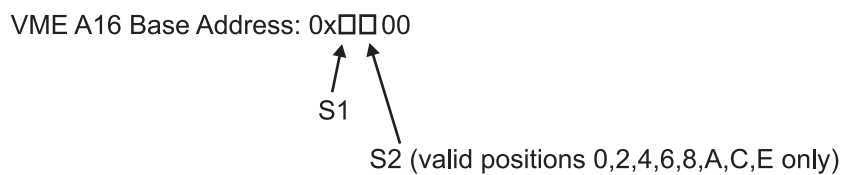

Figure 3-3 : VME A16 Base Address



The default value for the VME A16 Base Address is 0x6000 (S1=6, S2=0)

The TVME210 requires an address space of 512 bytes within the VME A16 address space. Each of the two IP slots occupies 256 bytes within this 512 bytes VME A16 address space.

The address space for each IP is divided into the following areas: IP I/O space, IP ID space and the IP IRQ and Control Register.

The IP I/O space has a size of 128 bytes. The size of the IP ID space and the IP IRQ and Control Register depends on the position of switch S3:

With S3 = "0" to "7", the IP IRQ and Control Registers of the TVME210 are accessible, and the size of the IP ID space is 64 bytes. The remaining 64 bytes are occupied by the IP IRQ and Control Registers. If switch S3 = "8" to "F", the IP IRQ and Control Registers of the TVME210 are not accessible, and the corresponding address range is added to the IP ID space, resulting in a size of 128 bytes for the IP ID space with S3 = "8" to "F". This configuration is necessary for IP modules that require access to the ID Space above the ID PROM.

See figures below for more details.

VME A16 Base Address	Description	Default
+ 0x0000	I/O Space IP A	0x6000
+ 0x0080	ID Space IP A	0x6080
+ 0x00C0	IRQ and Control Register IP A	0x60C0
+ 0x0100	I/O Space IP B	0x6100
+ 0x0180	ID Space IP B	0x6180
+ 0x01C0	IRQ and Control Register IP B	0x61C0

Figure 3-4 : VME A16 Address Map (S3 = "0" to "7")

VME A16 Base Address	Description	Default
+ 0x0000	I/O Space IP A	0x6000
+ 0x0080	ID Space IP A	0x6080
+ 0x0100	I/O Space IP B	0x6100
+ 0x0180	ID Space IP B	0x6180

Figure 3-5 : VME A16 Address Map (S3 = "8" to "F")

## 3.2 Interrupts

Each IndustryPack is able to generate interrupts on two interrupt request lines (INT0 and INT1). The VMEbus offers seven interrupt request levels. IRQ7 has the highest priority, IRQ1 has the lowest priority.

IP interrupt requests can be mapped to any of the 7 VME interrupt request levels. Interrupt routing from the IP slots to the VME IRQs can be done by selection of predefined sets with a rotary switch or programmable by software if S3 is in the range of "0" to "7".

For more information about fully programmable interrupt mapping please refer to chapter "IP IRQ and Control Register".

Rotary switch S3 can be used to select predefined sets of mapping of the four IP interrupt requests (two requests per IP slot) to the seven VME interrupt request levels. The mapping selected with S3 = "0" to "7" is mirrored at S3 = "8" to "F". The difference is that access to the IP IRQ and Control Registers of the TVME210 is only possible in switch position S3 = "0" to "7". See Chapter "IP IRQ and Control Register" and Chapter "VME A16 Base Address" for more details.

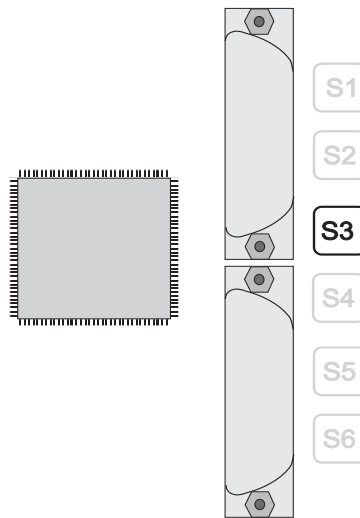

Figure 3-6 : Interrupt Mapping

S3 =	0	1	2	3	4	5...7	8*	9*	A*	B*	C*	D*...F*
IPA, Int0	-	1	4	6	1	reserved	-	1	4	6	1	reserved
IPA, Int1	-	2	5	4	1	reserved	-	2	5	4	1	reserved
IPB, Int0	-	3	2	3	2	reserved	-	3	2	3	2	reserved
IPB, Int1	-	4	1	1	2	reserved	-	4	1	1	2	reserved

"-" = No VME IRQ level mapped to IP INTx

\* no access to the IP IRQ and Control registers of the TVME210, see Chapter 4 and Chapter 3.1 for more details.

Figure 3-7 : VME Interrupt Mapping by S3

S3 = "2", "A" corresponds to the VME Interrupt Mapping of the VIPC310.

S3 = "3", "B" corresponds to the VME Interrupt Mapping of another version of the VIPC310.

The default value for S3 is "2".

### 3.3 VME A24 Memory Enable and Size

If VME memory space is not required, switch S4 to "0" (VME A24 memory disabled).

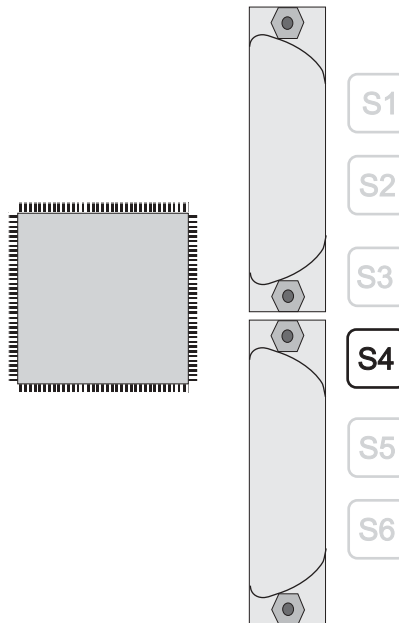

Figure 3-8 : VME A24 Memory Enable and Size

IndustryPack Memory is mapped into the VME A24 memory space. The memory size can be configured from 32 Kbytes to 4 Mbytes memory per IP slot, or up to 8 Mbytes for one IP.

Rotary switch S4 is used to enable/disable VME A24 memory and to select the required VME memory size. Default setting of S4 is "0", which signifies VME A24 memory is disabled.

Positions "1" to "E" of S4 represent several memory spaces in VME A24 address space.

With S4 = "1...8", the Memory Spaces for both IPs have the same size. If i.e. one IP requires 128 Kbytes of memory and the other IP requires 64 Kbytes of memory, then S4 must be set to "3", which selects a VME A24 memory size of 256 Kbytes, 128 Kbytes memory for each IP.

Value of S4:	VME Memory Size:		
0x0	VME A24 memory disabled		
0x1	A24	64 Kbytes	32 Kbytes / IP
0x2	A24	128 Kbytes	64 Kbytes / IP
0x3	A24	256 Kbytes	128 Kbytes / IP
0x4	A24	512 Kbytes	256 Kbytes / IP
0x5	A24	1 Mbytes	512 Kbytes / IP
0x6	A24	2 Mbytes	1 Mbytes / IP
0x7	A24	4 Mbytes	2 Mbytes / IP
0x8	A24	8 Mbytes	4 Mbytes / IP
0x9	A24	2 Mbytes	2 Mbytes for IP A
0xA	A24	4 Mbytes	4 Mbytes for IP A
0xB	A24	8 Mbytes	8 Mbytes for IP A
0xC	A24	2 Mbytes	2 Mbytes for IP B
0xD	A24	4 Mbytes	4 Mbytes for IP B
0xE	A24	8 Mbytes	8 Mbytes for IP B
0xF	reserved		

Figure 3-9 : VME Memory Size by S4

### 3.4 VME A24 Base Address

The memory space of IndustryPacks is mapped in the VME A24 space.

The memory base address for VME A24 is set with the switches S5 and S6.

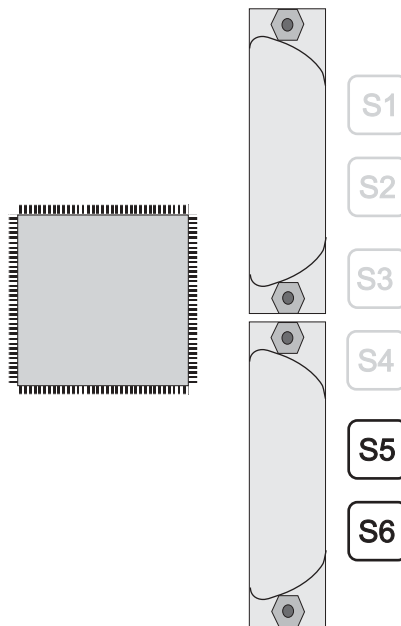

Figure 3-10: VME A24 Base Address

S5 represents A[23:20], and S6 represents A[19:16] of VME A24 memory space.

VME A24 Base Address: 0x□□0000  
                                  ↑  ↑  
                                  S5 S6

**The memory base address of the TVME210 must be set on a boundary equal to the VMEbus A24 memory size, as selected by S4! See figure below for details.**

The default value for VME A24 base address is 0x600000 (S5=6, S6=0).

TVME210 VME A24 Size		IP Memory Size	IP Slot	IP Memory Location: Mem. Base Address +	VMEbus Address Boundary
A24	64 Kbytes	32 Kbytes	A	0x000000	multiple of 0x010000
		32 Kbytes	B	0x008000	
A24	128 Kbytes	64 Kbytes	A	0x000000	multiple of 0x020000
		64 Kbytes	B	0x010000	
A24	256 Kbytes	128 Kbytes	A	0x000000	multiple of 0x040000
		128 Kbytes	B	0x020000	
A24	512 Kbytes	256 Kbytes	A	0x000000	multiple of 0x080000
		256 Kbytes	B	0x040000	
A24	1 Mbytes	512 Kbytes	A	0x000000	multiple of 0x100000
		512 Kbytes	B	0x080000	
A24	2 Mbytes	1 Mbytes	A	0x000000	multiple of 0x200000
		1 Mbytes	B	0x100000	
A24	4 Mbytes	2 Mbytes	A	0x000000	multiple of 0x400000
		2 Mbytes	B	0x200000	
A24	8 Mbytes	4 Mbytes	A	0x000000	multiple of 0x800000
		4 Mbytes	B	0x400000	
A24	2 Mbytes	2 Mbytes	A	0x000000	multiple of 0x200000
		-	B	-	
A24	4 Mbytes	4 Mbytes	A	0x000000	multiple of 0x400000
		-	B	-	
A24	8 Mbytes	8 Mbytes	A	0x000000	multiple of 0x800000
		-	B	-	
A24	2 Mbytes	-	A	-	multiple of 0x200000
		2 Mbytes	B	0x000000	
A24	4 Mbytes	-	A	-	multiple of 0x400000
		4 Mbytes	B	0x000000	
A24	8 Mbytes	-	A	-	multiple of 0x800000
		8 Mbytes	B	0x000000	

Figure 3-11: VME A24 Address Map



# 4 IP IRQ and Control Register

If switch S3 is in the range of “0” to “7”, the TVME210 provides a set of two registers for each IP: The IP IRQ Configuration Register and the IP Control Register.

Setting switch S3 to a value of “8” to “F” disables the IP IRQ Register and the IP Control Register. The address range of the IP IRQ and Control Register from “VME A16 Base Address” + “IP Offset” + 0xC0 to 0xFF is then mapped to the ID Space of the corresponding IP module, enlarging the ID Space of each IP module from 64 bytes to 128 bytes.

## 4.1 IP IRQ Configuration Register

Switch S3 must be in the range of “0” to “7” to access the IP IRQ Configuration Register. The register is divided in 2 equal parts, one for each interrupt. The bits [0, 4] are the LSBs, and the bits[2, 6] are the MSBs of the programmed IRQ level.

IPA IRQ Configuration Register			VME A16 Base Address + 0x00C1	
Bit	Symbol	Description	Access	Reset Value
7				
6	IPA, INT1	VME IRQ Level	R/W	Depends on S3 jumper setting
5		000 = interrupt is disabled	R/W	
4		[6:4] 001 to 111 = VMEbus IRQ-levels IRQ1 to IRQ7	R/W	
3			R/W	
2	IPA, INT0	VME IRQ Level	R/W	Depends on S3 jumper setting
1		000 = interrupt is disabled	R/W	
0		[2:0] 001 to 111 = VMEbus IRQ-levels IRQ1 to IRQ7	R/W	

IPB IRQ Configuration Register			VME A16 Base Address + 0x01C1	
Bit	Symbol	Description	Access	Reset Value
7				
6	IPB, INT1	VME IRQ Level	R/W	Depends on S3 jumper setting
5		000 = interrupt is disabled	R/W	
4		[6:4] 001 to 111 = VMEbus IRQ-levels IRQ1 to IRQ7	R/W	
3			R/W	
2	IPB, INT0	VME IRQ Level	R/W	Depends on S3 jumper setting
1		000 = interrupt is disabled	R/W	
0		[2:0] 001 to 111 = VMEbus IRQ-levels IRQ1 to IRQ7	R/W	

Figure 4-1 : IP IRQ Configuration Registers

## 4.2 Control Register

Both IP Control Registers are located in the VMEbus A16 space. Switch S3 must be in the range of “0” to “7” to access the IP Control Register.

IPA Control Register		VME A16 Base Address + 0x00C3		
Bit	Symbol	Description	Access	Reset Value
7	IP A, Reset	1 = reset is initiated Remains '1', until the IP reset has been completed and is then set to '0' by the on board logic. It can be read to verify the status of the reset.	R/W	0
6	reserved	Carry random information	R	undefined
5	reserved		R	undefined
4	reserved		R	undefined
3	reserved		R	undefined
2	IP A, Error	1 = error signal is active	R	0
1	IP A, INT1	Interrupt status	R	0
0	IP A, INT0	1 = indicates a pending interrupt request	R	0

IPB Control Register		VME A16 Base Address + 0x01C3		
Bit	Symbol	Description	Access	Reset Value
7	IP B, Reset	1 = reset is initiated Remains '1', until the IP reset has been completed and is then set to '0' by the on board logic. It can be read to verify the status of the reset.	R/W	0
6	reserved	Carry random information	R	undefined
5	reserved		R	undefined
4	reserved		R	undefined
3	reserved		R	undefined
2	IP B, Error	1 = error signal is active	R	0
1	IP B, INT1	Interrupt status	R	0
0	IP B, INT0	1 = indicates a pending interrupt request	R	0

Figure 4-2 : IP Control Registers

---

## 5 IP Strobe Signal

The IP strobe signal is an uncommitted line of the IP logic interface, which may be used as an optional input to or output from an IP module. It is reserved for a digital strobe or clock signal related to the functionality of the IP.

Strobe signals of both IP slots are accessible on the TVME210 via a 2 pin jumper field.

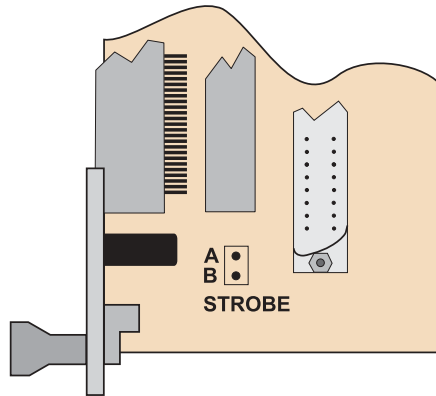

Figure 5-1 : IP Strobe Signal

## 6 Installation of IndustryPacks

Before installing an IndustryPack, be sure that the power supply for the TVME210 is turned off.

The component is an Electrostatic Sensitive Device (ESD). Use an anti-static mat connected to a wristband when handling or installing the components.

Installing IndustryPacks on the TVME210 is done by simply snapping them into one of the two IP slots. The connectors are keyed, so the IndustryPack can only be installed correctly.

After an IP has been installed it can be secured on the carrier board. This is normally necessary only in high vibration or shock environments.

Screws and spacers are required to fix a single IP on the TVME210. They can be ordered from TEWS TECHNOLOGIES GmbH (Part number: TIPxxx-HK).

All IPs mate with 50-pin flat cable receptacle connectors for their I/O. The front panel labeling indicates which connector is associated with the according IP slot. Pin 1 for each cable is identified by the mark on the connector or a square solder pad.

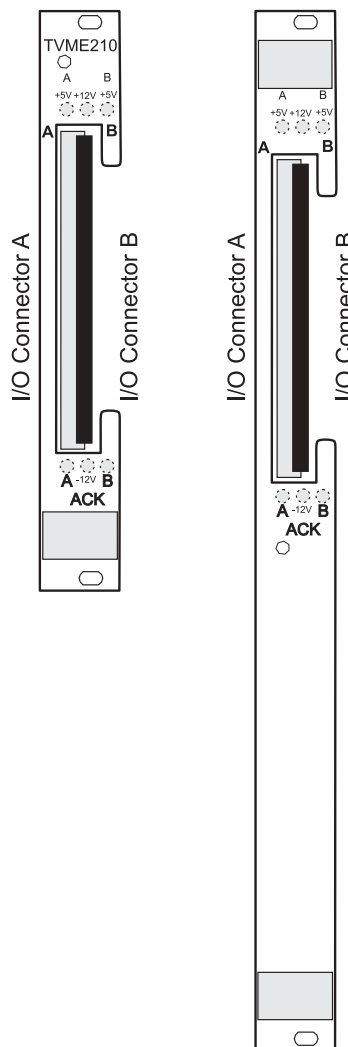

Figure 6-1 : Front Panel

---

# 7 Front Panel Indicators

## 7.1 ACK- and Power- LEDs

For a quick visual inspection the TVME210 offers 6 LEDs in the front panel.

Each IndustryPack has its own “ACK” LED, which is lit for about 200ms whenever an access to the corresponding IP happens.

Function	Label	Color	Description
IP A ACK	A	green	Indicates access to IP A
IP B ACK	B	green	Indicates access to IP B

Figure 7-1 : IP ACK LED

Additionally there are 4 green Power LEDs in the front panel of the TVME210:

Function	Label	Color	Description
IP A +5V	+5V A	green	LED = “on”: IP power supply ok
IP B +5V	+5V B	green	
+12V common to all IP	+12V	green	LED = “on”: +12V power ok
-12V common to all IP	-12V	green	LED = “on”: -12V power ok

Figure 7-2 : IP Power LED

## 7.2 Fuses and Filters

All IP slots are fuse protected. The fuses used on the TVME210 are self-healing fuses. For improved performance the TVME210 provides RF filtering and decoupling capacitors on all IP power lines.

---

# 8 Pin Assignment

## 8.1 IP Connectors

The table below shows the complete IP J1 logic interface pin assignments. Some of these signals are not used on the TVME210.

Pin #	Signal	Pin #	Signal	Pin #	Signal	Pin #	Signal
1	GND	2	CLK	26	GND	27	+5V
3	Reset#	4	D0	28	R/W#	29	IDSel#
5	D1	6	D2	30	DMAReq0#	31	MemSel#
7	D3	8	D4	32	DMAReq1#	33	IntSel#
9	D5	10	D6	34	DMAck#	35	IOSel#
11	D7	12	D8	36	Reserved	37	A1
13	D9	14	D10	38	DMAEnd#	39	A2
15	D11	16	D12	40	Error#	41	A3
17	D13	18	D14	42	IntReq0#	43	A4
19	D15	20	BS0#	44	IntReq1#	45	A5
21	BS1#	22	-12V	46	Strobe#	47	A6
23	+12V	24	+5V	48	ACK#	49	Reserved
25	GND			50	GND		

Figure 8-1 : IP J1 Logic Interface Pin Assignment

The IP J2 I/O connector routes the IP I/O lines directly to the appropriate pins of the 50 pin IP I/O ribbon cable connector. The pin assignment of the IP J2 I/O connector is IP specific.

## 8.2 VMEbus P1 Connectors

Pin	Row A	Row B	Row C
1	VME_D0	VME_BBSY#	VME_D8
2	VME_D1	VME_BCLR#	VME_D9
3	VME_D2	VME_ACFAIL#	VME_D10
4	VME_D3	VME_BGIN0#	VME_D11
5	VME_D4	VME_BGOUT0#	VME_D12
6	VME_D5	VME_BGIN1#	VME_D13
7	VME_D6	VME_BGOUT1#	VME_D14
8	VME_D7	VME_BGIN2#	VME_D15
9	GND	VME_BGOUT2#	GND
10	VME_SYSCLK	VME_BGIN3#	VME_SYSFAIL#
11	GND	VME_BGOUT3#	VME_BERR#
12	VME_DS1#	VME_BR0#	VME_SYSRST#
13	VME_DS0#	VME_BR1#	VME_LWORD#
14	VME_WRITE#	VME_BR2#	VME_AM5
15	GND	VME_BR3#	VME_A23
16	VME_DTACK#	VME_AM0	VME_A22
17	GND	VME_AM1	VME_A21
18	VME_AS#	VME_AM2	VME_A20
19	GND	VME_AM3	VME_A19
20	VME_IACK#	GND	VME_A18
21	VME_IACKIN#	NC	VME_A17
22	VME_IACKOUT#	NC	VME_A16
23	VME_AM4	GND	VME_A15
24	VME_A7	VME_IRQ7#	VME_A14
25	VME_A6	VME_IRQ6#	VME_A13
26	VME_A5	VME_IRQ5#	VME_A12
27	VME_A4	VME_IRQ4#	VME_A11
28	VME_A3	VME_IRQ3#	VME_A10
29	VME_A2	VME_IRQ2#	VME_A9
30	VME_A1	VME_IRQ1#	VME_A8
31	-12V	NC	+12V
32	+5V	+5V	+5V

Figure 8-2 : VMEbus P1 Connector



## Artisan Technology Group is your source for quality new and certified-used/pre-owned equipment

- FAST SHIPPING AND DELIVERY
- TENS OF THOUSANDS OF IN-STOCK ITEMS
- EQUIPMENT DEMOS
- HUNDREDS OF MANUFACTURERS SUPPORTED
- LEASING/MONTHLY RENTALS
- ITAR CERTIFIED SECURE ASSET SOLUTIONS

### SERVICE CENTER REPAIRS

Experienced engineers and technicians on staff at our full-service, in-house repair center

### *InstraView*<sup>SM</sup> REMOTE INSPECTION

Remotely inspect equipment before purchasing with our interactive website at [www.instraview.com](http://www.instraview.com) ↗

### WE BUY USED EQUIPMENT

Sell your excess, underutilized, and idle used equipment. We also offer credit for buy-backs and trade-ins. [www.artisanng.com/WeBuyEquipment](http://www.artisanng.com/WeBuyEquipment) ↗

### LOOKING FOR MORE INFORMATION?

Visit us on the web at [www.artisanng.com](http://www.artisanng.com) ↗ for more information on price quotations, drivers, technical specifications, manuals, and documentation

**Contact us:** (888) 88-SOURCE | [sales@artisanng.com](mailto:sales@artisanng.com) | [www.artisanng.com](http://www.artisanng.com)