



Artisan Technology Group is your source for quality new and certified-used/pre-owned equipment

- FAST SHIPPING AND DELIVERY
- TENS OF THOUSANDS OF IN-STOCK ITEMS
- EQUIPMENT DEMOS
- HUNDREDS OF MANUFACTURERS SUPPORTED
- LEASING/MONTHLY RENTALS
- ITAR CERTIFIED SECURE ASSET SOLUTIONS

SERVICE CENTER REPAIRS

Experienced engineers and technicians on staff at our full-service, in-house repair center

*InstraView*SM REMOTE INSPECTION

Remotely inspect equipment before purchasing with our interactive website at www.instraview.com ↗

WE BUY USED EQUIPMENT

Sell your excess, underutilized, and idle used equipment. We also offer credit for buy-backs and trade-ins. www.artisanng.com/WeBuyEquipment ↗

LOOKING FOR MORE INFORMATION?

Visit us on the web at www.artisanng.com ↗ for more information on price quotations, drivers, technical specifications, manuals, and documentation

Contact us: (888) 88-SOURCE | sales@artisanng.com | www.artisanng.com

FEATURES

- ❖ Variable “on the fly” microstepping for high resolution, high speed operation
- ❖ Master, slave two axis control
- ❖ Simple programming using a mnemonic code
- ❖ Serial communications supporting RS-232, RS-422 and RS-485
- ❖ Eight general purpose bi-directional user programmable input/output ports.
- ❖ 1792 bytes of NVRAM available for user programs
- ❖ Off line 120/240 VAC 50/60 Hz
- ❖ Patented 4-phase Bipolar Chopper Drive for superior current regulation and low ripple current
- ❖ Output current adjustable from 0.625 A to 5 A_{RMS} with 3 position DIP switch
- ❖ Microstepping for smooth operation and increased resolution
- ❖ Wide Speed Range
- ❖ Stable over operating temperature range ($\pm 1\%$)
- ❖ Switch selectable Step Size and Current
- ❖ Patented Digital Electronic Damping reduces instability at mid-speed ranges
- ❖ Adjustable Idle Current Reduction
- ❖ External Pulse Output
- ❖ Drive Fault protection:
 - Line-to-line and line-to-neutral shorts
- ❖ Power supply fault protection:
 - Over temperature
 - Short circuit
 - Under voltage
- ❖ Output for 2nd Axis (J6)
 - 66 VDC ± 2 volts available via three position plug-in connector to power additional axis (total power available for internal and external axis = 300 W)
- ❖ Small size - 6.25in x 2.25in x 12.50in
- ❖ UL and CSA recognition pending
- ❖ CE conformance pending

APPLICATIONS

- ❖ Clutch Brake Replacement
- ❖ Labeling Machines
- ❖ Packaging/Specialty Machinery
- ❖ Smart Conveyor Systems
- ❖ Semiconductor Wafer Polishing
- ❖ Constant Speed Applications

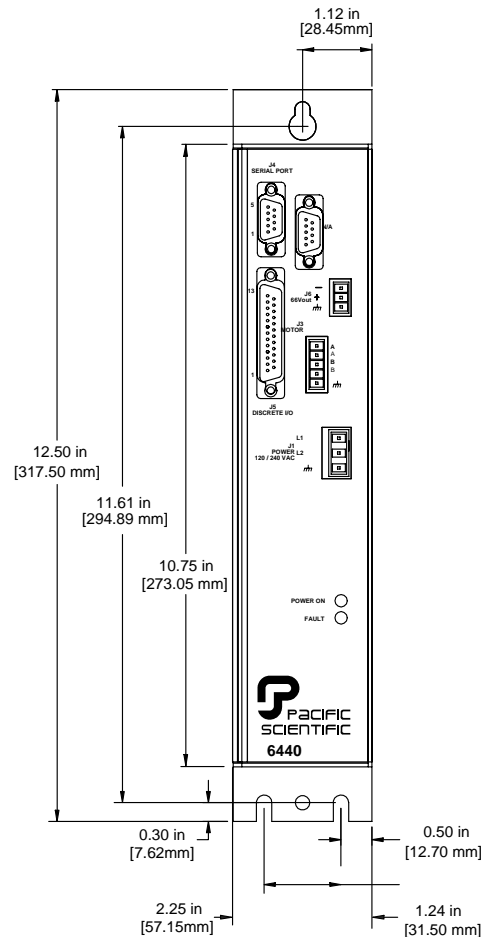

PRODUCT DESCRIPTION

The 6440 communicates with RS-232, RS-422 or RS-485 serial protocols at 9600 baud. A simple single letter mnemonic code is used. Discrete I/O lines provide external start/stop, motor enable, \pm limit \pm jog and home inputs, and motor moving, step and direction outputs. The eight bi-directional discrete I/O lines are individually jumper configurable for input or output. Inputs one through four can be used as a parallel interface to select up to 16 different move profiles. This is ideal for thumbwheel and PLC interfaces.

The 6440 operates in one of two modes; either Fixed Resolution or Variable Resolution. In Fixed Resolution Mode with binary steps, the step resolution can be set from 200 steps/rev to 51,200 steps/rev and with decimal resolution 200 steps/rev to 50,000 steps/rev. The step pulse rate varies from 0.08 to 19,000 pulses/sec therefore, higher step resolution limits shaft speed. In Variable Resolution Mode the step resolution is fixed to 20,000 steps/rev, and the speed ranges from 0.02 to 6000 RPM. The 6440 changes step size “on the fly” to provide both high speed and resolution.

This package can be set up for two axis master, slave control. The indexer can provide synchronous or alternating motion for two axes through its step and direction outputs. The motion profile is trapezoidal with independent programmable accel and decel rates.

Power-up Sign On

Power-up sign-on message returned after entry of ESC key and then 1 space.

Special Memory locations

REMOTE START at address 0.

Power-up AUTOSTART program at address 1600.

FAST memory 128-191.

SPECIFICATIONS

Input Power

Voltage	120/240 VAC 60/50 Hz (switch selectable)
Line Current	At full (300 W) load 240 VAC, 2.3 A _{RMS} 120 VAC, 3.5 A _{RMS}
Output motor phase current	5 A _{RMS} max. 5 A peak full step, 7.1 A peak microstepping Adjustable from 0.625 to 5 A _{RMS} in 0.625 amp increments
66 Vdc Output for 2nd axis (J6)	66 ±2 volts. Total power (internal + external) = 300 W
Discrete Input Voltage	0 - 30 VDC max, V _{in} 0.8V is a logic low and V _{in} = 3.7V is a logic high.
Discrete Output Voltage	Open Collector 30 VDC, 70 mA sink, V _{SAT} 1.0 VDC
<u>Inputs</u>	
Dedicated Inputs	Start, stop, enable motor, ± limit, ± jog and home
Programmable inputs	8 available jumper selectable. There are 8 total inputs and outputs.
<u>Outputs</u>	
Opto Supply	+5.7 VDC at 100 mA
Dedicated Outputs	Motor moving, fault, step and direction
Programmable Outputs	8 available jumper selectable. There are 8 total inputs and outputs.

Step Size	Min. Speed RPM (full steps/sec)	Max. Speed RPM (full steps/sec)	Resolution Pulses/rev.
Fixed Resolution - Binary Steps			
Full	6 (20)	5700 (19,000)	200
1/2	3 (10)	3000 (10,000)	400
1/4	1.5 (5)	1500 (5000)	800
1/8	0.75 (2.5)	750 (2500)	1,600
1/16	0.37 (1.25)	375 (1250)	3,200
1/32	0.19 (.625)	188 (635)	6,400
1/64	0.09 (.312)	93.75 (312)	12,800
1/128	0.05 (.156)	46.87 (156)	25,600
1/256	0.02 (.078)	23.43 (78)	51,200
Variable Resolution			
	0.02 (.078)	5700 (19,000)	20,000

Idle Current Reduction Enabled or disabled with DIP switch, 50% output current reduction after 0.1 second from last step command.

Digital Electronic Damping Enabled or disabled with DIP switch.
Max delay from input step change in motor excitation:
Step frequency < 500 full steps/sec: 500 ms
Step frequency > 500 full steps/sec: 270° of step period

Environmental Requirements

Storage temperature -40° C to +70° C
Operating temperature 0 to 50° C ambient, 50° C to 60° C (derated)
Altitude 5000 ft (1500 m) by design
Humidity Range 10% to 90%, non-condensing
Vibration IEC Standard 68-2-6 Pending

Mechanical

Dimensions 6.25 in x 2.25 in x 12.50 in
Weight 6 lbs nominal

Connectors

AC Power Phoenix MCI, 5/3-G-3,81 connector. Mating connector: Phoenix MCI, 5/3-ST-3,81.
Motor PCD ELVH0510 connector. Mating connector: PCD ELVP05100.
66 VDC Output PCD ELVH0310 connector. Mating connector: PCD ELVP03100
Serial 9 contact female D connector, Mating connector: ITT Cannon DE-9P with ITT Cannon DE110963 Hood and D20419 Clamp Kit.
Discrete I/O 25 contact female D connector. Mating connector: ITT Cannon DB25S with ITT Cannon DB110963 Hood and D20419 Clamp Kit

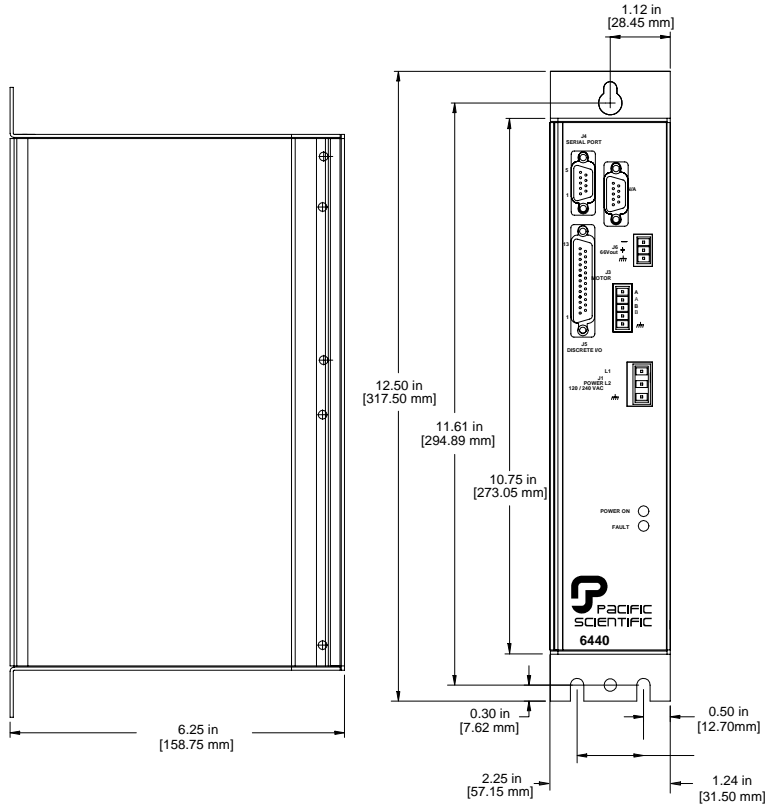

Note: Jumpers are factory installed. They are not to be modified in the field.

JUMPERS 5-6 & 7-8
INSTALLED AT FACTORY
DO NOT CHANGE

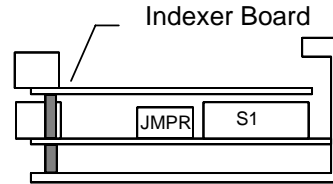
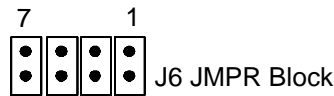

Side View

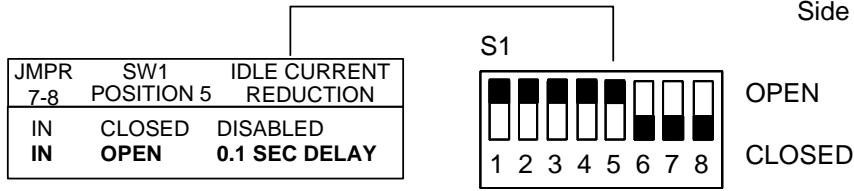

SW1 POSITIONS
1-3 OPEN ON 6440

SW1 POSITION 4	DIGITAL ELECTRONIC DAMPING CONTROL
CLOSED	DISABLED
OPEN	ENABLED

SW1 POSITION			Motor Current Amps RMS
6	7	8	
CLOSED	CLOSED	CLOSED	5.0
CLOSED	CLOSED	OPEN	4.375
CLOSED	OPEN	CLOSED	3.750
CLOSED	OPEN	OPEN	3.125
OPEN	CLOSED	CLOSED	2.5
OPEN	CLOSED	OPEN	1.875
OPEN	OPEN	CLOSED	1.25
OPEN	OPEN	OPEN	.625

DRIVER BOARD SETTINGS

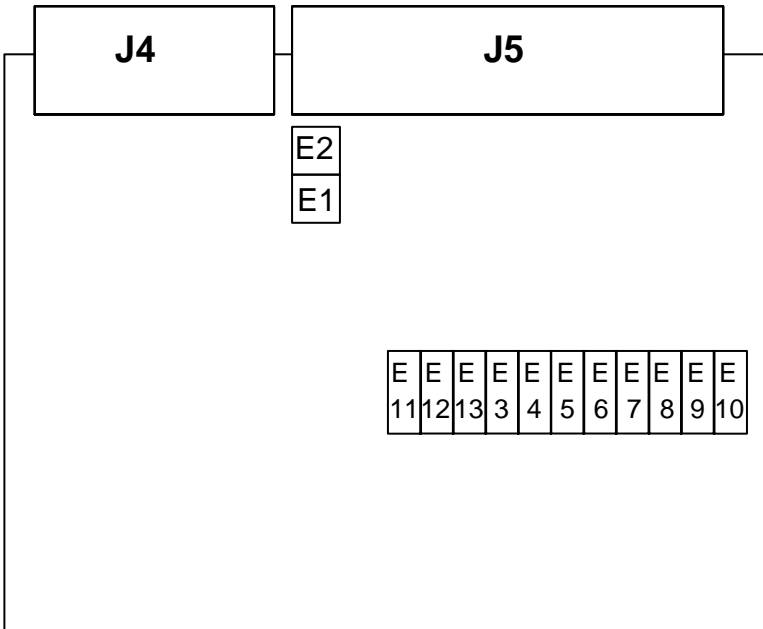

E1 and E2, Factory setting: E1 IN, E2 OUT. Should NOT be modified by user.

E11 IN enables RS-485 multi-unit communication, OUT for RS-232/RS-422. *Factory setting: Jumper OUT enabling RS-232 and RS-422 communications.*

E12 and E13 control slave 6410 Drive operation. E12 IN, E13 OUT for alternating operation, E12 OUT, E13 IN for synchronous operation. *Factory setting: Jumpers E12 IN, E13 OUT.*

E3 to E10 control discrete I/O Port 1 to 8 configurations. Jumper IN to configure as an output, jumper OUT to configure as an input. *Factory setting: All jumpers OUT configuring all lines as INPUTS.*

INDEXER BOARD SETTINGS

Ports are active LOW; a logic 0 applied to an input port reads back as a "1" and vice-versa.

DEDICATED & PROGRAMMABLE INPUT/OUTPUT LINES

The 6440's operation is controlled by several input lines. These lines are active low. Input lines are RC filtered and passed to a 74HC14 Schmidt Trigger. The electrical diagram of input and output lines are shown at right.

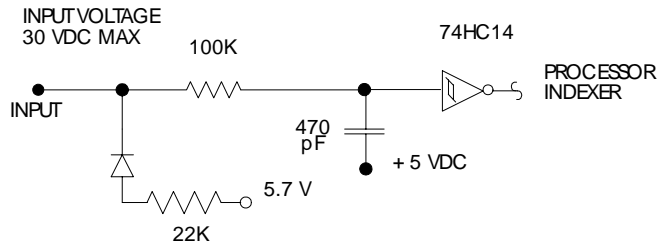

Note: Inputs accept 0-30 VDC max, where $V_{in} \leq 0.8 V$ is a logic low and $V_{in} \geq 3.7 V$ is a logic high.

The 6440's outputs are open-collector Darlington ULN2003 drives. Inductive kick-back protection is provided by the built-in diode and 39 V Zener diode.

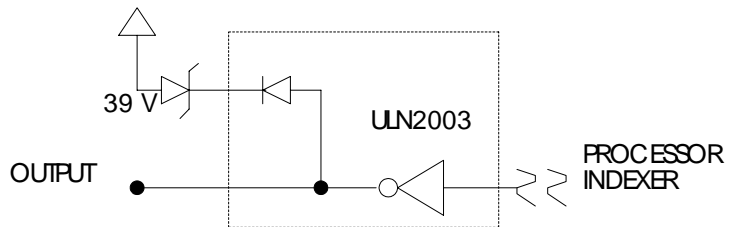

Note: All outputs are open collector 30 VDC, 70 mA sink, $V_{sat} \leq 1.0 V$. All I/O signals are I/O low.

CONNECTION DIAGRAM

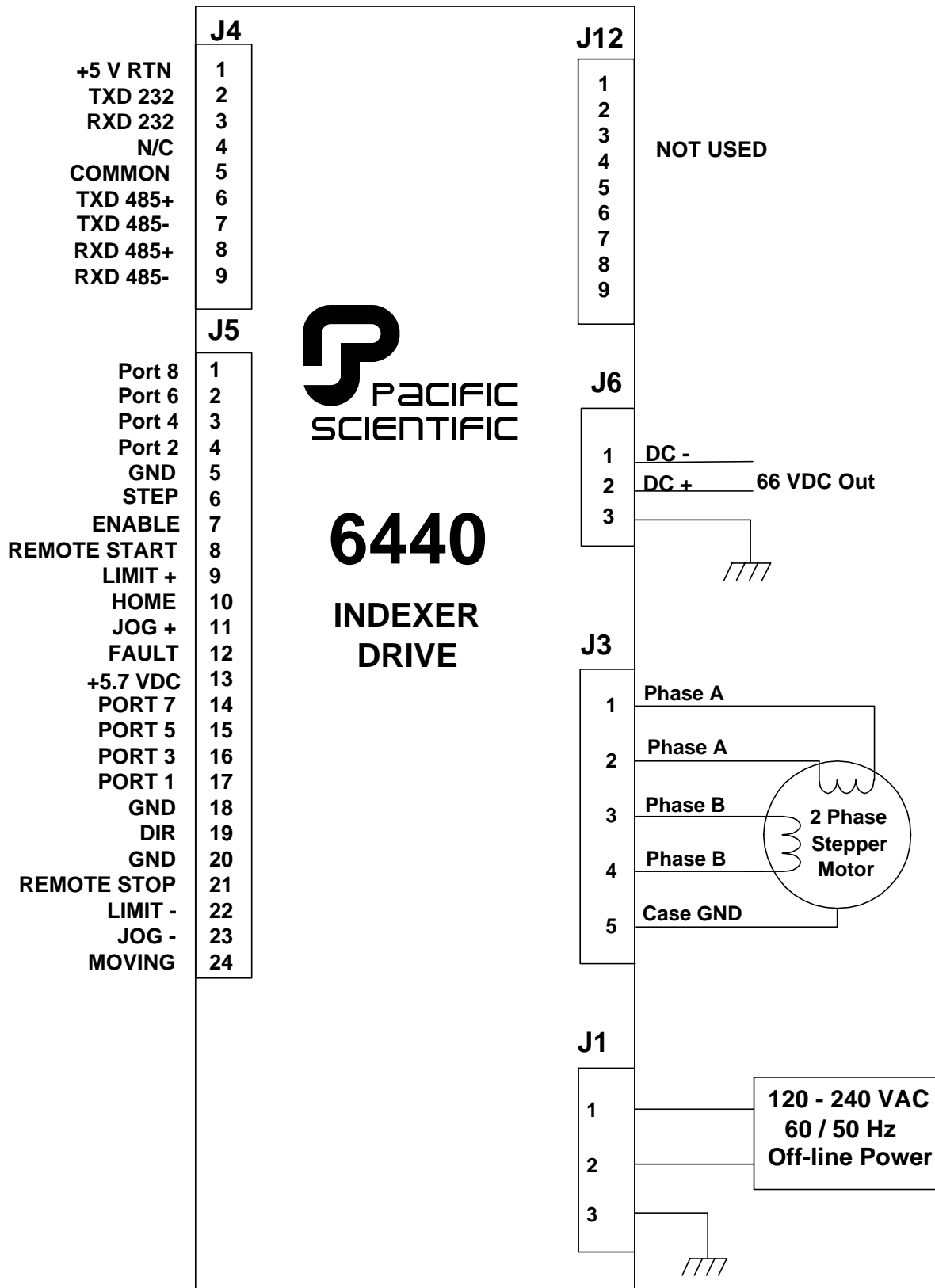

COMMAND SUMMARY

A (Clear and Restore) A *opcode*

A 0, reloads the last saved parameters from NVRAM, A 8 followed by A 9 completely initializes NVRAM to default values.

C (Read Position Counter) C *arg, arg is 0, 1* Specifying *arg = 1*, enables continuous echoing of position via the serial interface only in single-unit mode.

E (Edit Program) E *addr*, Edit program at address *addr*.

F (Initial Velocity) F *vel*, Sets the initial velocity to *vel* step pulses/second, $0 \leq vel \leq 19,000$.

G (Go) G *addr [trace]*, $0 \leq addr \leq 1791$, or 2048 for indexed jump on inputs, $0 \leq trace \leq 1$.

H (Home) H *speed dir*, where: $20 \leq speed \leq 19,000$ step pulses/second, *dir* must be 0 for CW and 1 for CCW motion towards Home position.

I (Resolution Mode) I *mode*. *mode = 0* selects Fixed Resolution Mode, *mode = 1* selects Variable Resolution Mode.

J, B (Jump Loop Nested) J, B *addr cntr*, $0 \leq addr \leq 1791$, $0 \leq cntr \leq 255$ for 1 to 256 iterations.

K (Read Input Port) K, Logic "0" input reads back as "1". Bit weightings 1-128 correspond to port 1 to 8. Jumpers E3 to E10 control direction of I/O ports. Jumper OUT for input, IN for output.

L (List Program) L *addr*, List Program. $0 \leq addr \leq 1791$. Returns up to 20 lines at a time.

M (Accel/Decel Factor) M *accel decel*, $5 \leq accel \leq 255$, $5 \leq decel \leq 255$.

O (Trip Point) O *position vaddr*, Set Trip Point. $-8,388,607 \leq position \leq +8,388,607$, $0 \leq vaddr \leq 1791$.

P (Store Parameters), Stores parameters to non-volatile memory.

Q (Examine Parameters) Q Displays Initial, Final Velocity, Accel/decel factors etc.

R (Run at constant velocity) R *vel*, $20 \leq vel \leq 19,000$ step pulses/second.

S (Stop) S [*arg*], Embedded in a program, S 0, will cease motion but the program will continue, S 1 terminates

program, placing the indexer into immediate mode.

T (Master/Slave Control) T *enb*, *Alternating axis operation*: E12 IN, E13 OUT, T 1 enables master, disables slave. T 0 disables master, enables slave. *Synchronous Operation*: E12 OUT, E13 IN, T 1 enables master and slave. T 0 disables both.

U (Loop on Port) U *addr cond*, Tests a port and jumps if condition is satisfied. $0 \leq addr \leq 1791$. Port 1 to 8 HIGH 0, 2, 4, 6, 8, 10, 12, 14, Port 1 to 8 LOW 1, 3, 5, 7, 9, 11, 13, 15

V (Final Velocity) V *vel*, Sets the final velocity of an absolute (at) or incremental (\pm) move. Expressed as $0 \leq vel \leq 19,000$ step pulses/second.

W (Wait) W *period*, Wait. $0 \leq period \leq 65535$, 10ms resolution, with 0 as wait for end of motion This command returns the status of the limit, home and jog switches and the Drive Fault status. The value of *arg* specifies whether limit switch or input line information is returned.

X (Read Limits) X *arg*, Specifying X 0 returns 1 for Limit + active, 2 for Limit - active and 3 for both active. Bit 7 is active high if the drive has faulted. Specifying X 1, returns a binary weighted value corresponding to the level of these signals: 1 = Home Input, 32 = Jog - Input, 64 = Jog + Input, 128 = Drive Fault.

Y (Write Output Port) Y *port*, Write Port. $0 \leq port \leq 255$, Y 0 deactivates all bits producing Logic HIGHs, Y 255 activates all bits producing Logic LOWs.

Z (Zero Origin), Zeros position counter.

^ (Set Jog Speed) ^ *speed*, Sets jog speed, $0 \leq speed \leq 255$. Actual speed is $30 * speed$ step pulses/second.

@ (Absolute Move) @ *position*, Absolute Index
In Fixed Resolution:
 $-8,388,607 \leq position \leq +8,388,607$.
Variable Resolution:
 $-8,388,607.99 \leq position \leq +8,388,607.99$ with 0.01 resolution.

+ (Positive Incremental Move) + *steps*, Positive Incremental Index.
Fixed Resolution: $0 \leq steps \leq +8,388,607$. Variable Resolution, $0.00 \leq steps \leq +8,388,607.99$.

- (Negative Incremental Move) - *steps*, Negative Incremental Index.

Fixed Resolution: $0 \leq steps \leq +8,388,607$. Variable Resolution, $0.00 \leq steps \leq +8,388,607.99$.

^C or ESC (Software Reset), Stops all activity. Indexer will wait for the space bar sign-on or external Remote Start or Jog pulse inputs.

**\ (Step Size, VelScale) ** *arg*. Sets the step size in Fixed Resolution Mode, binary and decimal step sizes. In Variable Resolution Mode, scales the step pulse rates. For $0 \leq arg \leq 8$:

Fixed Binary	Fixed Decimal	VR Speed
0 = Full	Not allowed	Full Speed
1 = 1/2	Full	1/2
2 = 1/4	1/2	1/4
3 = 1/8	1/5	1/8
4 = 1/16	1/10	1/16
5 = 1/32	1/25	1/32
6 = 1/64	1/50	1/64
7 = 1/128	1/125	1/128
8 = 1/256	1/250	1/256

> (Read Memory), *> addr size*, $0 \leq addr \leq 2047$, $0 \leq size \leq 255$ bytes. Displays a block of memory starting at *addr* in decimal format, returning a total of *size* bytes.

< (Write Memory), *< addr data*, $0 \leq addr \leq 2047$, $0 \leq data \leq 255$. Writes a *data* byte to an address specified by *addr* in memory.

] (Read Moving Status), **] Returns a decimal number representing the current move status. Bit weights: 1 = Indexing, 2 = Constant, 128 = Drive Fault**

' (Trip and Output), *' nextpos port*. $0 \leq nextpos \leq +8,388,607$, $0 \leq port \leq 255$. Used within a Trip Point Service Routine (TPSR) and provides the capability of setting or clearing user I/O lines as a function of current position. The value *port* is written to the I/O ports when the previously set position is reached. Next trip point set to position *nextpos*.

= (Limit Switch Polarity), = *polarity*
0 = default active LOW limit input,
1 = active HIGH limit input

: (Selective Termination), : *axis*
Aborts operations on a particular axis when configured for RS-485 communications mode.

AC SWITCH SETTINGS

The AC switch is preset at the factory in the 230 VAC position. The E Jumper and AC switch settings are easily accessible by opening the cover. **First, make certain the power connections have been removed.** Rest the unit on its side as shown. Remove the four screws toward the back of the unit. Select appropriate setting. Replace cover and mounting screws. Do **NOT** over tighten mounting screws. (5.0 in-lbs max)

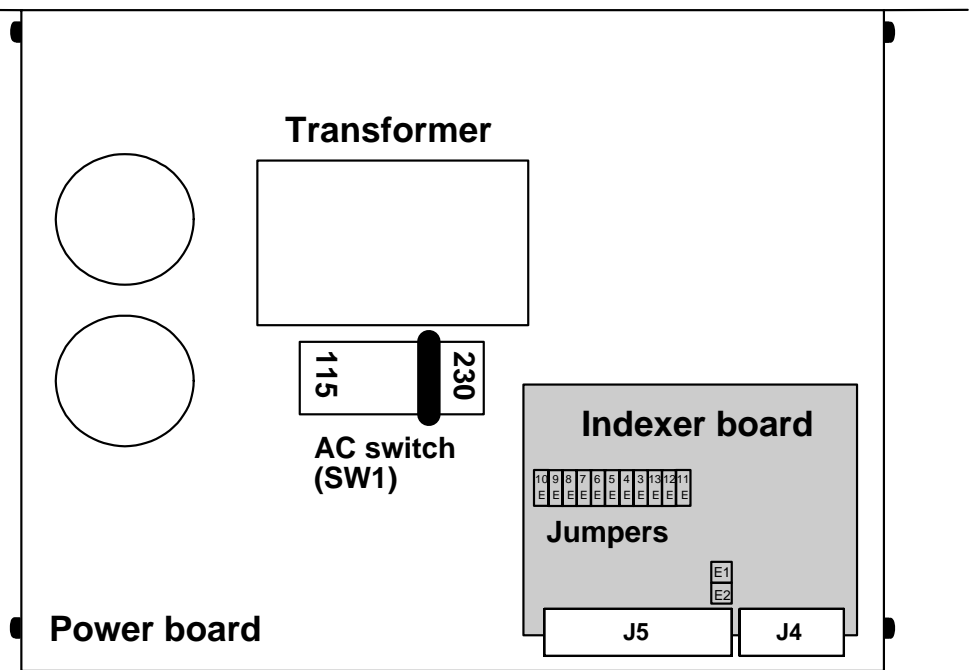

66 VDC OUTPUT CONNECTOR J6

The 6440 package has an external 66 VDC connector designed to power an additional drive. The total power available for both the internal and external drives is 66 VDC at 4.6 amps or approximately 300 watts. If the two drives are running simultaneously and require more than 4.6 amps, the voltage will begin to cut back. The power supply has a low voltage protection circuit that will fault the drive if the DC supply dips below 55 VDC.

A twisted pair plus ground cable utilizing 16, 18, or 20 gauge wire is recommended to connect the remote connector to the external drive. A 470 μ f 100 VDC aluminum electrolytic capacitor, rated for 2A ripple current or greater, must be installed at the additional drive if the cable length is over 3 feet.

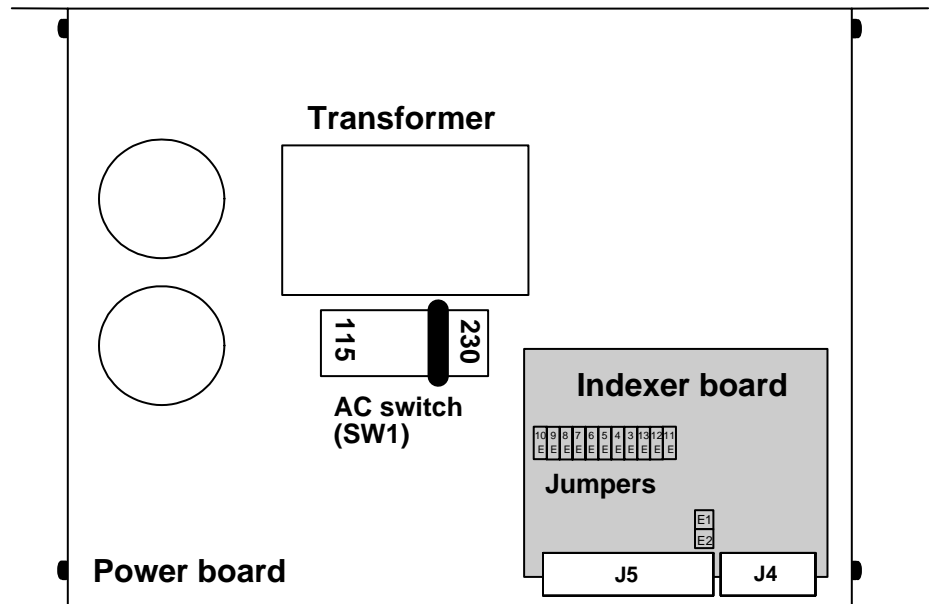

TROUBLESHOOTING

Power Board

SYMPTOM	POSSIBLE CAUSE	ACTION
Motor does not turn, LEDs ON (green and/or red)	120/240 VAC switch in 240 position, input from 120 VAC	Turn power off, correct switch position.
	AC Input line low	Increase Input AC to spec.
	Dead short or overload across external 66 VDC output connector (J6).	Remove short or reduce load.
	Over temperature	Check ambient temperature or internal fan malfunction/blockage.
	Bad load connection	Check load connection. Check J6 VDC output with a voltmeter and ensure output voltage is 66 V \pm 2%. 1. If output voltage > 70 VDC and < 78 VDC add a load and ensure VDC is \approx 66 VDC. 2. If output voltage > 78 VDC, return 6440 to factory for service.
Motor does not turn, LEDs OFF	Drive board fault	See Table below.
	Check AC input	Use proper input.
Motor runs for a while and stops, both LEDs come on	240 VAC applied and switch in 120 VAC position.	Return to factory for service.
	Over temperature.	Reduce load. Check for excessive ambient temperature. Check for internal fan malfunction/blockage.
Motor turns on and off on its own and red LED flashes	120 VAC applied and switch in 240 VAC position	Correct switch position.
	Over load.	Reduce load.
OR	AC input line low.	Check input AC line voltage for low line.
	Drive Board Fault.	See table below
Motor stops after running once.	Internal failure.	Return to factory for service.

Drive Board

SYMPTOM	CORRECTIVE ACTION
Motor produces no torque.	Disconnect AC Power. Disconnect the motor cable and cycle the J1 power supply Off and On. Check the step output and VCO input monitor point. Also, check motor cable and motor for shorts across the windings or between the windings and the motor case.
	Verify that DIP Switch S1 position 6, 7, and 8 (current select) are set correctly. Re-check that the motor cable is wired correctly and properly plugged into the drive.
Motor rotates in the wrong direction.	Check polarity of the DIRECTION input. Reverse the A and A motor phases.
Motor does not reach expected position.	Check that the step size setting of the drive is set correctly. Verify that the motor does not stall. If it does: 1. Use a finer step size to avoid low-speed resonance problems 2. Enable Digital Electronic Damping (S1 position 4 OFF).

Indexer Board

SYMPTOM	CORRECTIVE ACTION
Motor doesn't spin	<p>Verify that the motor is properly connected with no open wires or shorts.</p> <p>With the 6440 energized, try twisting the motor shaft. If you're able to easily spin the shaft, especially at the higher motor current levels, chances are the motor is disabled. J5-7 (ENABLE) should be wired to J5-5 (GND).</p> <p>Verify that some motor problem has not created a Fault condition. A FAULT has occurred if J5 pin 12 is low or the Read HW status command returns with Bit 7 high. If so, correct the condition that created the fault.</p> <p>If you issued the T command with Indexer jumpers E12 and E13 set for alternating operation, you may have disabled step pulses to the motor. Double check your jumper configuration and usage of the T command.</p>
Motor spins, but tends to stall	<p>Experiment with the M command by issuing M 255 255 which results in the slowest possible acceleration and deceleration.</p> <p>Possibly your motor cannot generate enough torque for your application. Try resizing.</p>
Unit will not respond to commands	<p>If the power supply is not adequate for the load, a momentary drop in power may reset the unit, and require that the sign-on procedure be repeated.</p> <p>It is possible a maximum velocity value, well above the specified range may have been executed. Try cycling power and resetting any erroneous parameters before issuing another motion command. If the error occurs in an AUTOSTART program, try ESCaping as soon as possible before the maximum velocity is attained.</p> <p>Cycle power.</p>

Communications Interface

SYMPTOM	CORRECTIVE ACTION
No RS-232 Communication	<p>Verify that the 6440 E11 jumper is OUT, placing the 6440 into single-unit, RS-232/RS-422 mode.</p> <p>Verify that the transmit of the host terminal is wired to the 6440 receive and vice-versa. Normally DTE (Data Terminal Equipment) devices transmit data on pin 2 and receive data on pin 3.</p> <p>Verify the serial port settings to be 9600, N, 1.</p> <p>Make sure your host is working properly. Disconnect the D-9 connector from the 6440 unit. Wire pins 2 and 3 of this connector together. Try typing characters on the keyboard, each character should be echoed back to the screen. If not, check your cabling and connectors and refer to your host reference guide.</p>

Customer Support

Danaher Motion products are available world-wide through an extensive authorized distributor network. These distributors offer literature, technical assistance, and a wide range of models off the shelf for the fastest possible delivery.

Danaher Motion sales engineers are conveniently located to provide prompt attention to customer needs. Call the nearest office for ordering and application information and assistance or for the address of the closest authorized distributor. If you do not know who your sales representative is, contact us at:

Danaher Motion
 203A West Rock Road
 Radford, VA 24141 USA
Phone: 1-540-633-3400
Fax: 1-540-639-4162

Email: customer.support@danahermotion.com

Website: www.DanaherMotion.com

PERFORMANCE - 6400 SERIES CONTROLS

Motors will perform as shown without the winding temperature exceeding a rise of 90° C. When the motor is operated unmounted (without heat sink) in an ambient temperature of up to 40° C. The curves do not reflect systems resonance points, which will vary with motor coupling and systems parameters.

In addition to those shown below, Danaher Motion offers a wide range of other motor windings to meet specific performance requirements.

Torque/Speed Curves - Recommended Motors for 5.0 A operation

(3" MOTOR-ONE ROTOR STACK)

E31NX-HTLNN-NS50
5.0 A/65 V PER PHASE

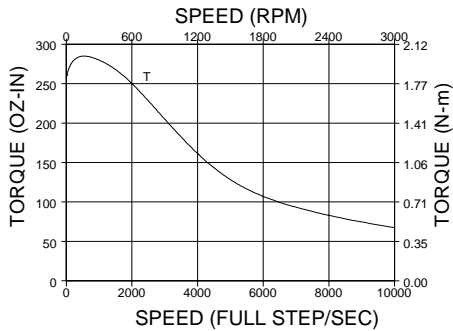

(3" MOTOR-TWO ROTOR STACK)

E32NX-HTLNN-NS50
E32NX-HPLNN-NS50
5.0 A/65 V PER PHASE

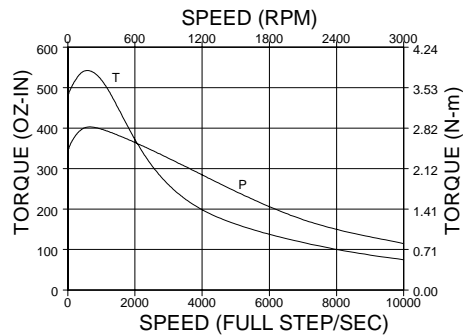

(3" MOTOR-THREE ROTOR STACKS)

E33NX-HTLNN-NS50
E33NX-HPLNN-NS50
5.0 A/65 V PER PHASE

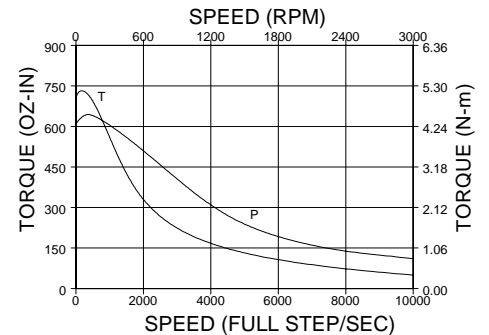

(3" MOTOR-FOUR ROTOR STACKS)

E34HX-HTLNN-NS50
E32HX-HPLNN-NS50
5.0 A/65 V PER PHASE

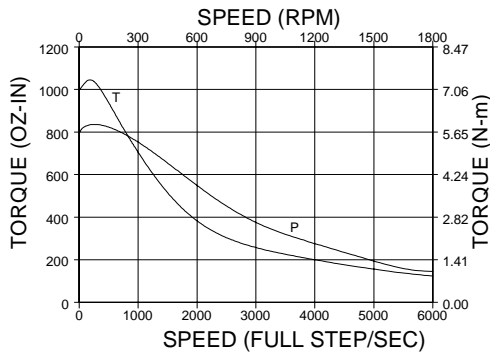

(4" MOTOR-ONE ROTOR STACK)

E41HX-HTLNN-NS50
5.0 A/65 V PER PHASE

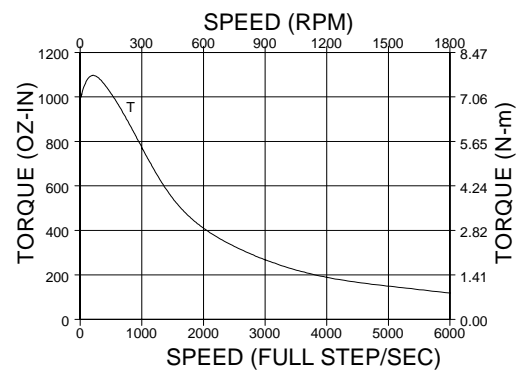

Torque/Speed Curves - Recommended Motors for 2.5 A Operation

(3" MOTOR-ONE ROTOR STACK)

E31NX-LTLNN-NS50
E31NX-LPLNN-NS50
2.5 A/65 V PER PHASE

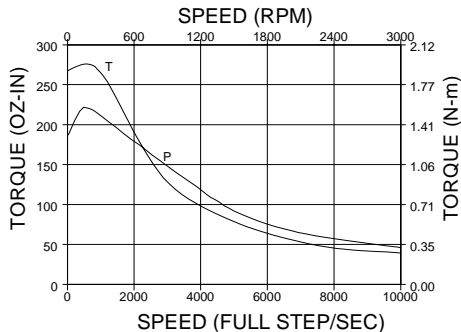

(3" MOTOR-TWO ROTOR STACK)

E32NX-LTLNN-NS50
E32NX-LPLNN-NS50
2.5 A/65 V PER PHASE

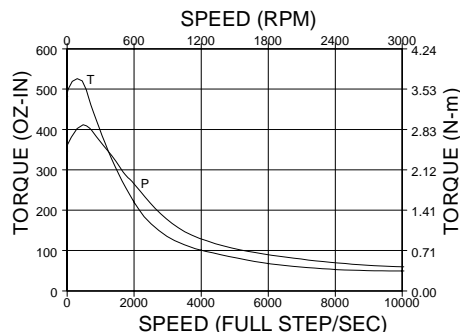

(2" MOTOR-TWO ROTOR STACKS)

E22NX-LTLNN-NS50
E22NX-LPLNN-NS50
2.5 A/65 V PER PHASE

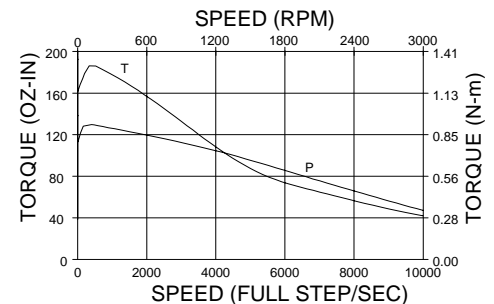



Artisan Technology Group is your source for quality new and certified-used/pre-owned equipment

- FAST SHIPPING AND DELIVERY
- TENS OF THOUSANDS OF IN-STOCK ITEMS
- EQUIPMENT DEMOS
- HUNDREDS OF MANUFACTURERS SUPPORTED
- LEASING/MONTHLY RENTALS
- ITAR CERTIFIED SECURE ASSET SOLUTIONS

SERVICE CENTER REPAIRS

Experienced engineers and technicians on staff at our full-service, in-house repair center

*InstraView*SM REMOTE INSPECTION

Remotely inspect equipment before purchasing with our interactive website at www.instraview.com ↗

WE BUY USED EQUIPMENT

Sell your excess, underutilized, and idle used equipment. We also offer credit for buy-backs and trade-ins. www.artisanng.com/WeBuyEquipment ↗

LOOKING FOR MORE INFORMATION?

Visit us on the web at www.artisanng.com ↗ for more information on price quotations, drivers, technical specifications, manuals, and documentation

Contact us: (888) 88-SOURCE | sales@artisanng.com | www.artisanng.com