



Artisan Technology Group is your source for quality new and certified-used/pre-owned equipment

- FAST SHIPPING AND DELIVERY
- TENS OF THOUSANDS OF IN-STOCK ITEMS
- EQUIPMENT DEMOS
- HUNDREDS OF MANUFACTURERS SUPPORTED
- LEASING/MONTHLY RENTALS
- ITAR CERTIFIED SECURE ASSET SOLUTIONS

SERVICE CENTER REPAIRS

Experienced engineers and technicians on staff at our full-service, in-house repair center

*InstraView*SM REMOTE INSPECTION

Remotely inspect equipment before purchasing with our interactive website at www.instraview.com ↗

WE BUY USED EQUIPMENT

Sell your excess, underutilized, and idle used equipment. We also offer credit for buy-backs and trade-ins. www.artisanng.com/WeBuyEquipment ↗

LOOKING FOR MORE INFORMATION?

Visit us on the web at www.artisanng.com ↗ for more information on price quotations, drivers, technical specifications, manuals, and documentation

Contact us: (888) 88-SOURCE | sales@artisanng.com | www.artisanng.com

**DIGIFLEX® DIGITAL SERVO DRIVES
WITH CANopen INTERFACE
MODELS: DX15CO8, DX15CO8-SRC**

FEATURES:

- Fully digital, state-of-the-art design
- Brushed DC, brushless AC drive technology
- Digital current, velocity, and position loops with programmable gain settings
- Hall sensor commutation feedback for brushless motors
- Surface-mount technology
- Small size, low cost, ease of use
- Isolated CAN bus interface for setup and networking
- Supports CANopen communication protocol (DS301) and Device Profile for Drives and Motion Control commands (DSP-402)
- CAN bus address and bit rate selection via DIP-switches
- Windows© based DigiFlex® DriveWare setup software via CAN interface (operates with third party PC-to-CAN interface)
- Operates in torque, velocity or position mode
- Dual encoder input
- 7 programmable isolated digital inputs (sinking), sourcing inputs optional (-SRC).
- 8 programmable isolated digital outputs (sinking)
- Dedicated isolated limit and home switch inputs
- 3 programmable analog inputs (12-bit)
- 1 programmable analog output (10-bit)
- Four quadrant regenerative operation
- Agency Approvals:
 - Separate logic supply voltage (single supply optional)
 - Bi-color LED status indicator
 - Extensive built-in protection against:
 - over-voltage
 - under-voltage
 - short-circuit: phase-phase, phase-ground
 - over-current
 - over-temperature with pre-warning



ADVANCED MOTION CONTROLS
3805 Calle Tecate, Camarillo, CA 93012
Tel: (805) 389-1935, Fax: (805) 389-1165

BLOCK DIAGRAM:

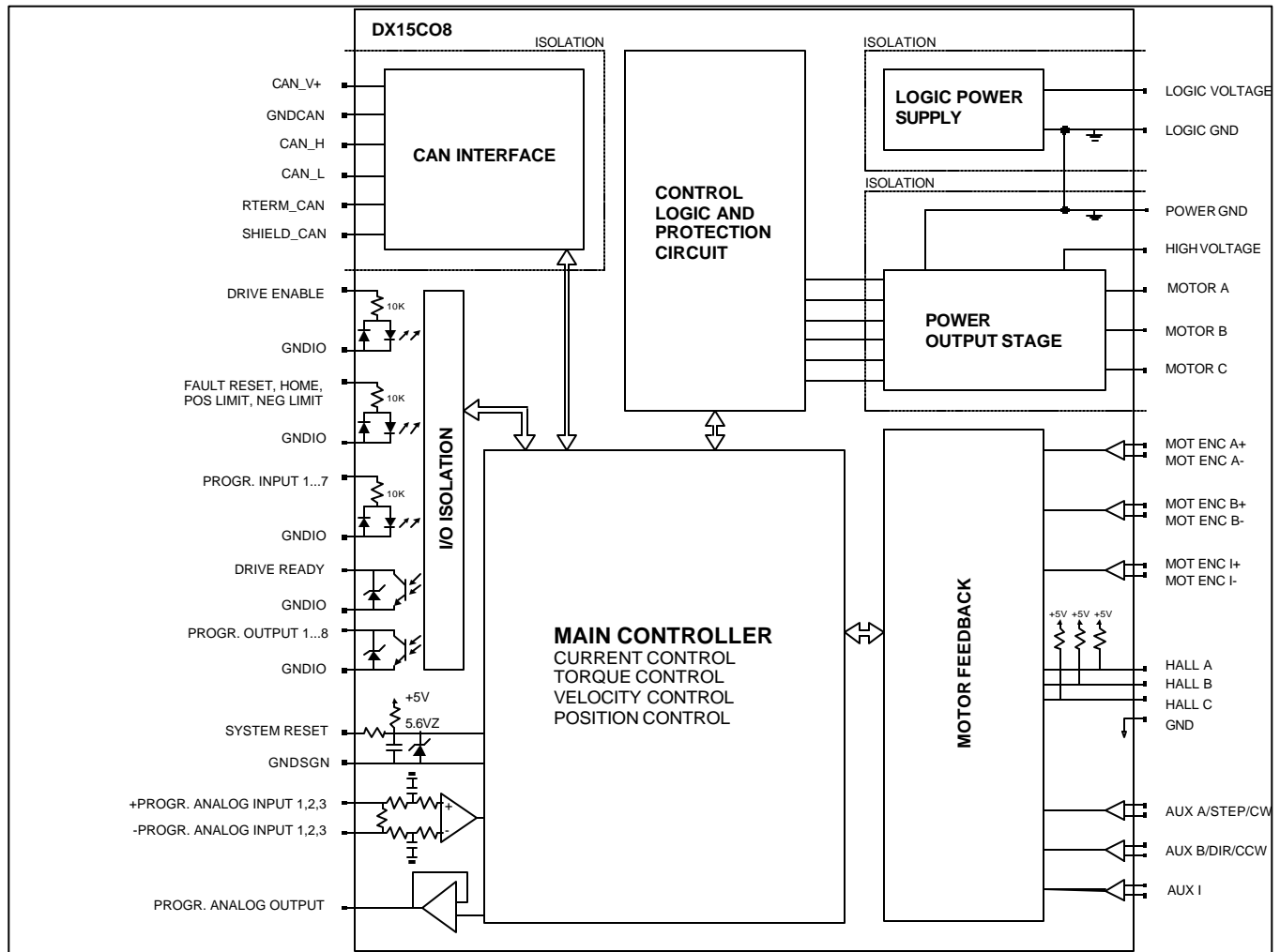

DESCRIPTION:

The DX15CO8 Series digital PWM servo drives are designed to drive brushed and brushless servomotors. These fully digital drives can operate in torque, velocity, or position mode. Various feedback signals can be used to close the velocity and position loop. The command source can be generated internally or can be supplied externally. In addition to motor control, these drives feature dedicated and programmable digital and analog inputs and outputs to enhance interfacing with external controllers and devices.

DX15CO8 Series drives feature a single CAN interface which supports the CANopen protocol (DS301 and DSP402). This interface is used for drive configuration and setup as well as online operation in networked applications. Drive commissioning can be accomplished through DigiFlex® DriveWare, a fully graphical Windows© based application.

Torque, velocity, or position commands can be generated from an analog input, the auxiliary encoder input, a preset index table, or the CAN interface. The DX15CO8 also features an interpolated position mode with cubic interpolation for smooth, coordinated, multi-axis position control via the CAN interface. A homing routine based on the home switch input and/or the encoder index pulse is also implemented.

All drive and motor parameters are stored in non-volatile memory.

SPECIFICATIONS:

POWER STAGE SPECIFICATIONS	DX15CO8, DX15CO8-SRC
DC SUPPLY VOLTAGE	24...75 VDC
PEAK CURRENT	15 A (if heat sink temperature is <50°C)
MAXIMUM CONTINUOUS CURRENT	8 A
MINIMUM LOAD INDUCTANCE	250 µH
SWITCHING FREQUENCY	20 kHz
HEATSINK (BASEPLATE) TEMPERATURE RANGE	0 to 65 °C, disables at 65 °C
POWER DISSIPATION AT CONTINUOUS CURRENT	30W
UNDER VOLTAGE SHUTDOWN	18 VDC
OVER-VOLTAGE SHUTDOWN	88 VDC

LOGIC SUPPLY SPECIFICATIONS	
DC SUPPLY VOLTAGE	20...80 VDC
MAXIMUM RIPPLE	10%
INPUT POWER	10W max.

CAN INTERFACE SUPPLY SPECIFICATIONS	
DC SUPPLY VOLTAGE	7.5 to 13 VDC
INPUT CURRENT	150 mA max.

MECHANICAL SPECIFICATIONS	
POWER CONNECTOR: P1	Screw terminals
MOTOR FEEDBACK CONNECTOR: P2*	15-pin high density female D-sub
AUXILIARY ENCODER CONNECTOR: P3*	9-pin female D-sub
I/O CONNECTOR: P4*	44-pin high density female D-sub
COMMUNICATIONS INTERFACE (CAN): P5*	9-pin male D-sub
SIZE	8.855 x 4.212 x 1.1 inches 224.92 x 106.98 x 27.94 mm
WEIGHT	

* Mating connectors are not included.

PIN FUNCTIONS:

P1 - Motor and Power Connector:

CONNECTOR	PIN	NAME	DESCRIPTION	I/O
P1	1	GNDSGN	Logic signal ground	GNDSGN
	2	VLS	Logic supply voltage	I
	3	MOTOR A	Motor phase A	O
	4	MOTOR B	Motor phase B	O
	5	MOTOR C	Motor phase C	O
	6	POWER GND	Power ground. Internally connected to GNDSGN	GNDPWR
	7	HIGH VOLTAGE	DC power input	I

P2 - Motor Feedback Connector:

CONNECTOR	PIN	NAME	DESCRIPTION	I/O
P2	1	MOT ENC A+	Differential Encoder Input	I
	2	MOT ENC A-		I
	3	MOT ENC B+	Differential Encoder Input	I
	4	MOT ENC B-		I
	5	GNDSGN	Signal ground	GNDSGN
	6	Hall A	Commutation sensor inputs. Internal 2K pull-up to +5VDC.	I
	7	Hall B		I
	8	Hall C		I
	9	-	Not connected	
	10	-	Not connected	
	11	MOT ENC I+	Differential Encoder Input	I
	12	MOT ENC I-		I
	13	+5V OUT	+5V @ 400mA max. Short-circuit protected.	O
	14	MOTOR OVER TEMP	TTL input	I
	15	SHIELD	Motor feedback cable shield. Internally connected to GNDSGN	SHLD

P3 – Auxiliary Encoder Connector:

CONNECTOR	PIN	NAME	DESCRIPTION	I/O
P3	1	+AUX A / +STEP / +CW	Auxiliary encoder input Step and direction interface Clockwise/counterclockwise interface	I
	2	-AUX A / -STEP / -CW		I
	3	+AUX B / +DIR / +CCW		I
	4	-AUX B / -DIR / -CCW		I
	5	GNDSGN	Signal ground	GNDSGN

6	+5V OUT	+5V @ 400mA max. Short-circuit protected.	O
7	+AUX I	Auxiliary encoder index channel	I
8	-AUX I		I
9	SHIELD	Cable shield. Internally connected to GNDSGN	SHLD

P4 – I/O Connector:

CONNECTOR	PIN	NAME	DESCRIPTION	I/O
P4	1	-	Reserved	
	2	+24V IN	+24V input pull-up (for sourcing inputs option only)	I
	3	PROG INPUT 2	Programmable digital input. Opto-isolated. See schematic below.	I
	4	PROG INPUT 4		I
	5	PROG INPUT 6		I
	6	DRIVE ENABLE	Drive enable input. Opto-isolated. See schematic below.	I
	7	PROG OUTPUT 1	Programmable digital output. Opto-isolated. See schematic below.	O
	8	PROG OUTPUT 3		O
	9	PROG OUTPUT 5		O
	10	GNDIO	Isolated ground	GNDIO
	11	+PROG ANALOG INPUT 1	Programmable analog input. Opto-isolated. See schematic below.	I
	12	+PROG ANALOG INPUT 2		I
	13	+PROG ANALOG INPUT 3		I
	14	SYSTEM RESET	TTL input. Pull to ground to reset drive (same as power cycle). Referenced to GNDSGN.	I
	15	SHIELD	Cable shield. Internally connected to GNDSGN	SHLD
	16	-	Reserved	
	17	+24V IN	+24V input pull-up (for sourcing inputs option only)	I
	18	PROG INPUT 1	Programmable digital input. Opto-isolated. See schematic below.	I
	19	PROG INPUT 3		I
	20	PROG INPUT 5		I
	21	PROG INPUT 7		I
	22	FAULT RESET	Fault reset input. Opto-isolated. See schematic below.	I
	23	PROG OUTPUT 2	Programmable digital output. Opto-isolated. See schematic below.	O
	24	PROG OUTPUT 4		O
	25	PROG OUTPUT 6		O
	26	-	Not connected	
	27	-PROG ANALOG INPUT 1	See pin 11, 12, 13 above	I

	28	-PROG ANALOG INPUT 2		I
	29	-PROG ANALOG INPUT 3		I
	30	GNDSGN	Signal ground	GNDSGN
	31	-	Reserved	
	32	-	Reserved	
	33	POSITIVE LIMIT SWITCH	Positive limit switch input. Opto-isolated. See schematic below.	I
	34	NEGATIVE LIMIT SWITCH	Negative limit switch input. Opto-isolated. See schematic below.	I
	35	HOME SWITCH	Home switch input. Opto-isolated. See schematic below.	I
	36	DRIVE READY	Drive ready output. Opto-isolated. See schematic below.	O
	37	PROG OUTPUT 7	Programmable digital output. Opto-isolated. See schematic below.	O
	38	PROG OUTPUT 8		O
	39	GNDIO	Isolated ground	GNDIO
	40	GNDIO	Isolated ground	GNDIO
	41	-	Not connected	
	42	GNDA	Analog signal ground. Internally connected to GNDSGN	GNDA
	43	PROG ANALOG OUTPUT 1	Programmable analog output. See schematic below.	O
44	-	Not connected		

I/O SCHEMATICS:

- Isolated Outputs

DRIVE READY, PROGRAMMABLE OUTPUT 1...8

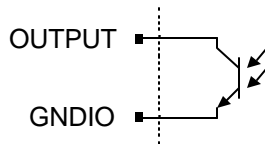

Active maximum voltage	+0.7 VDC
Active maximum current	200 mA
Inactive maximum voltage	+30 VDC
Inactive maximum current	0.01 mA

- Isolated Inputs

DRIVE ENABLE, FAULT RESET, HOME SWITCH, POSITIVE LIMIT SWITCH, NEGATIVE LIMIT SWITCH, PROGRAMMABLE INPUT 1...7

- Sinking Inputs (standard version)

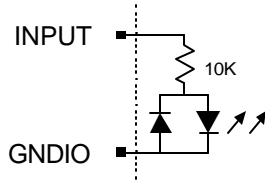

Active maximum voltage	+30 VDC
Active minimum voltage	+18 VDC
Inactive maximum voltage	+2.5 VDC
Inactive minimum voltage	-5VDC

- Sourcing Inputs (optional -SRC version)

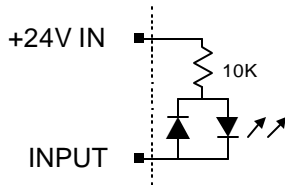

Active maximum voltage	+10VDC
Active minimum voltage	-5VDC
Inactive maximum voltage	+24VIN + 5VDC
Inactive minimum voltage	+24VIN -2.5VDC

- Programmable Analog Output

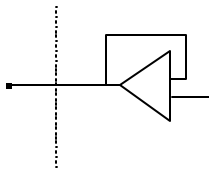

Voltage Range	-10V...+10V
Resolution	10-bit
Minimum Load Resistance	2K Ohm

- Programmable Analog Inputs

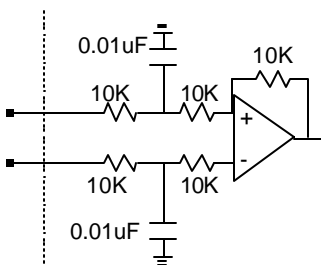

Voltage Range	10V...+10V
Resolution	12-bit

- System Reset Input

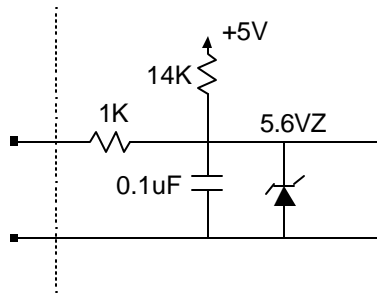

P5 - Communications Interface (CAN):

CONNECTOR	PIN	NAME	DESCRIPTION	I/O
P5	2	CAN_L	CAN _L bus line (dominant low)	I
	3	CAN_GND	CAN ground	GND
	5	CAN_SHLD	CAN shield	SHLD
	7	CAN_H	CAN_H bus line (dominant high)	I
	8	CAN_TERM	Termination. Connect to CAN_H for CAN bus termination (120 Ohm)	GND
	9	CAN_V+	CAN external supply 7.5...13 VDC	I

DIP SWITCH FUNCTIONS:

- CAN Address Setting (factory default is 1)

Node-ID	SW1	SW2	SW3	SW4	SW5	SW6
Via CAN	OFF	OFF	OFF	OFF	OFF	OFF
1	ON	OFF	OFF	OFF	OFF	OFF
2	OFF	ON	OFF	OFF	OFF	OFF
3	ON	ON	OFF	OFF	OFF	OFF
...						
63	ON	ON	ON	ON	ON	ON

- CAN Bus Bit Rate Setting (factory default is 1000K)

Bit Rate (bits/sec)	SW7	SW8
Via CAN	OFF	OFF
500K	OFF	ON
250K	ON	OFF

125K	ON	ON
------	----	----

• CAN Bus Termination

SW10 can be used for CAN bus termination. Setting SW10 ON will internally connect the CAN_H signal to CAN_L via a 120Ω resistor. This can be used if the drive is the last node in a CAN network. Setting SW10 OFF will open this termination. Note: the CAN_TERM pin can also be used for termination, see below.

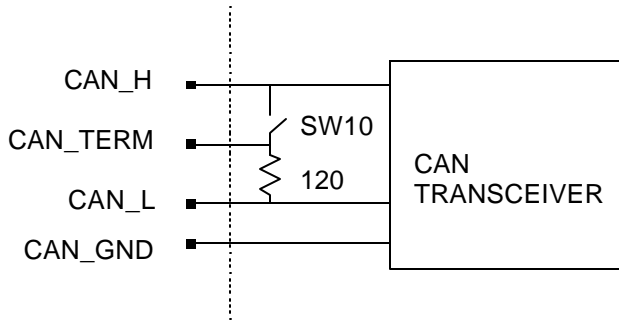

DIGIFLEX® DRIVEWARE:

DigiFlex® DriveWare is a Windows® based application that can be used to setup and configure the DigiFlex® series of digital servo drives via the CAN interface. This application operates with the following PC-to-CAN interfaces:

Manufacturer	Part Number	Style	Manufacturer Contact Information
Advantech	PCL-841	ISA-bus	www.advantech.com
IXXAT	any	any	www.ixxat.com
Kvaser	any	any	www.kvaser.com
Vector	Any	Any	www.vector-cantech.com
ESD Electronics	any	any	www.esd-electronics.com

CANopen OBJECT DICTIONARY:

For more detailed information on CANopen, please visit <http://www.can-cia.org/>, the official web site of CAN in Automation (CiA), the governing body of the CANopen standard.

I. Communication Profile Objects (DS301):

- | | |
|-------------------------------------------------------------|-------------------------------------------------------------|
| 1000h: Device_Type | 1415h: 22 nd receive pdo communication parameter |
| 1001h: Error_register | 1416h: 23 rd receive pdo communication parameter |
| 1002h: Manufacturer_Status_Register | 1417h: 24 th receive pdo communication parameter |
| 1008h: Manufacturer_Device_Name | 1600h: 1 st receive pdo mapping parameter |
| 1009h: Manufacturer_Hardware_Version | 1601h: 2 nd receive pdo mapping parameter |
| 100Ah: Manufacturer_Software_Version | 1602h: 3 rd receive pdo mapping parameter |
| 100Ch: guard-time | 1603h: 4 th receive pdo mapping parameter |
| 100Dh: life-time factor | 1604h: 5 th receive pdo mapping parameter |
| 1010h: store_parameters | 1614h: 21 st receive pdo mapping parameter |
| 1400h: 1 st receive pdo communication parameter | 1615h: 22 nd receive pdo mapping parameter |
| 1401h: 2 nd receive pdo communication parameter | 1616h: 23 rd receive pdo mapping parameter |
| 1402h: 3 rd receive pdo communication parameter | 1617h: 24 th receive pdo mapping parameter |
| 1403h: 4 th receive pdo communication parameter | 1800h: 1 st transmit pdo communication parameter |
| 1404h: 5 th receive pdo communication parameter | 1802h: 3 rd transmit pdo communication parameter |
| 1414h: 21 st receive pdo communication parameter | 1803h: 4 th transmit pdo communication parameter |

1804h: 5th transmit pdo communication parameter
 1814h: 21st transmit pdo communication parameter
 1815h: 22nd transmit pdo communication parameter
 1816h: 23rd transmit pdo communication parameter
 1817h: 24th transmit pdo communication parameter
 1818h: 25th transmit pdo communication parameter
 1819h: 26th transmit pdo communication parameter
 1A00h: 1st transmit pdo mapping parameter
 1A02h: 3rd transmit pdo mapping parameter
 1A03h: 4th transmit pdo mapping parameter
 1A04h: 5th transmit pdo mapping parameter
 1A14h: 21st transmit pdo mapping parameter
 1A15h: 22nd transmit pdo mapping parameter
 1A16h: 23rd transmit pdo mapping parameter
 1A17h: 24th transmit pdo mapping parameter
 1A18h: 25th transmit pdo mapping parameter
 1A19h: 26th transmit pdo mapping parameter

II. Drive Profile Objects (DSP402)

- Common Objects

6402h: motor_type
 6403h: motor_catalogue_number
 6404h: motor_manufacturer
 6410h: motor_data
 6510h: drive_data
 6502h: supported_drive_modes
 6503h: drive_catalogue_number
 6504h: drive_manufacturer

 2001h: user_defined_drive_name
 2002h: user_units
 200Eh: active_non_fatal_errors
 200Fh: error_self_reset
 2011h: commutation_sensor_selection_code
 2012h: hall_sensor_parameters
 201Fh: hall_sensor_error_option_code
 2031h: hall_sensor_error_counter
 2032h: hall_sensor_error_counter_limit
 2013h: encoder_parameters
 2020h: encoder_counter
 2021h: encoder_position
 2022h: encoder_index_counter
 2027h: encoder_error_option_code
 2023h: encoder_error_counter
 2024h: encoder_error_counter_limit
 2014h: auxiliary_encoder_parameters
 2028h: auxiliary_encoder_counter
 2029h: auxiliary_encoder_position
 202Ah: auxiliary_encoder_index_counter
 2030h: auxiliary_encoder_error_option_code
 202Bh: auxiliary_encoder_error_counter
 202Ch: auxiliary_encoder_error_counter_limit
 2040h: DIP-switch_settings
 20A0h: programmable_digital_inputs

20A1h: programmable_digital_outputs
 20A2h : programmable_analog_inputs
 20A3h: programmable_analog_outputs
 20A4h: programmable_digital_inputs_polarity
 20A5h: programmable_digital_inputs_function
 20A8h: programmable_digital_outputs_polarity
 20A9h: programmable_digital_outputs_function
 20ACh : programmable_analog_input_parameters
 20AEh: programmable_analog_output_parameters
 20C2h: power_stage_temperature
 20C8h: communication_control
 208Fh: load_inertia

- Device Control Objects

6040h: controlword
 20C4h: controlword_initial_value
 20C5h: auxiliary_controlword
 6041h: statusword
 605Ah: quick_stop_option_code
 605Bh: shutdown_option_code
 605Ch: disable_operation_option_code
 6060h: modes_of_operation
 6061h: modes_of_operation_display
 2000h: statusword_1
 2004h: dedicated_digital_inputs
 2005h: dedicated_digital_outputs
 2006h: dedicated_digital_inputs_polarity
 2007h: dedicated_digital_outputs_polarity
 2049h: invert_command
 20B0h: trigger_at_value
 20B1h: capture_value
 20B3h: trigger_signal
 20B5h: capture_signal
 20B6h: capture_event
 20C1h: delay_times
 20C3h: motor_overnight_temperature_option_code

- Factor Group Objects

6090h: velocity_encoder_resolution
 608Fh: position_encoder_resolution
 6093h: position_factor
 6094h: velocity_encoder_factor
 6097h: acceleration_factor
 2079h: analog_torque_command_factor
 207Ah: digital_torque_command_factor
 2081h: analog_velocity_command_factor
 2082h: digital_velocity_command_factor
 2091h: analog_position_command_factor
 2092h: digital_position_command_factor

- Profile Position Mode Objects

607Ah: target_position
 607Dh: software_position_limit

6086h: motion_profile_type
 607Fh: maximum_profile_velocity
 6081h: profile_velocity
 6083h: profile_acceleration
 6084h: profile_deceleration
 6085h: Quick_stop_deceleration

- Homing Mode Objects

607Ch: home_offset
 6098h: homing_method
 6099h: homing_speeds
 609Ah: homing_acceleration

- Position Control Function Objects

6062h: position_demand_value
 6063h: position_actual_value*
 6064h: position_actual_value
 6067h: position_window
 6068h: position_window_time
 6065h: following_error_window
 6066h: following_error_time_out
 60F4h: following_error_actual_value
 60FBh: position_control_parameter_set
 60FCh: position_demand_value*
 2090h: demand_position_offset
 2093h: position_command_low_pass_filter

- Profile Velocity Mode Objects

6069h: velocity_sensor_actual_value
 606Ah: sensor_selection_code
 606Bh: velocity_demand_value

ORDERING INFORMATION:

Standard model: DX15CO8X

With sourcing inputs: DX15CO8X-SRC

X indicates the current revision letter.

606Ch: velocity_actual_value
 606Dh: velocity_window
 606Eh: velocity_window_time
 606Fh: velocity_threshold
 6070h: velocity_threshold_time
 60F9h: velocity_control_parameter_set
 60FFh: target_velocity
 2080h: demand_velocity_offset
 2083h: velocity_command_low_pass_filter
 2084h: velocity_error

- Profile Torque Mode Objects

6071h: target_torque
 6072h: max_torque
 6074h: torque_demand_value
 6075h: motor_rated_current
 6076h: motor_rated_torque
 6077h: torque_actual_value
 6078h: current_actual_value
 6079h: dc_link_circuit_voltage
 6087h: torque_slope
 6088h: torque_profile_type
 60F8h: torque_control_parameters
 2010h: rated_voltage
 2070h: current_control_parameter_set
 2074h: target_current_q
 2075h: reference_current_q
 2077h: reference_torque
 2078h: rated_torque_constant
 207Bh: Torque command low pass filter

MOUNTING DIMENSIONS:

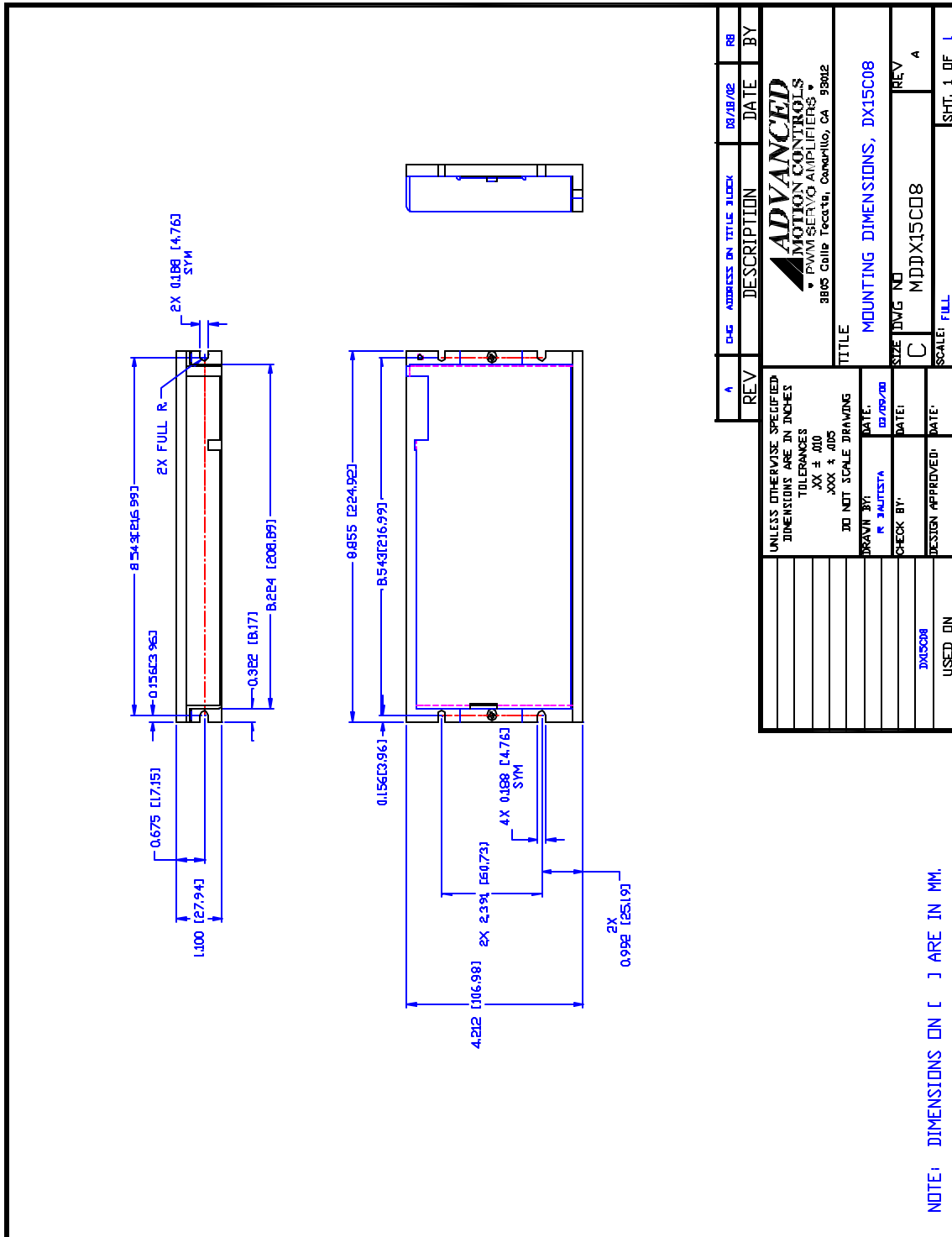

REV	DESCRIPTION	DATE	BY
A	DWG ADDRESS ON TITLE BLOCK	08/18/02	RB

UNLESS OTHERWISE SPECIFIED DIMENSIONS ARE IN INCHES TOLERANCES XX ± .00 .XXX ± .005	
DO NOT SCALE DRAWING	
DRAWN BY: R. RAJASTE	DATE: 08/09/02
CHECK BY:	DATE:
DESIGN APPROVED:	DATE:
USED ON DX15CO8	

ADVANCED MOTION CONTROLS P.W.M. SERV/O AMPLIFIERS 3805 Calle Tecate, Camarillo, CA 93002	
TITLE MOUNTING DIMENSIONS, DX15CO8	
SIZE C	DWG NO. MDDX15CO8
SCALE FULL	REV A
SHT. 1 OF 1	



Artisan Technology Group is your source for quality new and certified-used/pre-owned equipment

- FAST SHIPPING AND DELIVERY
- TENS OF THOUSANDS OF IN-STOCK ITEMS
- EQUIPMENT DEMOS
- HUNDREDS OF MANUFACTURERS SUPPORTED
- LEASING/MONTHLY RENTALS
- ITAR CERTIFIED SECURE ASSET SOLUTIONS

SERVICE CENTER REPAIRS

Experienced engineers and technicians on staff at our full-service, in-house repair center

*InstraView*SM REMOTE INSPECTION

Remotely inspect equipment before purchasing with our interactive website at www.instraview.com ↗

WE BUY USED EQUIPMENT

Sell your excess, underutilized, and idle used equipment. We also offer credit for buy-backs and trade-ins. www.artisanng.com/WeBuyEquipment ↗

LOOKING FOR MORE INFORMATION?

Visit us on the web at www.artisanng.com ↗ for more information on price quotations, drivers, technical specifications, manuals, and documentation

Contact us: (888) 88-SOURCE | sales@artisanng.com | www.artisanng.com