



Artisan Technology Group is your source for quality new and certified-used/pre-owned equipment

- FAST SHIPPING AND DELIVERY
- TENS OF THOUSANDS OF IN-STOCK ITEMS
- EQUIPMENT DEMOS
- HUNDREDS OF MANUFACTURERS SUPPORTED
- LEASING/MONTHLY RENTALS
- ITAR CERTIFIED SECURE ASSET SOLUTIONS

SERVICE CENTER REPAIRS

Experienced engineers and technicians on staff at our full-service, in-house repair center

*InstraView*SM REMOTE INSPECTION

Remotely inspect equipment before purchasing with our interactive website at www.instraview.com ↗

WE BUY USED EQUIPMENT

Sell your excess, underutilized, and idle used equipment. We also offer credit for buy-backs and trade-ins. www.artisanng.com/WeBuyEquipment ↗

LOOKING FOR MORE INFORMATION?

Visit us on the web at www.artisanng.com ↗ for more information on price quotations, drivers, technical specifications, manuals, and documentation

Contact us: (888) 88-SOURCE | sales@artisanng.com | www.artisanng.com

REV	DATE
B	28APR89

3300/15

DUAL VIBRATION

MONITOR

OPERATION MANUAL

BENTLY
NEVADA

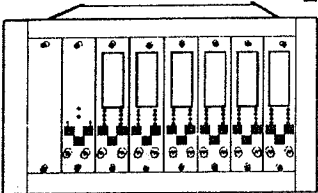

NOTICE

READ THE FOLLOWING BEFORE INSTALLING OR OPERATING EQUIPMENT.

Bently Nevada Corporation has attempted to identify areas of risk created by improper installation and/or operation of this product. These areas of information are noted as WARNING or CAUTION for your protection and for the safe and effective operation of this equipment. Read all instructions before installing or operating this product. Pay particular attention to those areas designated by the following symbols.

 WARNING
High voltage present could cause shock burns or death
Do not touch exposed wires or terminals

CAUTION
Machine Protection Could Be Discontinued

IN THIS DOCUMENT PROCEDURES ARE GIVEN ONLY FOR CHANNEL A. PROCEDURES FOR CHANNEL B ARE SIMILAR EXCEPT FOR THE OBVIOUS SUBSTITUTION OF CORRESPONDING SWITCHES, TERMINALS, AND INDICATORS.

SYMBOLS

Special symbols are used in the manual to illustrate specifics in the step-by-step process. For example:



PRESS

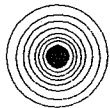

FLASHING

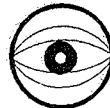

OBSERVE

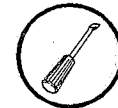

SCREWDRIVER

FOREWORD

This document is for control room personnel who operate the 3300 Monitoring System. The procedures are presented in step-by-step graphic format.

RELATED DOCUMENTS

- 3300 System Overview, 80171
- 3300 System Installation Instructions, 80172
- 3300 System Troubleshooting, 80173
- 3300 Power Supply, 80174
- 3300 System Monitor, 80175
- 3300 Dual Vibration Monitor Maintenance , 80177-01
- Dynamic Data Manager System, 46390-01

Keyphasor® is a registered trademark of Bently Nevada Corporation

Proximito® is a registered trademark of Bently Nevada Corporation

Document No. 80176 • First Printing: January 1988

Copyright © 1987 Bently Nevada Corporation

All Rights Reserved

No part of this publication may be reproduced, transmitted, stored in a retrieval system nor translated into any human or computer language, in any form or by any means, electronic, mechanical, magnetic, optical, chemical, manual, or otherwise, without the prior written permission of the copyright owner,

Bently Nevada Corporation
P.O. Box 157
Minden, Nevada 89423 USA
Telephone : 702-782-3611
Telex: 7400983 BNC UC
Fax: 702-782-9253

**Copyright infringement is a serious matter under
United States of America and Foreign Copyright Laws**

Blank Page

CONTENTS

TITLE	SECTION
DUAL VIBRATION MONITOR SYSTEM	1
MONITOR FUNCTIONS	2
MONITOR OPTIONS	3
PROGRAMMABLE OPTIONS	4
OK	5
BYPASS	6
ALERT	7
DANGER	8
MONITOR RANGES	9
READ CHANNEL VIBRATION	10
READ GAP VOLTAGE	11
READ ALERT SETPOINT LEVELS	12
READ DANGER SETPOINT LEVELS	13
SELF TEST	14

Blank Page

1 DUAL VIBRATION MONITOR SYSTEM

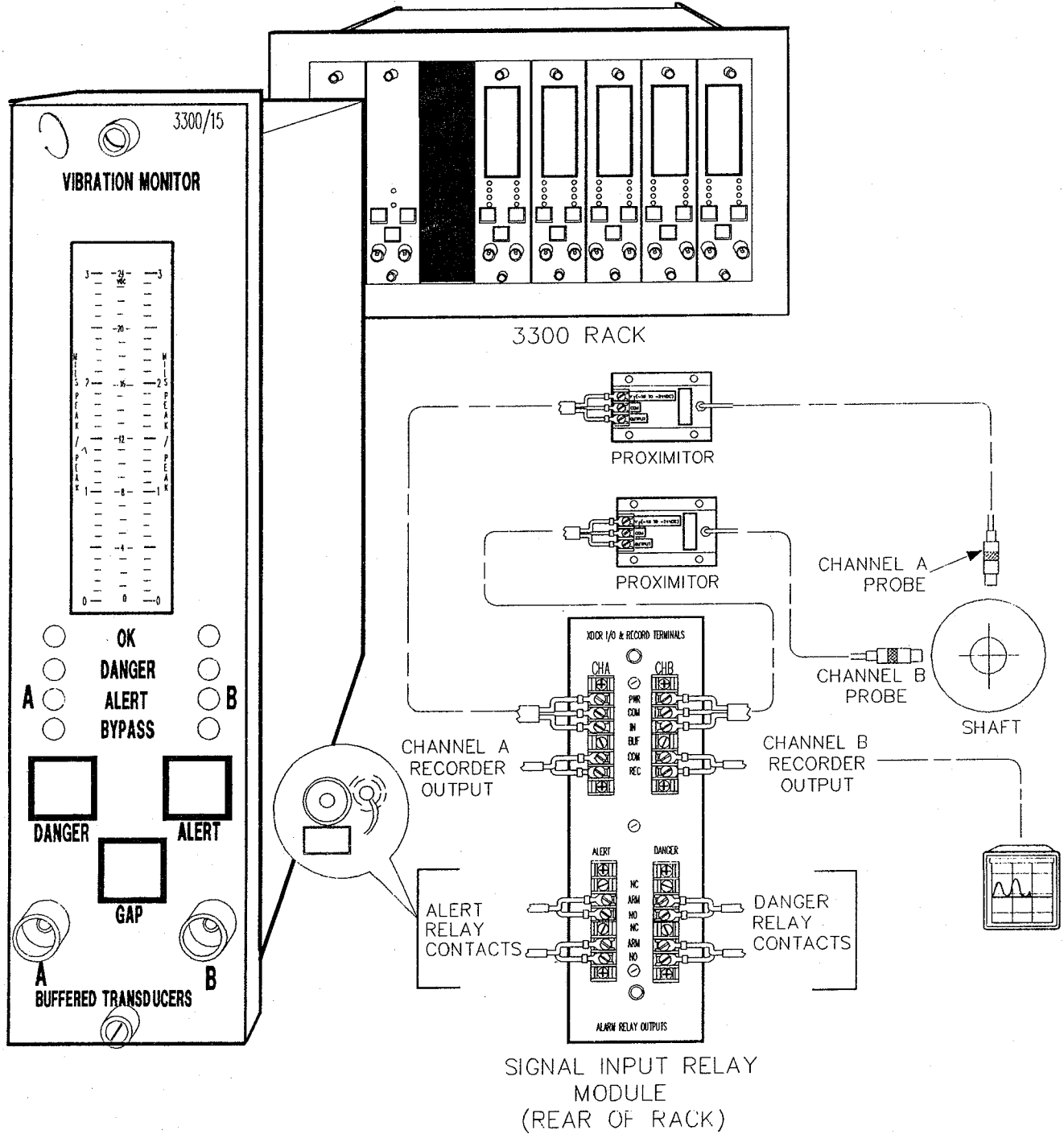

2

MONITOR FUNCTIONS

RADIAL VIBRATION - Radial vibration is defined as shaft dynamic motion in a direction perpendicular to the shaft centerline. The Dual Vibration Monitor displays vibration values for two channels (Channels A and B).

PROBE GAP VOLTAGE - Probe gap is measured as a negative dc voltage that is directly proportional to the gap distance between the face of a proximity probe and the surface being monitored. Probe gap voltage for each channel is displayed on the front panel meter by pressing the GAP switch.

OK - When the Proximity output voltage is within its upper/lower OK voltage limits, the transducer is defined as OK. The OK detection circuit controls the channel OK LED and the monitor relay drive to the OK relay.

OK RELAY - The OK Relay is located on the Power Input Module. Every channel in the rack must be OK or bypassed to energize the OK Relay.

TIMED OK/CHANNEL DEFEAT - Timed OK/Channel Defeat minimizes faulty transducer wiring from causing false alarms. If the probe input signal level on a given channel is not within upper/lower limits, that channel OK LED goes off, the BYPASS LED goes on, the channel is disabled, and the OK Relay deenergizes. If the channel input signal level is restored within the upper/lower OK limits for 30 seconds, the channel OK LED will start flashing at 1 Hz to indicate the OK state is restored, the BYPASS LED goes off, and monitoring is enabled. The RESET switch on the front panel of the System Monitor must be pressed to stop the OK LED from flashing (it remains on). If the channel remains in the NOT OK state, a Channel Bypass switch on the monitor circuit board can be set to put the channel "out of service". The monitor can then be operated as a single-channel monitor. Without this feature, the OK Relay could not be reactivated. In the Timed OK/Defeat and Channel Bypass modes, there is no recorder output and the meter registers zero.

ALARM - Pressing the ALERT or DANGER switch on the front panel of the monitor causes the corresponding Alert (first-level alarm) or Danger (second-level alarm) alarm setpoints on each channel to be displayed on the front panel meter. ALERT and DANGER LEDs light when the vibration signal level exceeds preset levels for the selected time delay, and appropriate Alert and Danger alarm relay contacts are activated. Voting logic options determine when the Danger alarm relay contacts are activated.

FIRST OUT - Separate First Out circuits exist for Alert and Danger alarms. A monitor with First Out option selected flashes a channel alarm LED if that channel was the first channel in the rack to go into alarm. Pressing the RESET switch acknowledges the First Out condition. This allows the next channel in the rack that goes from non-alarm-to-alarm condition to indicate First Out by flashing its alarm LED.

ALARM RELAYS - Monitor alarms can be programmed for either latching or nonlatching mode. In the nonlatching mode, the alarm resets automatically when the alarm no longer exists. In the latching mode, the alarm condition must be reset manually by pressing the RESET switch on the front panel of the System Monitor (or by closing external Reset contacts). The alarm will not reset if the alarm condition still exists.

DANGER BYPASS - For maintenance functions, a DANGER BYPASS switch on the monitor circuit board is set to inhibit the Danger relay drive. This function turns on the BYPASS LEDs. Other front panel functions are not effected. This function can be disabled using a jumper within the monitor.

BUFFERED OUTPUT - The Channels A and B coaxial cable connectors on the front panel of the monitor and terminals on the Signal Input Relay Module provide buffered signals from the respective channel transducers. These connectors can be used for connection of external equipment.

TRIP MULTIPLY - The Trip Multiply function multiplies set points by 2X or 3X in response to an external contact closure through terminals on the Power Input Module. The front panel meter and recorder outputs could saturate in this mode.

RECORDER OUTPUTS - Depending on the option selected, the recorder output levels proportional to measured vibration are either 0 to -10 Vdc, +1 to +5 Vdc, or +4 to +20 mA.

SELF TEST - The monitor has three categories of self test: cyclic, power up, and user invoked.

- Power up self test is performed automatically each time the monitor power is turned on. A series of basic tests and transducer OK tests are performed. Upon completion of the tests, if no errors, the monitor will perform timed OK channel defeat and monitoring will resume in 30 seconds.
- Cyclic self tests is performed automatically during monitor operation. Errors encountered during cyclic tests disable the monitor, and flash a led bargraph error code. Should the error be intermittent the monitor will return to operation, but the error codes are stored for retrieval during user-invoked self tests. Stored error codes are indicated by OK LED's flashing at 5 HZ provided that the channel is OK
- User invoked test performs power up self test and allows error messages stored during cyclic tests to be read and cleared. stored errors are announced by flashing the OK LEDs at 5 HZ and displaying the error codes on the front panel LCD bargraph.

3 MONITOR OPTIONS

DUAL VIBRATION MONITOR

PART NUMBER
3300/15

FULL SCALE RANGE
AA 01

TRANSDUCER INPUT
BB 01

ALARM RELAY
CC 00

APPROVALS
DD 00

BARRIERS USED
EE 00

TRIP MULTIPLY
FF 00

01=0-3 MILS pk-pk
02=0-5 MILS pk-pk
03=0-10 MILS pk-pk
04=0-15 MILS pk-pk
05=0-20 MILS pk-pk
11=0-100 MICROMETRES pk-pk
12=0-150 MICROMETRES pk-pk
13=0-200 MICROMETRES pk-pk
14=0-400 MICROMETRES pk-pk
15=0-500 MICROMETRES pk-pk

01=7200 PROXIMITOR
200 mV/MIL
02=3000 PROXIMITOR
200 mV/MIL (MUST
BE USED WITH POWER
SUPPLY PROGRAMMED
TO -18Vdc)

00=NONE
01=5A EPOXY
SEALED
02=5A HERMETI-
CALLY SEALED
03=QUAD RELAYS
EPOXY SEALED

00=NONE
01=CSA
02=BASEEFA
03=CITY OF LA

00=NO
01=YES

00=NONE
01=2X TRIP MULTIPLY
02=3X TRIP MULTIPLY

4 PROGRAMMABLE OPTIONS

PROGRAMMABLE OPTIONS

FIRST OUT	<input type="radio"/> ENABLED* <input type="radio"/> DISABLED
ALARM DELAYS	<input type="radio"/> .1 SECOND <input type="radio"/> 1 SECOND <input type="radio"/> 3 SECONDS* <input type="radio"/> 6 SECONDS
FREQUENCY RESPONSE	<input type="radio"/> 240-240,000 RPM* <input type="radio"/> 60-36,000 RPM
ALERT MODE	<input type="radio"/> LATCHING* <input type="radio"/> NON-LATCHING

DANGER MODE	<input type="radio"/> LATCHING* <input type="radio"/> NON-LATCHING
RECORDER OUTPUTS	<input type="radio"/> +4 TO +20 mA* <input type="radio"/> +1 TO +5 Vdc <input type="radio"/> 0 TO -10 Vdc
DANGER VOTING	<input type="radio"/> OR VOTING FOR RELAY DRIVE* <input type="radio"/> AND VOTING FOR RELAY DRIVE
DANGER BYPASS SWITCH	<input type="radio"/> ENABLE <input type="radio"/> DISABLE*

*SHIPPED WITH OPTION INSTALLED

5	OK
----------	-----------

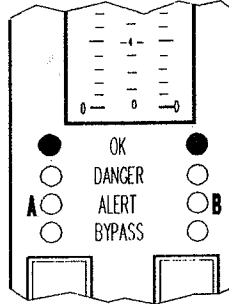

NOTE: EACH CHANNEL IN THE SYSTEM CONTROLS THE OK RELAY. THEREFORE, ANY CHANNEL CAN CAUSE A NOT OK RELAY CONDITION (DEENERGIZED RELAY).

LED DISPLAY	CONDITION	OK RELAY DRIVE*
A B		
● OK ●	CHANNEL A AND B IN OPERATING RANGE.	ON
○ OK ● ----- ● OK ○	RESPECTIVE CHANNEL A OR B TRANSDUCER IN NOT OK CONDITION, OR BYPASSED. *	OFF *
○ OK ○	MONITOR IN SELF TEST, OR BOTH TRANSDUCERS NOT OK OR BY-PASSED.*	OFF *
⊙ OK ⊙	FLASHING AT 5 Hz = ERROR ENCOUNTERED DURING CYCLIC TEST. READ ERROR MESSAGE. (SEE 14)	ON
⊙ OK ⊙ ----- ⊙ OK ● ----- ● OK ⊙	FLASHING AT 1 Hz = TRANSDUCER HAS BEEN NOT OK SINCE LAST RESET.	ON

*NOT OK CHANNELL CAN BE BYPASSED TO RESTORE RELAY OK CONDITIONS

2S501

6

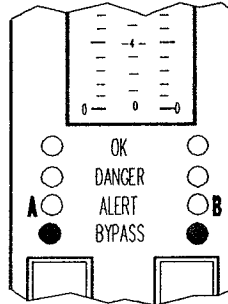

BYPASS

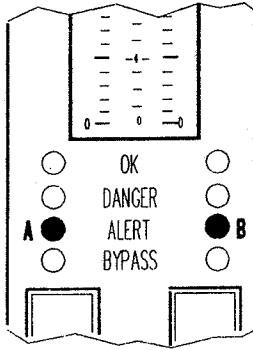

LED DISPLAY		CONDITION
A	B	
●	BYPASS ●	<ul style="list-style-type: none"> ○ MONITOR IN DANGER BYPASS MODE ○ SYSTEM IN POWER UP MODE ○ USER INVOKED SELF TEST IN PROGRESS ○ TIMED OK CHANNEL DEFEAT ○ BOTH CHANNEL BYPASS
○	BYPASS ●	<ul style="list-style-type: none"> ○ CHANNEL A OR B BYPASSED ○ TIMED OK CHANNEL DEFEAT
●	BYPASS ○	
<ul style="list-style-type: none"> ○ BYPASS ○ ○ BYPASS ● ● BYPASS ○ 	<ul style="list-style-type: none"> ○ BYPASS ○ ○ BYPASS ● ● BYPASS ○ 	<p>TRIP MULTIPLY ACTIVATED. FLASHING OVERRIDDEN BY:</p> <ul style="list-style-type: none"> ○ CHANNEL BYPASS ○ TIMED OK CHANNEL DEFEAT ○ DANGER BYPASS

7 ALERT



LED DISPLAY		CONDITION	ALERT RELAY DRIVE
A	B		
●	ALERT ○	EITHER CHANNEL A OR B (OR BOTH) HAS EXCEEDED ALARM LEVEL. (SEE 12)	ON
○	ALERT ●		ON
●	ALERT ●		ON
○	ALERT 	FIRST OUT CONDITION FOR RESPECTIVE A OR B CHANNEL THAT HAS EXCEEDED ALARM LEVEL. TWO CHANNELS MAY INDICATE FIRST OUT FOLLOWING SELF TEST. *	ON
	ALERT ○		ON

*FIRST OUT RESOLUTION IS BETTER THAN 50 MILLISECONDS. IF TWO ALARMS OCCUR WITHIN 50 MILLISECONDS OR LESS, THEY COULD CAUSE BOTH LEDS TO FLASH.

8

DANGER

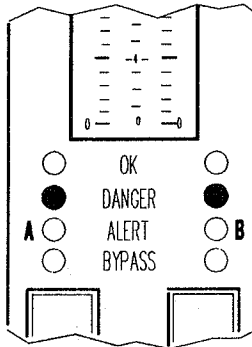

LED DISPLAY A B	CONDITION	DANGER RELAY DRIVE	
		OR VOTING	AND VOTING*
● DANGER ○	EITHER CHANNEL A OR B (OR BOTH) HAS EXCEEDED ALARM LEVEL. (SEE 13)	ON	OFF
○ DANGER ●		ON	OFF
● DANGER ●		ON	ON
○ DANGER (concentric circles)	FIRST OUT CONDITION FOR RESPECTIVE A OR B CHANNEL THAT HAS EXCEEDED ALARM LEVEL. TWO CHANNELS MAY INDICATE FIRST OUT FOLLOWING SELF TEST.**	ON	OFF
(concentric circles) DANGER ○		ON	OFF

*IF EITHER CHANNEL IS BYPASSED, ALARM RELAY IS ACTIVATED IF NONBYPASSED CHANNEL IS IN ALARM.

**FIRST OUT RESOLUTION IS BETTER THAN 50 MILLISECONDS IF TWO ALARMS OCCUR WITHIN 50 MILLISECONDS OR LESS OF EACH OTHER THEY COULD CAUSE BOTH LEDS TO FLASH.

9 MONITOR RANGES



FULL SCALE RANGE	
01=0-3 MILS pk-pk	
02=0-5 MILS pk-pk	
03=0-10 MILS pk-pk	
04=0-15 MILS pk-pk	
05=0-20 MILS pk-pk	
11=0-100 MICROMETRES pk-pk	
12=0-150 MICROMETRES pk-pk	
13=0-200 MICROMETRES pk-pk	
14=0-400 MICROMETRES pk-pk	
15=0-500 MICROMETRES pk-pk	

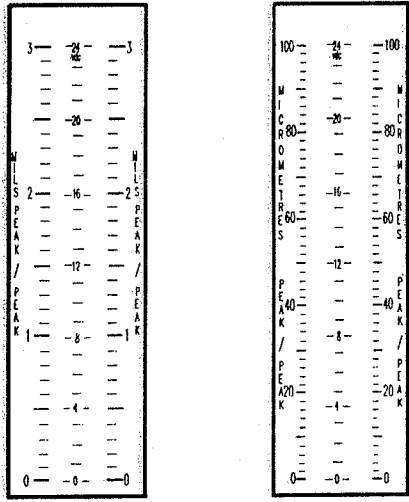

EXAMPLES OF METER SCALES

10

READ CHANNEL VIBRATION

MONITOR CONTINUOUSLY INDICATES MEASURED VIBRATION VALUES FOR CHANNELS A AND B

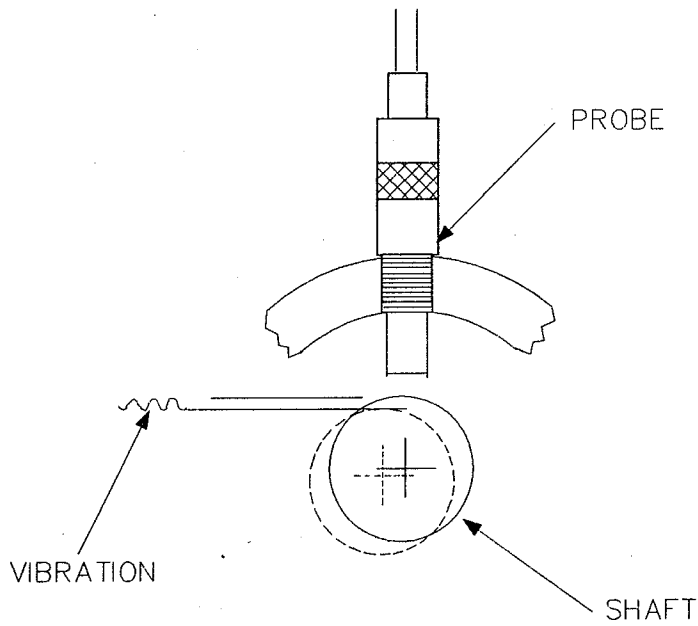
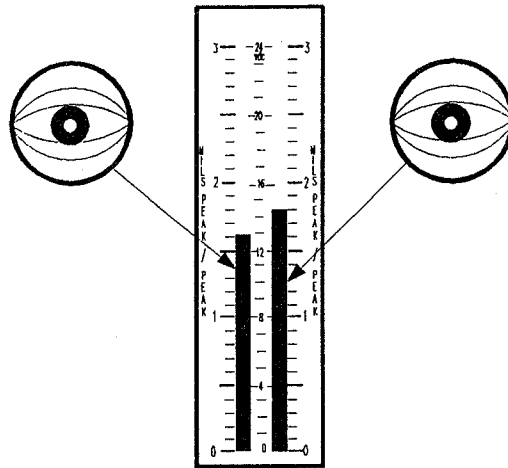

11 READ GAP VOLTAGE

1. PRESS **GAP** SWITCH AND READ GAP VOLTAGE FOR BOTH CHANNEL A AND CHANNEL B ON METER USING CENTER METER SCALE.

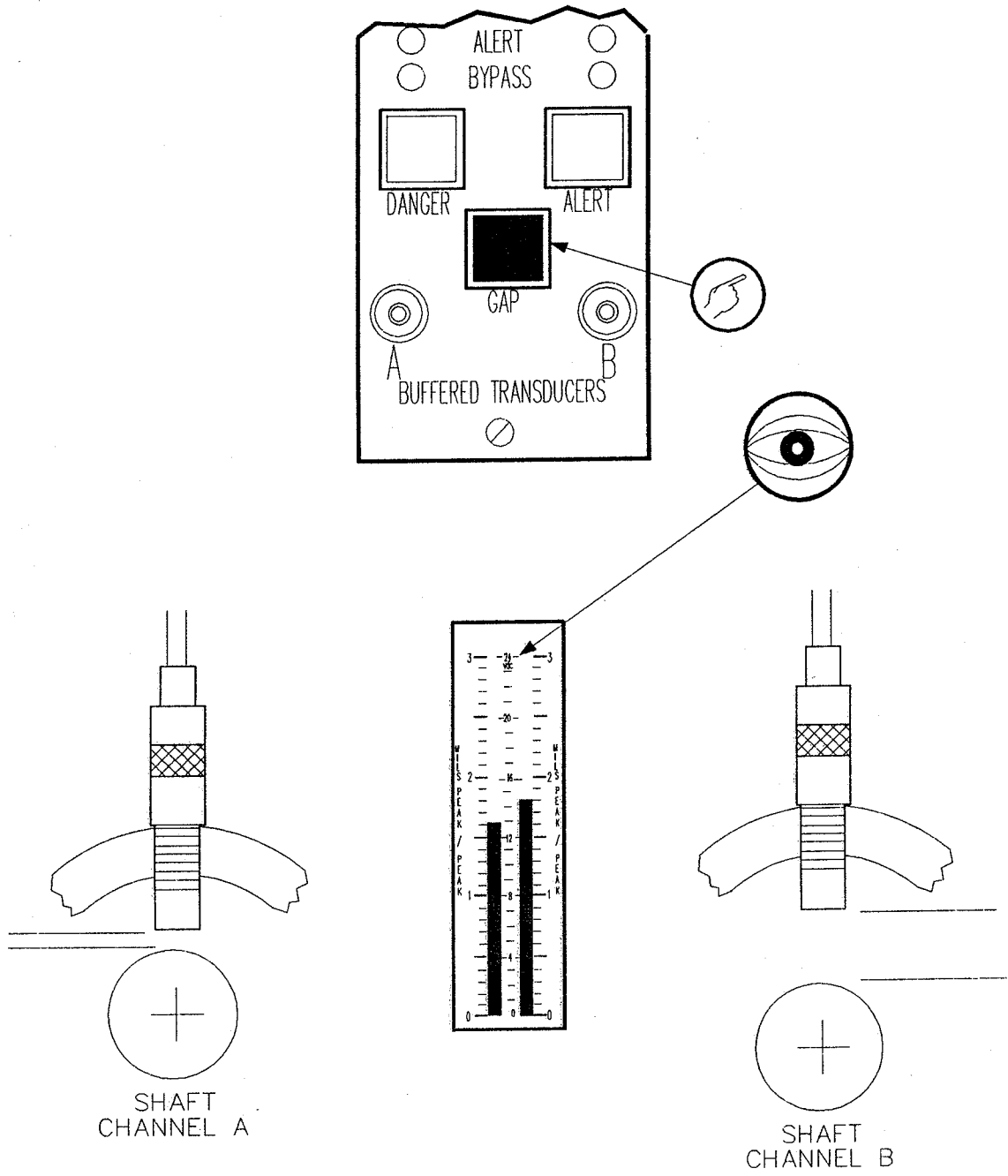

12 READ ALERT SETPOINT LEVELS

1. PRESS **ALERT** SWITCH AND READ ALERT SETPOINTS (FOR BOTH CHANNEL A AND B) ON METER SCALE.

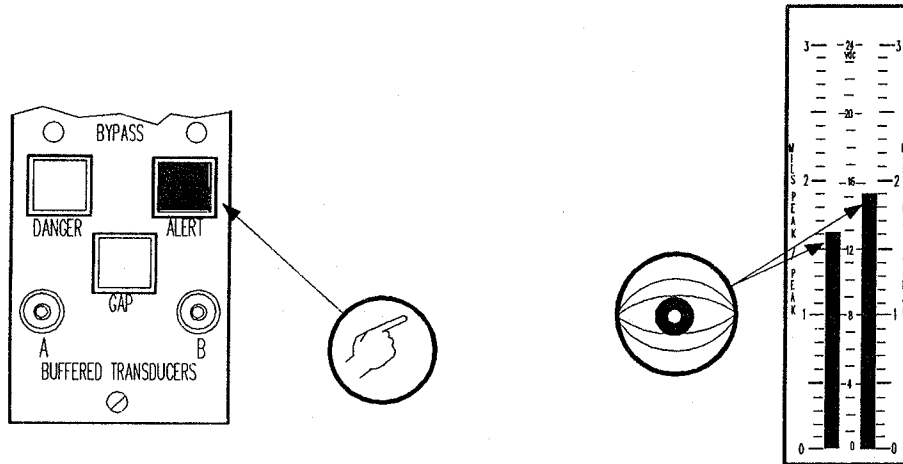

13 READ DANGER SETPOINT LEVELS

1. PRESS **DANGER** SWITCH AND READ DANGER SETPOINTS (FOR BOTH CHANNEL A AND B) ON METER SCALE.

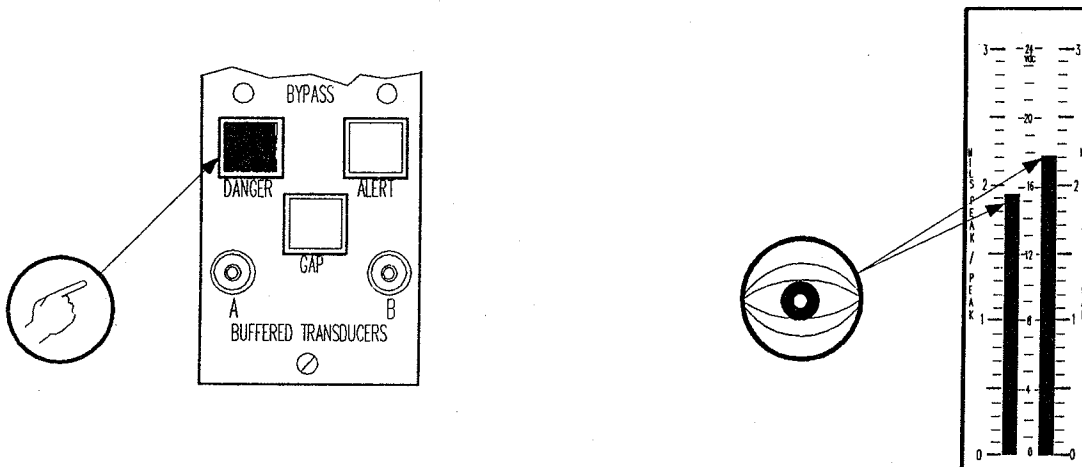

14

SELF TEST

THE MONITOR HAS THREE LEVELS OF SELF TESTS:

- POWER UP TEST: PERFORMED ONLY WHEN MONITOR IS TURNED ON.
- CYCLIC TEST: PERFORMED CONTINUOUSLY.
- USER INVOKED TEST: PERFORMED ONLY WHEN INITIATED BY USER.

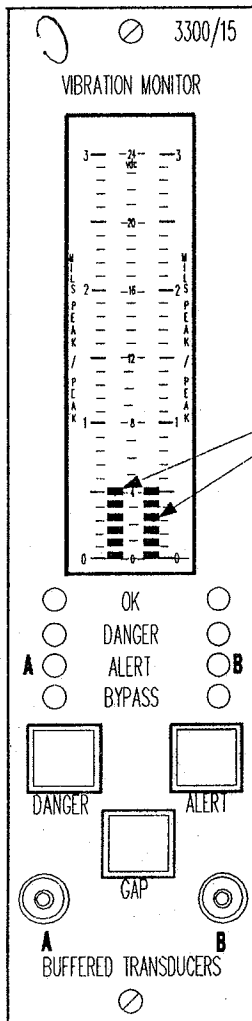

IF ERRORS ARE DETECTED DURING CYCLIC SELF TESTS:

- MONITORING IS ABORTED UNTIL THE ERROR IS RESOLVED.
- ERROR CODE STORED IN MEMORY AND FLASHED ON LCD BARGRAPH DISPLAY.
- **BYPASS** LED GOES ON AND **OK** LED FLASHES AT 5 HZ.
- IF ERROR IS INTERMITTENT AND DISAPPEARS. MONITORING IS RESUMED AND **OK** LED FLASHES AT 5 HZ.
- ERROR CODE STORED. USER INVOKED TEST DISPLAYS AND CLEARS ERROR.

IF ERRORS ARE DETECTED DURING POWER UP TEST OR USER INVOKED TEST:

- MONITORING IS ABORTED UNTIL USER-ACTION RESOLVES PROBLEM.
- TEST CAN BE RERUN WITH MONITOR POWER UP OR USER INVOKED TEST.

14 SELF TEST [CONT]

- o INITIATE USER INVOKED TEST BY SHORTING ACROSS TWO SELF-TEST (ST) PINS.

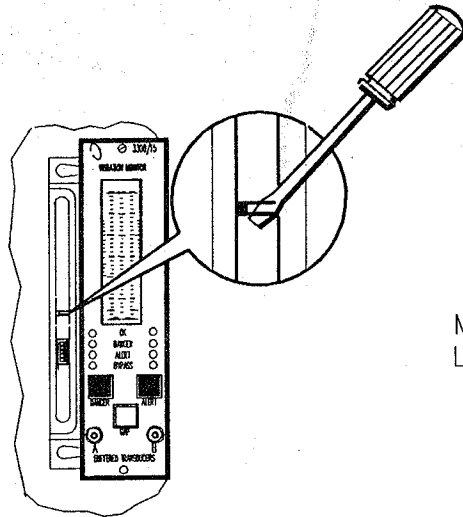

CAUTION

MACHINE PROTECTION WILL BE LOST FOR DURATION OF TEST

- o AT COMPLETION OF USER INVOKED TEST MONITOR WILL RECALL STORED ERROR CODES, IF ANY. THESE ERROR CODES MUST BE READ AND CLEARED WITH USER INTERACTION TO ALLOW MONITORING TO CONTINUE. TIMED OK CHANNEL DEFEAT IS ACTIVE FOR APPROXIMATELY 30 SECONDS FOLLOWING THIS ACTION.

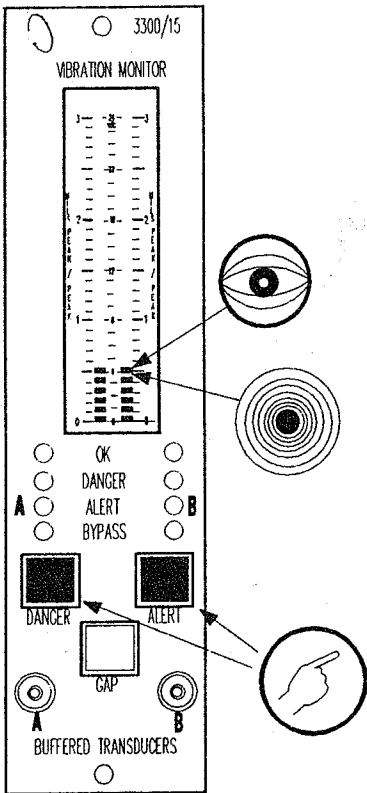

NOTE

ALTHOUGH BOTH COLUMNS ON BARGRAPH FLASH, ERROR CODE IS ONLY THE SUM OF BARGRAPH SEGMENTS DISPLAYED IN ONE COLUMN. EXAMPLE SHOWS ERROR CODE 6.

- o READ CODES ON LIST; STEP THROUGH EACH ERROR CODE ON LIST BY PRESSING AND HOLDING **ALERT** SWITCH FOR APPROXIMATELY 1 SECOND.
- o AT THE END OF LIST, LCD BARGRAPH DISPLAYS ALL SEGMENTS. TO REREAD LIST PRESS **ALERT** SWITCH. TO CLEAR LIST FROM MEMORY, PRESS AND HOLD **DANGER** SWITCH FOR APPROXIMATELY 1 SECOND.

14

SELF TEST [CONT]

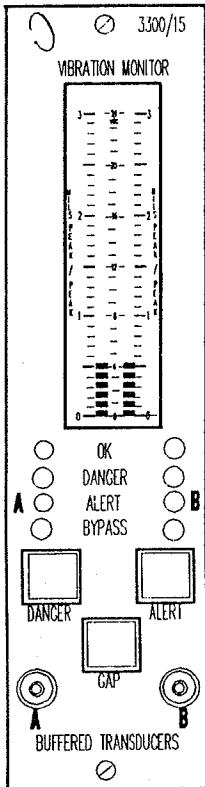

ERROR CODE	DESCRIPTION
2.	ROM CHECKSUM HAS FAILED. *
3.	EEPROM FAILURE NO.1. **
4.	EEPROM FAILURE NO.2; ADJUST SET POINTS. (SEE 12 AND 13) ***
5.	+7.5/-VT NODE OUT OF TOLERANCE. **
6.	+VRH NODE OUT OF TOLERANCE. **
7.	+5V NODE OUT OF TOLERANCE. **
8.	MVREF NODE OUT OF TOLERANCE. **
9.	+7.5V NODE OUT OF TOLERANCE. **
10.	+VRL NODE OUT OF TOLERANCE. **
11.	MVREF/-6.5V NODE OUT OF TOLERANCE. **
12.	+5V/-7.5V NODE OUT OF TOLERANCE. **
13.	SCIC CLOCK FAILURE **
14.	RAM FAILURE. *
15.	IC U4 OUTPUT DISAGREES WITH GAP VOLTAGE VALUE. *

- * TESTED ONLY AT POWER-UP OR USER-INVOKED SELF TEST. ERRORS NOT RECORDED, BUT ERROR CODES DISPLAYED ON FRONT PANEL METER.
- ** TESTED ONLY AT CYCLIC SELF TEST. ERRORS 2, 3, 14, AND 15 ARE NONRECOVERABLE; ERRORS 5 THROUGH 13 COULD BE INTERMITTANT AND RECOVERABLE.
- *** ERROR 4 IS A SET POINT SELF TEST FAILURE. THIS MAY BE CORRECTED BY ADJUSTING ALL SET POINTS IN MONITOR.

INDEX

A	
Alert	6
B	
Bypass	5
D	
Danger	7
Dual Vibration Monitoring System	1
M	
Monitor Functions	2
Monitor Options	3
Monitor Ranges	8
O	
Options	
Programmable	3
Monitor	3
P	
Programmable Options	3
R	
Read Alert Setpoint Levels	11
Read Danger Setpoint Levels	11
Read Channel Vibration	9
Read Probe Gap Voltage	10
S	
Selftest	12





Artisan Technology Group is your source for quality new and certified-used/pre-owned equipment

- FAST SHIPPING AND DELIVERY
- TENS OF THOUSANDS OF IN-STOCK ITEMS
- EQUIPMENT DEMOS
- HUNDREDS OF MANUFACTURERS SUPPORTED
- LEASING/MONTHLY RENTALS
- ITAR CERTIFIED SECURE ASSET SOLUTIONS

SERVICE CENTER REPAIRS

Experienced engineers and technicians on staff at our full-service, in-house repair center

*InstraView*SM REMOTE INSPECTION

Remotely inspect equipment before purchasing with our interactive website at www.instraview.com ↗

WE BUY USED EQUIPMENT

Sell your excess, underutilized, and idle used equipment. We also offer credit for buy-backs and trade-ins. www.artisanng.com/WeBuyEquipment ↗

LOOKING FOR MORE INFORMATION?

Visit us on the web at www.artisanng.com ↗ for more information on price quotations, drivers, technical specifications, manuals, and documentation

Contact us: (888) 88-SOURCE | sales@artisanng.com | www.artisanng.com