



Artisan Technology Group is your source for quality new and certified-used/pre-owned equipment

- FAST SHIPPING AND DELIVERY
- TENS OF THOUSANDS OF IN-STOCK ITEMS
- EQUIPMENT DEMOS
- HUNDREDS OF MANUFACTURERS SUPPORTED
- LEASING/MONTHLY RENTALS
- ITAR CERTIFIED SECURE ASSET SOLUTIONS

SERVICE CENTER REPAIRS

Experienced engineers and technicians on staff at our full-service, in-house repair center

*InstraView*SM REMOTE INSPECTION

Remotely inspect equipment before purchasing with our interactive website at www.instraview.com ↗

WE BUY USED EQUIPMENT

Sell your excess, underutilized, and idle used equipment. We also offer credit for buy-backs and trade-ins. www.artisanng.com/WeBuyEquipment ↗

LOOKING FOR MORE INFORMATION?

Visit us on the web at www.artisanng.com ↗ for more information on price quotations, drivers, technical specifications, manuals, and documentation

Contact us: (888) 88-SOURCE | sales@artisanng.com | www.artisanng.com

Mechanical installation

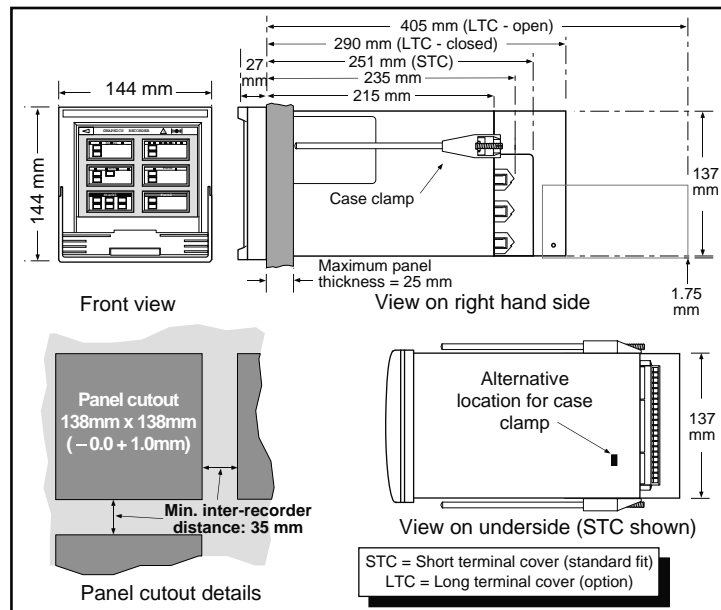

Supply voltage and input board termination

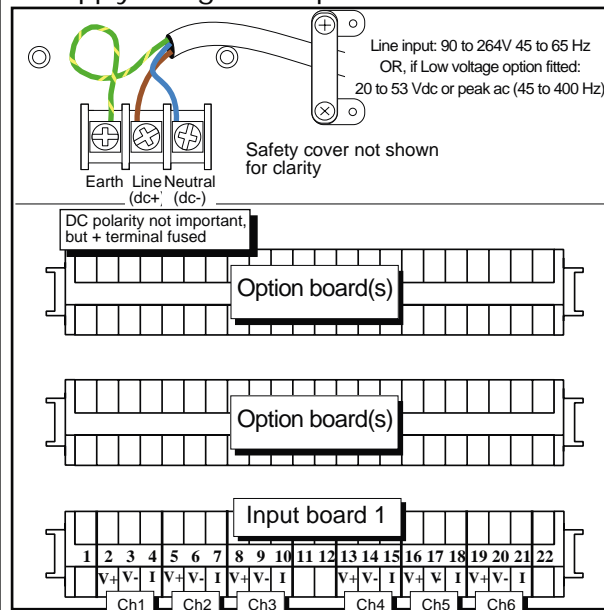

Input board signal wiring

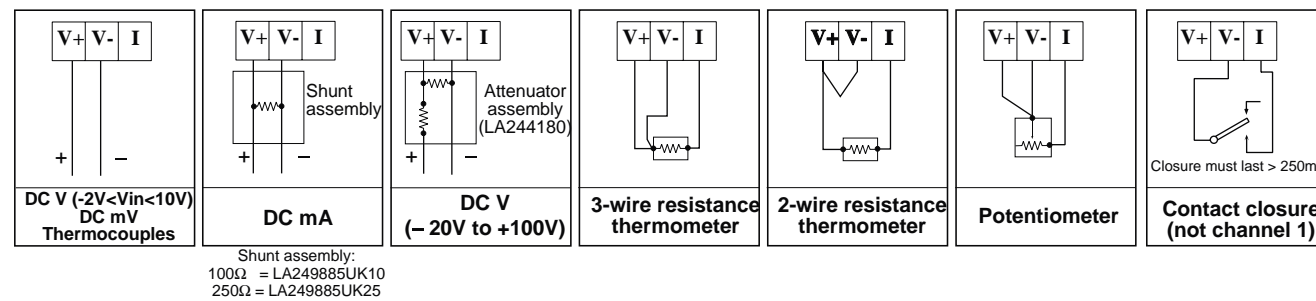

Option wiring

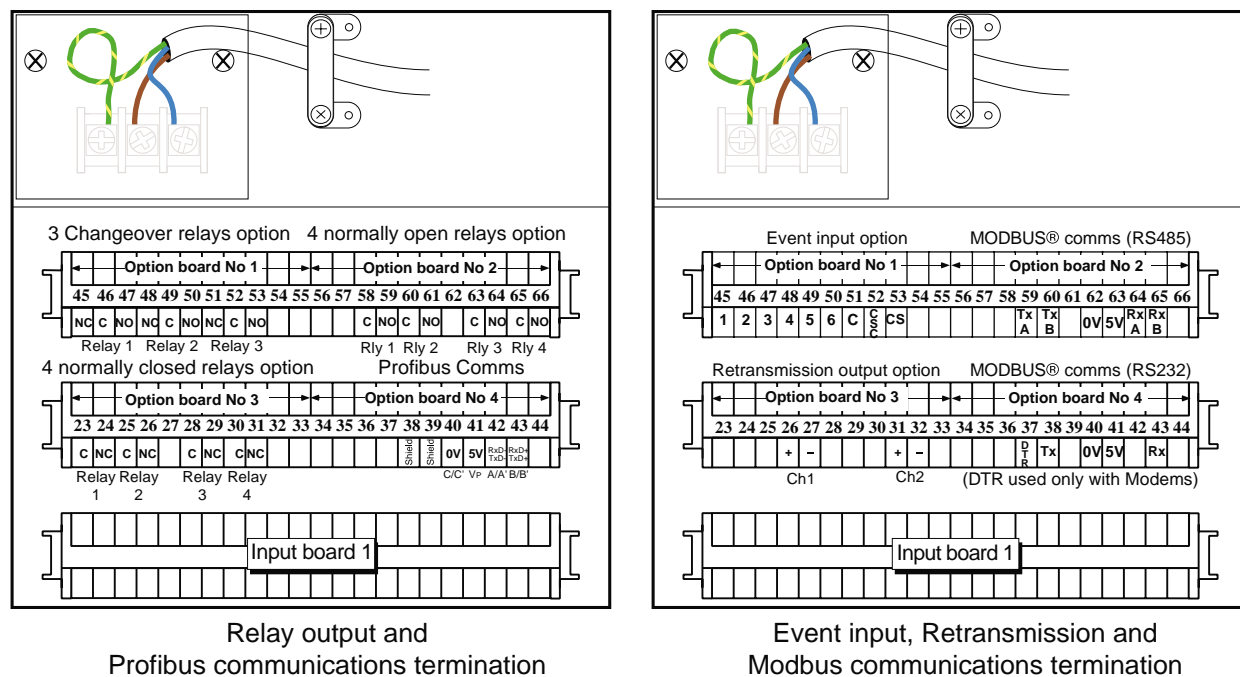

Model 4100G economique

Specification sheet

- Low cost
- 6-channel graphic recorder
- Large data archiving capability with integral PC card (up to 20MB) or Hard disk (up to 1GB)
- High quality colour display
- Configuration/operation via touch screen or via local or remote PC
- Timers, counters and totalisers
- MODBUS®/Profibus communications
- Relay outputs
- Analogue retransmission output

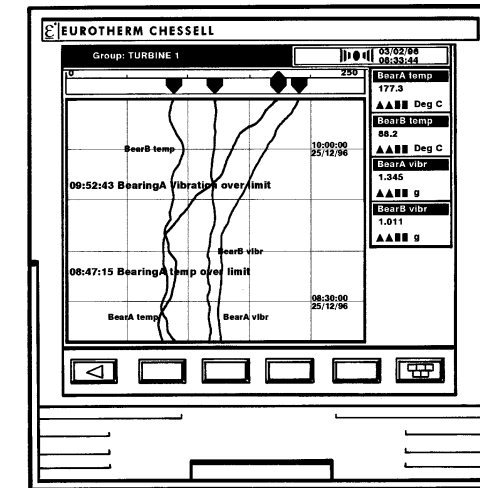

The 4100G economique is a low cost graphic recorder capable of plotting up to 6 input signals, totaliser values etc. Enclosed in a sheet steel case designed to meet the requirements of an industrial environment, the recorder is ideal for continuous and batch processes as well as test and QA applications.

Display

The display consists of a wide-view 5.5 inch TFT colour LCD overlaid with a tough touch-screen membrane and the whole fascia sealed to IP54 (IP65 optional). The display can show process values as if traced on a traditional chart, as bargraphs or in digital format.

Configuration

The recorder is fully configurable from the touch-screen using a simple menu system with text prompts. This allows access both to simple operator facilities and, via a password, to the input and instrument configuration. The recorder can also be configured from a DOS based PC package, allowing the user to set up the configuration off-site for later downloading to the recorder.

Input technology

Use of the very latest in Application Specific Integrated Circuit (ASIC) and surface mount technologies, gives the recorder input circuitry high accuracy and stability. Inputs are fully universal accepting inputs from thermocouples, resistance thermometers, potentiometers and digital signals.

Data Archiving

Channel values and instrument configurations can be stored on the integral PC memory card (up to 20MB) or hard disk (up to 1 GB). Data can be stored in an ASCII format that is readable in standard spread-sheet packages, or alternatively in a compressed tamper-proof format for export to Eurotherm's data analysis software package 'Review'.

File transfer

Archive files can be transferred from the recorder's integral memory-card/disk to a PC, either via a modem or by direct connection. In addition, configuration files can be sent to the recorder, thus allowing remote re-configuration. Data from several recorders can be imported directly into the PC (on an RS485 serial link), and viewed using Eurotherm 'Review' software.

MODBUS® Communications

The 4100G economique is an ideal data acquisition unit for a control plant SCADA system using the Modbus protocol to ensure compatibility. RS232 or RS485 specification can be used in single drop (RS232) or multidrop (RS485) applications using a single communications link.

Profibus Communications

All parameters available over the Modbus protocol are available, as an alternative, over a Profibus DP interface running at up to 12Mbps/sec. allowing direct communication with PLCs etc. Profibus configuration is carried out using the Eurotherm GSD File Editor.

Relay Outputs

Up to 16 relay outputs can be fitted, driven by any internal recorder event such as channel alarm, totaliser overflow etc. Relays are available as changeover, normally closed or normally open.

Retransmission outputs

Up to four of the input or maths channels can be output as a linearised current or voltage signal.

Contact inputs

Recorder inputs can be used as digital inputs to trigger events. The event input option adds the ability to read a further 16 (encoded) inputs.

Maths, Timers, Counters and Totalisers

Integrating, timing and counting options are available, as are the maths functions: copy, constant, add, subtract, multiply, divide and modulus.

TECHNICAL SPECIFICATION (Input board)

General

Input types	dc Volts, dc millivolts, dc milliamps (with shunt), Thermocouple, 2 / 3-wire RTD Contact closure (not chan. 1) >250ms
Input type mix	Freely configurable.
Maximum number of inputs	6
Input ranges	- 8 to + 38mV; - 30 to + 150 mV; - 0.2 to +1 Volt; - 2 to + 10 V; - 20 to + 100V with attenuator.
Termination	Edge connector / terminal block
Noise rejection (48 to 62 Hz)	Common mode: >140dB (channel to channel and channel to ground). Series mode: >60dB.
Maximum common mode voltage	250 Volts continuous
Maximum series mode voltage	45 mV at lowest range; 12 Volts peak at highest range.
Isolation (dc to 65 Hz; BS EN61010)	Installation cat II; Pollution degree 2
Channel to channel:	300V RMS or dc (double insulation)
Channel to common electronics:	300V RMS or dc (double insulation)
Channel to ground:	300V RMS or dc (basic insulation)
Dielectric strength (BS EN61010)	(1 minute type tests)
Channel to channel	2300 Vac
Channel to ground	1350 Vac
Insulation resistance	>10 MΩ at 500 V dc
Input impedance	38mV, 150 mV, 1 V ranges: >10 MΩ; 10 V range: 68.8 kΩ
Over voltage protection	50 Volts peak (150V with attenuator)
Open circuit detection	± 57 nA max.
Recognition time	500 msec
Minimum break resistance	10 MΩ

DC Input ranges

Shunt	Externally mounted resistor modules
Additional error due to shunt	0.1% of input
Additional error due to attenuator	0.2% of input
Performance	See table 1

Low Range	High Range	Resolution	Maximum error (Instrument at 20°C)	Worst case temperature performance
-8 mV	38mV	1.4µV	0.085% input + 0.073% range	80ppm of input per deg C
-30 mV	150mV	5.5µV	0.084% input + 0.053% range	80ppm of input per deg C
-0.2 Volt	1 Volt	37µV	0.084% input + 0.037% range	80ppm of input per deg C
-2 Volts	10 Volts	370µV	0.275% input + 0.040% range	272ppm of input per deg C

Table 1 DC performance

INSTALLATION CATEGORY II
The rated impulse voltage for equipment on nominal 230V mains is 2500V.
POLLUTION DEGREE 2
Normally, only non-conductive pollution occurs. Occasionally, however, a temporary conductivity caused by condensation shall be expected.

Input board specification (Cont.)

Thermocouple data

Temperature scale	ITS 90
Bias current	0.05 nA
Cold junction types	Off, internal, external, remote
CJ error	1°C max with inst. at 25°C
CJ rejection ratio	50:1 minimum
Remote CJ	Via any user-defined channel
Upscale / downscale drive	High, low or none selectable for each thermocouple channel
Types and ranges	See table 2

T/C Type	Overall range (°C)	Standard	Max linearisation error
B	0 to + 1820	IEC 584.1	0 to 400°C: 1.7°C 400 to 1820°C: 0.03°C
C	0 to + 2300	Hoskins	0.12°C
D	0 to + 2495	Hoskins	0.08°C
E	- 270 to + 1000	IEC 584.1	0.03°C
G2	0 to + 2315	Hoskins	0.07°C
J	- 210 to + 1200	IEC 584.1	0.02°C
K	- 270 to + 1372	IEC 584.1	0.04°C
L	- 200 to + 900	DIN43700:1985 (To IPTS68)	0.20°C
N	- 270 to + 1300	IEC 584.1	0.04°C
R	- 50 to + 1768	IEC 584.1	0.04°C
S	- 50 to + 1768	IEC 584.1	0.04°C
T	- 270 to + 400	IEC 584.1	0.02°C
U	- 200 to + 600	DIN 43710:1985	0.08°C
Ni/NiMo	0 to + 1406	Ipsen	0.14°C
Platinel	0 to + 1370	Engelhard	0.02°C

Table 2 Thermocouple types and ranges

Resistance inputs

Ranges (including lead resistance)	0 to 150 Ω, 0 to 600 Ω, 0 to 6k Ω
Influence of lead resistance	Error = negligible; Mismatch = 1 Ω/Ω
Temperature scale	ITS90
Accuracy and resolution	See table 3
RTD types, ranges and accuracies	See table 4

Low Range	High Range	Resolution	Maximum error (Instrument at 20°C)	Worst case temperature performance
0Ω	150Ω	5mΩ	0.045% input + 0.110% range	35ppm of input per deg C
0Ω	600Ω	22mΩ	0.045% input + 0.065% range	35ppm of input per deg C
0Ω	6kΩ	148mΩ	0.049% input + 0.035% range	35ppm of input per deg C

Table 3 Resistance ranges - accuracy and resolution

RTD Type	Overall range (°C)	Standard	Max linearisation error
Cu10	-20 to + 400	General Electric Co.	0.02 °C
JPT100	-220 to + 630	JIS C1604:1989	0.01 °C
Ni100	- 60 to + 250	DIN43760:1987	0.01 °C
Ni120	-50 to + 170	DIN43760:1987	0.01 °C
Pt100	-200 to + 850	IEC 751	0.01 °C
Pt100A	-200 to + 600	Eurotherm Recorders SA	0.09 °C
Pt1000	-200 to + 850	IEC 751	0.01 °C

Table 4 RTD types and ranges

TECHNICAL SPECIFICATION (Recorder)

Board types and hardware options

Universal input / control board (standard)
3- Change-over relay output board
4 Normally open relay o/p board
4 Normally closed relay o/p board
Analogue output board (2 channel)
Event input board
Modbus communications board
Profibus communications board
Transmitter power supply

Environmental Performance

Temperature limits	Operation: 0 to 50°C (0 to 40°C if PC card hard disk fitted) Storage: -20 to + 70°C
Humidity limits (non-condensing)	Operation: 5% to 80% RH Storage: 5% to 90% RH
Protection	Door and Bezel: IP54 (IP65 optional). Sleeve: IP20 Transmitter PSU rear cover: IP10
Shock	BS EN61010
Vibration	2g peak

Electromagnetic compatibility (EMC)

Emissions	BS EN50081-2
Immunity	BS EN50082-2
Electrical safety (BS EN61010)	Installation cat. II; Pollution degree 2

Physical

Panel mounting	DIN43700
Bezel size	144 x 144 mm.
Panel cutout dimensions	138 x 138 (both - 0 + 1 mm)
Depth behind bezel rear face	235 mm (no terminal cover); 251 mm (with terminal cover) 290 mm (long terminal cover - closed) 405 mm (long terminal cover - open) < 3.5kg
Weight	
Panel mounting angle	Recorders with hard disk option: Vertical panels only Recorders with floppy disk option: Vertical ± 15 degrees max. Other 4100GE recorders: Vertical ± 45 degrees max.

Operator interface

Type	Colour TFT LCD with cold cathode backlighting. Fitted with resistive, analogue, toughened touch-panel
------	---

Power requirements

Line voltage	45 to 65 Hz	90 to 264V (standard) 90 to 132 V (enhanced interrupt protection option) low voltage option 20 to 54V dc or 20 to 53V ac at 45 to 400 Hz
Power (Max)		< 100 VA
Fuse type		None
Interrupt protection	Standard	40 ms at 75% max. instrument load
	Enhanced	120 ms at 75% max. instrument load

TECHNICAL SPECIFICATION (Options)

MODBUS (RS232/RS422/RS485) Communications

Isolation†	Terminals to ground	100V RMS/dc (basic insulation)
------------	---------------------	--------------------------------

Profibus (RS485) Communications

Isolation†	Terminals to ground	50V RMS/dc (basic insulation)
------------	---------------------	-------------------------------

Relay outputs

Maximum ac switching power*	500VA
Maximum ac breaking current*	2 Amps within above power rating
Maximum ac contact voltage*	250V within above power rating
Maximum dc ratings	See graph 2
Isolation†	Contact to contact: 300V RMS or dc (double insulation) Contact to ground: 300V RMS or dc (basic insulation)
Estimated life*	30,000,000 operations

* With resistive loads. With inductive loads, derate according to graph 1, in which: contact life = resistive life x F1 or F2
where F1 = measured on representative examples
F2 = typical values according to experience.

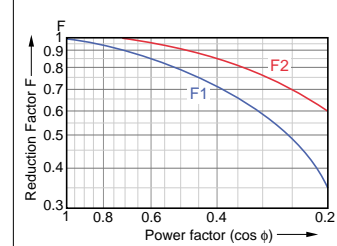

Graph 1 Derating curves

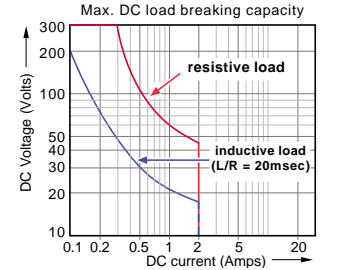

Graph 2 DC ratings

Analogue (retransmission) outputs

Output ranges (user configurable)	Voltage: 0 to 10 V (Source 5 mA max.) Current: 0 to 20mA (max. load resistance: 1kΩ)
Update rate	2 Hz.
Step response (10% to 90%)	250msec
Linearity	0.024% of hardware range
Performance	See table 5
Isolation†	Channel to channel: 300V RMS or dc (double insulation) Channel to ground: 300V RMS or dc (basic insulation)

Performance in instrument at 20 deg. C		
Range	Accuracy	Temperature drift
0 to 10 V	0.1% of range	±0.12mV +0.022% of reading per deg. C
0 to 20mA	0.1% of range	± 1 µA +0.03% of reading per deg. C

Table 5 Analogue output performance

Event inputs

N° of inputs	6 discrete or 16 binary coded inputs as configured
Isolation†	Event input to ground: 100V RMS or dc (double insulation) Chart drive to ground: 100V RMS or dc (double insulation) Event input to chart drive: 100V RMS or dc (double insulation) Event input to Event input: OV.
Recognition levels	Low: -30 V to + 0.8V High: 2 to 30 V
Maximum frequency	Events: 1Hz; Pulse counting: 6Hz
Minimum pulse width	62.5 ms.
Chart synchronization	Chart speed: Selected speed at 200 pulses/sec. Maximum pulse rate: 220 pulses per second Duty cycle: 20 to 80%

Transmitter Power Supply

Output voltage	3 or 6 x 25V (nom) outputs
Isolation†	Channel to channel: 100V RMS or dc (double insulation) Channel to ground: 100V RMS or dc (basic isolation)

Seismic

Tested to IEEE344 - 1987 'IEEE recommended practice for Seismic qualification of class 1E equipment for Nuclear Power Generating Stations'

†All isolation figures are: DC to 65Hz; BS EN61010 Installation category II; Pollution degree 2



Artisan Technology Group is your source for quality new and certified-used/pre-owned equipment

- FAST SHIPPING AND DELIVERY
- TENS OF THOUSANDS OF IN-STOCK ITEMS
- EQUIPMENT DEMOS
- HUNDREDS OF MANUFACTURERS SUPPORTED
- LEASING/MONTHLY RENTALS
- ITAR CERTIFIED SECURE ASSET SOLUTIONS

SERVICE CENTER REPAIRS

Experienced engineers and technicians on staff at our full-service, in-house repair center

*InstraView*SM REMOTE INSPECTION

Remotely inspect equipment before purchasing with our interactive website at www.instraview.com ↗

WE BUY USED EQUIPMENT

Sell your excess, underutilized, and idle used equipment. We also offer credit for buy-backs and trade-ins. www.artisanng.com/WeBuyEquipment ↗

LOOKING FOR MORE INFORMATION?

Visit us on the web at www.artisanng.com ↗ for more information on price quotations, drivers, technical specifications, manuals, and documentation

Contact us: (888) 88-SOURCE | sales@artisanng.com | www.artisanng.com