



## Artisan Technology Group is your source for quality new and certified-used/pre-owned equipment

- FAST SHIPPING AND DELIVERY
- TENS OF THOUSANDS OF IN-STOCK ITEMS
- EQUIPMENT DEMOS
- HUNDREDS OF MANUFACTURERS SUPPORTED
- LEASING/MONTHLY RENTALS
- ITAR CERTIFIED SECURE ASSET SOLUTIONS

### SERVICE CENTER REPAIRS

Experienced engineers and technicians on staff at our full-service, in-house repair center

### *InstraView*<sup>SM</sup> REMOTE INSPECTION

Remotely inspect equipment before purchasing with our interactive website at [www.instraview.com](http://www.instraview.com) ↗

### WE BUY USED EQUIPMENT

Sell your excess, underutilized, and idle used equipment. We also offer credit for buy-backs and trade-ins. [www.artisanng.com/WeBuyEquipment](http://www.artisanng.com/WeBuyEquipment) ↗

### LOOKING FOR MORE INFORMATION?

Visit us on the web at [www.artisanng.com](http://www.artisanng.com) ↗ for more information on price quotations, drivers, technical specifications, manuals, and documentation

**Contact us:** (888) 88-SOURCE | [sales@artisanng.com](mailto:sales@artisanng.com) | [www.artisanng.com](http://www.artisanng.com)

**WARNING**  
**MANUFACTURER ASSUMES NO LIABILITY**  
**IF UNIT OPERATED IN AN UNSAFE MANNER**

**WARNING**  
**THIS INSTRUMENT GENERATES AND**  
**DELIVERS A HAZARDOUSLY HIGH**  
**VOLTAGE (5kV). BE EXTREMELY CAREFUL**  
**WHEN USING THIS INSTRUMENT. BE SURE**  
**TO READ MANUAL SECTION 3**  
**PRECAUTIONS BEFORE OPERATING.**

### EC Declaration of Conformity

We  
**GOOD WILL INSTRUMENT CO., LTD.**  
No. 7-1, Jhongsing Rd., Tucheng City, Taipei County 236, Taiwan.  
**GOOD WILL INSTRUMENT (SUZHOU) CO., LTD.**  
No. 69 Lushan Road, Suzhou New District Jiangu, China.  
declares that the below mentioned products  
**GPT-705A/715A, GPI-725A/735A/745A**  
are herewith confirmed to comply with the requirements set out in the Council Directive on the Approximation of the Law of Member States relating to Electromagnetic Compatibility (89/336/EEC, 92/31/EEC) and Low Voltage Equipment Directive (73/23/EEC, 93/68/EEC).  
For the evaluation regarding the Electromagnetic Compatibility and Low Voltage Equipment Directive, the following standards were applied:

<b>EN 61326-1: Electrical equipment for measurement, control and laboratory use — EMC requirements (1997+A1: 1998+A2:2001)</b>	
Conducted and Radiated Emissions EN 55011 Group I class A: 1998	Electrostatic Discharge EN 61000-4-2: 1995+A1 :1998
Current Harmonic EN 61000-3-2: 2000	Radiated Immunity EN 61000-4-3: 1996+A1 :1998
Voltage Fluctuation EN 61000-3-3: 1995	Electrical Fast Transients EN 61000-4-4: 1995
	Surge Immunity EN 61000-4-5: 1995
	Conducted Susceptibility EN 61000-4-6: 1996
	Voltage Dips/ Interrupts EN 61000-4-11: 1994

**Low Voltage Equipment Directive 73/23/EEC & amended by 93/68/EEC**  
Safety Requirements  
IEC/EN 61010-1: 2001  
Remark: Also complied with Continuity of Protective Bonding Tester, Insulation Resistance Test, Voltage Test, and Residual Voltage Test in accordance with the Sub-Clauses 19.2, 19.3, 19.4 and 19.5 of EN 60204-1: 1997

CONTENTS	PAGE
1. PRODUCT INTRODUCTION.....	1
1-1.Description.....	1
1-2.Feature.....	2
2. SPECIFICATION.....	4
3. PRECAUTIONS BEFORE OPERATION.....	9
3-1.Unpacking the instrument.....	9
3-2.Safety notice.....	9
3-3.Environment.....	11
4. PANEL INTRODUCTION.....	12
4-1.Front Panel.....	12
4-2.Rear Panel.....	13
5. OPERATION METHOD.....	16
5-1.Main display LCD.....	16
5-2.Prepare the EST for Use.....	19
5-3.Structure of storage steps.....	29
5-4.Menu parameter setup.....	31
6. MAINTENANCE.....	40
6-1.Fuse rating and type.....	40
6-2.Cleaning.....	40

## SAFETY TERMS AND SYMBOLS

These terms may appear in this manual or on the product:



**WARNING.** Warning statements identify condition or practices that could result in injury or loss of life.



**CAUTION.** Caution statements identify conditions or practices that could result in damage to this product or other property.



The equipment shall not be used for measurements within category II, III and IV.

The following symbols may appear in this manual or on the product:



**DANGER**  
High Voltage



**ATTENTION**  
refer to Manual



**Protective**  
Conductor  
Terminal



**Earth (ground)**  
Terminal

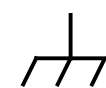

**Frame or**  
Chassis  
Terminal

## FOR UNITED KINGDOM ONLY

**NOTE:** This lead/appliance must only be wired by competent persons.

### WARNING: THIS APPLIANCE MUST BE EARTHED

**IMPORTANT:** The wires in this lead are coloured in accordance with the following code:

Green/ Yellow:	Earth
Blue:	Neutral
Brown:	Live (Phase)

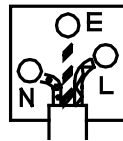

As the colours of the wires in main leads may not correspond with the colours marking identified in your plug/appliance, proceed as follows:

The wire which is coloured Green & Yellow must be connected to the Earth terminal marked with the letter E or by the earth

symbol  or coloured Green or Green & Yellow.

The wire which is coloured Blue must be connected to the terminal which is marked with the letter N or coloured Blue or Black.

The wire which is coloured Brown must be connected to the terminal marked with the letter L or P or coloured Brown or Red.

If in doubt, consult the instructions provided with the equipment or contact the supplier.

This cable/appliance should be protected by a suitably rated and approved HBC mains fuse: refer to the rating information on the equipment and/or user instructions for details. As a guide, cable of 0.75mm<sup>2</sup> should be protected by a 3A or 5A fuse. Larger conductors would normally require 13A types, depending on the connection method used.

Any moulded mains connector that requires removal /replacement must be destroyed by removal of any fuse & fuse carrier and disposed of immediately, as a plug with bared wires is hazardous if engaged in live socket. Any re-wiring must be carried out in accordance with the information detailed on this label.

## 1. PRODUCT INTRODUCTION

### 1-1. Description

The GPT/GPI-700A series Electrical Safety Testers (EST) are designed for AD/DC Withstanding Voltage test, Insulation Resistance test (IR) and Ground Bond test (GB) in order to provide a safe and accurate test environment for the operator. With thoughtful design described in 1-2. Feature insures a safe operation of high voltage test and protect user from hazardous impact. Besides, the series can be used together with scanner box of SHB-001-1 & SHB-001-2.

The Electrical Safety Testers comply with the requirement of the electrical equipment & appliance control ordinances and JIS, CSA, UL, BS and other overseas standards as well. The testers can be used for withstanding voltage test of the various types of electrical and equipment and components.

The GPT/GPI-700A series are based on the family of GW withstanding voltage tester including AC Withstanding Voltage test, DC Withstanding Voltage test, Insulation Resistance test and Ground Bond test (GB).

Function Model	AC	DC	IR	GB
GPI-745A	✓	✓	✓	✓
GPI-735A	✓	✓	✓	
GPI-725A	✓		✓	
GPT-715A	✓	✓		
GPT-705A	✓			

### 1-2. Features

The GPT/GPI-700A series offer several other features:

#### 1) No load setup of trip current and output voltage

A safe way to setup trip current and output voltage without high voltage activated.

#### 2) A large 24×2 character LCD with adjustable LED backlight

Provide a clear display about test parameters, which including group, step, mode, status, output voltage, trip current and test time.

#### 3) Easily and quickly setup by front panel

A user-friendly interface provides user an easy and quick way to set all parameters.

#### 4) Electronic ramping and testing

Digital controlled ramping time and testing time.

#### 5) Line and load regulation

Linear amplifier and feedback-control maintain output voltage disregard of the variation of load.

#### 6) Selectable output frequency

50/60 Hz is selectable by utility setup.

#### 7) Adjustable ARC detect level

ARC detect level could be setup by utility setup.

#### 8) 10 groups of storage and each group has 16 steps

Total 10 storage groups provided for testing of different products, and each group has 16 steps.

#### 9) Adjustable output voltage during test

A special test mode in step 0, user could adjust the output voltage during testing

**10) Flashing high voltage indicator**

A flashing red LED indicates dangerous situation during high voltage output is activated.

**11) Data lock function**

Front panel could be locked or unlocked by utility setup.

**12) PLC remote control**

The 9-pin interface provides inputs (START, RESET) and outputs (TEST, PASS, FAIL).

**13) Compact size with multi-capability**

The compact size is geared with the Safety Test capabilities including AC Withstanding test, DC Withstanding test, Insulation Resistance test and Ground Bond test.

**14) R/P Output**

The output terminal located on the rear panel.

**15) Scanner Interface**

**16) RS-232 and GPIB Interface**

The RS-232 and GPIB interface enables remote control operation and signal processing via a PC.

**2. SPECIFICATION (15°C~35°C RH≤75%)**

<b>1) AC Hi-Pot Specifications</b>	
Voltage Range	0.100~5.000kV
Voltage Step	5V/step
Voltage Regulation (line & load)	1% + 5V
Voltage Accuracy	±1% of reading ±10V (above 500V)
Current Sourcing *	30~40mA(above 500V, maximum test time: 180 sec) 0.10~29.99mA(above 500V, continuous test) 0.10~10mA(below 500V, continuous test)
Current Limit	0.10~40mA, 0.02mA/step
Current Accuracy	±1% of reading ± 80 μ A
<b>2) DC Hi-Pot Specifications (for GPT-715A/GPI-735A/745A only)</b>	
Voltage Range	0.100~6.000kV
Voltage Step	5V/step
Voltage Regulation (line & load)	1% + 5V
Voltage Accuracy	±1% of reading ±10V(above 500V)
Current Sourcing *	0.10~10.00mA(above 500V, continuous test) 0.10~2mA(below 500V, continuous test)
Current Limit	0.10~10mA, 0.01mA/step
Current Accuracy	±1% of reading ± 50 μ A

<b>3) Insulation Resistance Specifications (for GPI-725A/ 735A/ 745A only)</b>	
DC Voltage	50V/100V/500V/1000V
Resistance Accuracy	50V/100V: 1~50MΩ: ±5% of reading ±1 count 51~200MΩ: ±10% of reading ±1 count 201~1990MΩ: ±20% of reading±1 count 500V/1000V: 1~500MΩ: ±5% of reading ±1 count 501~2000MΩ: ±10% of reading±1 count 2001~9999MΩ: ±20% of reading±1 count
<b>4) Ground Bond Specifications (for GPI-745A only)</b>	
Test Voltage	Max. 8V(DC)
Current Range	3~42A
Current Resolution	0.02A
Current Accuracy	±1% of reading ±0.2A (3~8A) ±1% of reading ±50mA (9~42A)
Resistance Range	0~600mΩ
Resistance Resolution	0.1mΩ
Resistance Accuracy	±1% of reading ±3mΩ
Test Method	Four Terminals Test Mode
<b>5) Continuity Check Specifications (for GPT-705A/715A/ GPI-725A/ 735A only)</b>	
Output Current Range	0.1A(DC)
Compliance Voltage Range	10%
Current Resolution	0.1 Ω, 1 Ω

<b>6) Ramp Time and Test Time</b>	
AC Hi-Pot Ramp/Test time	000.0~999.9s Ramp/000.5~999.9 test
DC Hi-Pot Ramp/Test time	000.0~999.9s Ramp/000.5~999.9 test
Insulation Resistance Test time	001.0~999.9s
Ground Bond Test Time	000.5~999.9s
Continuity Check Test Time	000.5~999.9s
<b>7) ARC Detect</b>	
Detect Current	40 level (1~40mA)
<b>8) Storage</b>	
Groups	10
Steps	16
<b>9) Interface</b>	
RS-232	Standard
GPIB	Option
<b>10) PLC Control</b>	
D-sub 9 pins female	Standard
<b>11) Scanner Interface</b>	
D-sub 9 pins female	Standard
<b>12) Real Plate Output</b>	
Hi-pot terminals and GB terminals	Standard interface for GPI-745A only, option for the other models

<b>13) General</b>	
Power Source	AC100V, 120V, 220V, 230V±10% 50/60Hz
Operation Environment	Indoor use, altitude up to 2000m. Ambient Temperature 0°C to 40°C. Relative Humidity 80% (Maximum). Installation category II Pollution Degree 2
Storage temperature & Humidity	-10°C to 70°C. 70% (Maximum).
Accessories	GHT-105A × 1, GTL-115 × 1(only for GPI-745A), Instruction manual × 1, Interface Manual × 1
Dimension	446(L) × 330(W) × 149(H) (m/m)
Weigh	Approx. 14.9 kgs

- \* The main purpose provided by the series of instruments is for Puncture Testing. The specification is not for continuous test. The temperature of heat-sink is monitored. The test procedure will stop if the heat-sink is too hot. Please refer to Figure 2-1.
- \* Stop the instrument for 10 minutes when continuously proceeding 30~40mA withstanding test for one hour.

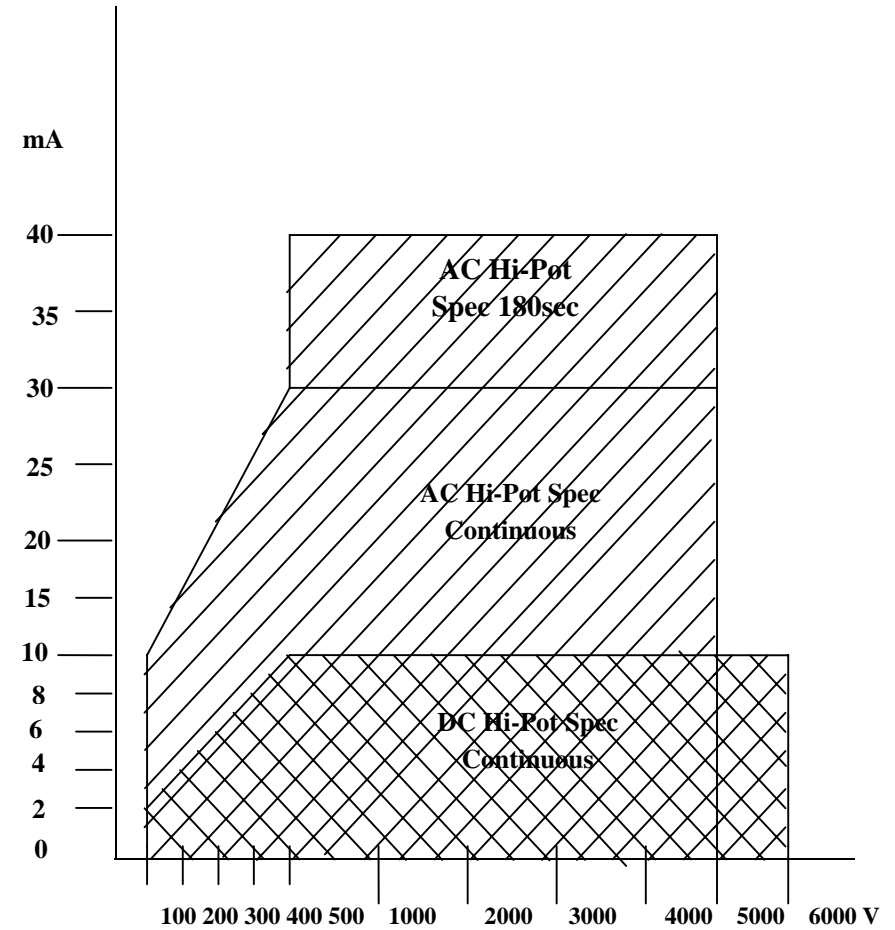

Figure 2-1



### 3. PRECAUTIONS BEFORE OPERATION

#### 3-1. Unpacking the instrument

The product has been fully inspected and tested before shipping from the factory. Upon receiving the instrument, please unpack and inspect it to check if there is any damage caused during transportation. If any sign of damage is found, notify the bearer and/or the dealer immediately.

#### 3-2. Safety Notice

##### Working place

The working place must be isolated and when the high voltage is proceeding, it should be alerted with a warning sign of dangerous for special caution.

##### Checking the Line Voltage

The instruments can be applied with any kind of line voltage shown in the table below. Before connecting the power plug to an AC line outlet, make sure the voltage selector of the rear panel is set to the correct position corresponding to the line voltage. It might be damaged the instrument if connected to the wrong AC line voltage.



**WARNING. To avoid electrical shock the power cord protective grounding conductor must be connected to ground.**



**The equipment shall not be used for measurements within category II, III and IV.**

When line voltages are changed, replace the required fuses shown as below:

Line voltage	Range	Fuse	Line voltage	Range	Fuse
100V	90-110V	T 7.0A	220V	198-242V	T 4A
120V	108-132V	250V	230V	207-250V	250V



**WARNING. To avoid personal injury, disconnect the power cord before removing the fuse holder.**

#### Operator's Precaution

- (1) With immense high output voltage and current of the puncture tester, only qualified person can operate the tester in order to avoid fatal electric shock.
- (2) On-job training is required for operator to better use the tester smoothly and safely.
- (3) The operator is prohibited to dress with metal ornaments or wear metal decoration in order to avoid electric shock.
- (4) The person with cardiac or wear a pacemaker must not to operate the tester.



**WARNING: This is a Class A product. In a domestic environment this product may cause radio interference in which case the user may be required to take adequate measures.**

### Secure Testing

Never operate the tester in the place with electric circuit device around.

The earth lead should be well connected in accordance with instruction. The Return Lead has to be connected to the tested object first before linking up test probe. Do not plug the high voltage test probe to the high voltage output terminal before doing the testing. Also, do not touch the electric conductor of test probe and the operator has to fully control the power on/off by using switch or remote control, which should not be lay aside carelessly.



**WARNING:** During the testing, do not touch the tested object or any other connected objects.

### 3-3.Environment

The normal ambient temperature range of this instrument is from 0° to 40°C (32° to 104°F). To operate the instrument over this specific temperature range may cause damage to the circuits.

Do not use the instrument in a place where strong magnetic or electric field exists as it may disturb the measurement.

## 4. PANEL INTRODUCTION

### 4-1. Front Panel

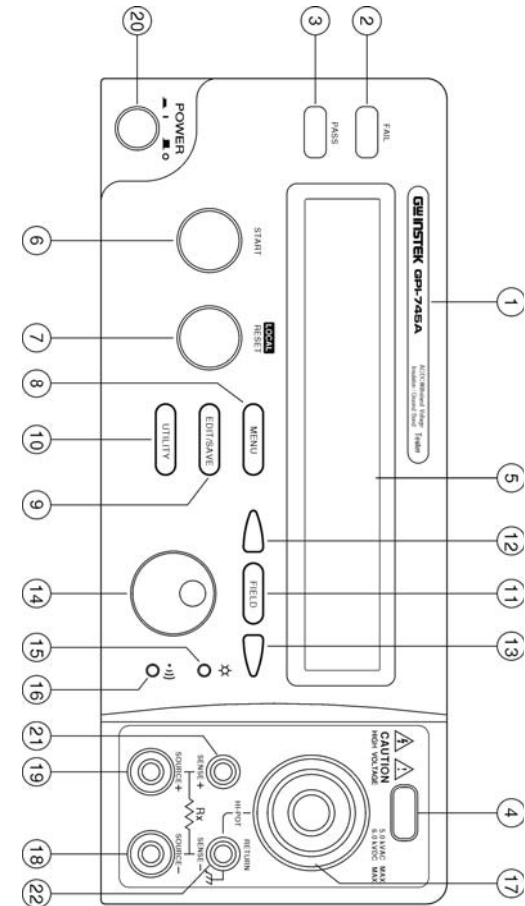

4-2. Rear Panel

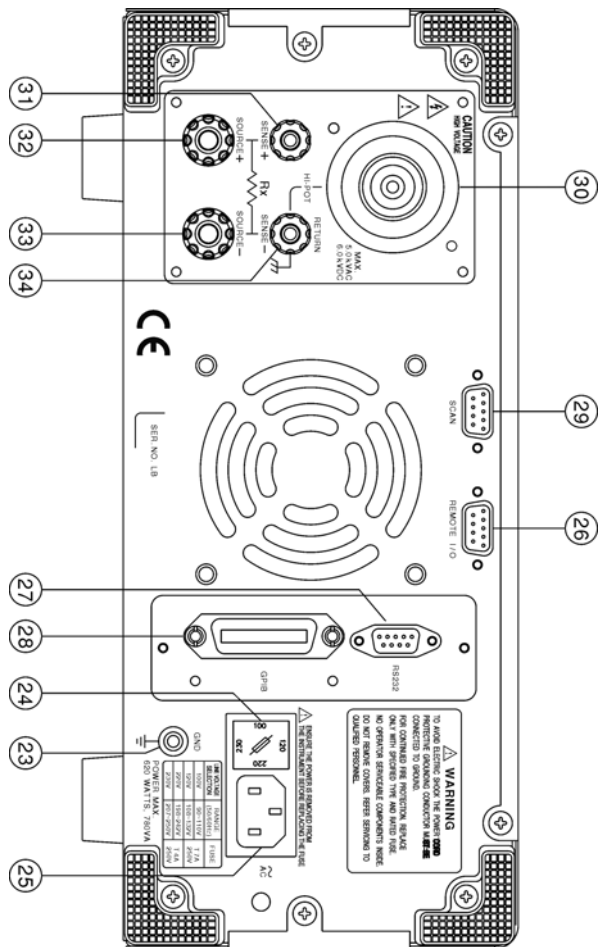

1	Model Number	Model number and description
2	FAIL Indicator LED	The red LED indicates failure of test procedure
3	PASS Indicator LED	The green LED indicates pass of test procedure
4	CAUTION Indicator LED	During test the red LED will flash to indicate dangerous.
5	Main Display LCD	The LCD displays all message about test procedure.
6	START Button	Press the green button to start a test procedure.
7	RESET Button	Press the red button to reset/stop a test procedure.
8	MENU Key	When you press the MENU key, the status becomes MENU and you can browse all groups.
9	EDIT/SAVE Key	When you press the EDIT/SAVE key, the status EDIT is active and you can edit this step or setup. Press the EDIT/SAVE key again will save this step or setup.
10	UTILITY Key	When you press the UTILITY key, the status UTILITY is active and you can view all the utility setups.
11	FIELD Key	When you edit the test step, press the FIELD key to change the active parameter of stop.
12	Left Arrow Key	Press the arrow key to adjust knob's resolution.
13	Right Arrow Key	Press the arrow key to adjust knob's resolution.
14	Knob	If status EDIT is active, turn the knob to increase or decrease the value of active parameter. If status MENU is active, turn the knob to increase or decrease active Step.
15	LCD Backlight Adjustment	Turn the VR to adjust the LED backlight of LCD.
16	Buzzer Volume Adjustment	Turn the VR to adjust the buzzer volume.
17	High Voltage Output Seat	High voltage output terminal.
18	SOURCE-Terminal (only for Ground Bond Test)	High current terminal for Ground Bond test.

19	SOURCE+ Terminal (only for Ground Bond Test)	High current terminal for Ground Bond test.
20	Power Switch	Press the power switch to turn on the tester.
21	SENSE+ Terminal	Voltage Terminal for Ground Bond test.
22	SENSE- & Return Terminal	SENSE- Terminal is a voltage terminal for Ground Bond test, and Return Terminal is for all test.
23	Ground Terminal	Connect Ground terminal to the earth ground.
24	Fuse Holder with Voltage Selector	To change AC source voltage, pull the fuse holder and rotate it to the proper value.
25	AC Inlet	Connect the AC power line to the inlet.
26	Remote Interface	The remote interface performs all the functions of PLC control.
27	RS232 Terminal	D-SUB 9 pin connector, Input/Output connector for RS232.
28	GPIB Terminal	Blue 24 connector, Input/Output connector for IEEE-488.
29	Scanner Interface	D-sub 9 pins female connector for scanner box.
30	High Voltage Output on rear panel	High voltage output terminal.
31	Sense + Terminal on rear panel	Voltage terminal for Ground Bond test.
32	Source + Terminal on rear panel	High current terminal for Ground Bond test.
33	Source - Terminal on rear panel	High current terminal for Ground Bond test.
34	Sense - Terminal & Return Terminal on rear panel	Sense - terminal is a voltage terminal for Ground Bond test, Return terminal is for all tests.

\*The instrument can be used together with scanner box of SHB-001-1 & SHB-001-2.

\*The Instrument can control one scanner box only.

## 5. OPERATION METHOD

### 5-1. Main Display LCD

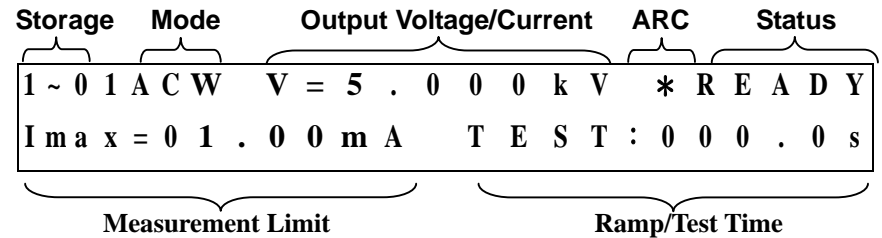

### Table of parameters

Storage	Group/ Step: There are total 10 groups, and each group has 16 steps. The first number represents group while the second number represents step. Ex. 3:1 3 is for group number, 1 is for step number.
Mode	The test mode of tester includes: ACW: AC Withstanding voltage test. DCW: DC Withstanding voltage test (only for GPT-715A/ GPI-735A/745A). I R : Insulation Resistance test (only for GPI-725A/GPI-735A /745A). G B : Ground Bond test (only for GPI-745A). C N T: Continuity Check test (only for GPT-705A/715A/ GPI-725A/735A) The total types of mode will change for different model.

Output Voltage/Current	Output voltage or current for each step A C : Output voltage (0.100~ 5.000 kV) D C : Output voltage (0.100~ 6.000 kV) I R : Output voltage (50V/100V/500V/1000V) G B : Output current (3.00~42.00A) C N T : Output current (10mA)
Status	The status of tester includes: M E N U : Browse and check steps of test. E D I T : Edit parameters S A V E : Save parameters U T I L : Browse and check system utility. R E A D Y : Ready for test T E S T : Testing P A S S : The result of test is pass F A I L : The result of test is fail S T O P : Stop the test
ARC	If the ARC function is enable, the sign “*” means that there is ARC during test.
Measurement Limit	Lower and upper limit of measurement I m a x / I m i n : Current measurement limit (ACW & DCW) R m a x / R m i n : Resistance measurement limit(IR&GB&CNT)
Ramp/Test Time	Ramp time and test time A C : Ramp (000.0~999.9s) Test (000.5~999.9s) D C : Ramp (000.0~999.9s) Test (000.5~999.9s) I R : Test (001.0~999.9s) G B : Test (000.5~999.9s) C N T : Test (000.5~999.9s)

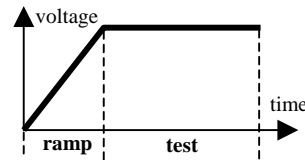

CHANNEL Hi: 00 Lo: 00	Set the Scanner Box to output and return function through the setting of CH1 and CH2. If the setting is Hi=01 and Lo=02, that means the high voltage is output from CH1 and return from CH2. If Hi and Lo are set to 00, that means no signal is sent to Scanner Box.
-----------------------------	---

- \* When the measured load becomes capacitive, the test time must be extended.
- \* Ramp Time  
Ramp Time setting provides a fast and safe way to detect short circuit or faulty wiring of your Device Under Test.

GPT-700A monitors the voltage level during the first stage of Ramp Time to find out short condition. If the voltage still remains less than 80V after 0.1s, GPT-700A cuts off the output and displays the message “Short”. Therefore the short current will be shut off before it grows beyond I<sub>max</sub>, the current limit setting.

When checking GPT-700A current accuracy, if the DUT has less than 2Mohm input impedance, turn off the Ramp Time setting. GPT-700A may shut down the voltage taking the low impedance as a sign of short circuit.

time

## 5-2. Prepare the EST for Use

- **To view the Storage Steps**

1. Press the **MENU** key to enter status MENU.

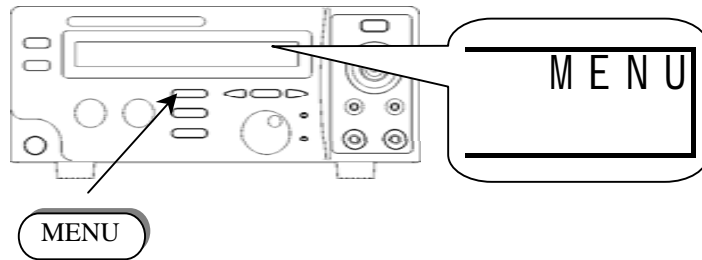

2. Use the left and right arrow keys to change knob's resolution (group or step). Use the knob to change the active step.

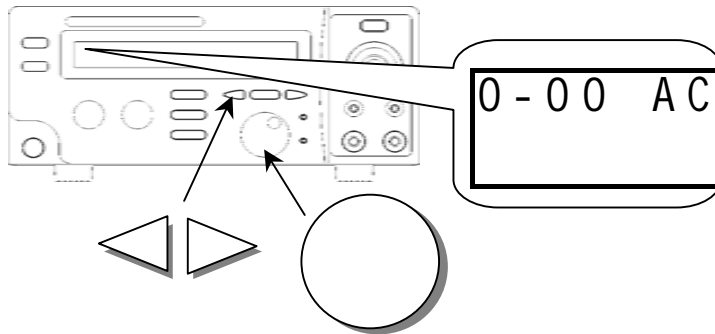

- **To Edit/Save the Storage Steps**

1. Follow the above procedure "To View the Storage Steps" to select a step.
2. Press the **EDIT/SAVE** key to enter status EDIT.

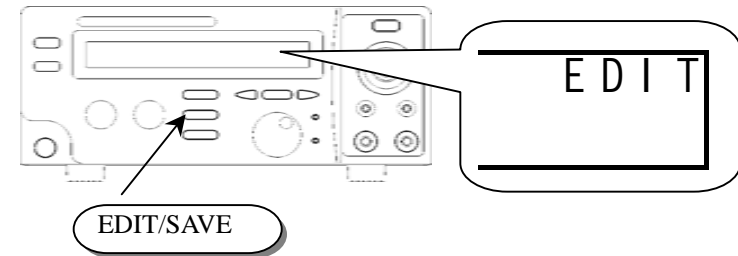

3. Use knob to adjust parameter. Use arrow keys to change knob's resolution.

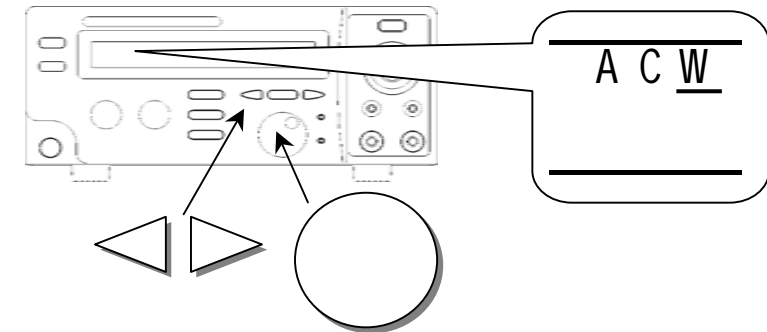

4. Use **FIELD** key to change active parameter.

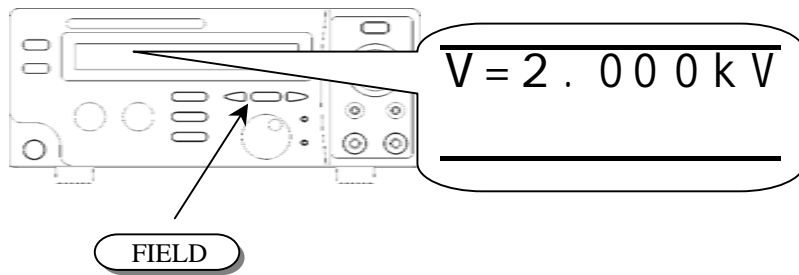

5. Repeat step 3 and 4 to adjust parameter.

6. After setting all parameters, press **EDIT/SAVE** key to save the step.  
The status will become SAVE. After the step is saved, the status will return to EDIT.

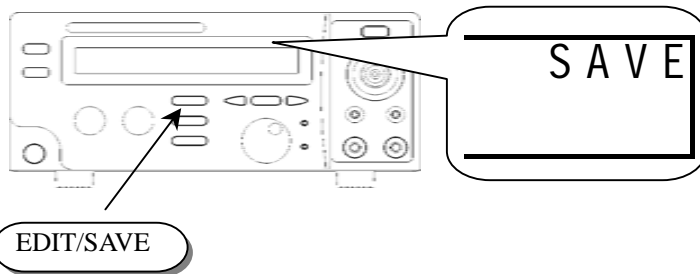

7. Repeat the procedure “**To View the Storage Steps**” to select another step.

● **To Begin a Group Test**

1. Repeat the procedure “**To View the Storage Steps**” to select a step.
2. Press RESET button to enter status READY.

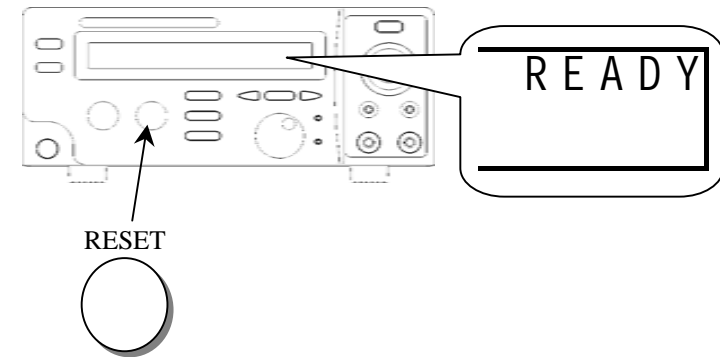

3. Make sure the test environment is safe.

4. Press START button to start the test while the status TEST is active and the CAUTION LED flashes.

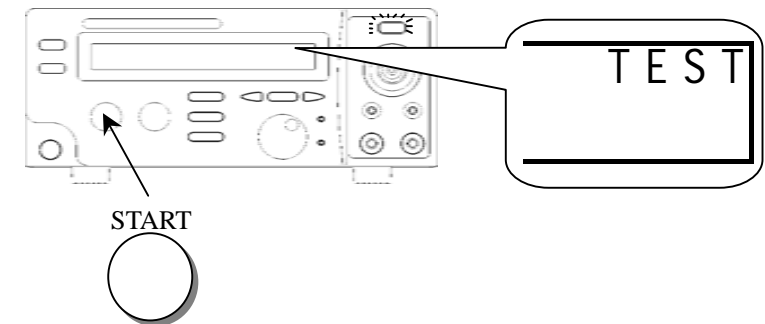

5. If you press RESET button the test will stop immediately.

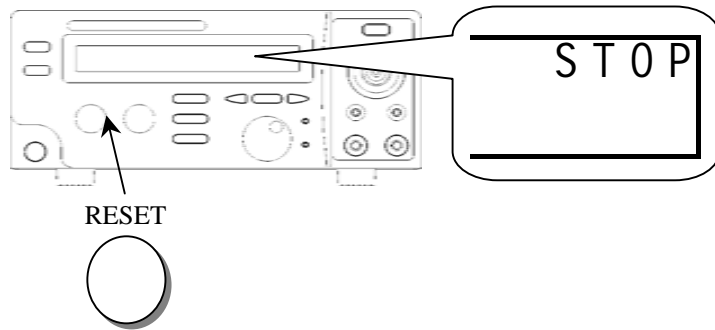

6. If the result is pass, the PASS LED will be active.

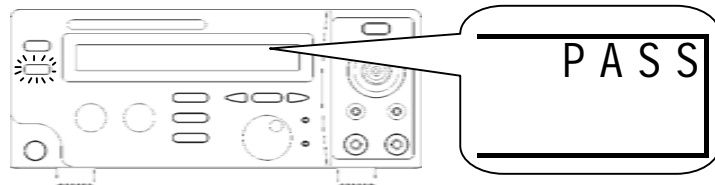

7. If the result fails, the FAIL LED will be activated and the buzzer will alarm operator. To stop the alarm, press RESET button again.

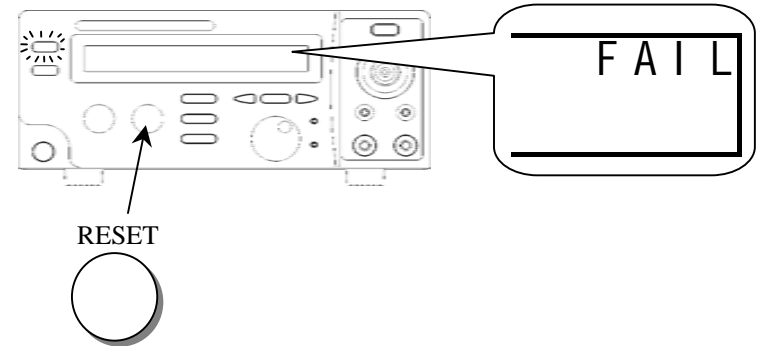

8. Use knob to view the result of group step by step.

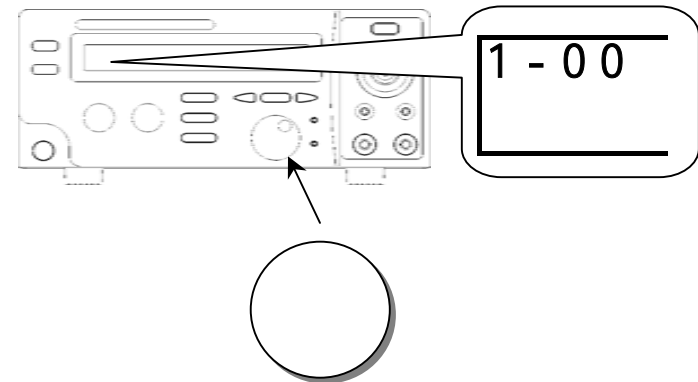



● **To View the System Utility**

1. Press the **UTILITY** key to enter status UTIL.

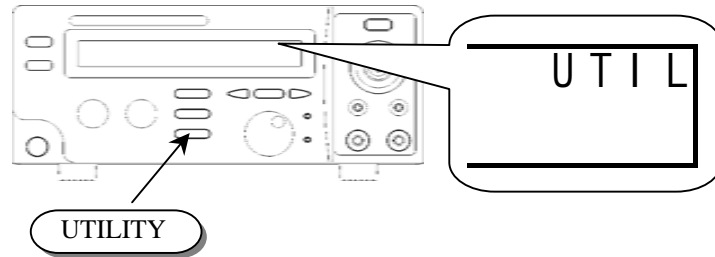

2. Use the knob or arrow keys to change the active parameter.

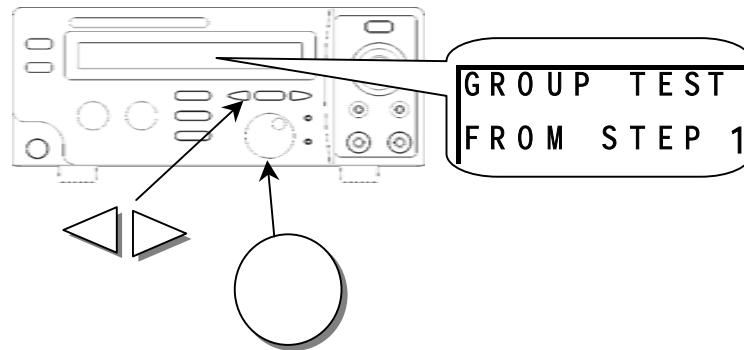

**3. Table of system utility:**

Parameter	Option	Description
<b>GROUP TEST</b>	From STEP 1	The group test procedure always begins from step 1 to end of group. e.g. 01~01
	From the present step	The group test procedure always begins from the step selected to end of group. e.g. 01~03
<b>ARC MODE</b>	DISABLE	Disable the function arc detection.
	ENABLE & STOP	Enable the arc detection and stop the test when arc is active.
	ENABLE & CONTINUE	Enable the arc detection and continue the test when arc is active.
<b>ARC CURRENT</b>		Set the current level of arc detection.
<b>AC FREQUENCY</b>	50 Hz	Set the AC hi-pot output frequency to 50 Hz.
	60 Hz	Set the AC hi-pot output frequency to 60 Hz.
<b>TEST CONTROL MODE</b>	MODE 1	Control mode of front panel. Mode 1: Reset first (press reset button before test)
	MODE 2	Mode 2: Press start button directly.
	MODE 3	Mode 3: REMOTE I/O enable (the start button is disable)
	MODE 4	Mode 4: Reserved.
<b>DATA LOCK</b>	UNLOCKED	Accept and save all parameters of test step and utility.
	LOCKED	Refuse to change any parameters of test step and utility.
<b>CONTL. CALIBRATION</b>		Calibrate the short resistance of test leads for test of Continuity check.

<b>IR TEST MODE</b>	Stop on fail	Stop on fail at the DUT detection.
	Stop on pass	Stop on pass at the DUT detection.
	Timer	Reach the time of determination for pass or fail.
<b>ZERO CHECK (GB only)</b>	Zero check by shorting the resistance of test leads only for ground bond test.	
<b>Interface</b>	RS-232 Baud Rate	1200, 2400, 4800, 9600.
	GPIB Address	00~31
<b>FAIL Setting</b>	Stop	The operation will stop upon the failure occurred at any step of group test.
	Continue	The operation will not stop until all 16 group steps has been tested.

● **To Edit/Save the System Utility**

1. Follow the above procedure “To View the System Utility” to select a parameter.
2. Press the **EDIT/SAVE** key to enter status EDIT.

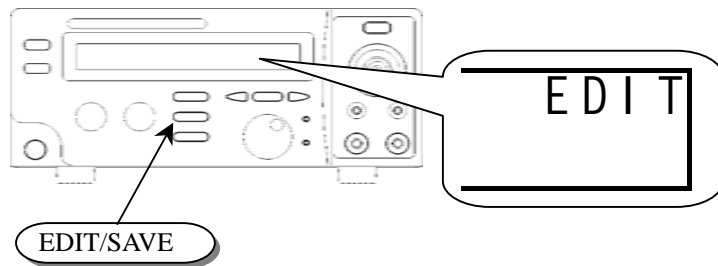

3. Use knob to adjust parameter. Use arrow keys to change knob's resolution.

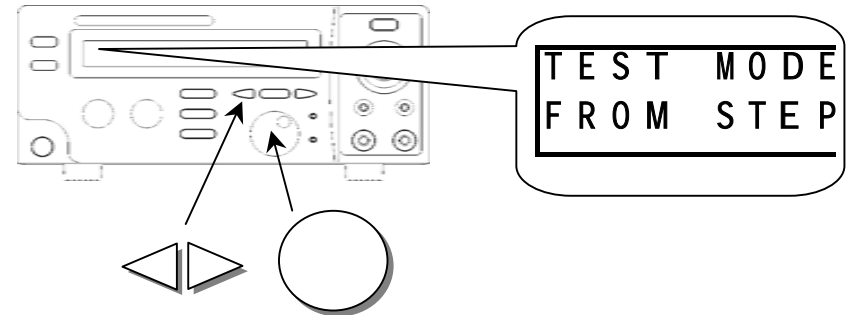

4. After setting this parameter, press **EDIT/SAVE** key to save the parameter. The status will become SAVE. After the parameter is saved, the status will return to EDIT.

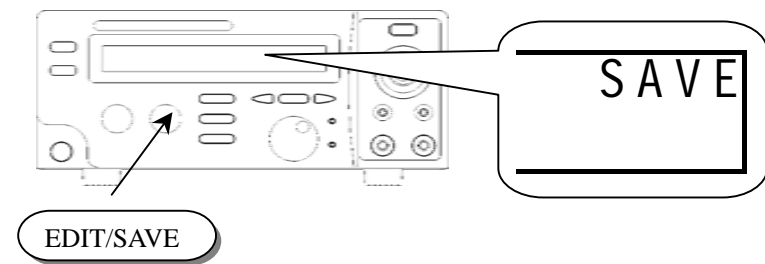

5. Repeat the procedure “To View the System Utility” to select another parameter.

### 5-3. Structure of storage steps

The storage steps of EST are total 10 groups (group 0 ~ group 9), 16 steps (step 1 ~ step 16) for each group. Except these steps, there is another step “COM” for special test. The presentation of storage steps is Group: Step. The first number represents group while the second represents step.

	Group 0	Group 1	Group 2	Group 3	Group 4	Group 5	~	Group 9
Step 1	0:1	1:1	2:1	3:1	4:1	5:1		9:1
	↓	↓	↓	↓	↓	↓		↓
Step 2	0:2	1:2	2:2	3:2	4:2	5:2		9:2
	↓	↓	↓	↓	↓	↓		↓
Step 3	0:3	1:3	2:3	3:3	4:3	5:3		9:3
	↓	↓	↓	↓	↓	↓		↓
Step 4	0:4	1:4	2:4	3:4	4:4	5:4		9:4
	↓	↓	↓	↓	↓	↓		↓
Step 5	0:5	1:5	2:5	3:5	4:5	5:5		9:5
Step 16	0:16	1:16	2:16	3:16	4:16	5:16		9:16

The special test step “COM” contains another two types of test: CAC and CDC. The function of CAC (CDC) is as same as ACW (DCW), except user could adjust the output voltage during test.

After each step has been tested, the tested status will be shown on the screen:

Step	1	2	3	4	5	6	7	8	9	0	1	2	3	4	5	6	
Test	P	P	P	P	P	P	P	P	P	P	P	P	P	P	P	P	P

- N: Empty
- P: Pass
- F: Fail
- Step 1: CH1
- Step 2: CH2
- Step 3: CH3
- Step 4: CH4
- Step 5: CH5
- Step 6: CH6
- Step 7: CH7
- Step 8: CH8
- Step 9: CH9
- Step 0: CH10
- Step 1: CH11
- Step 2: CH12
- Step 3: CH13
- Step 4: CH15
- Step 5: CH15
- Step 6: CH16

#### 5-4. Menu parameter setup

- **AC/DC withstanding voltage test (ACW, DCW— only for GPT-715A /GPI-735A/745A)**

Press MENU key to enter status MENU then use knob and arrow keys to select a step.

Press EDIT/SAVE key to enter status EDIT. Now the cursor stays at the “test mode” field. Use the knob to select mode ACW (DCW).

**Functionality of FIELD key:**

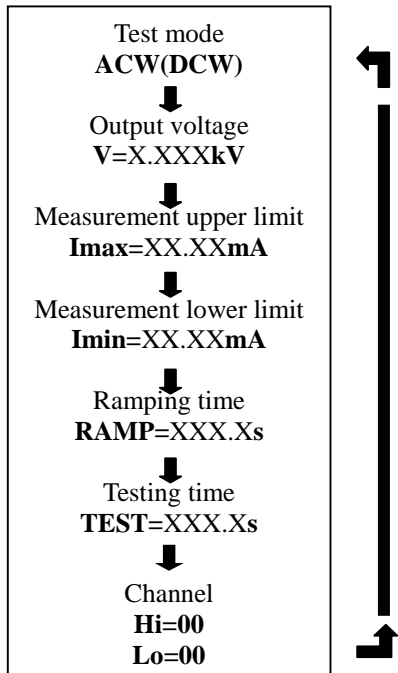

Press FIELD key to edit next field “output voltage”. Use the knob to adjust the desired output voltage while use the arrow keys to adjust the knob’s resolution (0.100~5.000kV for ACW, 0.100~6.000kV for DCW).

Press FIELD key again to enter next field “measurement upper limit”. Use the knob to adjust the desired upper limit of leakage current while use the arrow keys to adjust the knob’s resolution (0.10~40mA for ACW, 0.10~10mA for DCW).

Press FIELD key again to enter next field “measurement lower limit”. Use the knob to adjust the desired lower limit of leakage current while use the arrow keys to adjust the knob’s resolution (0.10~40mA for ACW, 0.10~10mA for DCW).

Press FIELD key again to enter next field “ramping time”. Use the knob to adjust the desired ramping time while use the arrow keys to adjust the knob’s resolution (0~999.9s).

Press FIELD key again to enter next field “testing time”. Use the knob to adjust the desired testing time while use the arrow keys to adjust the knob’s resolution (0.5~999.9s).

Press FIELD key again to return the first field “test mode” again.

Press EDIT/SAVE key to save all the parameters.

**AC/DC withstanding voltage Test Result Message**

I= “UUUUU” means the DUT current is over the metering range of ACW/DCW.

The output could be short or over 40mA(ACW) or 10mA(DCW).

- **Continuous AC/DC withstanding voltage test (CAC,CDC-only for GPT-715A/GPI-735A/745A)**

The CAC/CDC test is available only on step “0:0”. Like the traditional hi-pot tester, you can use the knob and arrow keys to adjust output voltage during test.

All the parameters of CAC/CDC are the same as ACW/DCW, except the testing time. The testing of CAC/CDC is not limited.

- **Insulation Resistance test (IR- only for GPI-725A/735A/745A)**

Press MENU key to enter status MENU then use knob and arrow keys to select a step.

Press EDIT/SAVE key to enter status EDIT. Now the cursor stays at the “test mode” field. Use the knob to select mode IR.

**Functionality of FIELD key:**

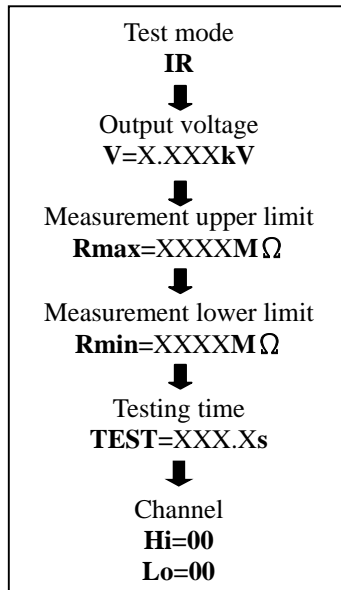

Press FIELD key to edit next field “output voltage”. Use the knob to adjust the desired output voltage (50V/100V/500V/1000V).

Press FIELD key again to enter next field “measurement upper limit”. Use the knob to adjust the desired upper limit of resistance while use the arrow keys to adjust the knob’s resolution(0~9999MΩ, 0~2000MΩ 50V/100V).

Press FIELD key again to enter next field “measurement lower limit”. Use the knob to adjust the desired lower limit of resistance while use the arrow keys to adjust the knob’s resolution(0~9999MΩ, 0~2000MΩ 50V/100V).

Press FIELD key again to enter next field “testing time”. Use the knob to adjust the desired testing time while use the arrow keys to adjust the knob’s resolution (1.0~999.9s).

Press FIELD key again to return the first field “test mode” again.

Press EDIT/SAVE key to save all the parameters.

● **Ground Bonding Test (GB- only for GPI-745A)**

Press MENU key to enter status MENU then use knob and arrow keys to select a step.

Press EDIT/SAVE key to enter status EDIT. Now the cursor stays at the “test mode” field. Use the knob to select mode GB.

**Functionality of FIELD key:**

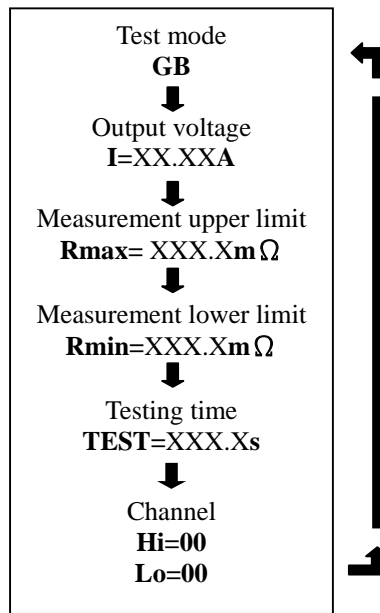

Press FIELD key to edit next field “output current”. Use the knob to adjust the desired output current (3.00~42.00A).

Press FIELD key again to enter next field “measurement upper limit”. Use the knob to adjust the desired upper limit of resistance while use the arrow keys to adjust the knob’s resolution (0~620.0mΩ).

Press FIELD key again to enter next field “measurement lower limit”. Use the knob to adjust the desired lower limit of resistance while use the arrow keys to adjust the knob’s resolution (0~620.0mΩ).

Press FIELD key again to enter next field “testing time”. Use the knob to adjust the desired testing time while use the arrow keys to adjust the knob’s resolution (0.5~999.9s).

Press FIELD key again to return the first field “test mode” again.

Press EDIT/SAVE key to save all the parameters.

When the Scanner Box is disconnected, the channel selected menu would not exist. When set channel to Hi:00 and Lo:10, the test signal is sent to the instrument only, will not be sent to scanner.

**Continuity Check (Cnt)**

Press MENU key to enter status MENU then use knob and arrow keys to select a step.

Press EDIT/SAVE key to enter status EDIT. Now the cursor stays at the “test mode” field. Use the knob to select mode Cnt. The output current is fixed to 0.100A.

**Functionality of FIELD key:**

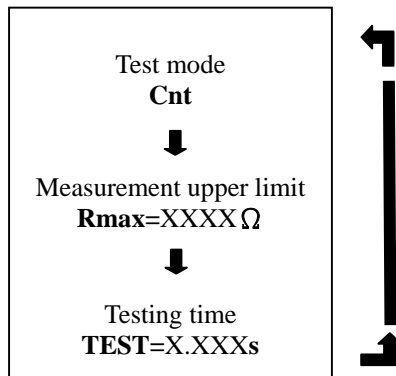

Press FIELD key to enter next field “measurement upper limit”. Use the knob to adjust the desired upper limit of resistance while use the arrow keys to adjust the knob’s resolution (0~1.200Ω).

Press FIELD key again to enter next field “testing time”. Use the knob to adjust the desired testing time while use the arrow keys to adjust the knob’s resolution (0.5~999.9s).

Press FIELD key again to return the first field “test mode” again.

Press EDIT/SAVE key to save all the parameters.

**Functionality of remote interface**

The remote interface provides two inputs (START and RESET) and three outputs (TESTING, PASS and FAIL).

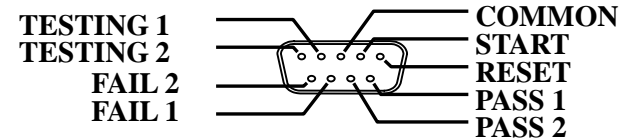

**RESET:** Connect “RESET”(pin 1) to “COMMON”(pin 3) will reset or interrupt this machine (as same as the functionality of RESET button at front panel).

**START:** In status READY, connect “TEST”(pin 2) to “COMMON”(pin 3) will start the test procedure (as same as the functionality of START button at front panel).

**TESTING 1, TESTING 2** During test, the “TESTING 1”(pin 4) and “TESTING 2”(pin 5) will be shorted.

**PASS 1, PASS 2** If the result of test is “pass”, the “PASS 1”(pin 6) and “PASS 2”(pin 7) will be shorted.

**FAIL 1, FAIL 2** If the result of test is “fail”, the “FAIL 1”(pin 8) and “FAIL 2”(pin 9) will be shorted.

*\*The max. power rating of PASS/FAIL/TESTING outputs:*

*Apply voltage: +/-300V*

*Carry current:: +/-100mA*

*Power dissipation: 400mW*

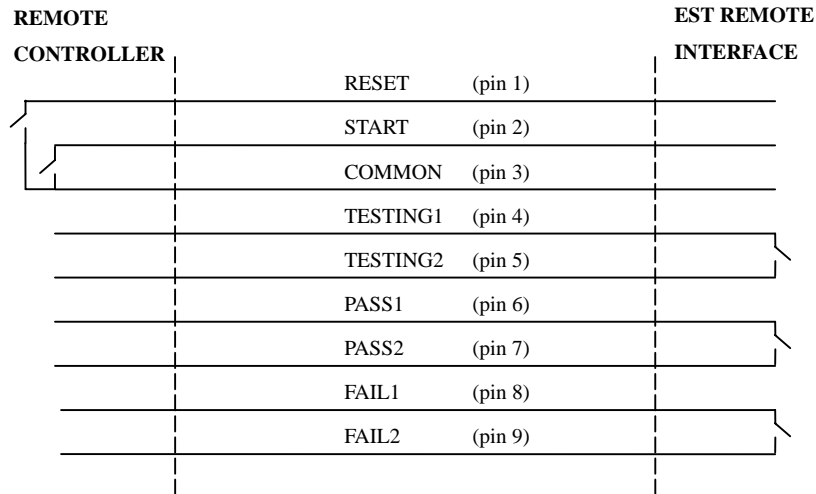

The function key of front panel can not be used when any two pins of the Reset、Start or Common function of remote control appear short circuit. Please check the remote control device.

## 6. MAINTENANCE

The following instructions are used by qualified person only to avoid electrical shock, do not perform any service other than contained in the operation instructions unless you are qualified to do so.

### 6-1. Fuse Rating and type

If the fuse blows, the product will not operate. Try to determine and correct the cause of the blown fuse, then replace the fuse with correct rating and type shown as below:

Line voltage	Range	Fuse	Line voltage	Range	Fuse
100V	90-110V	T 7.0A	220V	198-242V	T4A
120V	108-132V	250V	230V	207-250V	250V



**WARNING: For continued fire protection, replace only with 250V fuse of the specified type and rating, and disconnect the power cord before proceeding fuse replacement.**

### 6-2. Cleaning

To keep the instrument clean, wipe the case with a damp cloth and detergent. Do not use abrasives or solvents.





## Artisan Technology Group is your source for quality new and certified-used/pre-owned equipment

- FAST SHIPPING AND DELIVERY
- TENS OF THOUSANDS OF IN-STOCK ITEMS
- EQUIPMENT DEMOS
- HUNDREDS OF MANUFACTURERS SUPPORTED
- LEASING/MONTHLY RENTALS
- ITAR CERTIFIED SECURE ASSET SOLUTIONS

### SERVICE CENTER REPAIRS

Experienced engineers and technicians on staff at our full-service, in-house repair center

### *InstraView*<sup>SM</sup> REMOTE INSPECTION

Remotely inspect equipment before purchasing with our interactive website at [www.instraview.com](http://www.instraview.com) ↗

### WE BUY USED EQUIPMENT

Sell your excess, underutilized, and idle used equipment. We also offer credit for buy-backs and trade-ins. [www.artisanng.com/WeBuyEquipment](http://www.artisanng.com/WeBuyEquipment) ↗

### LOOKING FOR MORE INFORMATION?

Visit us on the web at [www.artisanng.com](http://www.artisanng.com) ↗ for more information on price quotations, drivers, technical specifications, manuals, and documentation

**Contact us:** (888) 88-SOURCE | [sales@artisanng.com](mailto:sales@artisanng.com) | [www.artisanng.com](http://www.artisanng.com)