



Artisan Technology Group is your source for quality new and certified-used/pre-owned equipment

- FAST SHIPPING AND DELIVERY
- TENS OF THOUSANDS OF IN-STOCK ITEMS
- EQUIPMENT DEMOS
- HUNDREDS OF MANUFACTURERS SUPPORTED
- LEASING/MONTHLY RENTALS
- ITAR CERTIFIED SECURE ASSET SOLUTIONS

SERVICE CENTER REPAIRS

Experienced engineers and technicians on staff at our full-service, in-house repair center

*InstraView*SM REMOTE INSPECTION

Remotely inspect equipment before purchasing with our interactive website at www.instraview.com ↗

WE BUY USED EQUIPMENT

Sell your excess, underutilized, and idle used equipment. We also offer credit for buy-backs and trade-ins. www.artisanng.com/WeBuyEquipment ↗

LOOKING FOR MORE INFORMATION?

Visit us on the web at www.artisanng.com ↗ for more information on price quotations, drivers, technical specifications, manuals, and documentation

Contact us: (888) 88-SOURCE | sales@artisanng.com | www.artisanng.com

**SYSMAC
C200H-OV001**

Voice Unit

OPERATION MANUAL

OMRON

C200H-OV001 Voice Unit

Operation Manual

Revised September 2000

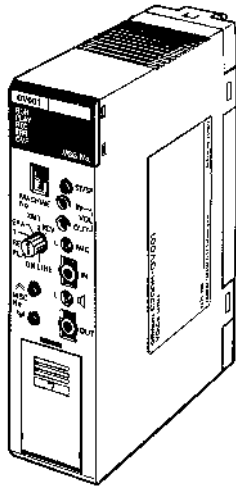



Notice:

OMRON products are manufactured for use according to proper procedures by a qualified operator and only for the purposes described in this manual.

The following conventions are used to indicate and classify precautions in this manual. Always heed the information provided with them. Failure to heed precautions can result in injury to people or damage to property.

 **DANGER** Indicates an imminently hazardous situation which, if not avoided, will result in death or serious injury.

 **WARNING** Indicates a potentially hazardous situation which, if not avoided, could result in death or serious injury.

 **Caution** Indicates a potentially hazardous situation which, if not avoided, may result in minor or moderate injury, or property damage.

OMRON Product References

All OMRON products are capitalized in this manual. The word “Unit” is also capitalized when it refers to an OMRON product, regardless of whether or not it appears in the proper name of the product.

The abbreviation “Ch,” which appears in some displays and on some OMRON products, often means “word” and is abbreviated “Wd” in documentation in this sense.

The abbreviation “PC” means Programmable Controller and is not used as an abbreviation for anything else.

Visual Aids

The following headings appear in the left column of the manual to help you locate different types of information.

Note Indicates information of particular interest for efficient and convenient operation of the product.

Reference Indicates supplementary information on related topics that may be of interest to the user.

1, 2, 3... 1. Indicates lists of one sort or another, such as procedures, checklists, etc.

© OMRON, 1989

All rights reserved. No part of this publication may be reproduced, stored in a retrieval system, or transmitted, in any form, or by any means, mechanical, electronic, photocopying, recording, or otherwise, without the prior written permission of OMRON.

No patent liability is assumed with respect to the use of the information contained herein. Moreover, because OMRON is constantly striving to improve its high-quality products, the information contained in this manual is subject to change without notice. Every precaution has been taken in the preparation of this manual. Nevertheless, OMRON assumes no responsibility for errors or omissions. Neither is any liability assumed for damages resulting from the use of the information contained in this publication.

About this Manual:

This manual is an Operation Manual for OMRON's C200H Voice Unit. The information included in this manual covers everything from system configuration and operation details to example PC programs suited to the Voice Unit's wide range of uses. A brief description of the contents of this manual is as follows:

Section 1 provides an introduction to the Voice Unit, including nomenclature and functions, details concerning the system configuration of the Voice Unit and the various input and output connections that can be made to the Voice Unit (microphones, speakers, and the types of jacks and plugs that may be required for the connecting devices).

Section 2 outlines the specifics concerning data allocation in relation to both how many words of data the Voice Unit requires when connected to the PC and also specifically which words in the PC's AR area are assigned to the Voice Unit (depending on the slot to which it is mounted).

Section 3 details the operation of the Voice Unit and includes the Voice Unit's preliminary DIP switch settings; operation procedure; message recording, playback, erasure, transfer, etc. ; PC-controlled message playback; and finally how to set up multiple Voice Unit configurations.

Section 4 provides a long list of example programs that can be programmed on a PC to control the Voice Unit. The programs are listed with comments and require a working knowledge of ladder diagram programming.

Section 5 outlines concisely the various error conditions the Voice Unit may display and how they can be corrected or avoided.

Appendices A, B, and C respectively, provide information on the Voice Unit's maintenance, troubleshooting, and specifications as well as the standard Voice Unit models.

This manual describes the characteristics and abilities of the C200H Voice Unit, as well as the aspects of operation and preparation that demand attention. Before attempting to operate the Voice Unit, thoroughly familiarize yourself with the information that follows.



WARNING Failure to read and understand the information provided in this manual may result in personal injury or death, damage to the product, or product failure. Please read each section in its entirety and be sure you understand the information provided in the section and related sections before attempting any of the procedures or operations given.

TABLE OF CONTENTS

PRECAUTIONS	vii
1 Intended Audience	viii
2 General Precautions	viii
3 Safety Precautions	viii
4 Operating Environment Precautions	ix
5 Application Precautions	ix
SECTION 1 – Introduction	1
1-1 Nomenclature and Functions	2
1-2 System Configuration	7
1-3 Input/Output Device Connections	8
SECTION 2 – Data Area Allocation	13
2-1 Data Areas	14
2-2 Bit Number Allocation	14
SECTION 3 – Operation	19
3-1 Preliminary Settings	20
3-2 Operating Procedure	21
3-3 REC Mode	22
3-4 PLAY Mode	25
3-5 ERASE Mode	27
3-6 TIME Mode	32
3-7 XMT/RCV Mode	33
3-8 ON-LINE Mode	38
3-9 Operations in ON-LINE Mode	56
3-10 Mixing Function	57
SECTION 4 – Example Programs	59
4-1 Sentence Mode Example Programs	60
4-2 Phrase Combination Mode Example Programs	65
SECTION 5 – Troubleshooting	79
5-1 Error Codes	80
5-2 Troubleshooting	85
Appendix	87
A – Inspection and Maintenance	87
B – Specifications	89
C – Standard Models	91
Glossary	93
Index	95

PRECAUTIONS

This section provides general precautions for using the Programmable Controller (PC) and related devices.

The information contained in this section is important for the safe and reliable application of the Programmable Controller. You must read this section and understand the information contained before attempting to set up or operate a PC system.

1	Intended Audience	viii
2	General Precautions	viii
3	Safety Precautions	viii
4	Operating Environment Precautions	ix
5	Application Precautions	ix

1 Intended Audience

This manual is intended for the following personnel, who must also have knowledge of electrical systems (an electrical engineer or the equivalent).

- Personnel in charge of installing FA systems.
- Personnel in charge of designing FA systems.
- Personnel in charge of managing FA systems and facilities.

2 General Precautions

The user must operate the product according to the performance specifications described in the relevant manuals.

Before using the product under conditions which are not described in the manual or applying the product to nuclear control systems, railroad systems, aviation systems, vehicles, combustion systems, medical equipment, amusement machines, safety equipment, and other systems, machines, and equipment that may have a serious influence on lives and property if used improperly, consult your OMRON representative.

Make sure that the ratings and performance characteristics of the product are sufficient for the systems, machines, and equipment, and be sure to provide the systems, machines, and equipment with double safety mechanisms.

This manual provides information for programming and operating the Unit. Be sure to read this manual before attempting to use the Unit and keep this manual close at hand for reference during operation.

 **WARNING** It is extremely important that a PC and all PC Units be used for the specified purpose and under the specified conditions, especially in applications that can directly or indirectly affect human life. You must consult with your OMRON representative before applying a PC system to the above-mentioned applications.



3 Safety Precautions

 **WARNING** Do not attempt to take any Unit apart while the power is being supplied. Doing so may result in electric shock.

 **WARNING** Do not touch any of the terminals or terminal blocks while the power is being supplied. Doing so may result in electric shock.



 **WARNING** Do not attempt to disassemble, repair, or modify any Units. Any attempt to do so may result in malfunction, fire, or electric shock.

4 Operating Environment Precautions

-  **Caution** Do not operate the control system in the following locations:
- Locations subject to direct sunlight.
 - Locations subject to temperatures or humidity outside the range specified in the specifications.
 - Locations subject to condensation as the result of severe changes in temperature.
 - Locations subject to corrosive or flammable gases.
 - Locations subject to dust (especially iron dust) or salts.
 - Locations subject to exposure to water, oil, or chemicals.
 - Locations subject to shock or vibration.
-  **Caution** Take appropriate and sufficient countermeasures when installing systems in the following locations:
- Locations subject to static electricity or other forms of noise.
 - Locations subject to strong electromagnetic fields.
 - Locations subject to possible exposure to radioactivity.
 - Locations close to power supplies.
-  **Caution** The operating environment of the PC system can have a large effect on the longevity and reliability of the system. Improper operating environments can lead to malfunction, failure, and other unforeseeable problems with the PC system. Be sure that the operating environment is within the specified conditions at installation and remains within the specified conditions during the life of the system.

5 Application Precautions

Observe the following precautions when using the PC system.

-  **WARNING** Always heed these precautions. Failure to abide by the following precautions could lead to serious or possibly fatal injury.
- Always ground the system to 100 Ω or less when installing the Units. Not connecting to a ground of 100 Ω or less may result in electric shock.
 - Always turn OFF the power supply to the PC before attempting any of the following. Not turning OFF the power supply may result in malfunction or electric shock.
 - Mounting or dismounting Power Supply Units, I/O Units, CPU Units, Memory Units, or any other Units.
 - Assembling the Units.
 - Setting DIP switches or rotary switches.
 - Connecting cables or wiring the system.
 - Connecting or disconnecting the connectors.
-  **Caution** Failure to abide by the following precautions could lead to faulty operation of the PC or the system, or could damage the PC or PC Units. Always heed these precautions.
- Fail-safe measures must be taken by the customer to ensure safety in the event of incorrect, missing, or abnormal signals caused by broken signal lines, momentary power interruptions, or other causes.

- Interlock circuits, limit circuits, and similar safety measures in external circuits (i.e., not in the Programmable Controller) must be provided by the customer.
- Always use the power supply voltages specified in this manual. An incorrect voltage may result in malfunction or burning.
- Take appropriate measures to ensure that the specified power with the rated voltage and frequency is supplied. Be particularly careful in places where the power supply is unstable. An incorrect power supply may result in malfunction.
- Install external breakers and take other safety measures against short-circuiting in external wiring. Insufficient safety measures against short-circuiting may result in burning.
- Do not apply voltages to the Input Units in excess of the rated input voltage. Excess voltages may result in burning.
- Do not apply voltages or connect loads to the Output Units in excess of the maximum switching capacity. Excess voltage or loads may result in burning.
- Disconnect the functional ground terminal when performing withstand voltage tests. Not disconnecting the functional ground terminal may result in burning.
- Be sure that all the mounting screws, terminal screws, and cable connector screws are tightened to the torque specified in this manual. Incorrect tightening torque may result in malfunction.
- Leave the label attached to the Unit when wiring. Removing the label may result in malfunction if foreign matter enters the Unit.
- Remove the label after the completion of wiring to ensure proper heat dissipation. Leaving the label attached may result in malfunction.
- Double-check all wiring and switch settings before turning ON the power supply. Incorrect wiring may result in burning.
- Wire correctly. Incorrect wiring may result in burning.
- Mount Units only after checking terminal blocks and connectors completely.
- Be sure that the terminal blocks, Memory Units, expansion cables, and other items with locking devices are properly locked into place. Improper locking may result in malfunction.
- Check the user program for proper execution before actually running it on the Unit. Not checking the program may result in an unexpected operation.
- Confirm that no adverse effect will occur in the system before attempting any of the following. Not doing so may result in an unexpected operation.
 - Changing the operating mode of the PC.
 - Force-setting/force-resetting any bit in memory.
 - Changing the present value of any word or any set value in memory.
- Resume operation only after transferring to the new CPU Unit the contents of the DM Area, HR Area, and other data required for resuming operation. Not doing so may result in an unexpected operation.
- Do not pull on the cables or bend the cables beyond their natural limit. Doing either of these may break the cables.
- Do not place objects on top of the cables or other wiring lines. Doing so may break the cables.
- Use crimp terminals for wiring. Do not connect bare stranded wires directly to terminals. Connection of bare stranded wires may result in burning.
- When replacing parts, be sure to confirm that the rating of a new part is correct. Not doing so may result in malfunction or burning.
- Before touching a Unit, be sure to first touch a grounded metallic object in order to discharge any static built-up. Not doing so may result in malfunction or damage.

SECTION 1

Introduction

OMRON's C200H Voice Unit is ideal for situations requiring voiced instructions or voiced warnings. The C200H Voice Unit allows the user to record up to 60 messages of varying length (64, 48, 32 through 00 seconds) and play them back as either individual complete messages (sentence mode) or intermixed (phrase mode) to form combined messages that vary with the control situation specified. Message recording can be done via a microphone connected directly to the Voice Unit, or messages can be prerecorded on magnetic tape and transferred to the Voice Unit. Message output can be either via the Voice Unit's built-in speaker or via an amplifier to a speaker. Messages stored in the Voice Unit's memory can be transferred to a computer or PROM Writer for back-up. The Voice Unit can be operated manually or programmed to run automatically via PC program control.

1-1	Nomenclature and Functions	2
1-2	System Configuration	7
1-3	Input/Output Device Connections	8

1-1 Nomenclature and Functions

Front Panel

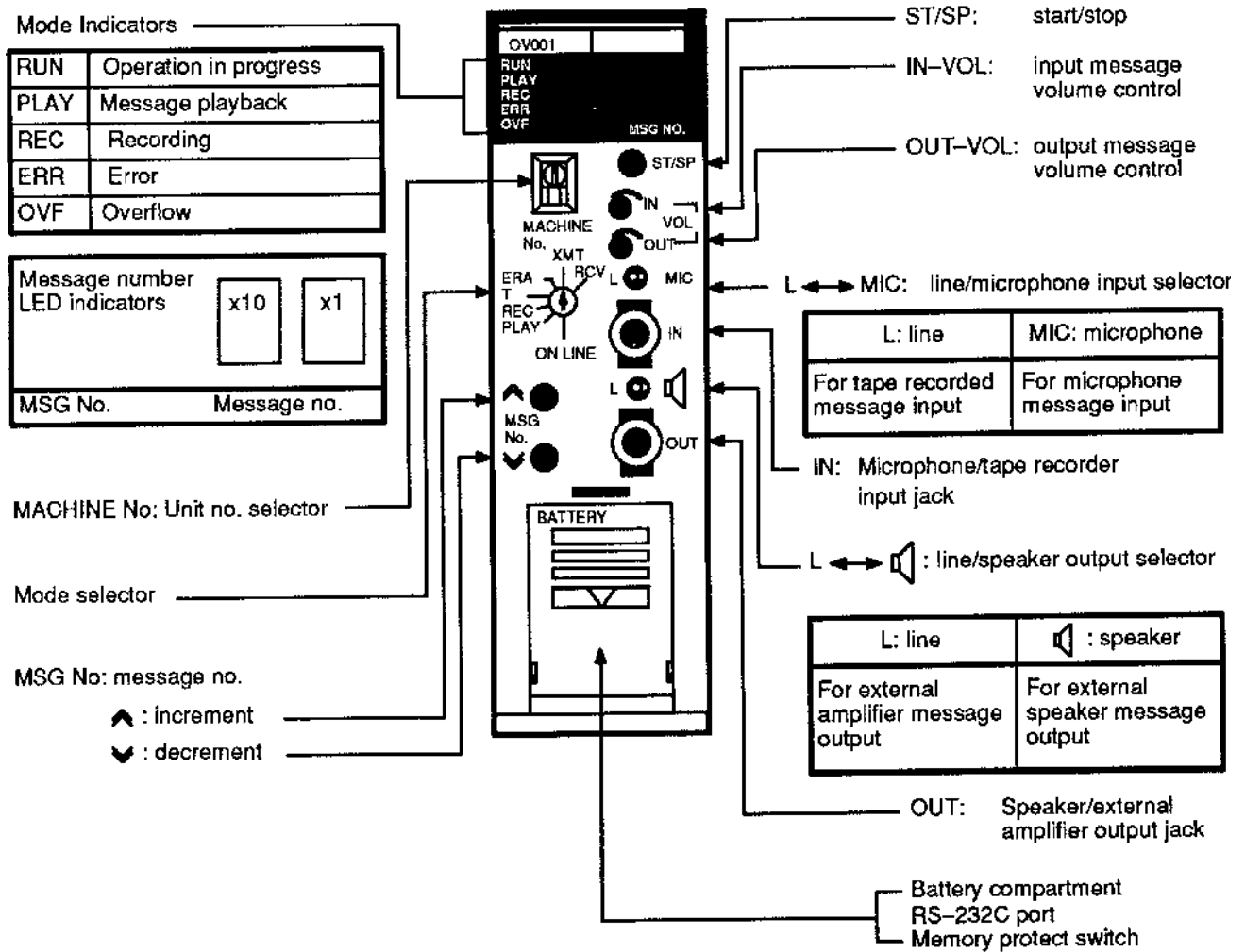

Battery Compartment

Cover Removal

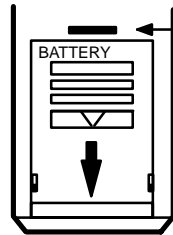

Cover catch

To remove the battery compartment cover, slide the cover down in the direction indicated by the arrow. To attach the cover, push it up in the reverse direction, until the cover catch slides into place.

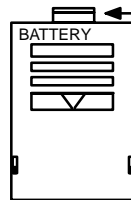

catch

Battery compartment cover

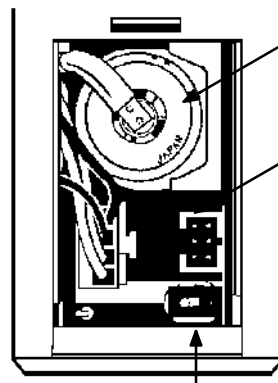

Battery model no:
C200H-BAT09

RS-232C Port

For message transfer to a computer, or PROM Writer.





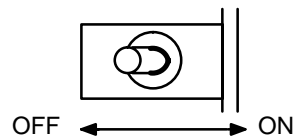





Memory protect switch





Battery connection



OFF	ON
Messages can be written to memory.	Writing of data to memory is inhibited. Be sure to turn this switch ON to protect data (recorded messages) after messages have been recorded.



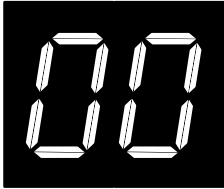
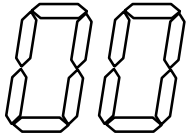

Indicators

Indicator	Indication	Conditions
RUN (green)		Lit if Unit is operating without error. Unlit when there is a PC communication error.
PLAY (green)		Lit during message playback or message erasure.
		Blinking (at 0.5 second intervals) indicates that REC or ERA mode is ready to operate.
		Blinking (at 0.2 second intervals) indicates that XMT (transmit) mode is ready to operate.
REC (red)		Lit during message input (recorded) or erasure.
		Blinking (at 0.5 second intervals) indicates that REC or ERA mode is ready to operate.
		Blinking (at 0.2 second intervals) indicates that RCV (receive) mode is ready to operate.
ERR (red)		Lit when an error occurs (such as memory failure) (For details, refer to 5-2 Troubleshooting.)
		Blinking (at 0.2 second intervals) indicates that the battery supply voltage is low or that the battery is not connected.
		Blinking at high speed during message transmission.
OVF (red)		Lit when the input level exceeds 80% of the permissible value during message recording. Lit also when message recording mode is ready to operate.

Note  : lit,  : blinking at 0.5 s intervals,  : blinking at 0.2 s intervals,  : blinking at high speed

LED display modes	Indication	Function
MSG No. (red)	 <p>Lit</p>	<p>Displays the message number currently valid when in ON LINE, PLAY, REC, and ERA modes (ON LINE/REC: 01 through 60, PLAY/ERA: 00 through 60)</p> <p>Displays the current communication mode such as the baud rate in XMT or RCV mode etc. (left digit: 0 through 7, right digit: 0 through 5)</p>
	 <p>Blinking</p>	<p>Displays the recording time remaining when in TIME mode. (64/48/32 through 00 seconds possible depending on recording time)</p>

Switches, Controls, and Jacks

Switches and controls		Function
MACHINE No.		Sets the Voice Unit system configuration unit number to any integer between 0 and 9. Do not set the unit number to the same as that of another Special I/O Unit in the configuration. If this is done an "I/O UNIT OVER" error will occur. Note 1. Before setting this switch, be sure to turn OFF the PC power. 2. Set this switch with a standard screwdriver and be sure to set the switch completely.
Mode Selector	ON LINE	Voice Unit operation is controlled by the PC.
	PLAY	Recorded message playback mode.
	REC	Message recording mode.
	T	Remaining recording time display mode. The remaining time is displayed on the MSG No. indicator LEDs.
	ERA	Recorded message erasure mode.
	XMT	Recorded message transmission mode. Transmission to external devices (FIT etc.) via the RS-232C link.
	RCV	Message receive mode: from external devices (FIT etc.) via the RS-232C link.
MSG No. 		Pressing this button once increments the message no. by one (holding this button down causes the message no. to increment successively).
MSG No. 		Pressing this button once decrements the message no. by one (holding this button down causes the message no. to decrement successively).
ST/SP		Starts and stops operations in PLAY, REC, ERA, XMT, and RCV modes.
IN-VOL		Adjusts the microphone or tape recorder message input volume level. Turn clockwise to increase the volume and counterclockwise to decrease the volume. Use a screwdriver to adjust.
OUT-VOL		Adjusts the speaker message the output volume level. Turn clockwise to increase the volume and counterclockwise to decrease the volume. Use a screwdriver to adjust.
L  MIC		Selects input message source. Set to L to input messages from a tape recorder and to MIC to input messages from a microphone.
IN		Microphone or tape recorder input jack (designed for a 3.5 mm mini-plug).
L  		Selects output device. Set to L to output messages to an external amplifier and to the speaker symbol to output messages to a speaker.
OUT		External amplifier or speaker output jack (designed for a 3.5 mm mini-plug).

Back Panel

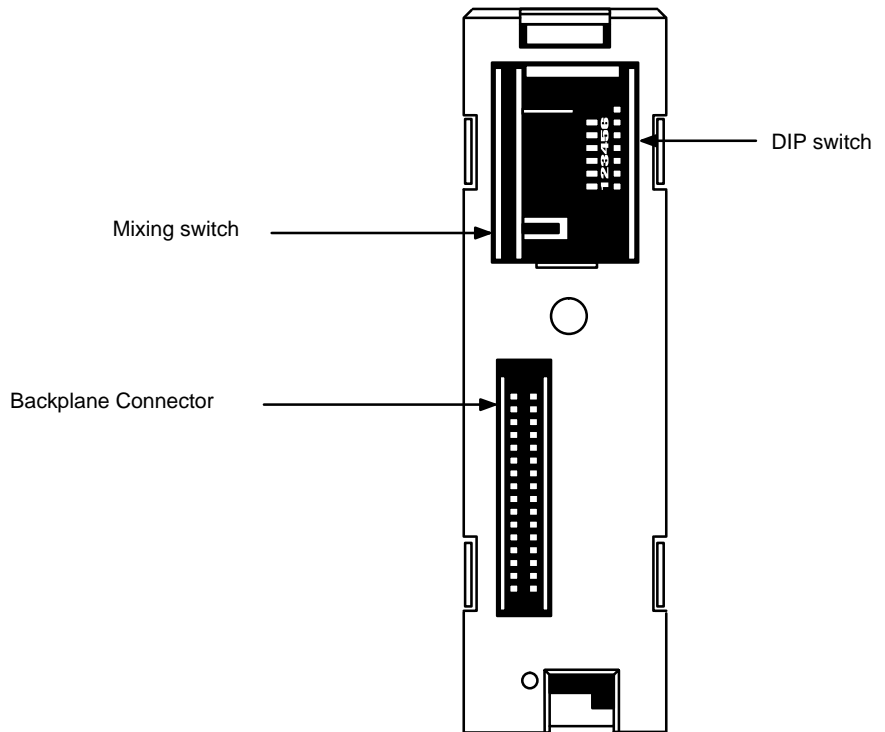

DIP Switch Settings

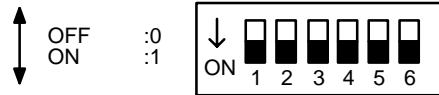

Message output mode

Pin no.	1	Function
Setting	0	Phrase combination mode
	1	Sentence mode

Output operation mode

Pin no.	2	Function
Setting	0	One-shot operation
	1	Level operation

Note This switch setting is effective in sentence mode only (i.e., when pin 1 is set to 1).

Recording time

Pin no.	5	6	Function
Setting	0	0	64 seconds
	1	0	48 seconds
	0	1	32 seconds
	1	1	Unused

Note Make sure that the actual recording time is identical to the recording time set by this switch. Failure to do this degrades the sound quality of the recorded messages.

This pin is not used. Set it to the OFF position.

Priority mode

Pin no.	3	Function
Setting	0	Sequential mode
	1	Priority mode

Note This switch setting is effective in sentence mode only (i.e., when pin 1 is set to 1).

Mixing Switch

ON ← → OFF

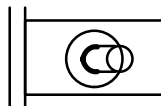

ON	OFF
Mixing enabled	Mixing disabled

Set this switch to the OFF position when the mixing function is not used.

1-2 System Configuration

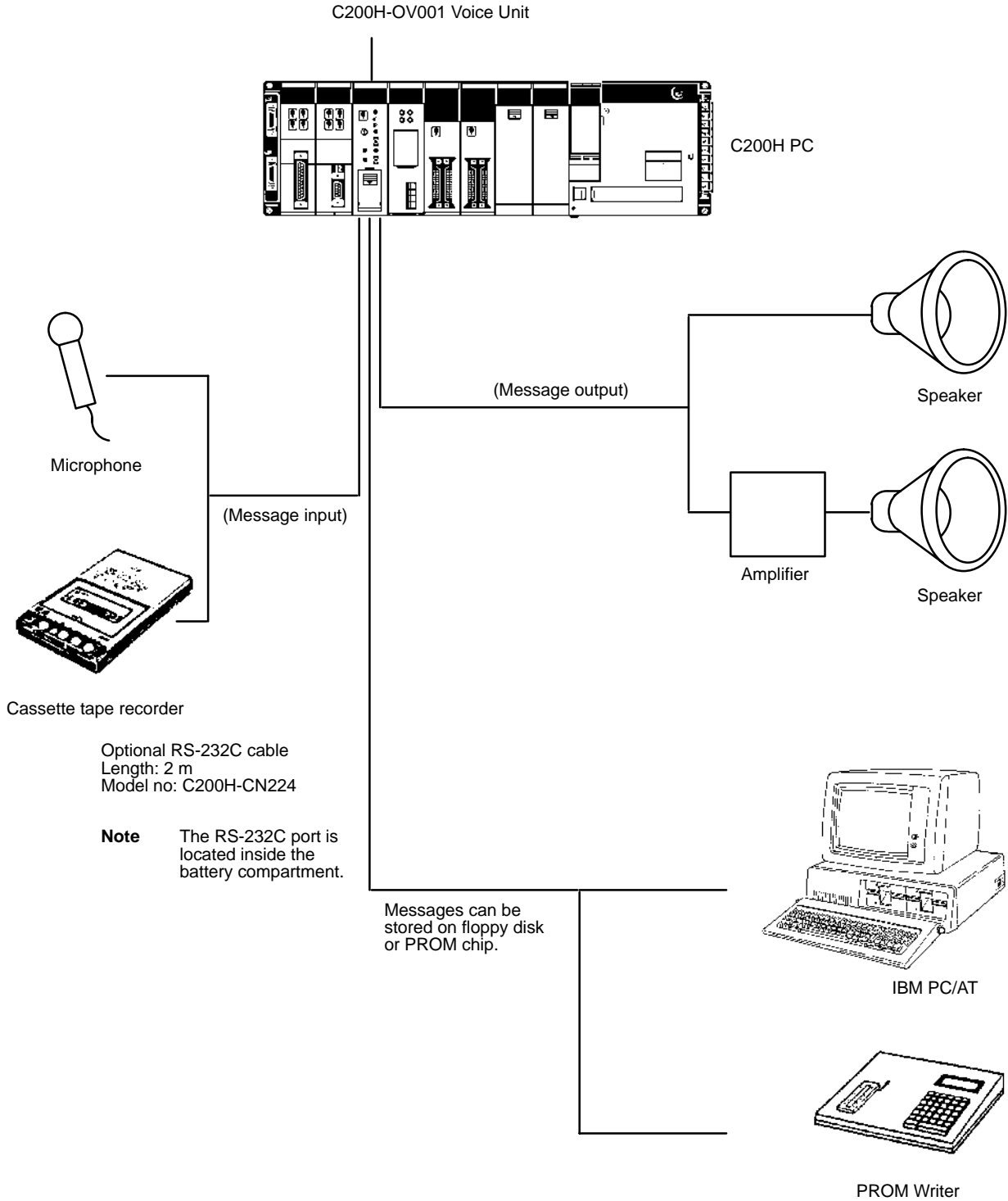

Connection to the CPU Rack and Expansion I/O Rack

The C200H-OV001 Voice Unit is a Special I/O Unit for the C200H Programmable Controller (PC), and can be mounted to any slot on the CPU Rack, Expansion I/O Rack, or Remote I/O Slave Rack of the PC. Do not mount the Voice Unit on the two right-most slots of the CPU Rack as these slots are reserved for the Programming Console.

In general up to 10 Special I/O Units (including a PC Link Unit) can be connected to one PC system. However, the total number of Units that can be

connected varies depending on the total current consumed by those Units. For details, refer to the C200H Installation Guide.

As shown in the following table, the number of Units that can be mounted to a Remote I/O Slave Rack is limited not only by current consumption, but also by the volume of data to be transferred.

CS1-series and C200HX/HG/HE(-Z) PCs

The C200H-OV001 Voice Unit cannot be used with a CS1-series or C200HX/HG/HE(-Z) PC if an OMRON operator interface (Programmable Terminal) is connected to the peripheral port or RS-232C port via NT Link. Take the following countermeasures.

- **CS1 Series PCs**
Use a CS1W-SCB□□/SCU□□, and connect the Programmable Terminal to its serial communications port.
- **C200HX/HG/HE(-Z) PCs**
Use a C200HW-COM□□, and connect the Programmable Terminal to its serial communications port.

When using the C200H-OV001 Voice Unit, the baud rate for the peripheral port or the RS-232C port must not exceed 9,600 bps (regardless of the serial communications mode).

Limits on Remote I/O Slave Rack Mounting

The number of Special I/O Units that can be mounted to a Remote I/O Slave Rack is as shown in the following table.

The figures in the table apply only when no Special I/O Unit is mounted to other Racks (i.e., CPU and Expansion I/O Racks) and only when Units belonging to each of groups A, B, C, and D are mounted to a Remote I/O Slave Rack.

A	B	C	D
High-speed Counter Units, Position Control Units (NC111/NC112), ASCII Units, Analog I/O Units, ID Sensor Units	Multi-point I/O Units	Voice and Temperature Sensor Units	Position Control Units (NC211)
4 max.	---	---	---
---	8 max.	---	---
---	---	6 max.	---
---	---	---	2 max.

- Note**
1. When units from groups A, B, C, and D are used in combination, the following relations must be satisfied:

$$3A + B + 2C + 6D < 12$$

$$A + B + C + D < 8$$
 2. A maximum of 10 Units can be mounted to a Remote I/O Slave Rack. However, the NC211 Position Control Unit counts as two Units and if a PC Link Unit is used, it must be counted as one Unit.

1-3 Input/Output Device Connections

Message Input Jack Connection

The Voice Unit can be connected to either a dynamic microphone or cassette tape recorder via the message input jack.

Connection Advantages and Instructions

Message recording via a microphone is simpler than using a cassette tape recorder, however the quality of tape-recorded messages is higher.

Microphone Recordings For microphone recordings set the L ↔ MIC selector switch to MIC and then connect the microphone to the message input jack using an unbalanced mini-plug (mini-plug dia. 3.5 mm).

Tape Recorder Recordings For recordings on cassette tape, set the L ↔ MIC selector switch to L. After sending the message on tape, connect the external output terminal or monitor terminal of the tape recorder to the message input jack of the Voice Unit.

Jack and Plug Mismatches If your microphone or tape recorder uses a 6.34 mm diameter unbalanced phone plug or your tape recorder has a balanced stereo output refer to the diagrams below in order to make the correct conversion to a 3.5 mm diameter plug.

Plug Size Conversion (3.5 mm to 6.34 mm plug diameter)

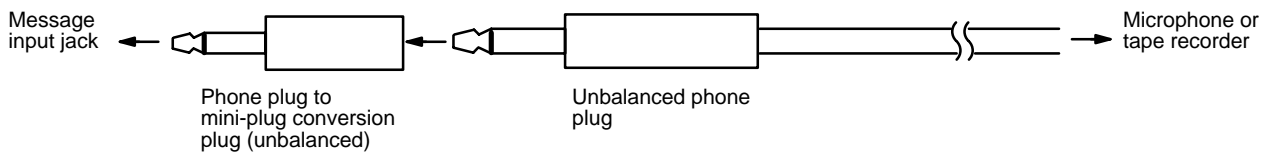

Balanced (stereo) to Unbalanced Plug Conversion

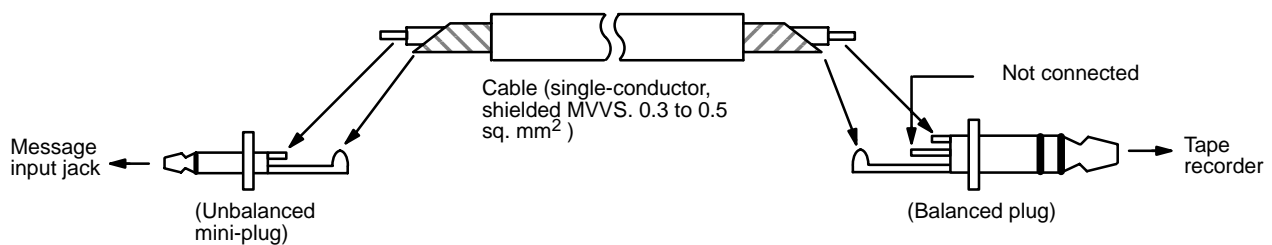

Message Output Jack Connection Either an 8 Ω speaker or amplifier (600 Ω min.) can be connected to the message output jack of the Voice Unit.

Connection Advantages and Instructions If a low message output volume is required connect a speaker directly to the message output jack and set the Voice Unit front panel line/speaker switch to the speaker symbol.

To amplify the message output volume or make more than one speaker connection, connect an external amplifier to the message output jack. Both balanced and unbalanced amplifiers can be connected, however a balanced amplifier is recommended for better sound quality and because the overall interconnection cable length is longer. Set the line/speaker selector switch to L when connecting to an amplifier.

Speaker and Amplifier Connections and Wiring

Speaker Connection

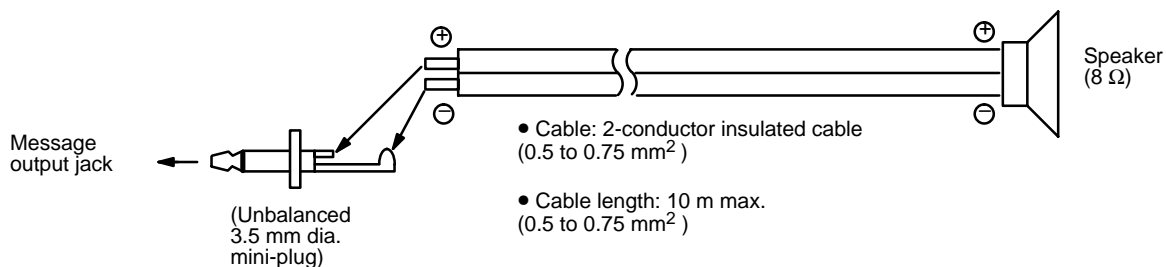

Unbalanced Amplifier Connection

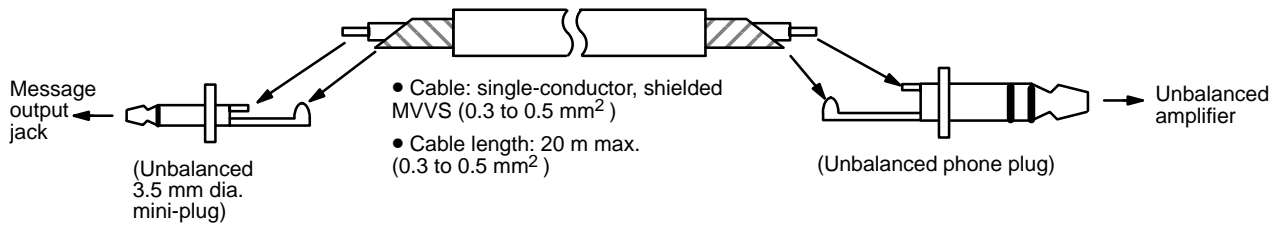

Balanced Amplifier Connection

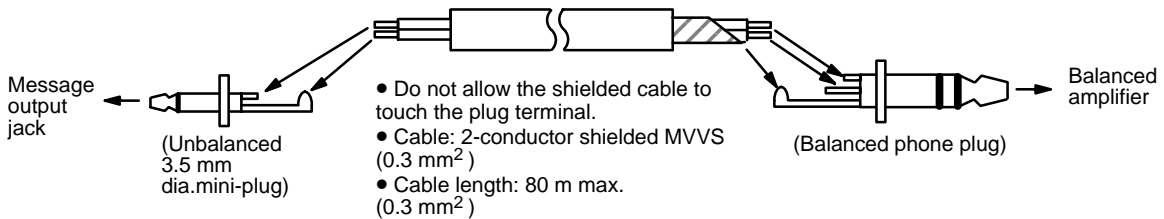

Wiring

- Separate the speaker and amplifier cables from the power cables.
- Make sure that the output specifications of external devices match the Voice Unit specifications.
- When connecting an amplifier or speaker, check the devices respective specifications: the ratings and functions of the amplifier and speakers may vary for different applications.

Note The Voice Unit is supplied with one accessory unbalanced mini-plug (3.5 mm diameter).

RS- 232C Port Pin Specifications

The Voice Unit is equipped with an RS-232C port which allows connection to a computer, or PROM Writer for the purpose of storing messages.

Connector Pin No. and Signal Name

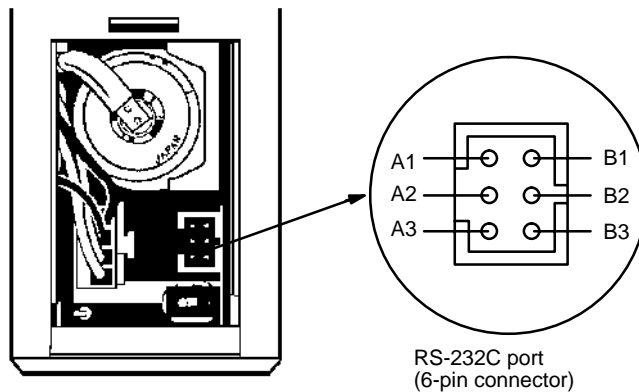

Pin No.	Signal	Signal Name	I/O
A1	SD	Send data	Output
A2	RTS	Request to send	Output
A3	FG	Frame ground	---
B1	RD	Receive data	Input
B2	CTS	Clear to send	Input
B3	SG	Signal ground	---

The electrical characteristics of the port conform to EIA RS-232C standards.

Max. cable length: 15 m max.

RS-232C Cable Connector Pin Specifications

Cable Model: C200H-CN224 (the 6-pin to 25-pin conversion cable is optional)

Cable Length: 2 m

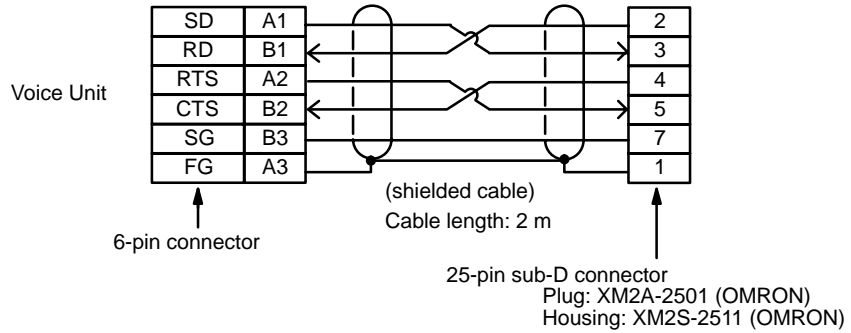

Note When connecting a peripheral device (PROM Writer etc.) to the Voice Unit, refer to the manual of the peripheral device for connection details.

SECTION 2

Data Area Allocation

2-1	Data Areas	14
2-2	Bit Number Allocation	14

2-1 Data Areas

The Voice Unit is allocated either 6 or 10 words (6 for sentence mode, 10 for phrase mode) of the PC's IR area (word 100 through 199). For details on the IR area refer to the C200H operation manual.

Message mode	I/O area word allocation
Sentence mode	6 words
Phrase combination mode	10 words

When the Voice Unit is used in sentence mode only 6 of the 10 available IR bits are used, the remaining four bits can be used as ordinary IR bits. For details on the IR area refer to the C200H operation Manual.

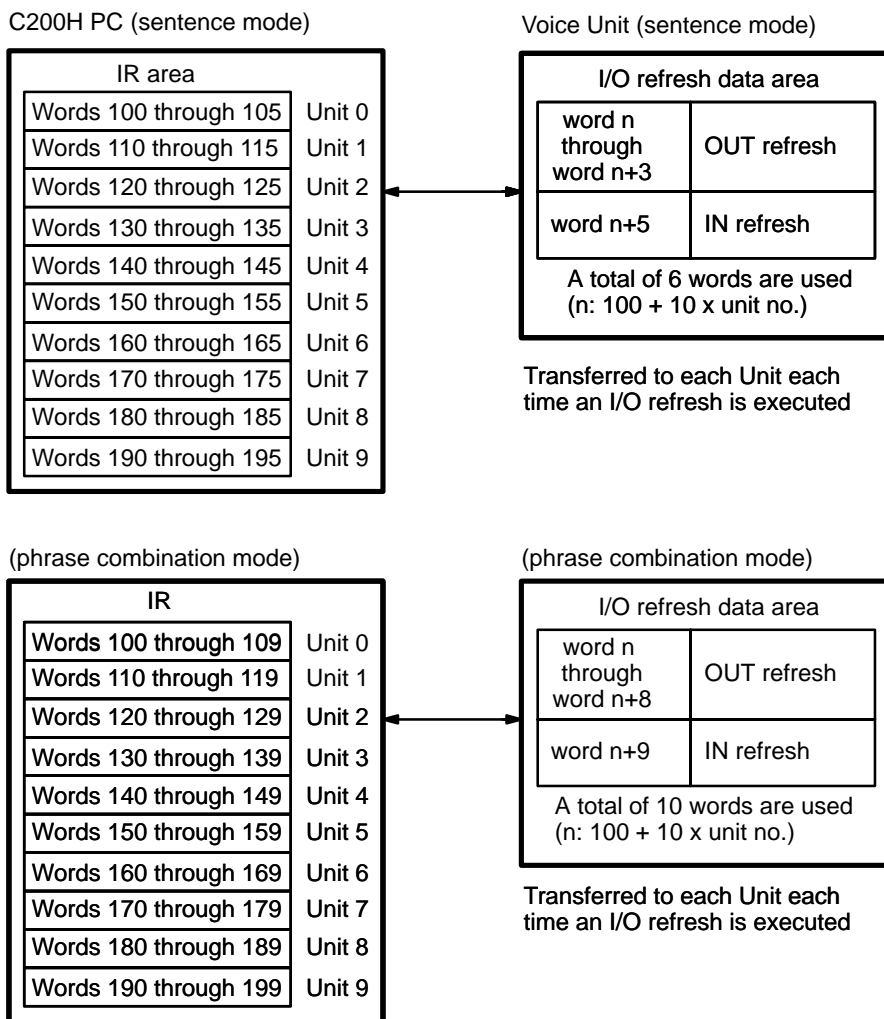

- Note**
1. Do not assign the same unit no. as one of the other Special I/O Units to the Voice Unit; unit no. duplication results in an "I/O UNIT OVER" error.
 2. If the message output mode is changed after creating the I/O table, because the number of allocated words is different, an "I/O SETTING ERROR" will be generated. In this case, re-create the I/O table.

2-2 Bit Number Allocation

IR Bit Allocation

1 Sentence Mode

I/O	Word	Bit number	Bit name	Function																																																																																									
Output	n	03 through 00	Number of repetitions	These bits set the number of times a message is played back in one-shot operation mode. In level operation mode this bit has no function. The repetition value can be set from 0 to 9, or to F. When F is specified, the message is played back repeatedly. When 0 is specified, the message is played back only once. Values A to E if specified, default to 9.																																																																																									
		11 through 04	Repetition interval	These bits set (in BCD) the playback repetition interval. Bits 11 to 08 set the digit to the left of the decimal point (0 to 9 seconds) and bits 07 to 04 sets the digit to the right of the decimal point (0.0 to 0.9 seconds). Note: if a non BCD value is specified the repetition interval defaults to 0.0 second.																																																																																									
		15 through 12	---	Not used																																																																																									
	n+1	00	Stop command	This bit, when ON, inhibits message playback and interrupts message playback. This bit must be OFF for message playback. A message which has been interrupted will not resume playback even if this bit is turned OFF.																																																																																									
<p>Word n+1 bit 01 through word n+4 bit 15 specify the message number to be played back. Each of these bits corresponds to a message number, the correspondence between bits and messages is shown below.</p> <p style="text-align: center;">Bits</p> <table border="1" style="margin-left: auto; margin-right: auto;"> <tr> <td></td> <td>15</td><td>14</td><td>13</td><td>12</td><td>11</td><td>10</td><td>09</td><td>08</td><td>07</td><td>06</td><td>05</td><td>04</td><td>03</td><td>02</td><td>01</td> <td style="text-align: center;">00</td> </tr> <tr> <td>Words</td> <td>n+1</td><td>15</td><td>14</td><td>13</td><td>12</td><td>11</td><td>10</td><td>9</td><td>8</td><td>7</td><td>6</td><td>5</td><td>4</td><td>3</td><td>2</td><td>1</td> <td>Stop command</td> </tr> <tr> <td></td> <td>n+2</td><td>30</td><td>29</td><td>28</td><td>27</td><td>26</td><td>25</td><td>24</td><td>23</td><td>22</td><td>21</td><td>20</td><td>19</td><td>18</td><td>17</td><td>16</td> <td>---</td> </tr> <tr> <td></td> <td>n+3</td><td>45</td><td>44</td><td>43</td><td>42</td><td>41</td><td>40</td><td>39</td><td>38</td><td>37</td><td>36</td><td>35</td><td>34</td><td>33</td><td>32</td><td>31</td> <td>---</td> </tr> <tr> <td></td> <td>n+4</td><td>60</td><td>59</td><td>58</td><td>57</td><td>56</td><td>55</td><td>54</td><td>53</td><td>52</td><td>51</td><td>50</td><td>49</td><td>48</td><td>47</td><td>46</td> <td>---</td> </tr> </table> <p style="text-align: center;">(Numbers 1 through 60 indicate message numbers.)</p>						15	14	13	12	11	10	09	08	07	06	05	04	03	02	01	00	Words	n+1	15	14	13	12	11	10	9	8	7	6	5	4	3	2	1	Stop command		n+2	30	29	28	27	26	25	24	23	22	21	20	19	18	17	16	---		n+3	45	44	43	42	41	40	39	38	37	36	35	34	33	32	31	---		n+4	60	59	58	57	56	55	54	53	52	51	50	49	48	47	46	---
	15	14	13	12	11	10	09	08	07	06	05	04	03	02	01	00																																																																													
Words	n+1	15	14	13	12	11	10	9	8	7	6	5	4	3	2	1	Stop command																																																																												
	n+2	30	29	28	27	26	25	24	23	22	21	20	19	18	17	16	---																																																																												
	n+3	45	44	43	42	41	40	39	38	37	36	35	34	33	32	31	---																																																																												
	n+4	60	59	58	57	56	55	54	53	52	51	50	49	48	47	46	---																																																																												
Input	n+5	00	ON LINE	This bit turns ON when the mode selector switch of the Voice Unit is set to ON-LINE.																																																																																									
		01	---	Not used																																																																																									
		02	Message playback in progress	This bit turns ON during message playback (in ON-LINE mode only). If the message is to be played back repeatedly, this bit remains ON until the message has been played back the specified number of times.																																																																																									
		03	Output memory area FULL	This bit turns ON when the number of messages stored in memory reaches 20 (for ON-LINE and one-shot operation modes only).																																																																																									
		04	Voice Unit error	This bit turns ON if a Voice Unit error occurs or a BCD data error occurs in ON-LINE mode.																																																																																									
		05	Battery error	This bit turns ON when the battery supply voltage is low, or when the battery is not correctly connected.																																																																																									
		06 through 07	---	Not used																																																																																									
		08 through 13	Setting switches	These bits output the setting status of the Voice Unit back panel DIP switches (0 = OFF, 1 = ON). Pins 1 through 6 of the DIP switch correspond respectively to bits 08 through 13.																																																																																									
		14 through 15	---	Not used																																																																																									

n = 100 + 10 x unit no.

2Phrase Combination Mode

I/O	Word	Bit number	Bit name	Function
Output	n	03 through 00	Number of repetitions	These bits set the number of times a message is played back in the one-shot operation mode. In level operation mode this bit has no function. The repetition value can be set from 0 through 9, or to F. When F is specified, the message is played back repeatedly. When 0 is specified, the message is played back only once. Values A to E if specified, default to 9.
		11 through 04	Repetition interval	These bits set (in BCD) the playback repetition interval. Bits 11 through 08 set the digit to the left of the decimal point (0 through 9 seconds) and bits 07 through 04 sets the digit to the right of the decimal point (0.0 through 0.9 seconds). Note: if a non BCD value is specified the repetition interval defaults to 0.0 second.
		12	Priority command	When this bit is turned ON, reproduction of a message under execution is stopped and the newest message, which is transferred at the leading edge of the output command is given priority and reproduced. The interrupted message is reproduced again from the beginning after the priority message has been reproduced.
		13	---	Not used
		14	Output command	A message consisting of specified phrases is played back at the leading edge of this bit (i.e., from OFF to ON).
		15	Stop command	When this bit is turned ON message playback is interrupted. While this bit is ON, messages cannot be played back. When this bit is OFF, the message for which an output command has been issued, or a message stored in memory is played back. A message which has been interrupted will not resume playback even if this bit is turned OFF.
		n+1	15 through 08	1st phrase no.
		07 through 00	2nd phrase no.	
	n+2	15 through 08	3rd phrase no.	
		07 through 00	4th phrase no.	
	n+3	15 through 08	5th phrase no.	
		07 through 00	6th phrase no.	
	n+4	15 through 08	7th phrase no.	
		07 through 00	8th phrase no.	
	n+5	15 through 08	9th phrase no.	
07 through 00		10th phrase no.		

n = 100 + 10 x unit no.

I/O	Word	Bit number	Bit name	Function
Output	n+6	15 through 08	11th phrase no.	
		07 through 00	12th phrase no.	
	n+7	15 through 08	13th phrase no.	
		07 through 00	14th phrase no.	
	n+8	15 through 08	15th phrase no.	
		07 through 00	16th phrase no.	
Input	n+9	00	ON-LINE	This bit turns ON when the Voice Unit mode selector switch is set to ON-LINE.
		01	Voice Unit busy	This bit turns ON when the Voice Unit recognizes the ON status of an output command in ON-LINE mode. It remains ON until the Unit recognizes the OFF status of the command.
		02	Message playback in progress	This bit turns ON during message playback (in ON-LINE mode only). If the message is to be played back repeatedly, this bit remains ON until the message has been played back the specified number of times.
		03	Output memory area FULL	This bit turns ON when the number of messages stored in memory reaches 20 (for ON-LINE and one-shot operation modes only).
		04	Voice Unit error	This bit turns ON if a Voice Unit error occurs or when a BCD data error occurs in ON-LINE mode.
		05	Battery error	This bit turns ON when the battery supply voltage is low, or when the battery is not connected correctly.
		06 through 07	---	Not used
		08 through 13	Setting switch	These bits output the setting status of the Voice Unit back panel DIP switches (0 = OFF, 1 = ON). Pins 1 through 6 of the DIP switch correspond respectively bits 08 through 13.
		14 through 15	---	Not used

n = 100 + 10 x unit no.

The Voice Unit is equipped with an output memory area in which the output commands for several messages are stored. In sentence mode (one-shot operation mode), up to 20 messages can be stored in this area. In phrase combination mode, up to 20 messages can be stored with each message consisting of phrases 1 through 16. (The message being reproduced is not included in the number of messages that can be stored.)

SECTION 3

Operation

3-1	Preliminary Settings	20
3-2	Operating Procedure	21
3-3	REC Mode	22
3-4	PLAY Mode	25
3-5	ERASE Mode	27
3-6	TIME Mode	32
3-7	XMT/RCV Mode	33
3-8	ON-LINE Mode	38
3-9	Operations in ON-LINE Mode	56
3-10	Mixing Function	57

3-1 Preliminary Settings

DIP Switch Setting

Pin 1	OFF	Phrase combination mode
	ON	Sentence mode
Pin 2	OFF	One-shot operation
	ON	Level operation
Pin 3	OFF	Sequential mode
	ON	Priority mode
Pin 4	Be sure to set this switch to the OFF position.	

Pin 5	Pin 6	Recording time
OFF	OFF	64 seconds
ON	OFF	48 seconds
OFF	ON	32 seconds
ON	ON	Not used

As recording time decreases, sound quality increases. During message playback, confirm that the recording time matches the time selected.

Mixing Switch

Set this switch to the ON position to enable the mixing function. Normally, set this switch to the OFF position.

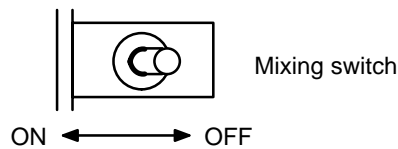

Unit No. Selector

Assign the Voice Unit a unit number with this switch. Do not assign the same unit number as that of another Special I/O Unit to the Voice Unit.

Memory Protect Switch

When using the Voice Unit in the REC, ERASE, or RCV mode set this switch (located in the battery compartment) to the OFF position. In other modes set this switch to the ON position in order to protect recorded messages.

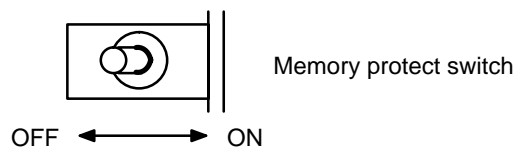

Note When using the Voice Unit for the first time, be sure to clear all the memory areas.

3-2 Operating Procedure

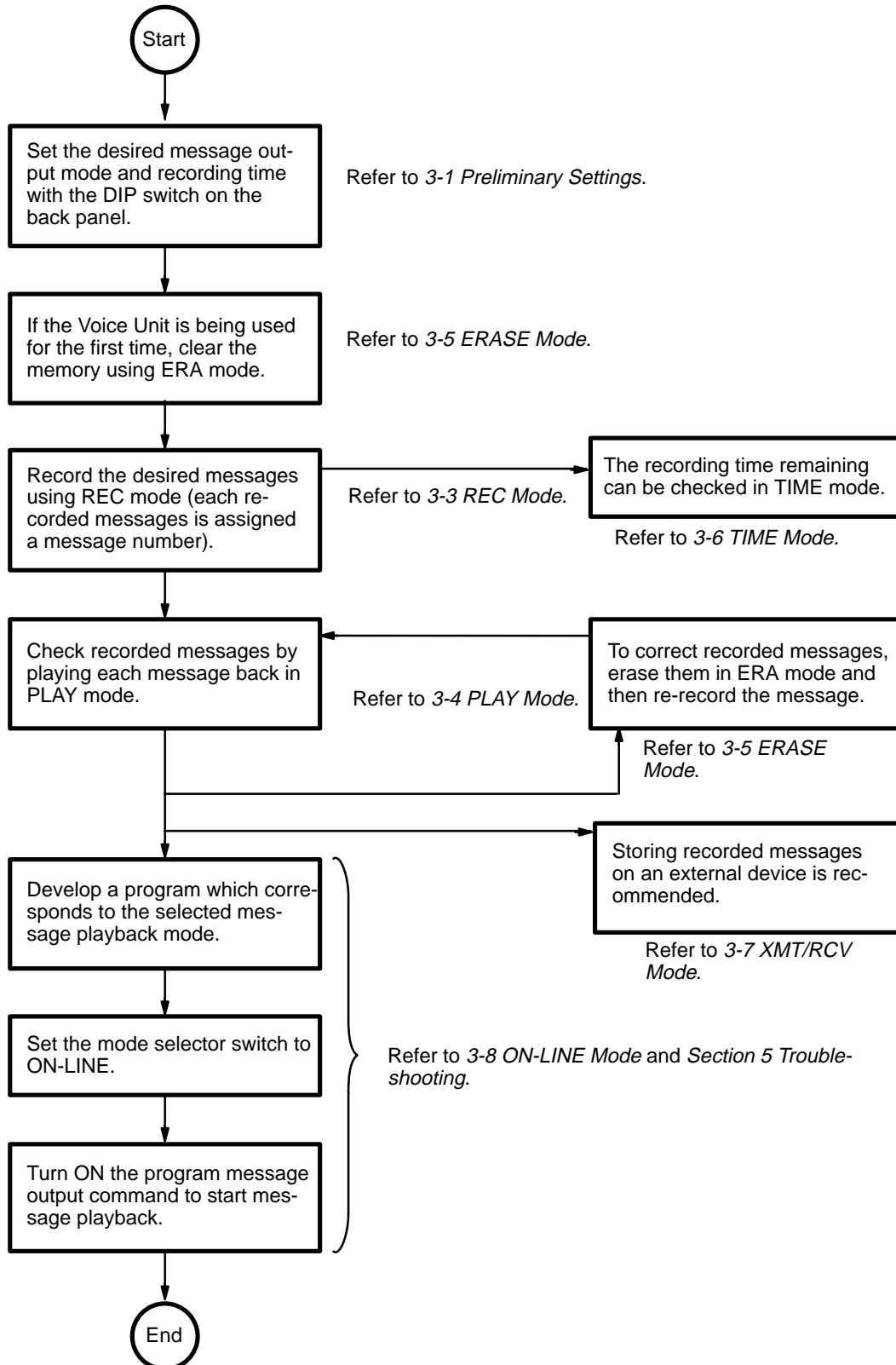

3-3 REC Mode

Recording Procedure

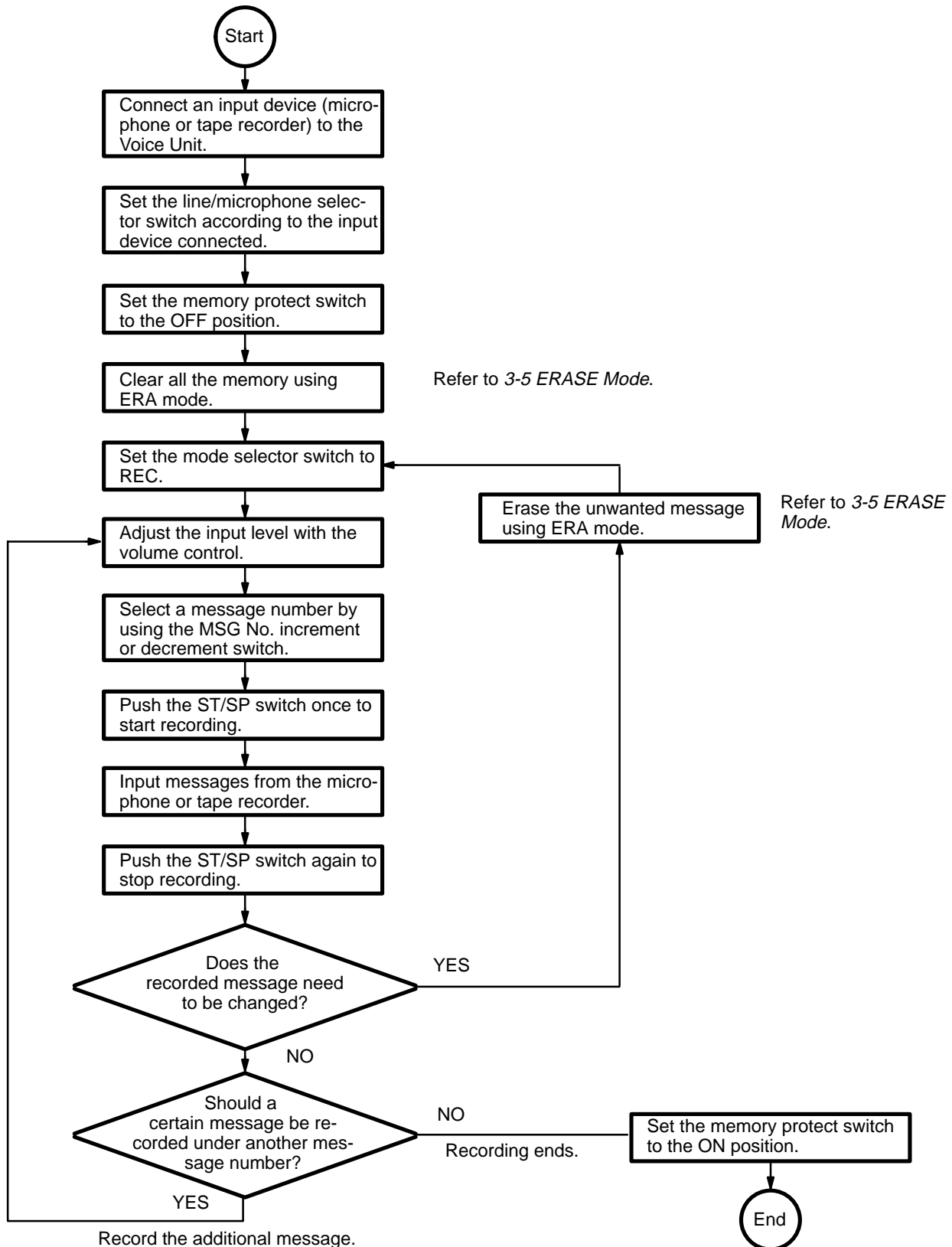

Input Device Connection

A microphone or tape recorder can be connected to the Voice Unit. Using a microphone is simpler, however using a tape recorder improves the sound quality of the recorded message.

When using a tape recorder, recording a signal sound (such as beep) to identify the beginning of the message is recommended.

Connect a microphone or tape recorder to the message input jack of the Voice Unit (for details, refer to *1-3 Input/Output Device Connections*).

Set the line/microphone selector switch according to the input device connected. When a tape recorder is used, set the switch to the L position; set it to the microphone position when using a microphone.

Set the recording time by using pins 5 and 6 of the DIP switch on the back panel of the Voice Unit.

Set the memory protect switch, which is in the battery compartment, to the OFF position.

When the Voice Unit is being used for the first time, be sure to clear the memory.

Set the mode selector to REC

When the Voice Unit is ready for recording, the REC indicator will begin blinking at 0.5 second intervals.

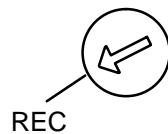

Mode selector switch



The REC indicator is blinking at 0.5 second intervals (indicating recording standby status)

Adjust the input level

When the REC indicator is blinking, the Voice Unit is ready for recording. Input the message to be recorded.

At this time, the input level of the message can be adjusted by using the input volume control. To check the actual message playback volume, connect an external speaker directly or via an amplifier to the message output jack (for speaker and amplifier connection, refer to *1-3 Input/Output Device Connections*).

Adjust the input level of the message as the message is being recorded. When a tape recorder is used, also adjust the output volume of the tape recorder



IN-VOL (input volume control)

Clockwise increases the input volume.

The OVF indicator indicates that an appropriate input level has been selected by blinking intermittently. With an external speaker connected, check the message playback sound quality while adjusting the input level.

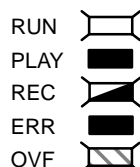

Intermittent blinking of the OVF indicator indicates that an appropriate input level has been selected

Record messages

Assign a message number to each of the recorded messages with the MSG No. increment and decrement switches. The message number allocated by these switches is displayed on the LED MSG No. display. Message numbers from 01 through 60 can be allocated.

In sentence mode, Message no. 01 and Message no. 60 have the highest and lowest priority respectively.

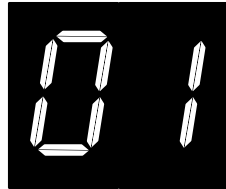

MSG No. indicator (01 through 60)

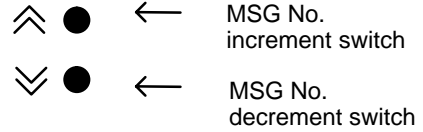

Push the MSG No. increment/decrement switch to increment/decrement the message number.

Prepare the input device (microphone or tape recorder) for recording. (When a tape recorder is used, recording a signal sound such as a beep to indicate the beginning of a message is recommended.)

Push the ST/SP switch. The REC indicator is lit, and recording will begin.

Example

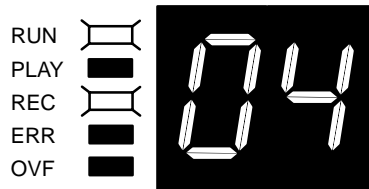

To stop recording, push the ST/SP switch once again.

When recording is finished, the Voice Unit enters standby status.

In this example, message no. 4 is being recorded.

Note Recording is interrupted if the mode is changed during recording. To change a recorded message, erase the message once, and then record the new message. After recording a message, set the memory protect switch to the ON position. It is recommended that the recorded message be copied to peripheral devices for storage. When the ERR indicator lights, refer to 5-1 Error Codes.

3-4 PLAY Mode

Playing Back Messages in PLAY Mode

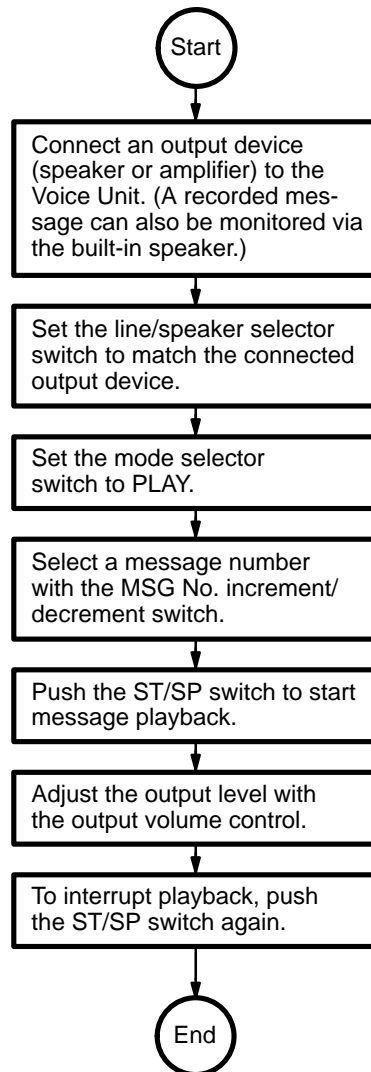

Messages can be played back in PLAY mode and ON-LINE mode. In PLAY mode, messages are played back according to the manual selections the user makes. In ON-LINE mode messages are played back according to the program.

This section describes playback in PLAY mode, which is the simpler of the two modes.

(To playback messages in ON-LINE mode, refer to 3-8 *ON-line mode*.)

Connecting Output Devices

Messages can be checked with the built-in monitor speaker, however to check the volume and sound quality of the messages connect an external speaker or amplifier to the message output jack of the Voice Unit. (For details, refer to 1-3 Interface.)

Set the line/speaker selector switch to match the connected output device. Set the switch to the L position when an external amplifier is connected. Set it to the speaker side when a speaker is connected.

Set the mode selector to PLAY

When the Voice Unit is ready for playback, the PLAY indicator is blinking at 0.5 second intervals.

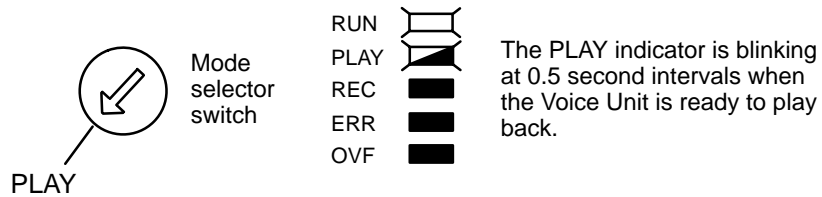

Playing back messages

Specify the message to be played back with the MSG No. indicator display (LEDs) and the MSG No. increment/decrement switch.

Message numbers 00 through 60 can be selected.

When message number 00 is selected, messages 01 through 60 are played back successively. (Message numbers to which no message is assigned are skipped)

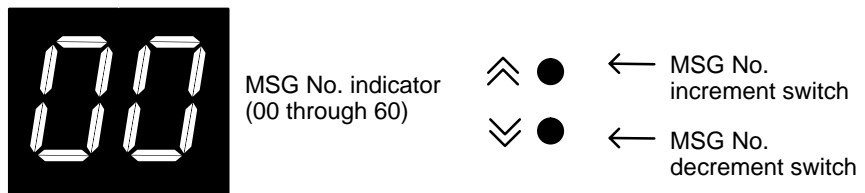

Push the MSG No. increment/decrement switch to increment/decrement the displayed message number.

Push the ST/SP switch to begin playback. The PLAY indicator will light and the message indicated on the MSG No. indicator will be played back.

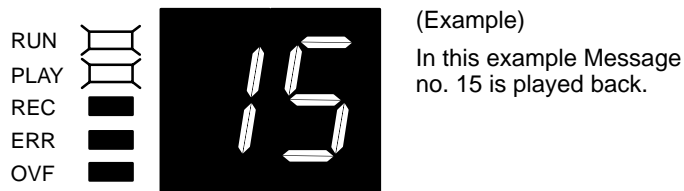

Adjust the output level

Adjust the output volume with the output volume control.

When an external amplifier is used, adjust the volume on the amplifier side (the output volume of the Voice Unit has no effect when the line/speaker selector switch is set to the L position).

To stop playback, push the ST/SP switch.

After playing back a message, the Voice Unit enters standby status.

Note Playback is interrupted if the mode is changed during playback. If the ERR indicator is lit, refer to 5-1 Error Codes.

3-5 ERASE Mode

Messages and displayed error codes can be erased in ERA mode.

Erasing Messages

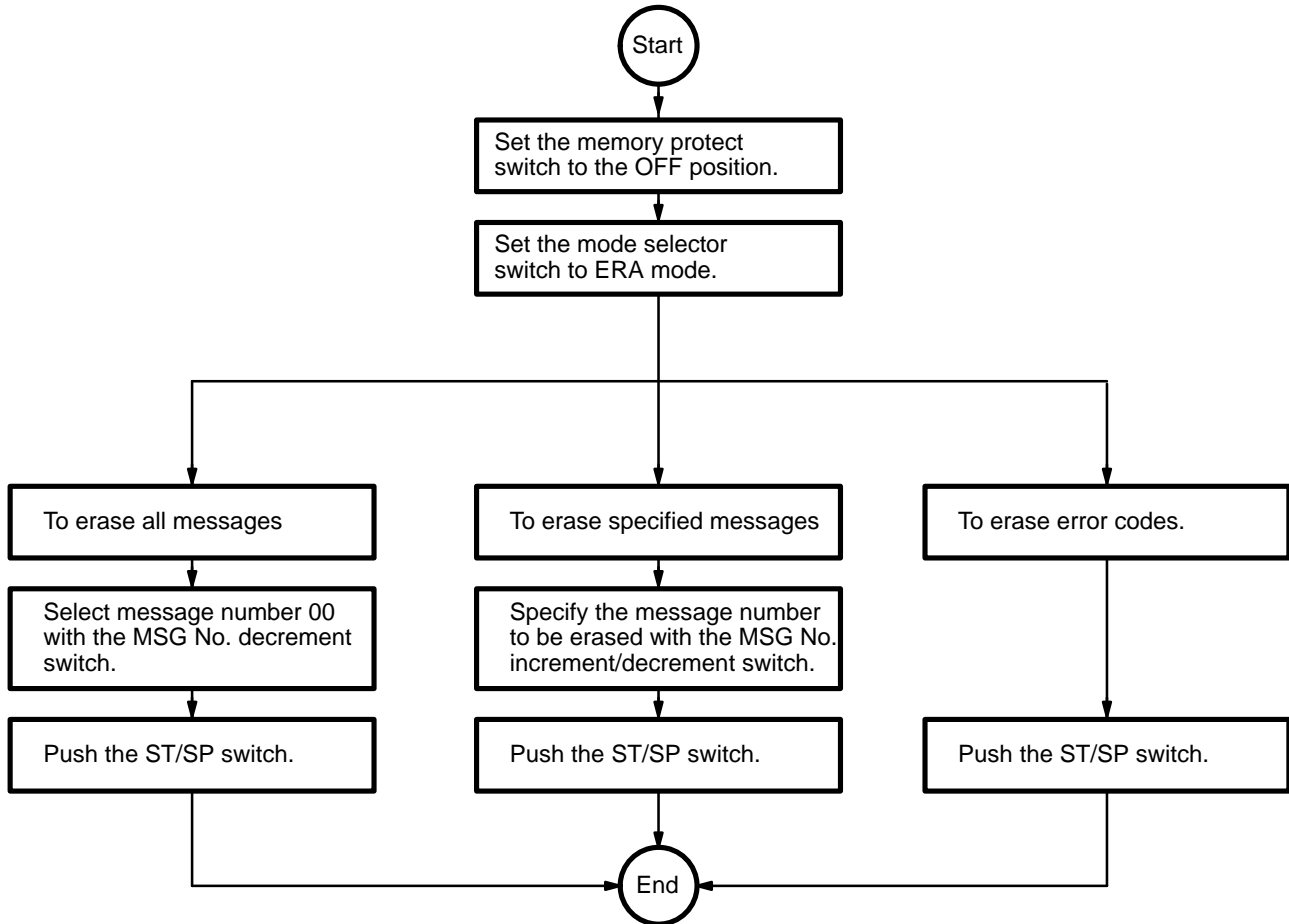

Set the mode selector to ERA

When the Voice Unit is ready, the PLAY and REC indicators are blinking at 0.5 second intervals.



Erase messages

Specify the number of the message to be erased on the MSG No. indicator with the MSG No. increment/decrement switch.

Message numbers 00 through 60 can be specified.

If message number 00 is specified, all messages (01 through 60) are erased.

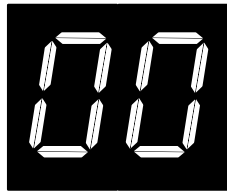

MSG No. indicator
(00 through 60)

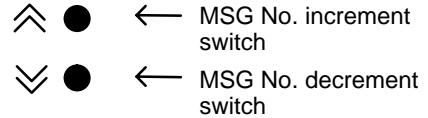

Push the MSG No. increment/decrement switch to increment/decrement the displayed message number.

Push the ST/SP switch. The PLAY and REC indicator will light, and the message indicated by the MSG No. indicator will be erased.

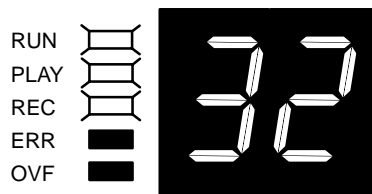

(Example)

In this example Message no. 32 is erased.

Pushing the ST/SP switch during message erasure has no interrupting effect.

After a message has been erased, the Voice Unit enters standby status.

The sum total of the recording time before erasure and the time required for erasure becomes the new recording time.

Note If the ERR indicator is lit, refer to 5-1 Error Codes.

Erasing after a Message Memory Error

If the message memory of the Voice Unit has failed, messages should be erased differently from the method described earlier. Message memory failure is caused by the following two sets of circumstances:

- 1, 2, 3... 1. The data in the memory is replaced with incorrect data (for any reason)
- 2. The power is turned OFF or the PC is reset during message recording or erasure

If the message memory has failed, it is necessary to either erase the contents of the message memory or rewrite its contents.

The contents of the message memory must be erased differently for circumstances (1) and (2) above. (For rewriting the message memory contents in RCV mode, refer to 3-7 XMT/RCV Mode.

Memory failure due to cause 1

In this situation only the RUN and ERR LED indicators are lit, and the Unit is not operative excluding in the ERA and RCV modes.

When ERA mode is selected, "00" is displayed on the MSG No. indicator, and the PLAY and REC indicator are blinking at 0.5 second intervals.

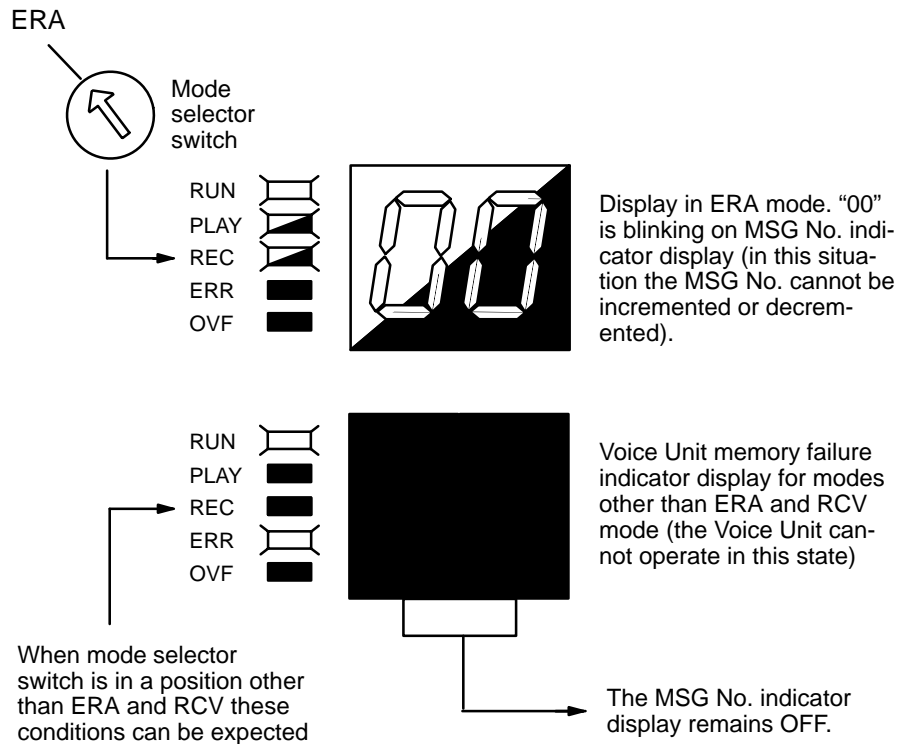

In this state, the only choice that exists is to erase all the messages; to do this push the ST/SP switch.

After pushing the ST/SP switch the PLAY and REC indicators will be lit and all messages in the memory will be erased.



The messages are completely erased even if the ST/SP switch is pushed during the message erasure procedure.

When the messages have all been erased, "00" is displayed on the MSG No. indicator display, and the Voice Unit enters erasure standby status. From this state, other modes can be selected and executed.

Memory Failure due to cause 2

In this situation operation is possible only in ERA or RCV mode. In the remaining modes, RUN and ERR indicators are lit and the Unit is not operative.

When in ERA mode, the message number responsible for the memory failure is displayed on the MSG No. indicator display, and the PLAY and REC indicators are blinking at 0.5 second intervals.

Either one or two messages may cause a memory failure in case (2). If there are two messages causing the failure, their numbers are alternately displayed at 0.5 second intervals on the MSG No. indicator display.

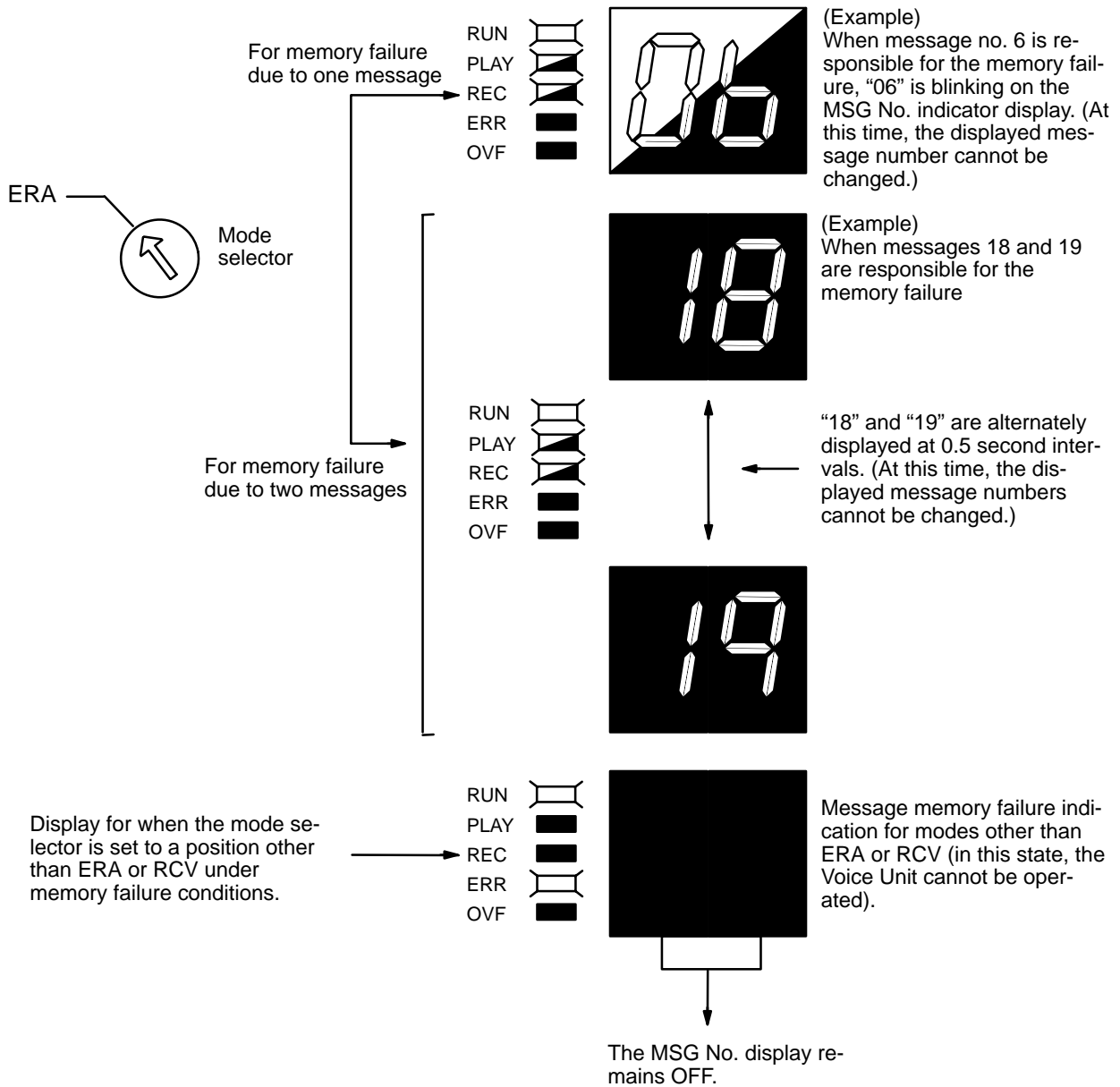

In ERA mode, only the message whose number is displayed on the MSG No. indicator can be erased.

When the ST/SP switch is pushed, the PLAY and REC indicators light, and the one or two messages displayed on the MSG No. indicator are erased.

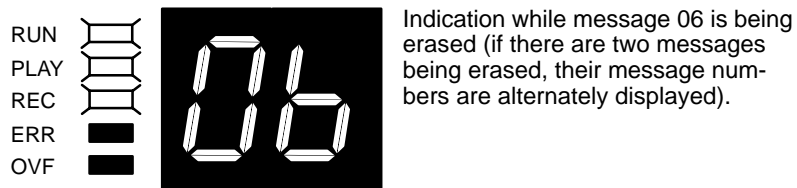

The messages are completely erased even if the ST/SP switch is pushed during the message erasure procedure.

When the messages have all been erased, "00" is displayed on the MSG No. indicator display, and the Voice Unit enters erasure standby status. From this state, other modes can be selected and executed.

Note Do not change modes or turn OFF the power while a message is being erased. Doing so causes a message memory error.

Message Erasing Time

Erasing mode	Maximum erasing time
All messages	2 s
Specified messages	7 s

- Note**
1. The maximum time required to erase a specified message occurs when entire memory is used for messages 1 through 60 (i.e., when the messages are recorded to the full extent of their recording time).
 2. Erasing a specified message takes a longer time than erasing all the messages because the erasure method in each case is different. The differences are as follows:
 - (1) To erase all messages: Only the address table for message numbers is erased.
 - (2) To erase specified messages: The address table of the message numbers and the contents of the message memory are rewritten.

Note The “address table” is a table that records the size of a message and the memory address location of the message.

3-6 TIME Mode

Displaying the Remaining Recording Time

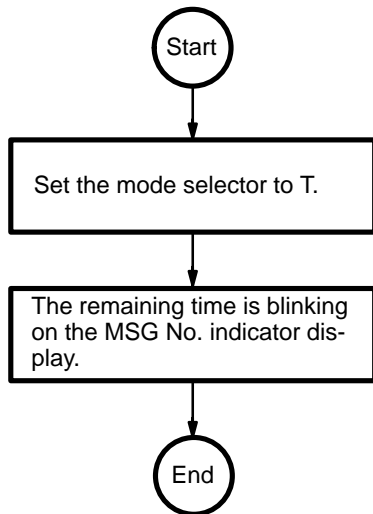

Checking the Remaining Time

Set the mode selector to T (remaining time display mode).

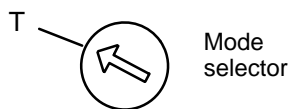

The remaining recording time is displayed on the MSG no. indicator.

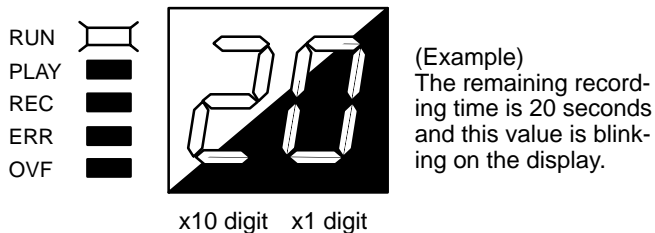

Note If the ERR indicator is lit, refer to 5-1 Error Codes.

3-7 XMT/RCV Mode

Transmitting/Receiving Data to/from an External Device

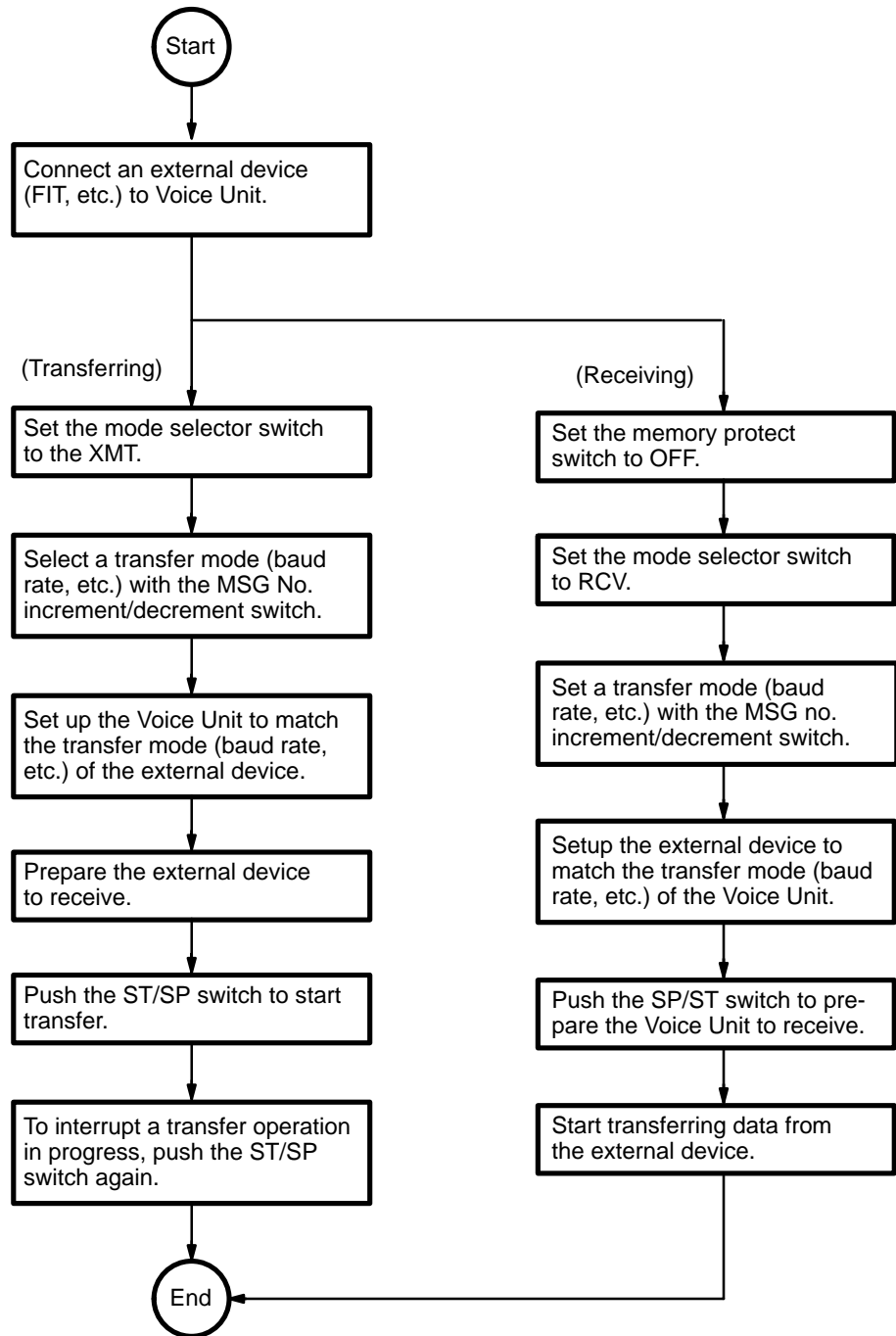

Data (messages) in the Voice Unit memory is transferred to external devices via the RS-232C port of the Unit. External storage devices include computers, PROM chips (via a PROM Writer), etc.

Connecting External Devices

For details on how to connect an external device to the Voice Unit, refer to *1-3 Input/Output Device Connections*.

When connecting to a computer, communication software must be developed by the user.

For connections to other external devices refer to the specifications of the external device.

Voice Unit Communication Mode Particulars

Transfer format: Intel HEX

Baud rate: 2,400/4,800/9,600/19,200 bps (selectable)

Control mode: RTS/CTS control, XON/XOFF control (valid/invalid)

Bit format: 7 data bits, 2 stop bits, even parity

RTS/CTS Signal Details

Transfer (Voice Unit side)

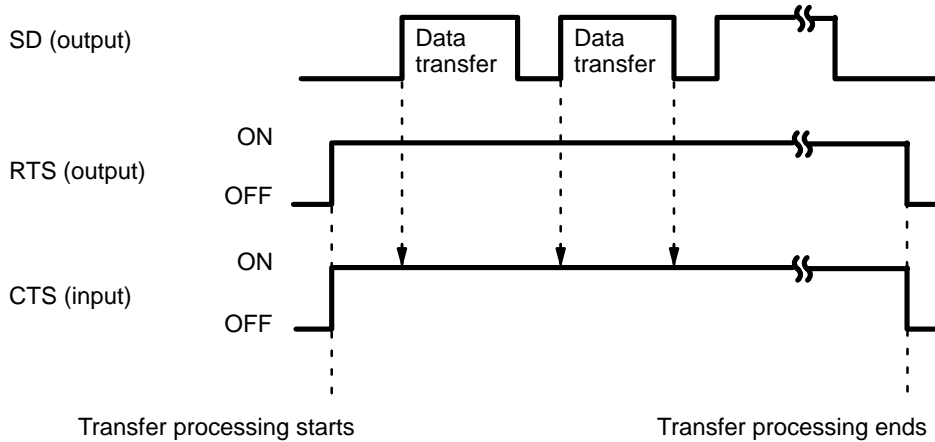

Receiving (Voice Unit side)

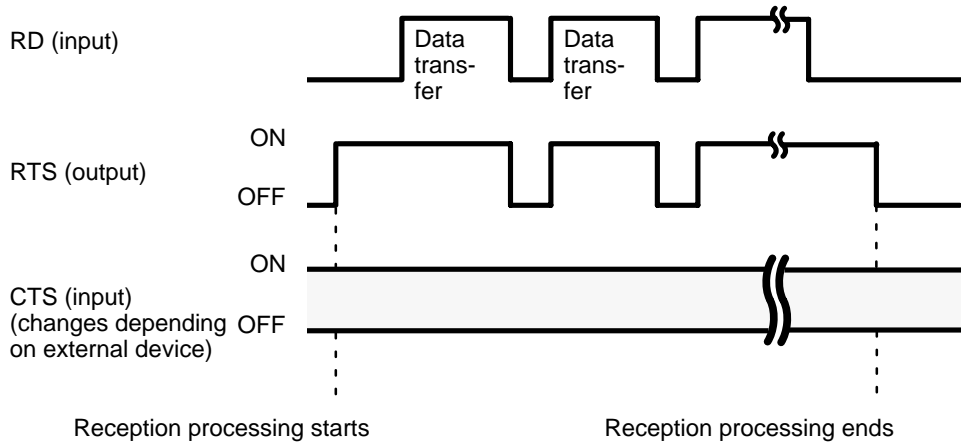

Transmitting

Push the ST/SP switch to turn ON the RTS signal, and starts transmitting data after confirming that RTS has turned ON.

The CTS signal turns ON each time data has been transferred. The RTS turns OFF either when transfer processing has been completed normally or when the ST/SP switch is pushed again.

Receiving

Push the ST/SP switch to turn ON the RTS signal. The RTS signal turns OFF each time data has been received and stored in the memory of the Voice Unit.

The RTS signal turns OFF either when reception processing has been completed or when the ST/SP switch is pushed again.

Note Data transfer from the external device is enabled when the RTS signal of the Voice Unit is ON.

The RTS/CTS signals are ignored when the RTS/CTS signals are set as invalid.

XON/XOFF Communication Data

- (1) The Voice Unit temporarily stops transmission when it receives a "\$13" data value (XOFF code) during data transmission between itself and an external device. When the Voice Unit receives a "\$11" data value (XON code), it resumes data transmission.
- (2) The Voice Unit transfers a "\$13" data value (XOFF code), during data reception, when its receive buffer is filled to 3/4 of its capacity. The Unit sends out an "\$11" data value (XON code) when its receive buffer is at 1/4 of its capacity.

Baud Rate, RTS/CTS, XON/XOFF, and Transfer Range

- (1) Set the mode selector to the XMT or RCV position.

XMT mode

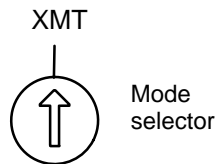

The following will be indicated:

RUN			The display to the left indicates XMT (transmission) standby status. The MSG no. indicator displays a communication mode value (refer to the table below). The PLAY indicator is blinking at 0.2 second intervals.
PLAY			
REC			
ERR			
OVF			

RCV mode

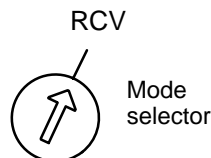

RUN			The display to the left indicates RCV (reception) standby status. The MSG No. indicator displays a communication mode (refer to the table below). The REC indicator is blinking at 0.2 second intervals.
PLAY			
REC			
ERR			
OVF			

- (2) Select communication modes (displayed on the MSG no. indicator display) with the MSG no. increment/decrement switch.

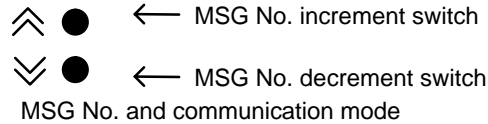

(x10 digit)

No.	Baud rate (bps)	XON/XOFF (yes/no)
0	2400	no
1	4800	
2	9600	
3	19200	
4	2400	yes
5	4800	
6	9600	
7	19200	

(x1 digit)

No.	Transfer range (bits)	RTS/CTS (yes/no)
0	All data (1M byte)	no
1	First half (512K bytes)	
2	Second half (512K bytes)	
3	All data (1M byte)	yes
4	First half (512K bytes)	
5	Second half (512K bytes)	

Example

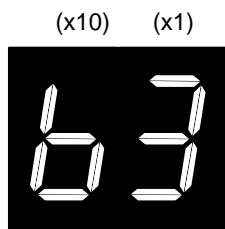

When communication mode shown on the Message no. indicator display is set to "63"

- Baud rate : 9,600 bps
- XON/XOFF control : valid
- Range : all data (1M bit) of message memory
- RTS/CTS control : valid

For the set number, refer to the table on the previous page.

Transfer Method

Confirm that the transmit standby status is set, that the necessary communication mode is set, and that the external device is ready for reception. Then push the ST/SP switch.

During data transfer the PLAY indicator blinks at high speed (in synchronization with data transmission.)

RUN			(Example) Display indication while data transfer is being executed in communication mode "63"
PLAY			
REC			
ERR			
OVF			

The data transfer is interrupted when the ST/SP switch is pushed.
When transfer has finished, the Voice Unit enters transfer standby status.

Data Receiving Method

Select the communication mode required while in reception standby status and then push the ST/SP switch, which starts the transfer of data from an external device.

During data transfer to the Voice Unit the REC indicator on the Voice Unit is blinking at high speed (in synchronization with data transfer).

RUN			(Example) Display indication in communication mode "63" after the ST/SP switch has been pushed
PLAY			
REC			
ERR			
OVF			



RUN		Display indication while data is being received
PLAY		
REC		
ERR		
OVF		

When the ST/SP switch is pushed while reception is in progress, reception stops and an error occurs in the message memory. In this case, either begin the reception process from the start, or erase all the messages.

After reception has been completed, the Voice Unit enters reception standby status.

Note When data is divided into a first half and second half (512K bits each) and is transferred to the Voice Unit, the Unit will not operate properly if it has only received the second half of the data. Also, the Unit may issue incomprehensible sounds when it has received only the first half of the data, or data of more than 512K bits.

Even if the mode selector is changed during communication, the currently set mode is not changed until communication ends.

If the ERR indicator is lit, refer to 5-1 Error Codes.

Receiving Data After a Message Memory Error

If an error occurs in the Voice Unit's message memory, the error can be cleared by writing new messages from an external device to the memory of the Unit. (The contents of the message memory can also be erased to clear the error.)

Message memory failure is indicated by the following:

Only the RUN and ERR indicators are lit and nothing can be executed in a mode other than RCV (reception) and ERA (erase).

When RCV mode is selected, the REC indicator is blinking at 0.2 second intervals.

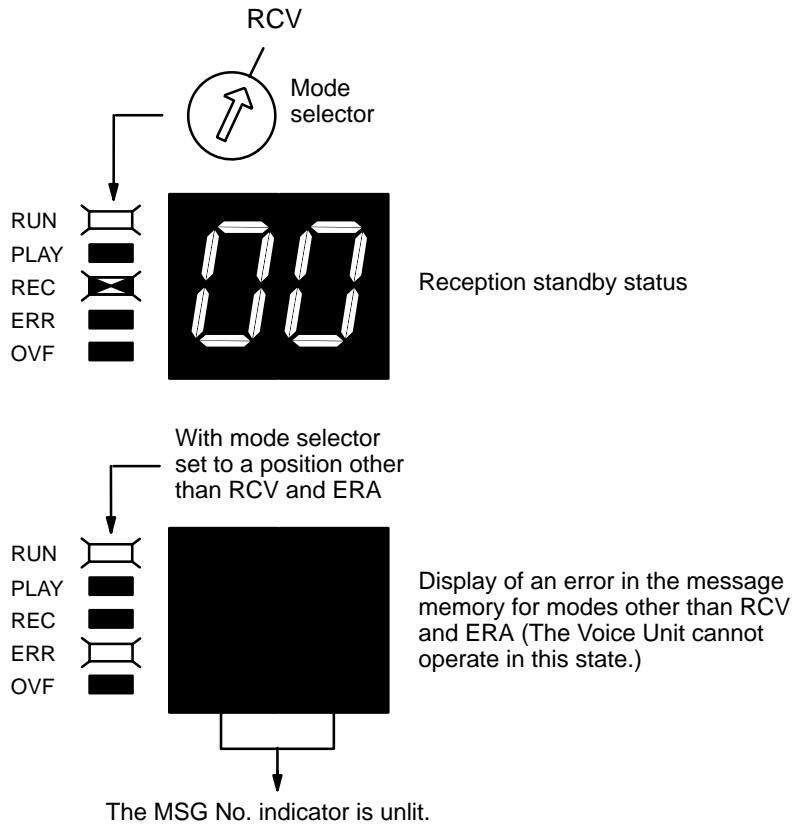

Message Data Transfer/Reception Time

Baud rate (bps)	Transfer time (max.)
19200	11 minutes
9600	13 minutes
4800	20 minutes
2400	30 minutes

- RTS/CTS control (valid)
- XON/XOFF control (valid)
- Range: all data (1M bit)
- When the entire message memory is used.

3-8 ON-LINE Mode

Set the mode selector to ON-LINE; at this time only the RUN indicator should be ON. In ON-LINE mode, the Voice Unit is controlled by the PC program.

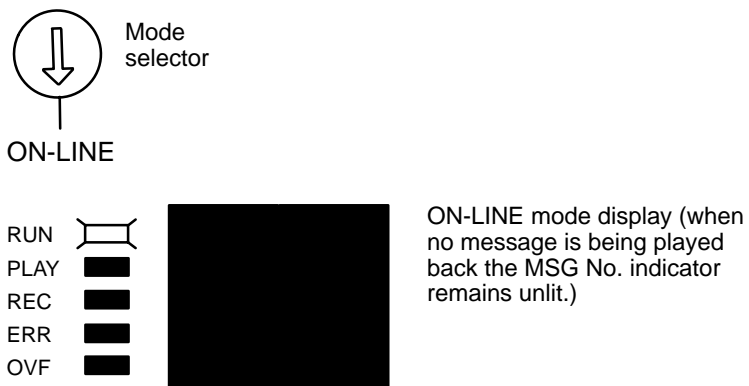

In ON-LINE mode, any message or any combination of phrases stored in the memory can be selected and played back by the program.

Display Indication during Message Playback

Displays for sentence mode

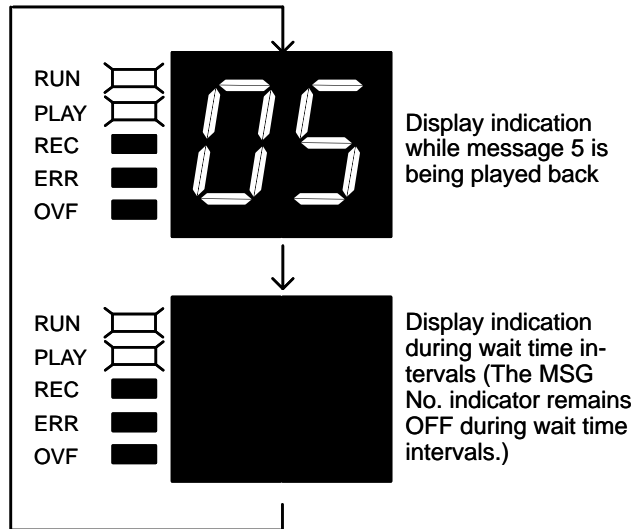

Displays for phrase combination mode

The example below shows the display indications when phrase no. 2 and 10 are combined.

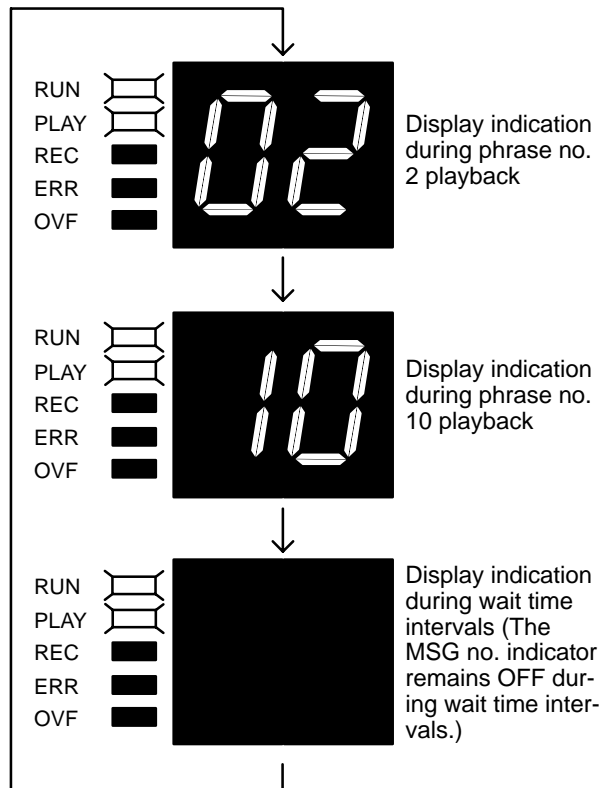

Note "Wait time" is the time in between message playback repetitions. If the ERR indicator is lit, refer to 5-1 Error Codes.

Sentence Mode Timing Diagrams

Basic One-Shot Operation

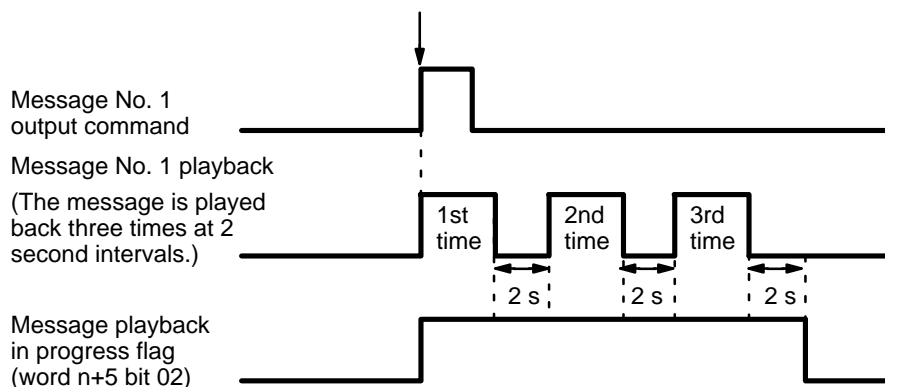

The number of times a message is played back and the intervals at which message playback is repeated are recognized at the leading edge of the Message No. 1 output command.

One-Shot Operation in Sequential Mode

In the following example, it is assumed that the data for each message is set at the leading edge of the output command of each message:

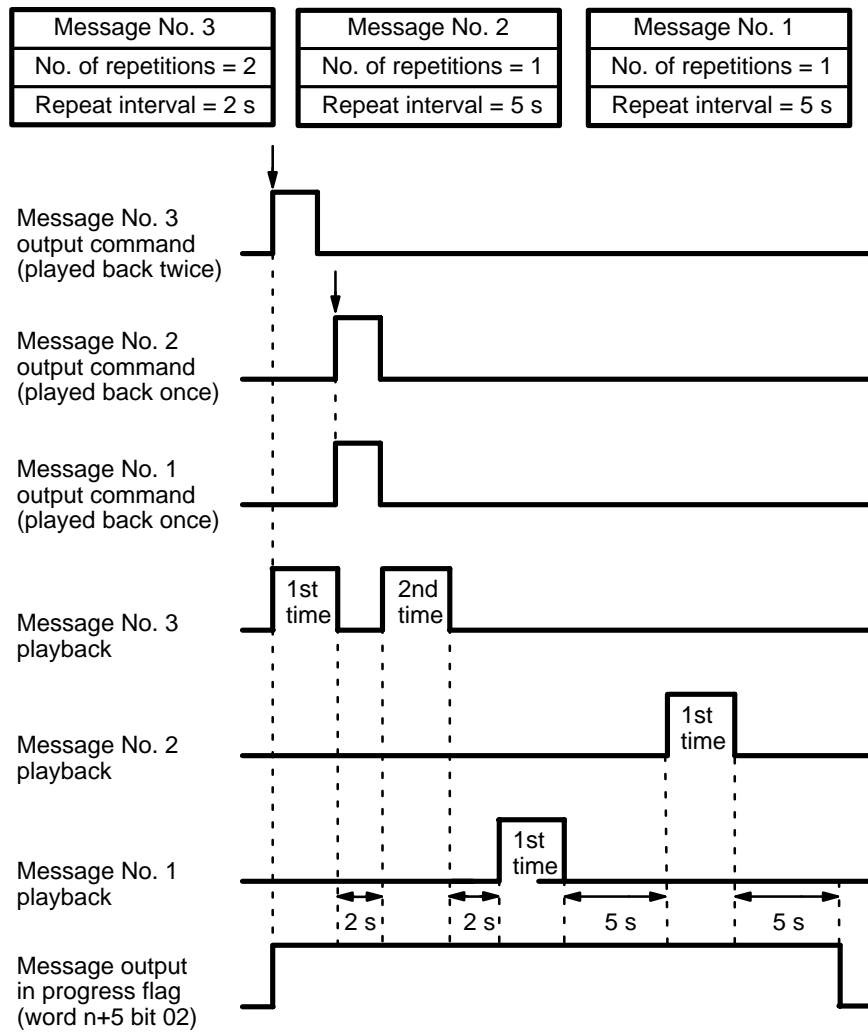

The messages are played back in the order of which respective output command is turned ON first, second, third, etc

If the output commands of two or more messages turn ON at the same time, the message having the lower message number takes precedence. In this case, the messages are still played back the same number of times and at the same intervals that have been set for them.

The time interval between message playback (for two or more different messages) is the same as the time interval of the previously played back message. In the above example, 2 seconds elapse between the end of Message No. 3 and the start of Message No. 1, and 5 seconds elapse between the end of Message No. 1 and the start of Message No. 2.

One-Shot Operation in Priority Mode

In the following example, it is assumed that the data for each message is set at the leading edge of the output command of each message:

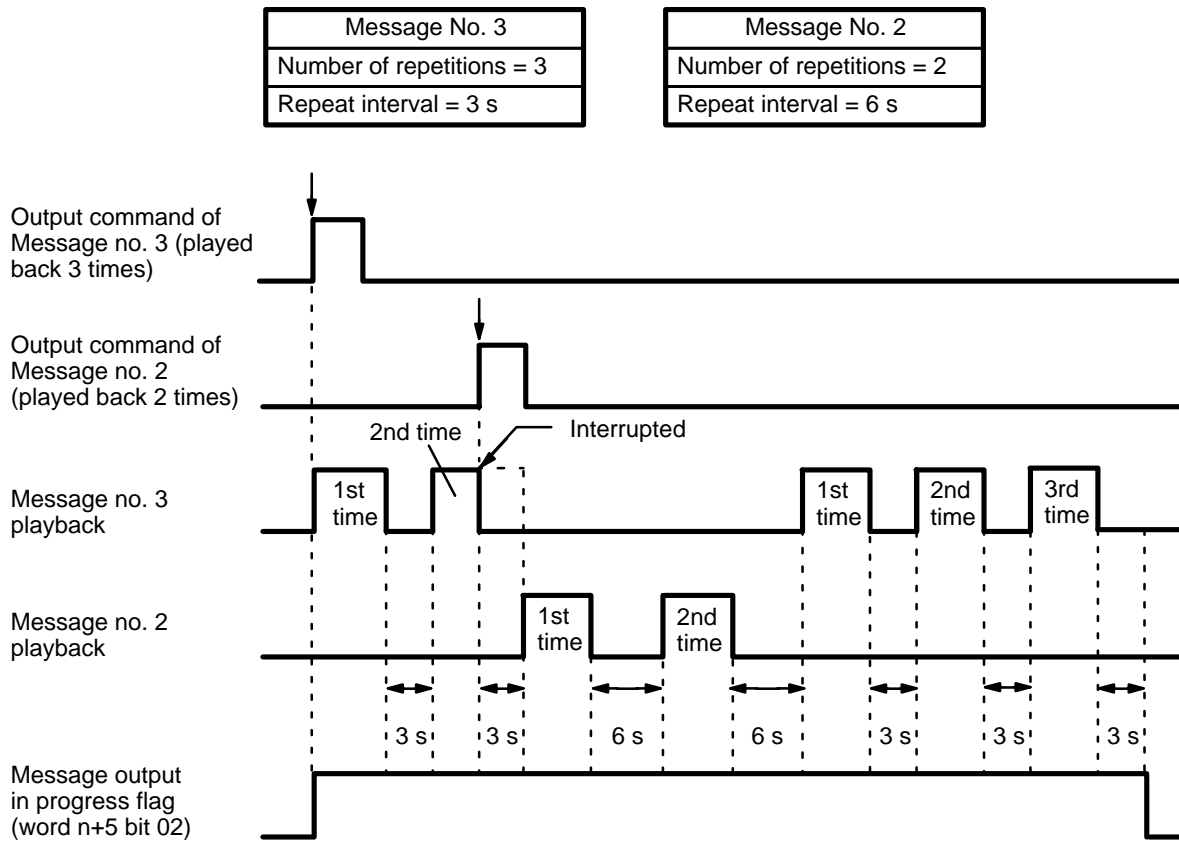

The messages are played back in the order of the lowest to the highest message number. The message with the lowest message number, when its output command turns ON, takes precedence over the message currently being played back and consequently interrupts its playback. The interrupted message is played back from the beginning again after the message with the lower message number has been played back.

The repeat intervals are the same as in (1).

When message playback is interrupted, the playback time of the interrupted message must pass before the next message will be played back.

Basic Level Operation

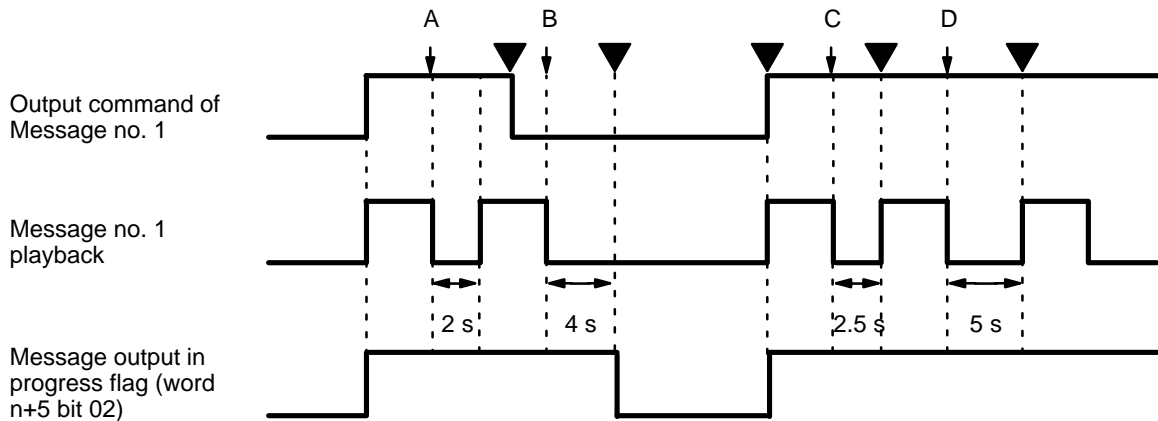

The message whose output command turns ON is played back at the leading edge of the output command. If the output command turns ON when the

message has been played back and the specified interval time has elapsed (point indicated in the figure), that message is repeatedly played back.

The repeat interval is recognized when playback of a message has been completed (points A through D in the figure). The repeat interval specified at that time (2, 4, 2.5, or 5 seconds) first elapses before the next message is played back.

Level Operation in Sequential Mode

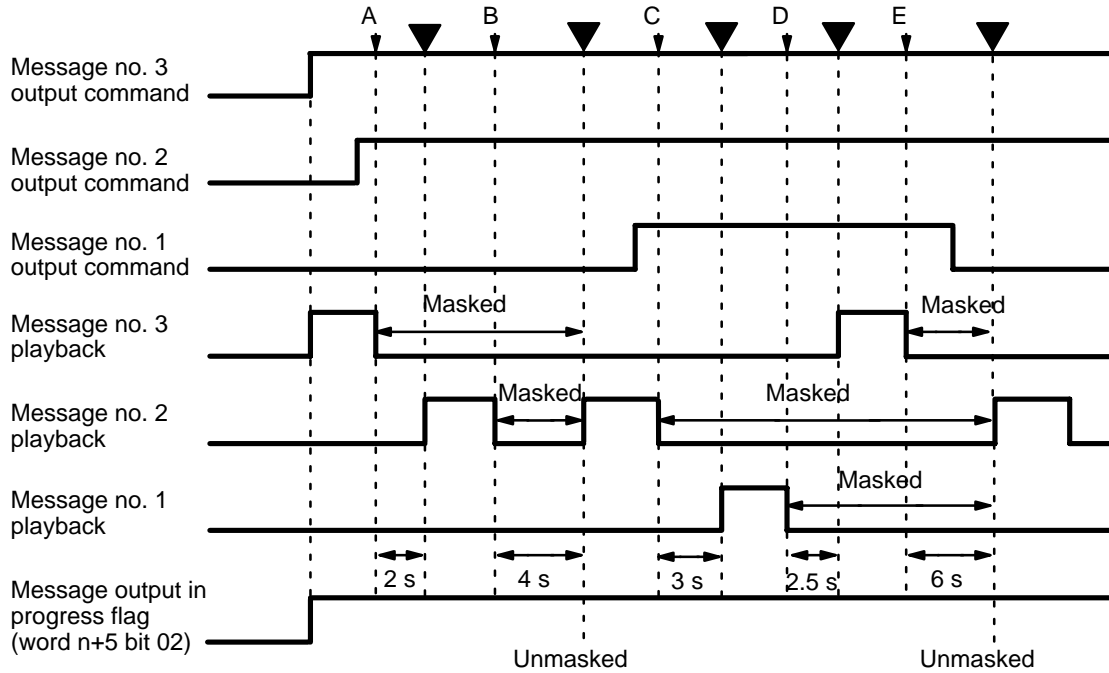

The message playback interval is recognized at each of points A through E (where playback ends). The specified interval time elapses first before the next message is played back.

The output command of a message is recognized at its leading edge and when playback of the message has ended and the specified interval time has elapsed (point indicated in the figure).

If more than one output command turns ON at the point indicated in the figure, then messages are played back according to the following rules:

1. When a message has been played back once, the output command of that message is masked.
2. Of the messages whose output commands have turned ON and have not yet been masked, the message having the lowest number is played back.
3. After all messages whose output commands have turned ON have been played back (at this time, all the output bits of messages whose output command is ON are masked), all the output commands are unmasked, and the message having the lowest message number is played back.

Note Masking means to temporarily stop playback of a message so that another message can be played back even while the output command of the masked message is turned ON.

Level Operation in Priority Mode

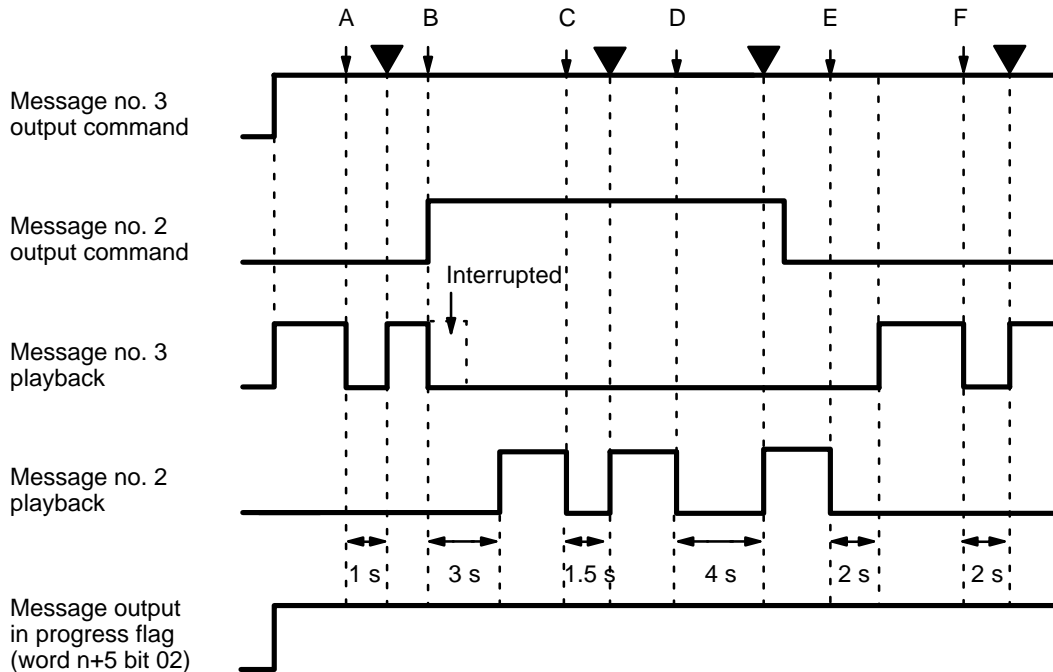

Of the messages whose output command have turned ON when one message has been played back and its interval time has elapsed, the message having the lowest message number is played back. However, if the output command of a message having a message number lower than that of the message currently played back turns ON, playback of the current message is interrupted, and the message having the lower message number takes precedence.

The message interval is recognized at points A through F in the figure (at which the playback of each message ends), and the next message is played back after the specified interval time has elapsed.

The same applies when playback of the current message is interrupted by a message having a higher priority (point B in the figure).

Stop Command (word n+1 bit 00)

When the stop command turns ON, playback of the current message is stopped. Messages are not played back while the stop command is ON.

Recorded messages continue to play back when the stop command has turned OFF.

However, the message interrupted by the stop command is not played back even after the stop command has turned OFF. This message is only played back when its output command turns ON again.

(Example) One-shot operation in sequential mode

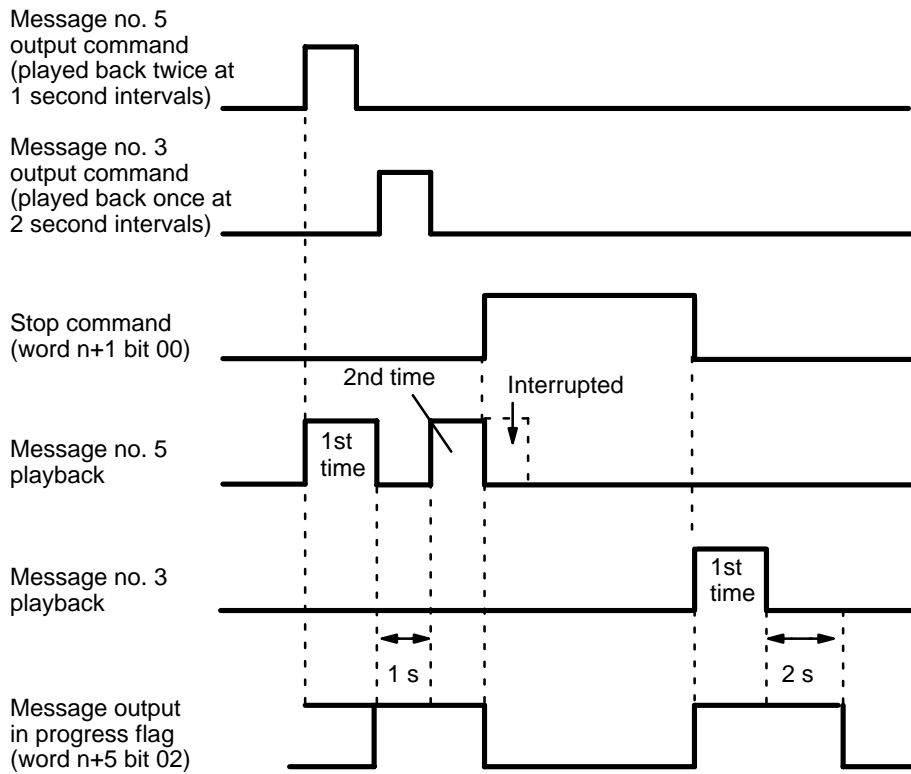

PC Data Transfer Program Data Transfer

When the Voice Unit is operated in ON-LINE mode, the following type of program must be written for the PC:

Example

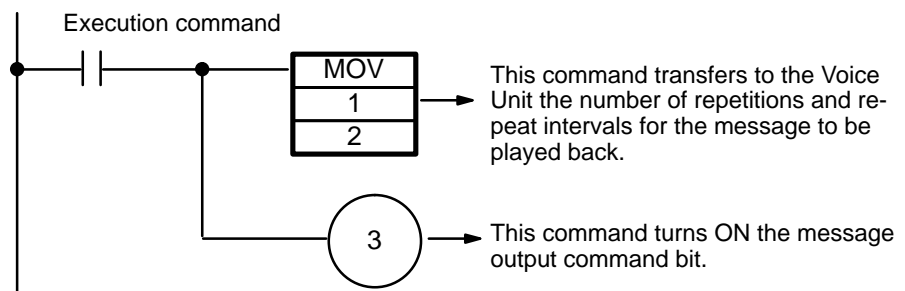

1. Number of repetitions and repeat intervals
2. Word n ($n = 100 + 10 \times \text{unit no.}$)
3. Message output command bit

Data and I/O Refresh Timing

Data is transferred between the Voice Unit and PC when PC I/O data is refreshed.

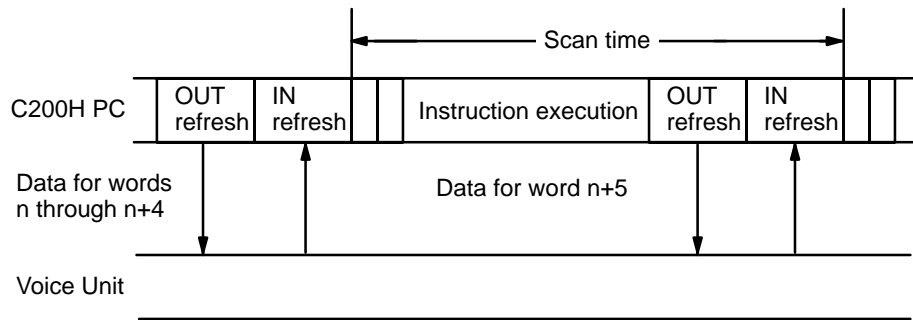

OUT refresh (PC → Voice Unit)

- Number of playback repetitions
- Repeat interval
- Message output command
- Stop command

IN refresh (Voice Unit → PC)

- ON-LINE flag
- Message output in progress flag
- Output message area FULL flag
- Voice Unit error flag
- Battery error flag
- DIP switch setting status flags

Note The scan time increases to 3.5 ms when the Voice Unit is used in sentence mode.

Flags and I/O Refresh Timing

- **ON-LINE flag (word n+5 bit 00)**
 The ON-LINE flag turns ON when input refreshing is executed after the mode selector switch of the Voice Unit has been set to ON-LINE.

 The ON-LINE flag turns OFF the next time input refreshing is executed after a switch from ON-LINE to any other mode has been made.
- **Message output in progress flag (word n+5 bit 02) (valid in ON-LINE mode only)**

 This flag turns ON when input refreshing is executed during message playback. This flag turns OFF when the next input refreshing is executed, provided the message has been played back and the specified repeat interval time has elapsed.
- **Output storage area and FULL flag (word n+5 bit 03) (valid in ON-LINE mode only)**

 During one-shot operation a maximum of 20 messages excluding the message in current playback can be stored in the output message area.

 In sequential mode when all 20 messages are stored in this area, new ON output commands are not accepted.

 In priority mode, only the message having the lowest message number is accepted while the message having the highest number is canceled.

 The contents of the message area are sequentially incremented each time a message has been played back.

One-shot operation in sequential mode

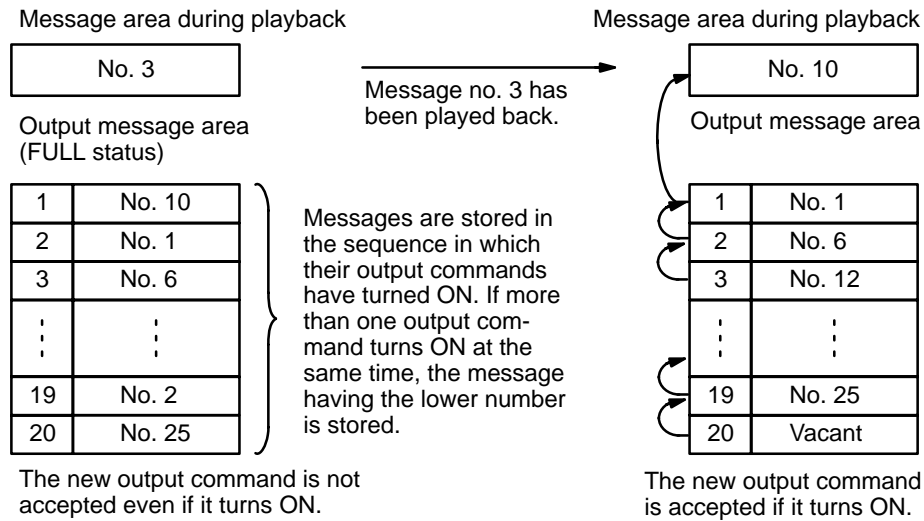

One-shot operation in priority mode

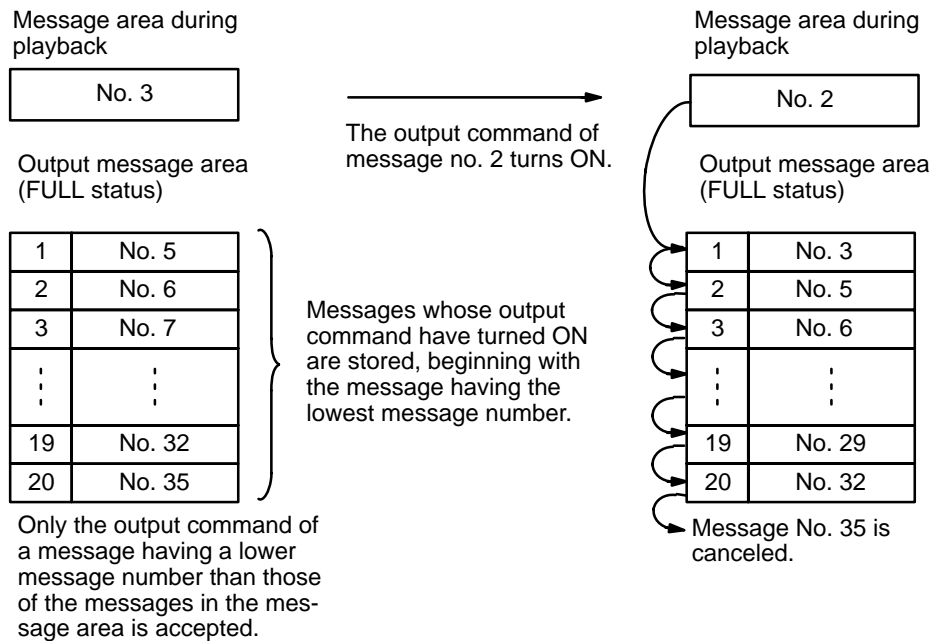

The output message area FULL flag turns ON in response to the output command during OUT refreshing when the number of messages stored in the storage area reaches 20, and when the input data in the same I/O refresh area is refreshed. During the next input refreshing, when the number of messages decreases to 19 or less, the flag turns OFF.

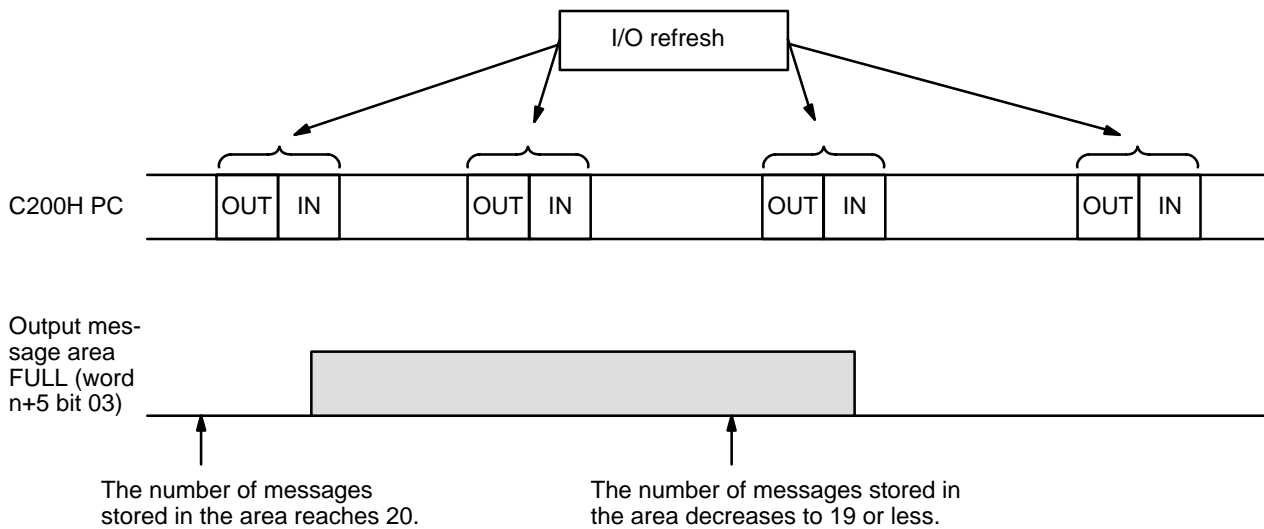

- Message output in progress flag (word n+5 bit 04)

In modes other than ON-LINE mode

This flag operates in the same manner as the ERR indicator on the Voice Unit.

For information on the ERR indicator, refer to 5-1 Error Codes.

In ON-LINE mode

The message output in progress flag turns ON when the ERR indicator on the Voice Unit is lit (i.e., when a memory error occurs or when no message is recorded), and operates as follows:

The flag turns ON when: input refreshing occurs in the same I/O refresh area where the previous output refresh was executed; if the number of repeat intervals is specified using non-BCD data (excluding "F"); or if the output command of a message which is not recorded turns ON.

The flag turns OFF after the correct data is received when output refreshing and input refreshing occur in the same I/O refresh area.

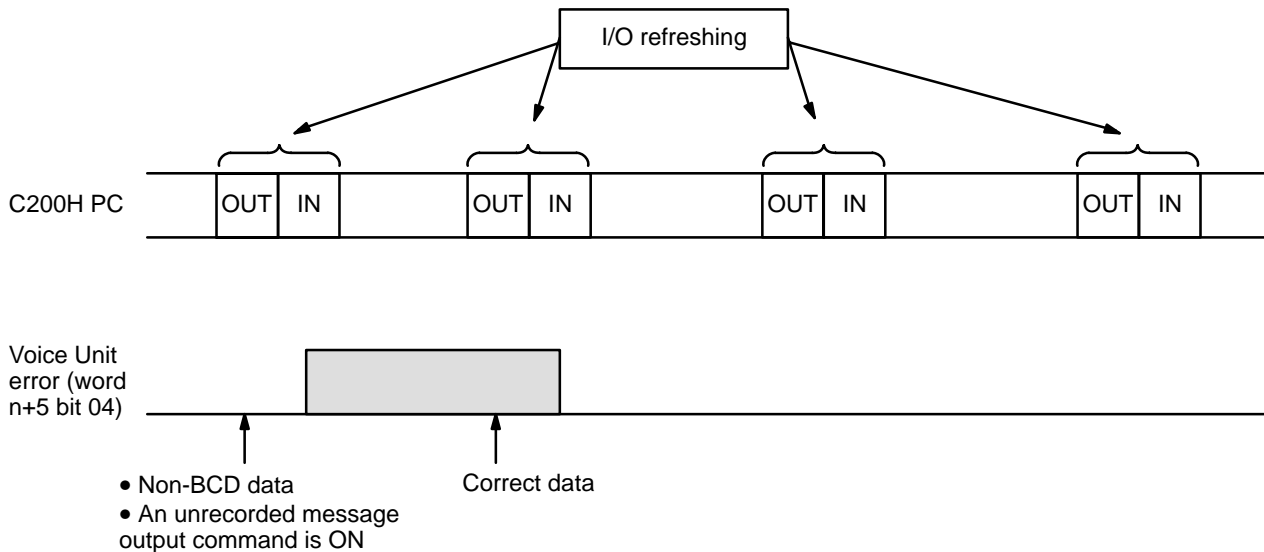

- Battery error flag (word n+5 bit 05) (valid in all modes)

This flag turns ON, during input refreshing, when the supply voltage of the battery drops or the battery is not correctly connected. It turns OFF, during

input refreshing, if the battery has been connected correctly or if a new battery has been connected.

In Phrase Combination Mode

Basic Message Playback Timing

In the following example, phrase no. 5, 18, and 36 are combined. These phrases are played back in this order twice at 5 second intervals.

Basic Example

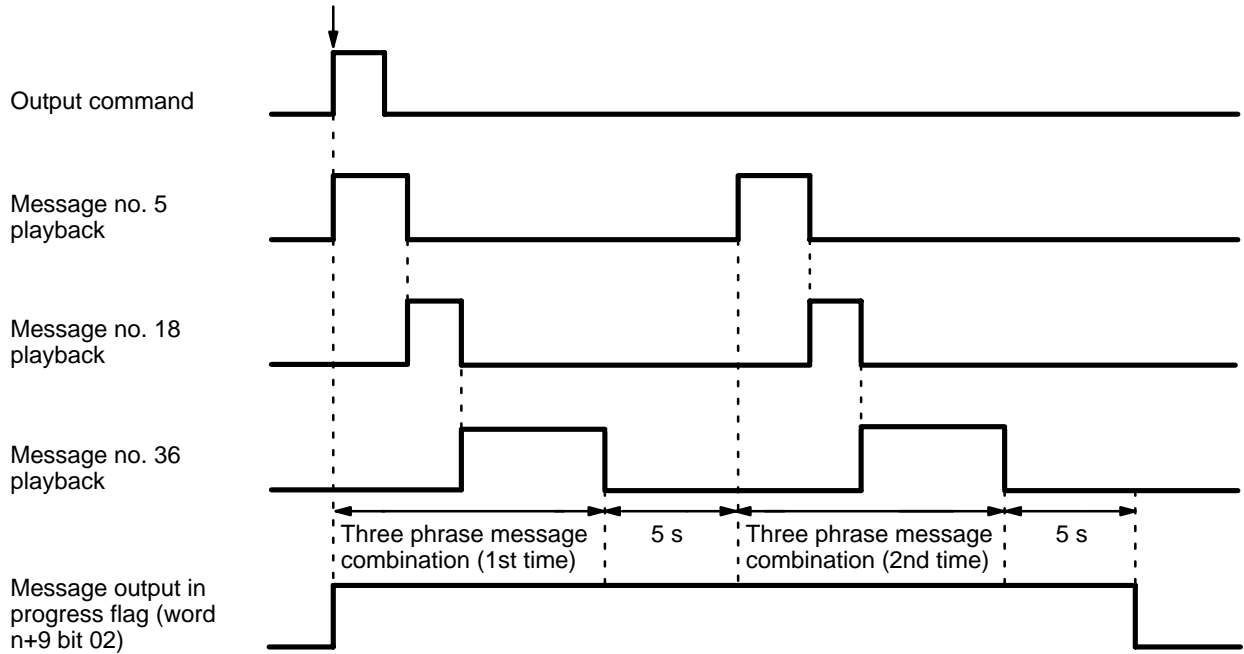

The number of repetitions and the repeat sequence for the above message playback are recognized at the leading edge of the output command (point indicated in the figure).

Phrase nos. 5, 18, and 36 are played back in this order at 0 second intervals and together make up one message. The message is played back the second time 5 seconds later.

The message output in progress flag turns ON at the leading edge of the output command, and OFF after the message has been played back the second time and the specified interval time has elapsed.

In the following example, it is assumed that phrases are combined, to form messages, as shown in the table below.

When More Than One Output Command Turns ON

	Phrase Combination	Number of repetitions	Repeat intervals	Priority command
Message no. 1	Phrase nos. 1, 5, and 2	2 times	2 s	OFF
Message no. 2	Phrase nos. 3, 6, 4, and 2	3 times	3 s	OFF
Message no. 3	Phrase nos. 1 and 10	1 time	4 s	ON

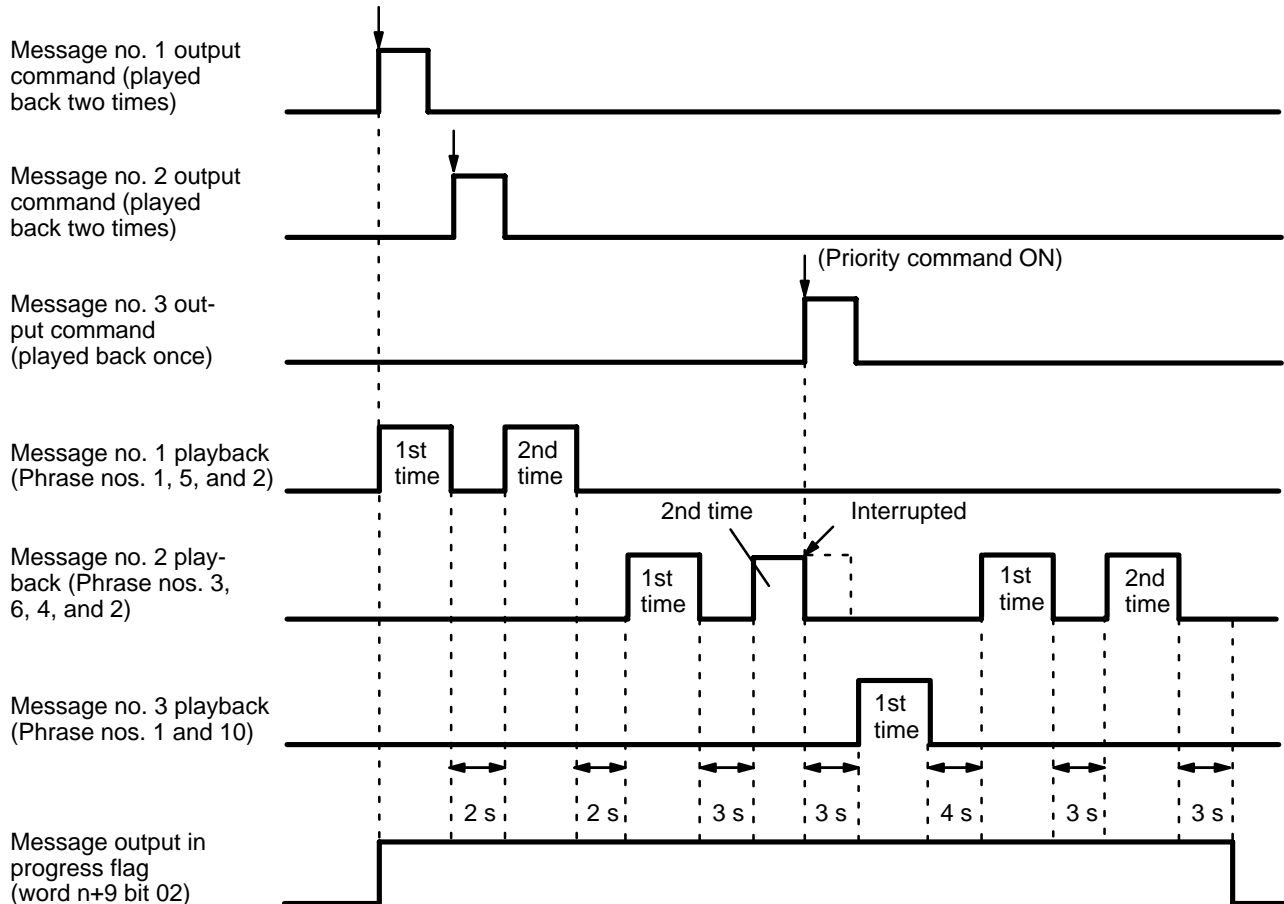

The combination of phrases, the number of repetitions and repeat intervals and the priority command are stored in memory at the leading edge of the output command (point indicated in the figure).

If the priority command is OFF, the messages are played back in the sequence in which their output commands turn ON.

If the priority command is ON, the message specified is played back first. If the priority command turns ON during message playback the message is interrupted and the priority message is played back. The interrupted message is played back again from the beginning when the priority message has been completely played back.

The time that elapses before the next message is played back is the interval time specified by the preceding message.

The message interrupted by the stop command is not played back when the stop command turns OFF. It will only be played back when its output command turns ON again.

When the stop command turns ON during phrase combination message playback, message playback is immediately stopped. Playback remains inhibited while the stop command is ON.

The messages stored in memory are retained even when the stop command turns ON, and are played back when the command turns OFF.

Stop Command (word n bit 15)

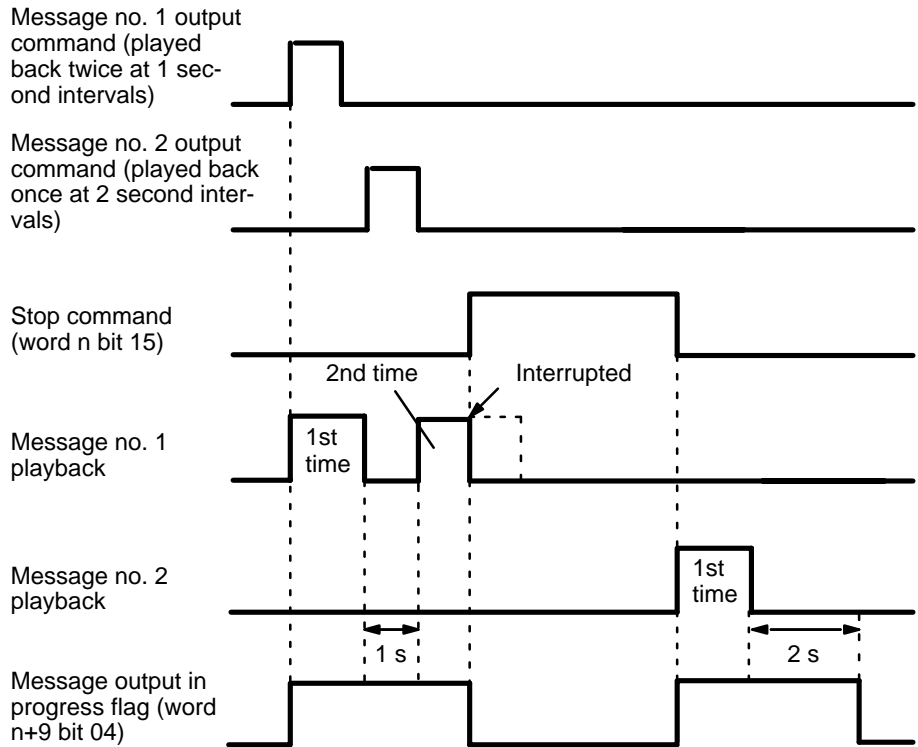

PC Data Transfers

Program Data Transfers

Develop a PC program like the one below when the Voice Unit is used in ON-LINE mode:

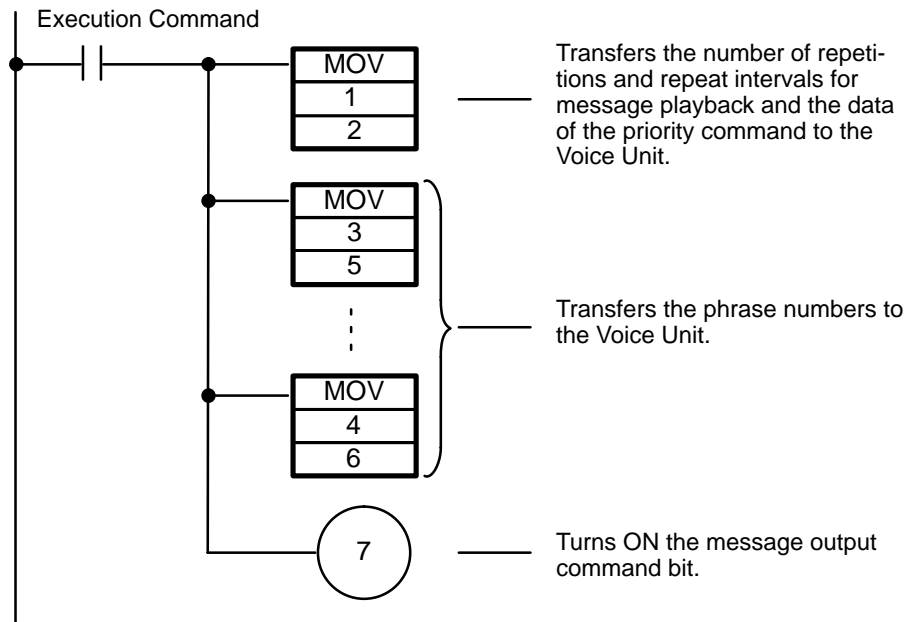

- 1: Number of repetitions, repeat intervals, and priority command
- 2: Word n ($n = 100 + 10 \times \text{unit no.}$)
- 3 and 4: Message No. (2 messages are set per word.)
- 5 and 6: Words n+1 through n+8 (messages 1 through 16)
- 7: Word n bit 14 (message output command bit)

Data and I/O Refresh Timing

Data is transferred between the Voice Unit and PC during PC I/O refreshing.

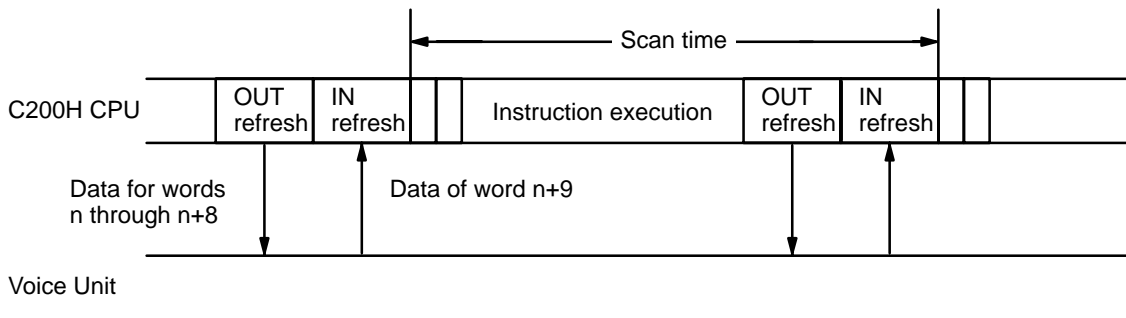

OUT refresh (PC → Voice Unit)

- Number of repetitions
- Repeat intervals
- Priority command
- Output command
- Stop command
- 1st Message No.
- 16th Message No.

The data for the 1st through to the 16th message numbers are only input to the Voice Unit when the output command turns ON.

IN refresh (Voice Unit → PC)

- ON-LINE flag
- Voice Unit busy flag
- Voice Unit busy flag
- Message output in progress flag
- Output storage area FULL flag
- Voice Unit error flag
- Battery error flag

Note The scan time of the PC increases to 4.5 ms when the Voice Unit is used in phrase combination mode.

Flags and I/O Refresh Timing

- ON-LINE flag (word n+9 bit 00)
(valid in ON-LINE mode only)
This flag turns ON when input refreshing begins execution. The ON-LINE flag turns OFF, when the next input refreshing is executed after the Voice Unit has been set to another mode from ON-LINE mode.

- Voice Unit busy flag (word n+9 bit 01) (valid in ON-LINE mode only)

This flag turns ON when output refreshing is executed and the ON status of an output command is recognized, and when subsequent input refreshing in the same I/O refresh area is executed. This flag turns OFF when subsequent output refreshing is executed and the OFF status of the output command is recognized, and when input refreshing in the same I/O area is executed.

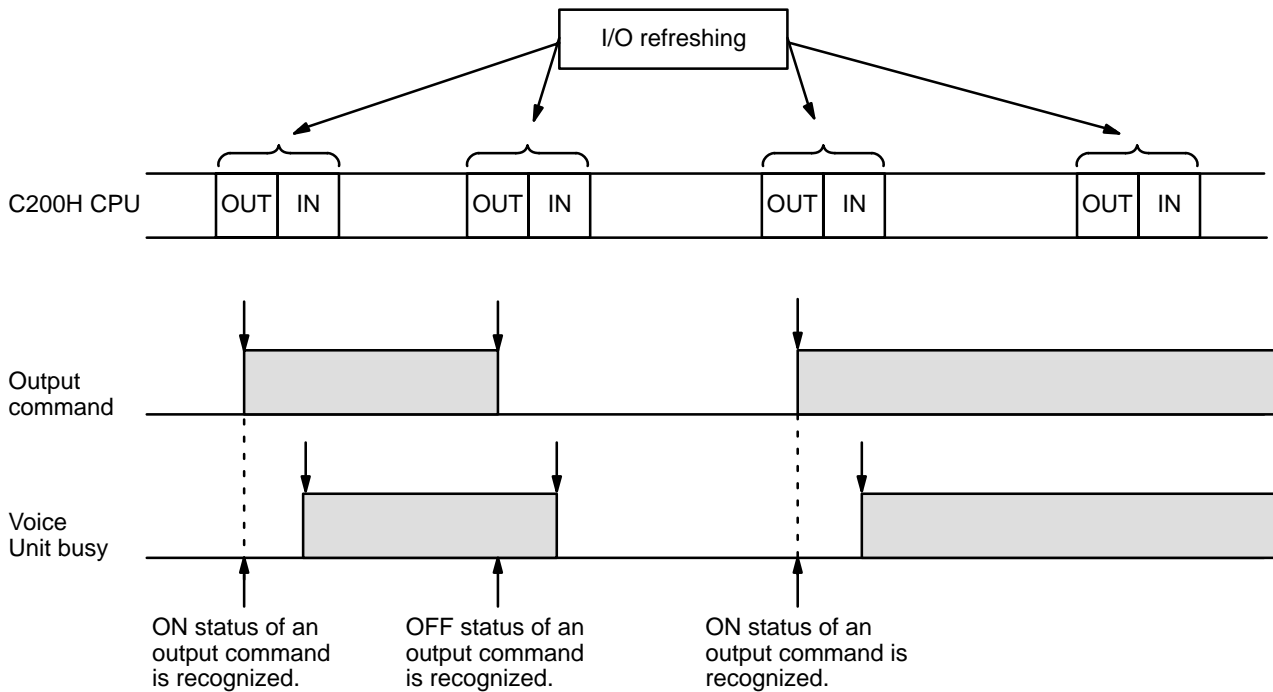

- Message output in progress flag (word n+9 bit 02) (valid in ON-LINE mode only)

This flag turns ON when the input refreshing is executed during message playback. This flag turns OFF when the next input refreshing is executed after the message has been played back and the specified interval time has elapsed.

- Output message area FULL flag (word n+9 bit 03) (valid in ON-LINE mode only)

Up to 20 messages (excluding the message currently being played back) can be stored in this area. Note one message can consist of up to 16 phrases (1 to 16).

When all 20 messages are stored in this area no new messages are accepted, even if the output command of a new message turns ON.

However, when the priority command bit (word n bit 12) turns ON, playback of the current message is stopped and the priority message is transferred to the storage area. It remains stored in the message area until the output command (word n bit 14) turns ON it is played back.

The interrupted message is played back again from the beginning after the priority message has been played back.

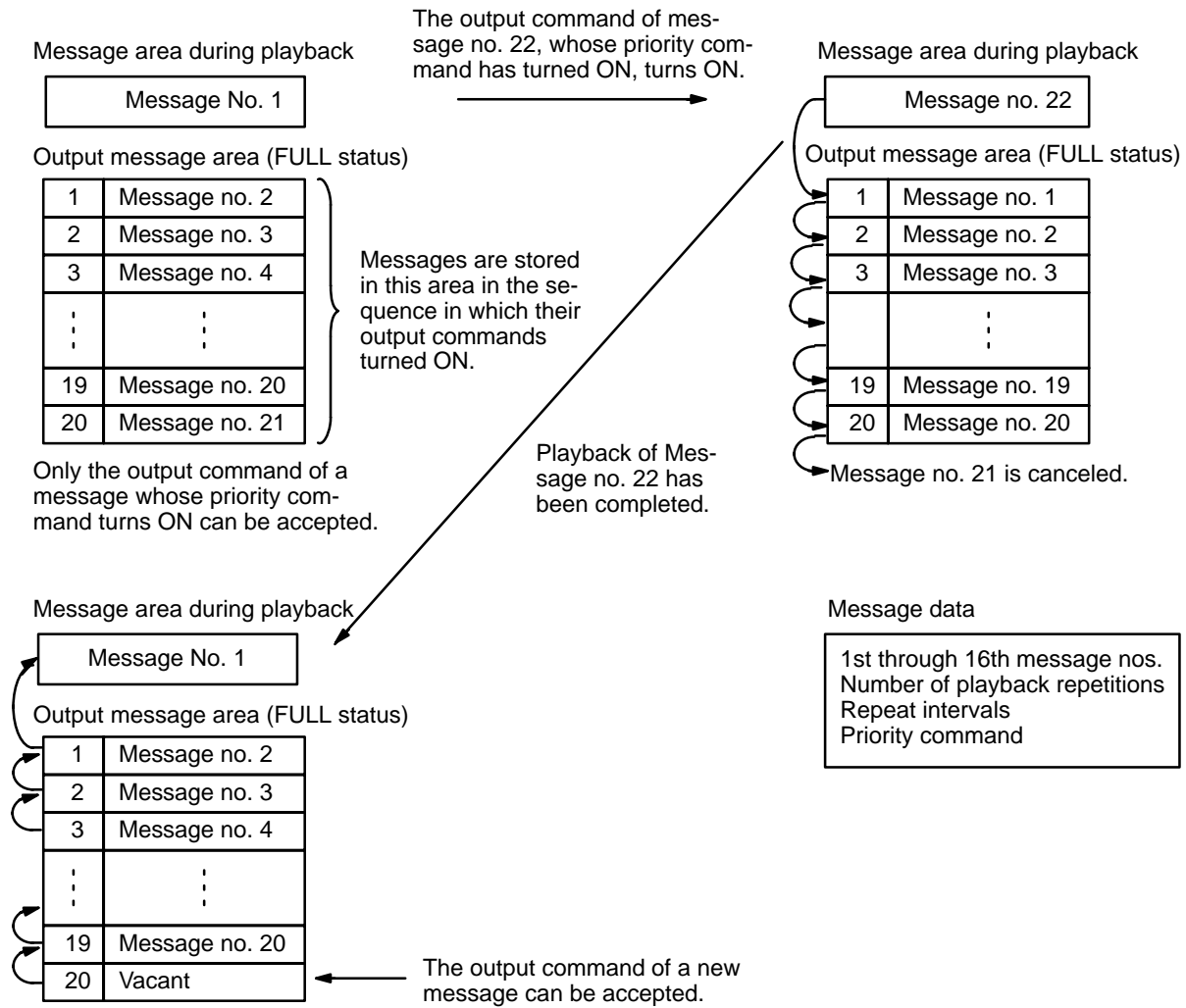

The output message area FULL flag turns ON when an output command is issued during output refreshing, when the number of messages in the message area reaches 20, and when input refreshing in the same I/O area is executed.

The flag turns OFF when the number of messages in the message area decreases to 19 or less and when the next input refreshing is executed.

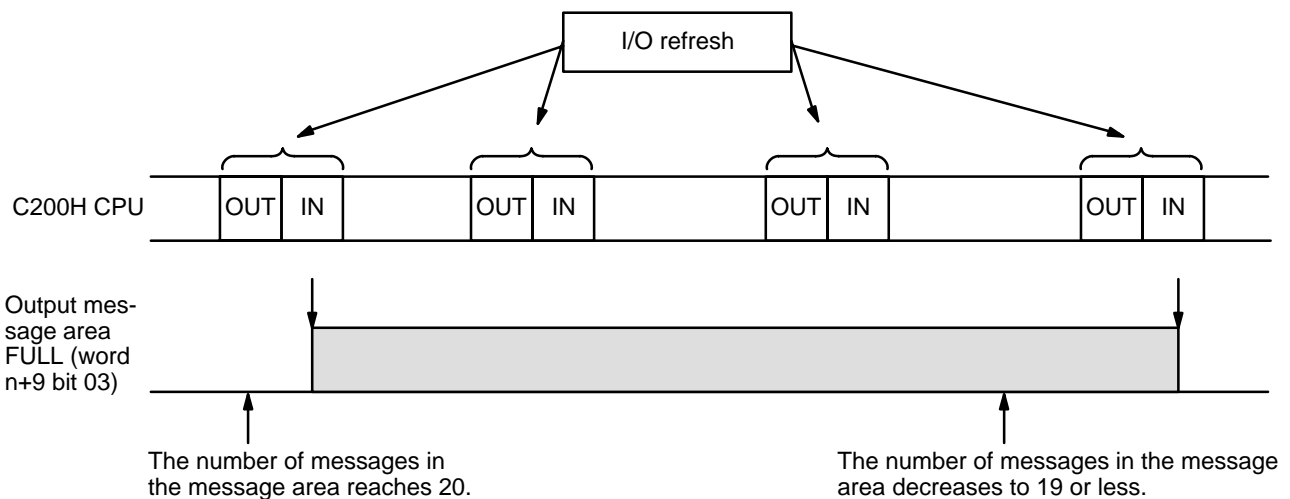

- Voice Unit error flag (word n+9 bit 04)

In modes other than ON-LINE mode:

This flag performs the same operations as that of the ERR indicator. For information on the ERR indicator, refer to 5-1 Error Codes.

This paragraph should be an introduction to the level-1 section briefly explaining the contents and purpose of the section.

In ON-LINE mode:

When the ERR indicator on the Voice Unit is lit (i.e., when an error has occurred in the memory or when no message is recorded), the Voice Unit error flag operates as follows:

The Voice Unit error flag turns ON when the following conditions are met:

- The output refresh is executed.
- The number of repetitions (except F) and repeat intervals at which the message is to be played back are not in BCD.
- The 1st through the 16th message numbers are not in BCD.
- The input refresh in the same I/O are is executed.

When the correct data is received during the subsequent output refreshing, and when input refreshing in the same I/O refresh area is executed, the flag turns OFF.

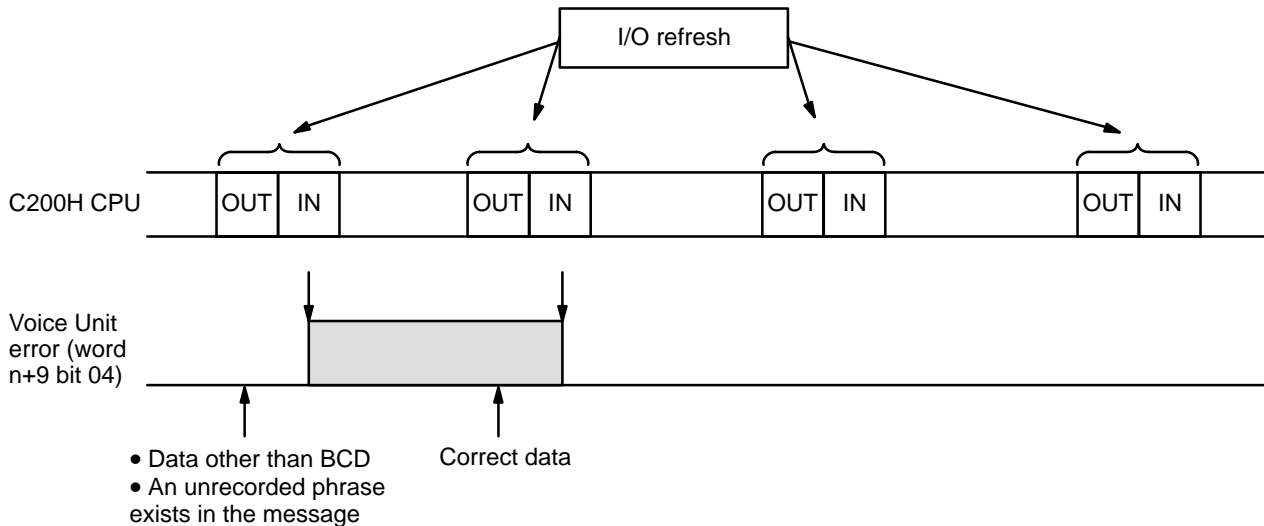

- Battery error flag (word n+9 bit 05) (valid in all modes)

This flag turns ON during input refreshing, when the supply voltage of the battery drops or when the battery is not correctly connected. It turns OFF during input refreshing if the battery has been correctly connected or a new battery has been connected.

3-9 Operations in ON-LINE Mode

Message Output Modes

The following diagram shows the various options for the Message output mode during ON-LINE mode operation.

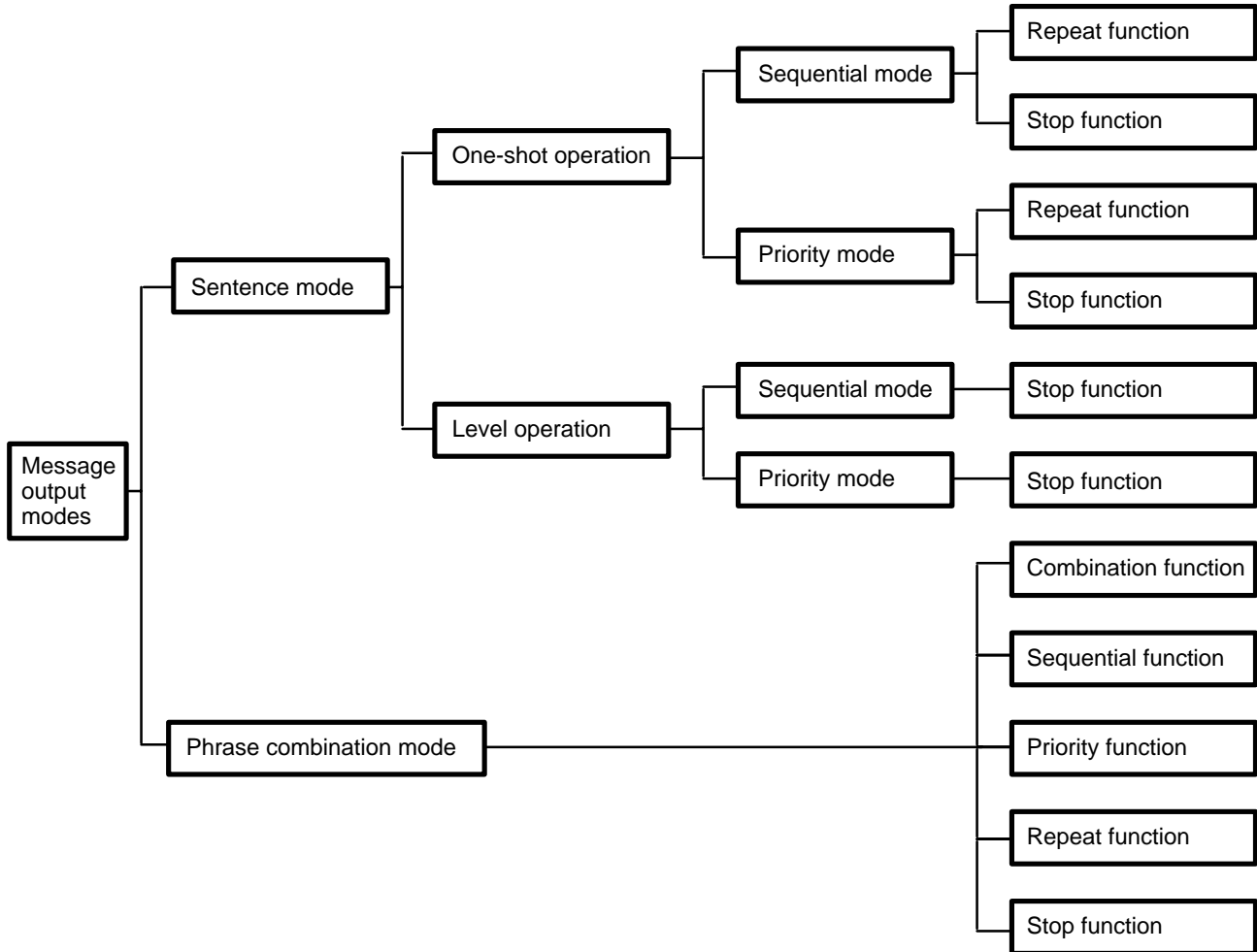

Sentence Mode

In this mode, one sentence represents one message and messages are played back one sentence at a time.

Sentences are stored in the message memory in advance and are played back according to the program.

Item	Function
One-shot operation	Triggered by the leading edge of the output command. One-shot operation plays back messages a specified number of times and at specified time intervals.
Level operation	In Level operation message playback occurs at specified time intervals while the output command is ON.
Sequential mode	Messages are played back in the sequence in which each message's corresponding output command is turned ON.
Priority mode	Messages, whose output commands are turned ON, are played back in the order of lowest to highest message number.
Repeat function	Repeatedly plays back a message a specified number of times and at fixed time intervals.
Stop function	Interrupts and stops message playback by turning ON the stop command.

Phrase Combination Mode In this mode, a message is constructed of several phrases which have been programmed in advance. Phrase set combinations and the sequence in which the phrase sets are played back (as one message) are program controlled.

Item	Function
Combination function	Combines several programmed phrases for playback as one sentence (message).
Sequential function	Plays back a message (combined phrases) only while the output command is ON.
Priority function	Gives priority to a combination of phrases and plays them back only while the priority command is ON.
Repeat function	Repeatedly plays back a message a specified number of times at specified time intervals.
Stop function	Interrupts message playback by turning ON the stop command.

Note For details, refer to 3-2 Operating Procedure.

3-10 Mixing Function

The Voice Unit has a function that directly connects the message input jack to the output jack when the mixing switch is turned ON in a modes other than REC mode.

Connect a microphone to the input jack to use the Voice Unit as a simple broadcasting system.

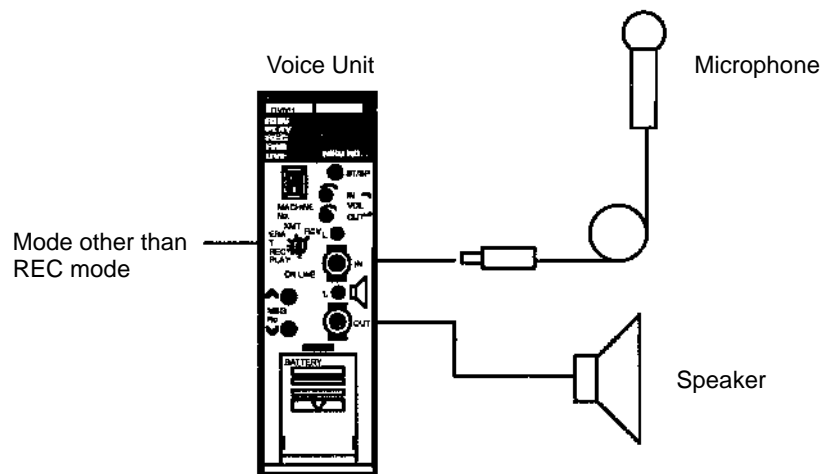

In this case, the speaker message output is a mixture of the recorded message and input message.

Sharing one speaker with several Voice Units

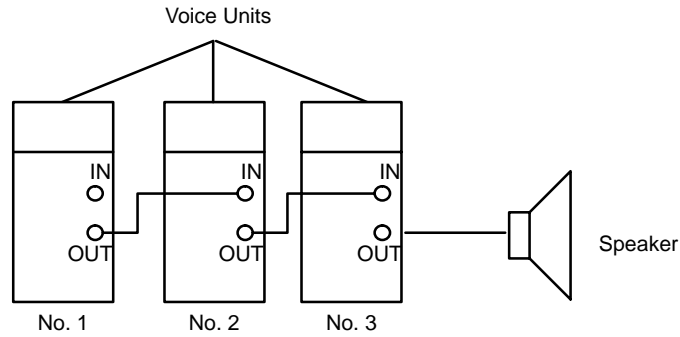

In the above diagram the speaker output a message which is a mixture of the messages of the Voice Unit 1 through 3.

To interconnect two or more Voice Units connect the message output jack of one Voice Unit to the message input jack of another.

For the situation shown in the above diagram set the line/speaker selector switch of Unit 1 and 2 to the speaker side. Set the selector switch of Unit 3 according to the device connected to the Unit3.

Set the microphone/line selector switch of Units 2 and 3 to the L side.

The message level output of the first Unit is attenuated by the second and third Units. To adjust the message output level, use the output volume controls of the second and third Units.

A maximum of three Voice Units can be interconnected.

SECTION 4

Example Programs

4-1	Sentence Mode Example Programs	60
4-2	Phrase Combination Mode Example Programs	65

4-1 Sentence Mode Example Programs

This section describes how to develop PC programs for Voice Unit message playback when the Voice Unit is under PC control (ON-LINE mode).

For the following programs it is assumed that the Voice Unit has been mounted on the PC as follows:

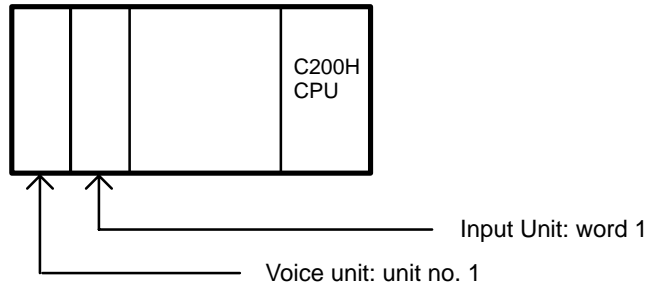

Example 1: One-shot operation

In this example, the number of repetitions and the repeat intervals for message playback are fixed.

Message no. 2 is played back when input 00100 turns ON.

Message no. 6 is played back when input 00101 turns ON.

The messages are played back 3 times at 1.0 second intervals

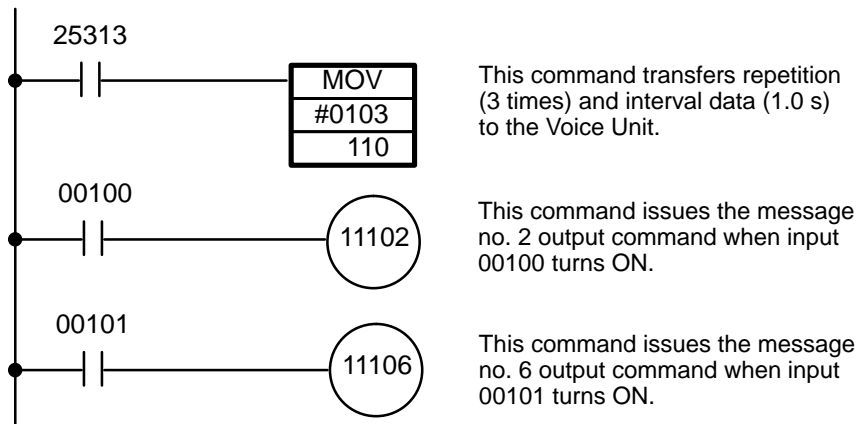

Sequential mode response

In sequential mode the messages corresponding to inputs 00100 and 00101 are played back in the sequence in which their inputs turn ON.

If the two inputs turn ON in the same scan time, the message having the lower number (message no. 2) is played back first.

Priority mode response

If the output command of message no. 2 turns on during message no. 6 playback message no. 2 takes priority. As a result message no. 6 is interrupted and message no. 2 is played back.

Message no. 6 is played back from the beginning again after message no. 2 has been played back.

Example 2: One-shot operation

In this example, the number of repetitions and the repeat intervals are different for each message.

Message no. 1 is played back when input 00100 turns ON.

Message no. 3 is played back when input 00101 turns ON.

Message playback is interrupted while input 00102 is ON.

The number of repetitions and interval times of each Message no. are as follows:

	Message no. 1	Message no. 3
Number of repetitions	2 times	3 times
Repeat intervals	0.5 s	1.0 s

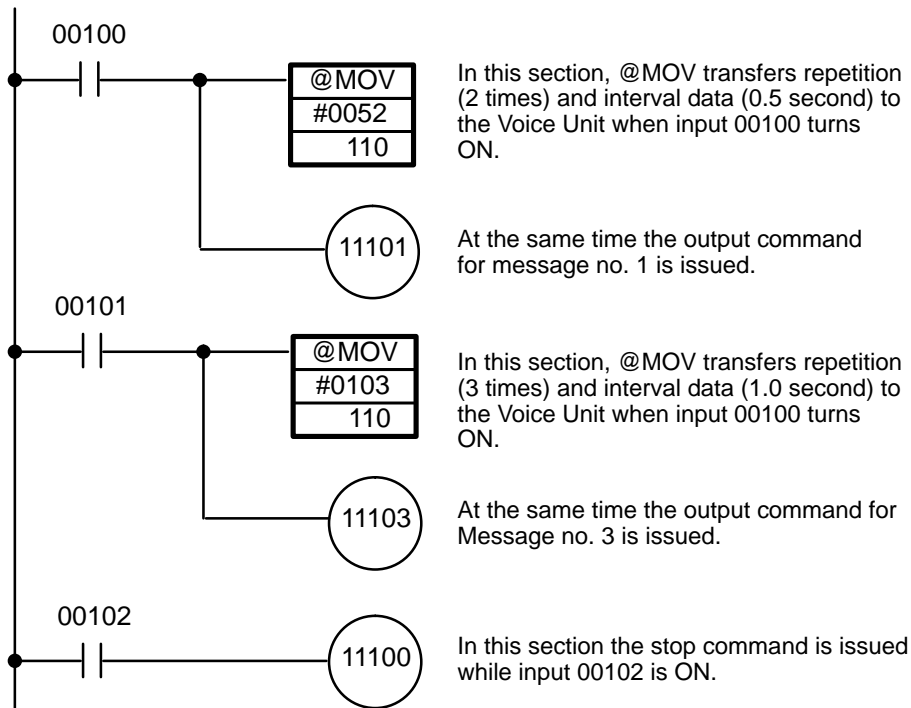

Note In the above program, if inputs 00100 and 00101 turn ON during the same scan time, then both messages are played back under the data conditions of the last programmed message. Therefore in this example the last programmed message is Message no. 3 and therefore both messages are played back 3 times and at 1.0 second intervals.

If the above possibility (that the inputs turn ON during the same scan time) exists, then use program example 3.

Example 3: One-shot operation

In this example, more than one output command turns ON during the same scan time.

Message no. 18 is played back when input 00100 turns ON.

Message no. 32 is played back when input 00101 turns ON.

The number of repetitions and repeat intervals are as follows:

	Message no. 18	Message no. 32
Number of repetitions	4 times	6 times
Repeat intervals	1.5 s	2.5 s

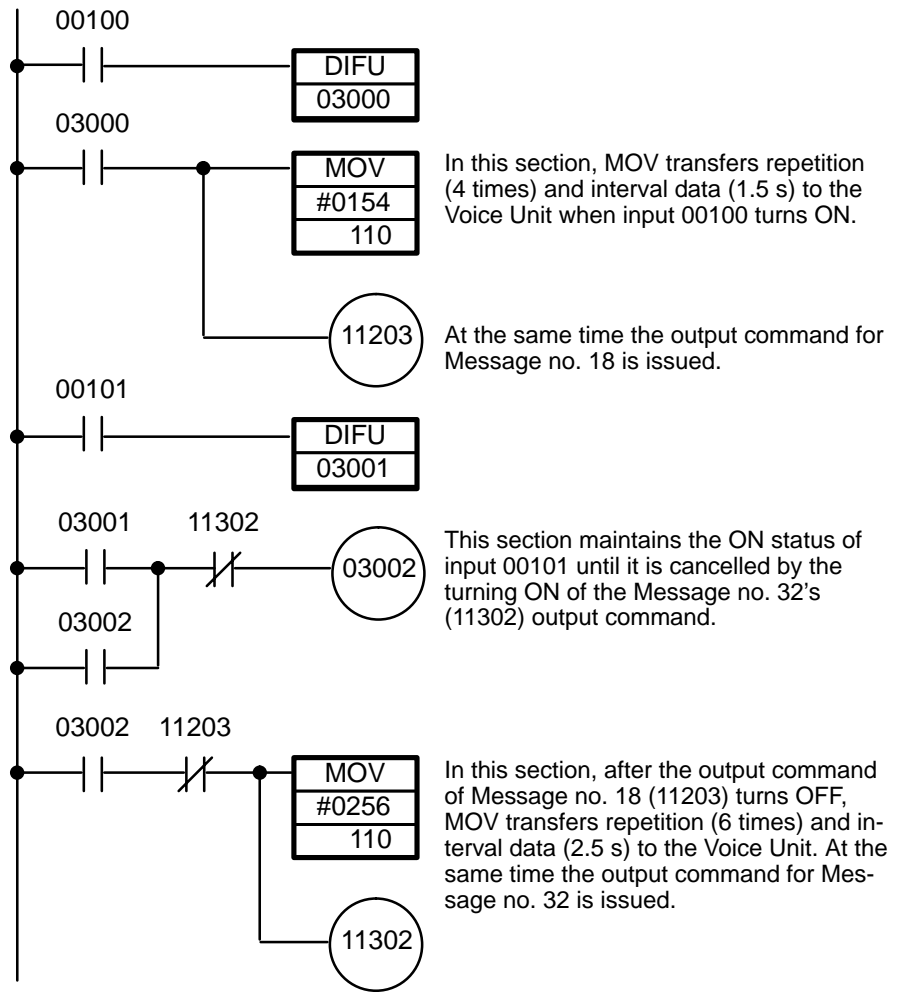

Example 4: One-shot operation

In this example, the Voice Unit is mounted on a Remote I/O Slave Backplane.

Note that, when the Remote I/O transfer time is shorter than the PC's scan time and a differential instruction is used, the Voice Unit may not operate normally.

Message no. 9 is played back three times at 2.0 second intervals when input 00100 turns ON.

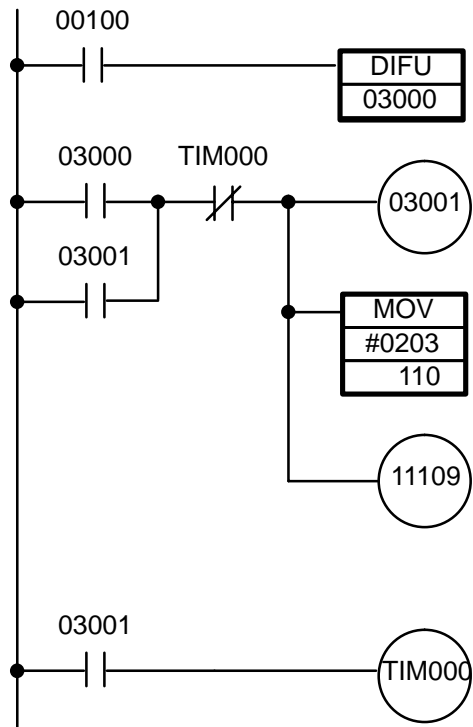

In this section while TIM00 is OFF (time not up) the ON status of input 00100 is maintained. During this time the transfer of data and message no. 9's output command to the Voice Unit occurs. The transfer is terminated when TIM000 turns ON (time up).

Timer value > Transfer time + Scan time (max.)

Example 5: One-shot operation in sequential mode

In this example, the output storage area becomes full.

Message no. 21 is played back two times at 1.0 second intervals when input 00100 turns ON.

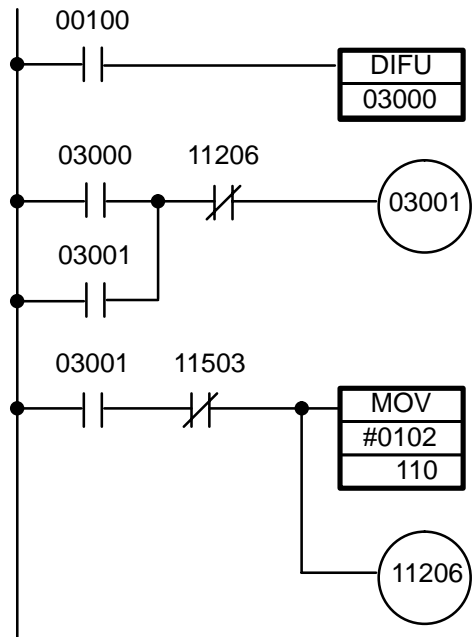

This section maintains the ON status of input 00100 until it is canceled by the turning ON of message no. 21's output command (11206)

This section only transfers the number of repetitions and repeat intervals to the Voice Unit when the output message area FULL flag (11503) is ON; at the same time Message no. 21's output command is issued.

Example 6: One-shot operation in sequential mode

In this example an Input Unit is assigned to word 1 and unit no. 1 is assigned to the Voice Unit.

Message no. 12 is played back when input 00100 turns ON.

Message no. 7 is played back when input 00101 turns ON.

Message no. 25 is played back when input 00102 turns ON.

Message playback is stopped when input 00103 is ON.

The number of repetitions and repeat intervals are as follows:

	Message no. 12	Message no. 7	Message no. 25
Number of repetitions	3 times	Continuously	5 times
Repeat intervals	0.2 s	0.5 s	1.0 s

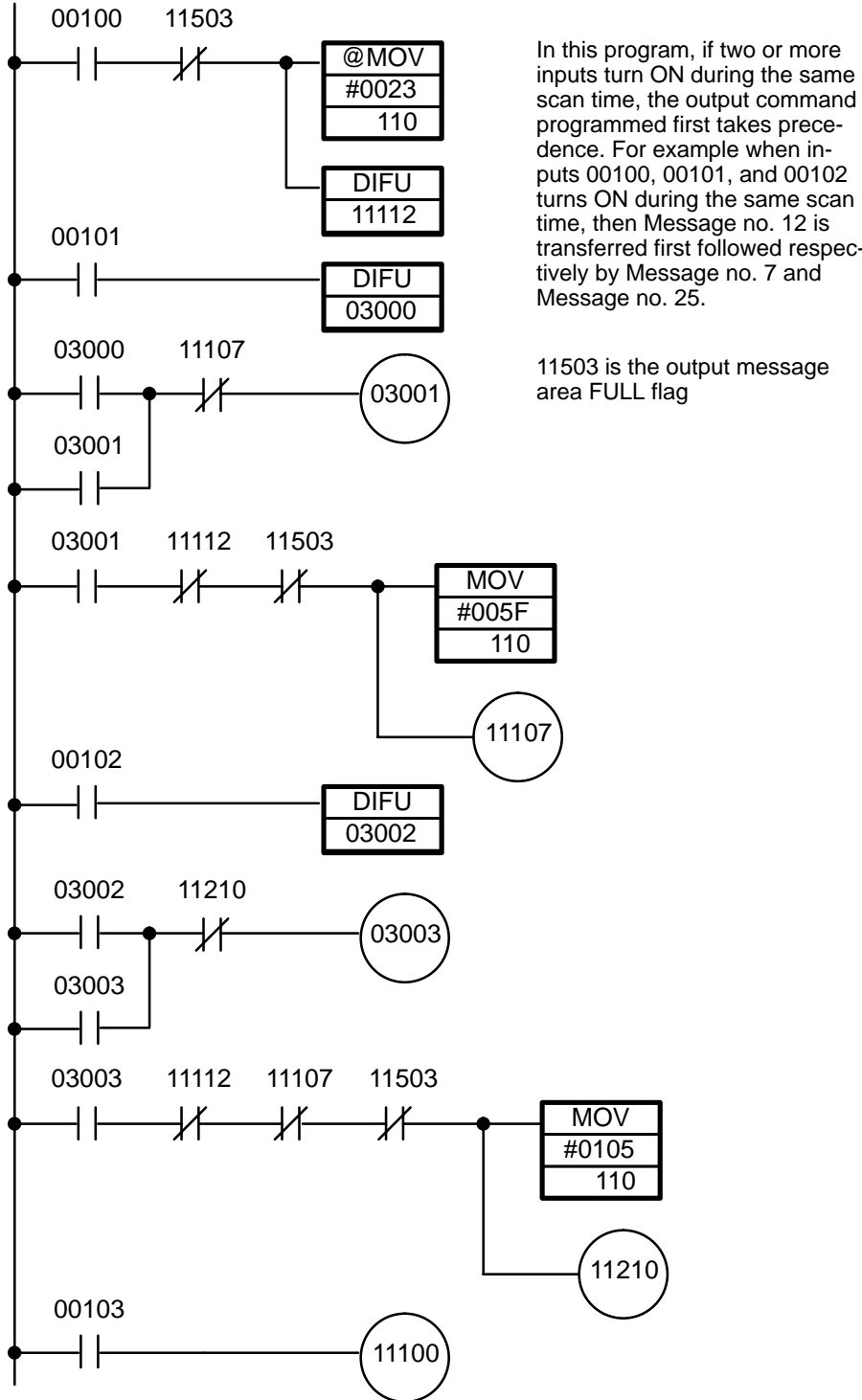

Example 7: Level operation Message no. 16 is played back while input 00100 is ON.
 Message no. 33 is played back while input 00101 is ON.

Message playback is stopped while input 00102 is ON.
 The messages are played back at 0.5 second intervals.

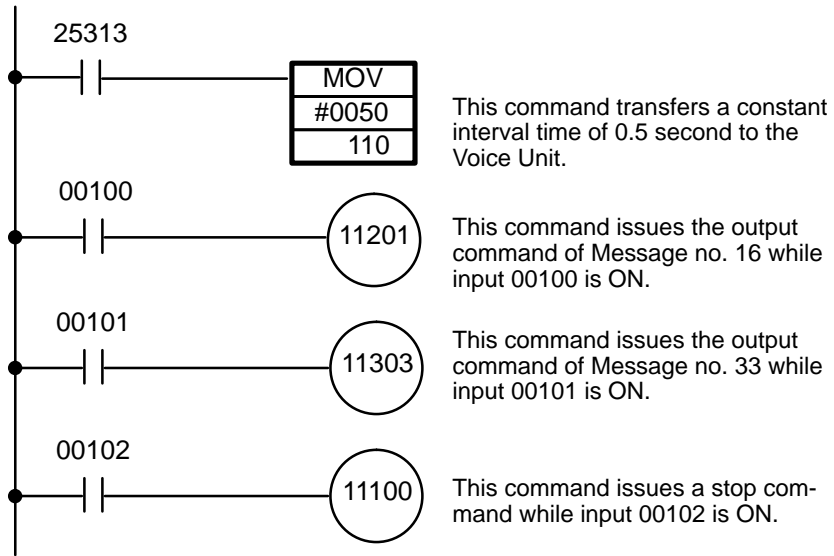

In sequential mode

In sequential mode Message nos. 16 and 33 are alternately played back once while both inputs 00100 (output command for Message no. 16) and 00101 (output command for Message no. 33) are ON.

In priority mode

In priority mode the output command of Message no. 16 takes precedence over that of Message no. 33. Therefore while the output command of Message no. 16 is ON, Message no. 33 is not played back, even if its output command turns ON.

4-2 Phrase Combination Mode Example Programs

In the following examples it is assumed that the Voice Unit is mounted on the CPU Backplane as follows:

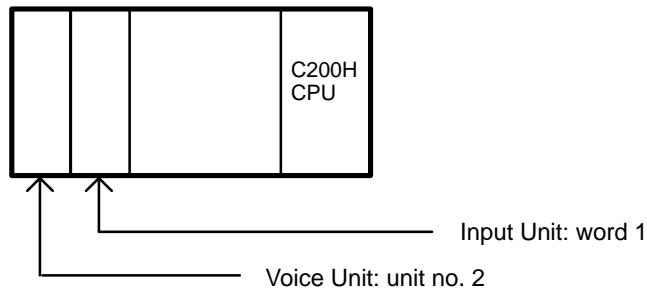

Example 1:

In this example, one phrase number is specified at a time while the Voice Unit is in sequential mode.

Phrases 5, 17, and 31 are combined and played back three times at 0.3 second intervals when input 00100 turns ON.

Phrases 7, 17, and 31 are combined and played back three times at 0.3 second intervals when input 00101 turns ON.

Message playback is stopped while input 00102 is ON.

The following phrases are assigned to each Phrase no.:

Phrase no. 5 = "Unit 5"

Phrase no. 7 = "Unit 7"

Phrase no. 17 = "Requires"

Phrase no. 31 = "Materials"

Note If the number of phrases used is less than 16, set the last Phrase no. to "00".

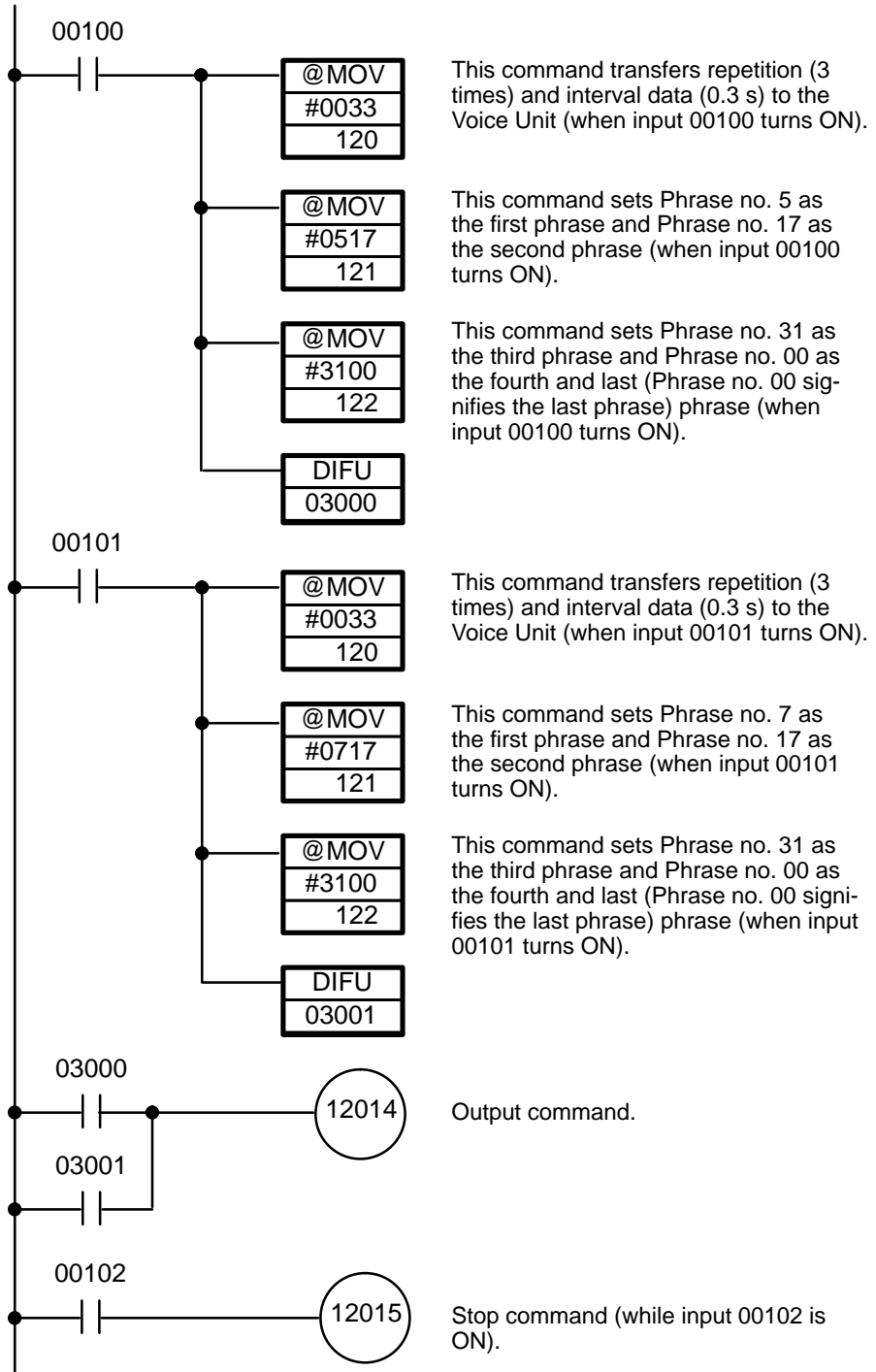

The messages, for the above program, are issued as follows:

When input 00100 turns ON, the message “Unit 5 requires materials” is issued three times at 0.3 second intervals. When input 00101 turns ON, the message “Unit 7 requires materials” is issued three times at 0.3 second intervals.

Note In this example, when two inputs turn ON during the same scan time, only the data in the latter part of the program is output. To avoid this, use the program shown in Example 4.

Example 2:

In this example, one phrase number is specified at a time and the priority function is used.

Phrase nos. 2, 20, and 35 are combined and played back two times at 1.0 second intervals when input 00100 turns ON.

Phrase nos. 3, 20, 13, and 42 are combined and played back continuously at intervals of 0.2 seconds. This latter combination of the phrases takes precedence over all other phrase combinations.

The following phrases are assigned to each Phrase no.:

Phrase no. 2 = “no. 2”

Phrase no. 3 = “no. 3”

Phrase no. 13 = “Has”

Phrase no. 20 = “Tank”

Phrase no. 35 = “Needs Water”

Phrase no. 42 = “A Problem”

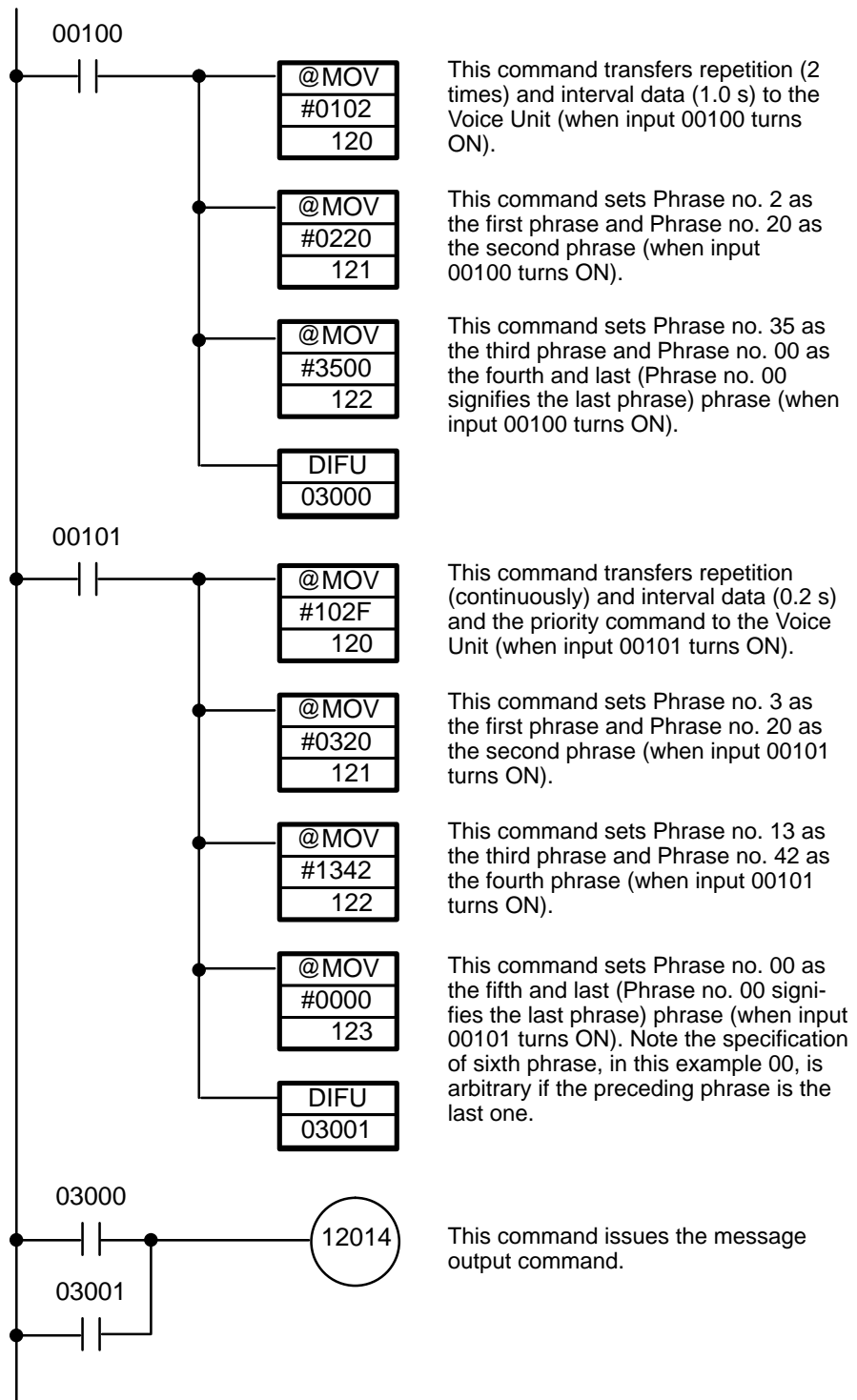

The messages, for the above program, are issued as follows:

When input 00100 turns ON, the message “No. 2 Tank Needs Water” is played back twice at 1.0 second intervals.

When input 00101 turns ON, the message “No. 3 Tank Has A Problem” is played back continuously at 0.2 second intervals. This message takes precedence over the other message.

To stop the continuous playback of a message turn ON the stop command.

Example 3: In the following program, phrases are registered in the read-only DM area (DMs 1000 through 1999).

Register the following data in the DM area (starting from DM 1000) via the Programming Console:

	Phrase Combination	Number of playback combinations	Repeat interval
Phase no. 1	no. 3 + no. 10 + no. 22	5 times	2.0 s
Phase no. 2	no. 12 + no. 46 + no. 35 + no. 50	2 times	1.5 s

The DM area is to be assigned as follows:

DM no.	Data	Contents
DM 1000	0205	Repeat intervals and number of repetitions
DM 1001	0310	Phrases nos. 3 and 10
DM 1002	2200	Phrase no. 22 and the message end code (00)
DM 1003	0152	Repeat intervals and number of repetitions
DM 1004	1246	Phrases nos. 12 and 46
DM 1005	3550	Phrases nos. 35 and 50
DM 1006	0000	End code (00)

Message no. 1 (DM 1000-1002)
Message no. 2 (DM 1003-1006)

Program

When input 00100 turns ON, Message no. 1 is played back.

When input 00101 turns ON, Message no. 2 is played back.

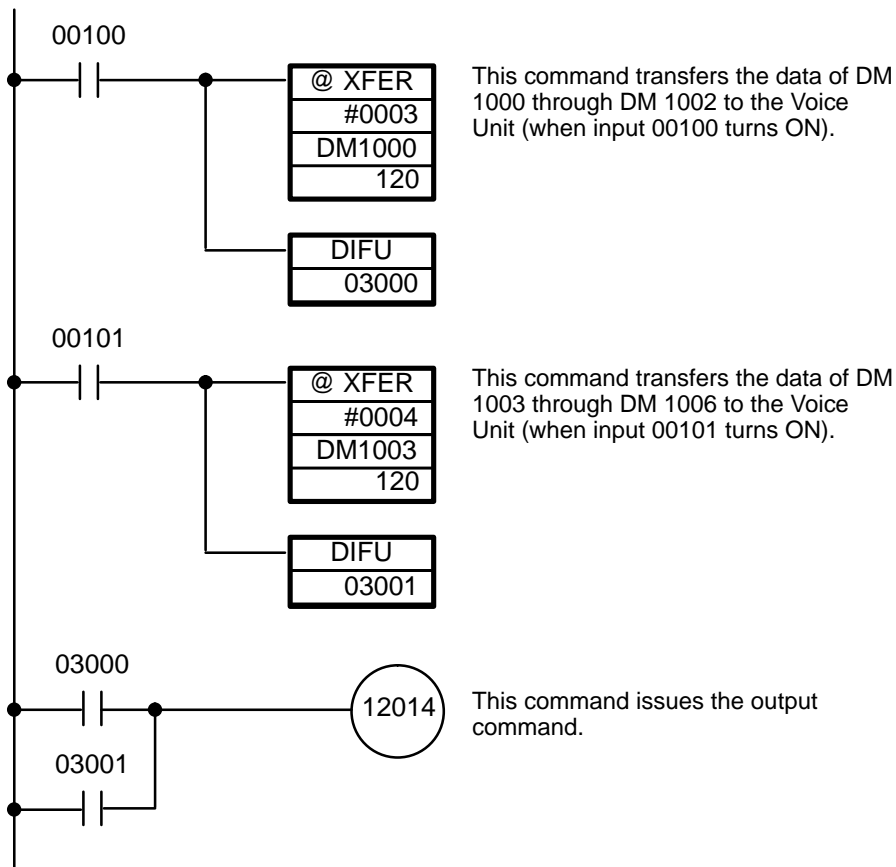

Note In the above program, when two inputs turn ON during the same scan time, only the data of the latter part of the program is output. To avoid this, use a program like the one shown in Example 4.

Example 4:

In the following example, the output commands of two or more messages turn ON within two scan repetitions.

Phrase nos. 1 and 10 are combined and played back twice at 0.5 second intervals when input 00100 turns ON.

Phrase nos. 19 and 30 are combined and played back five times at 1.0 second when input 00101 turns ON.

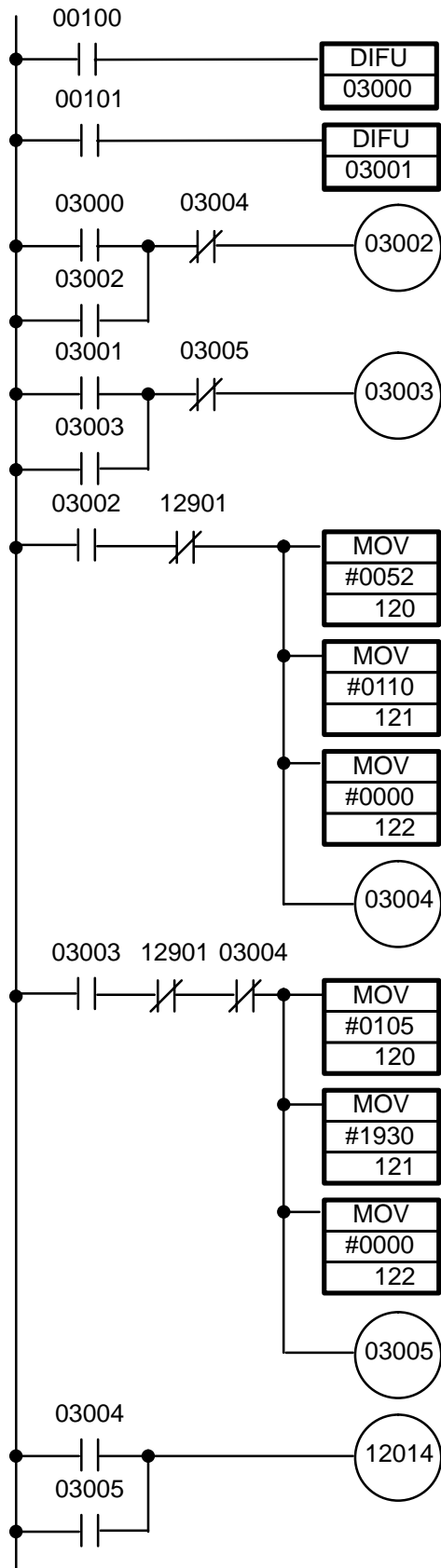

This command transfers the combination of Phrase nos. 1 and 10 to the Voice Unit when the Voice Unit busy flag (12901) is OFF.

This command transfers the combination of Phrase nos. 19 and 30 to the Voice Unit when the Voice Unit busy flag (12901) and 03004 turn OFF (03004 turns ON when the combination Phrase nos. 1 and 10 are transferred).

Output command

Example 5: In the following example, the Voice Unit is mounted on a Remote I/O Slave Rack.

Note The Voice Unit may not operate correctly if the Remote I/O transfer time is longer than the PC's scan time and a differential instruction is used in the program. Phrase nos. 8, 12, and 26 are combined and played back four times at 2.5 second intervals when input 00100 turns ON.

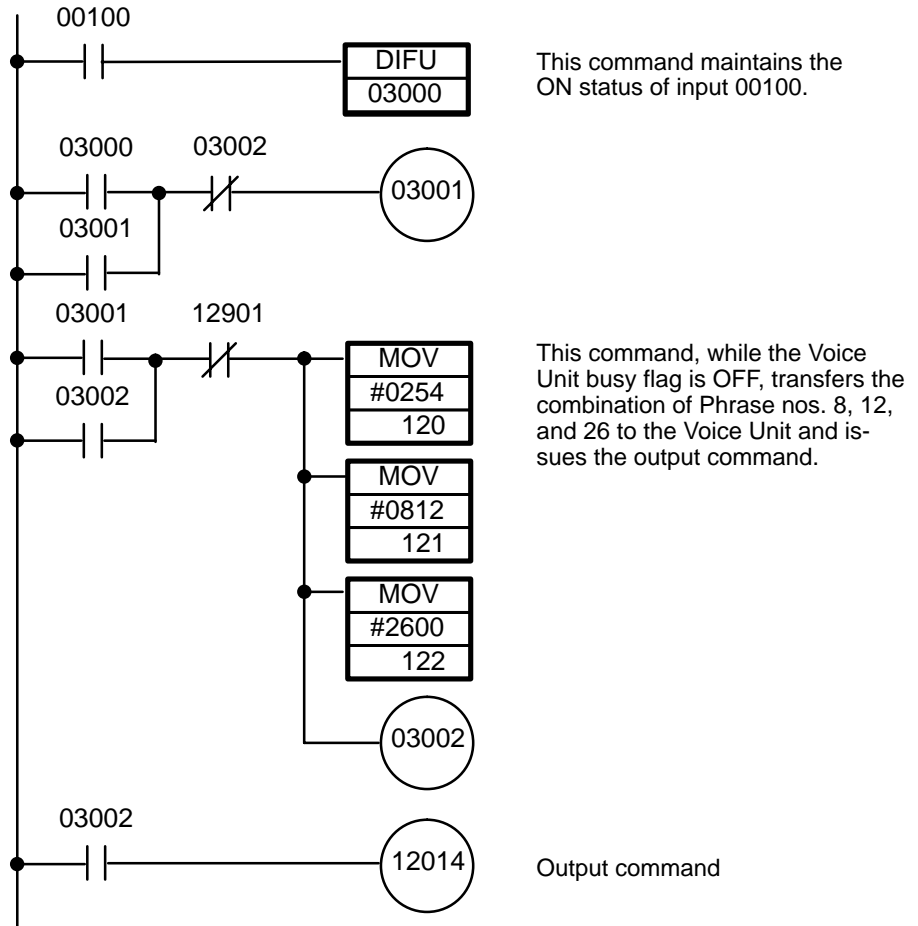

Example 6: In the following example, the output message area becomes full.

Phrase nos. 20, 7, and 11 are combined and played back twice at 3.0 second intervals when input 00100 turns ON.

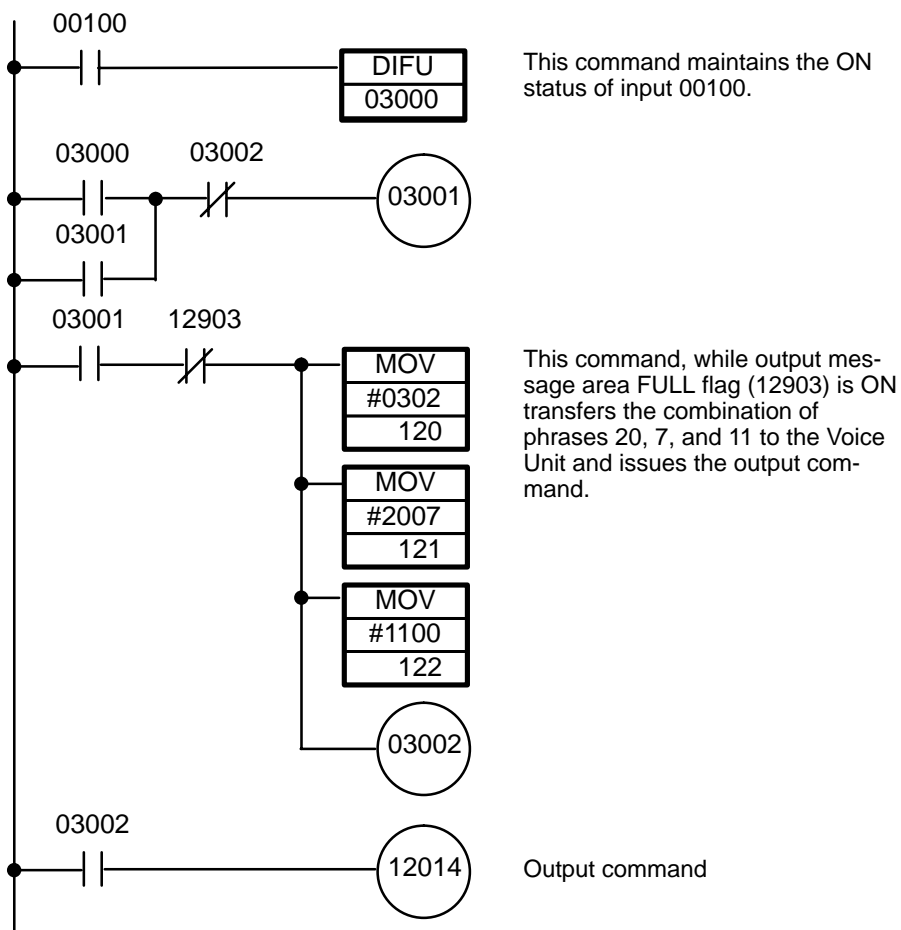

Example 7: This program example is for phrase combination mode

In the following example, it is assumed that the Input Unit is assigned to word 1, and that the Voice Unit is assigned unit no. 2.

	Input	Phrase Combination	Repeat interval	Number of repetitions	Priority command
Message no. 1	00100	no. 2 + no. 5 + no. 16	0.5 s	2 times	ON
Message no. 2	00101	no. 10 + no. 6 + no. 38	0.2 s	5 times	OFF
Message no. 3	00102	no. 9 + no. 48	1.0 s	6 times	OFF
Stop command	00103	---	---	---	---

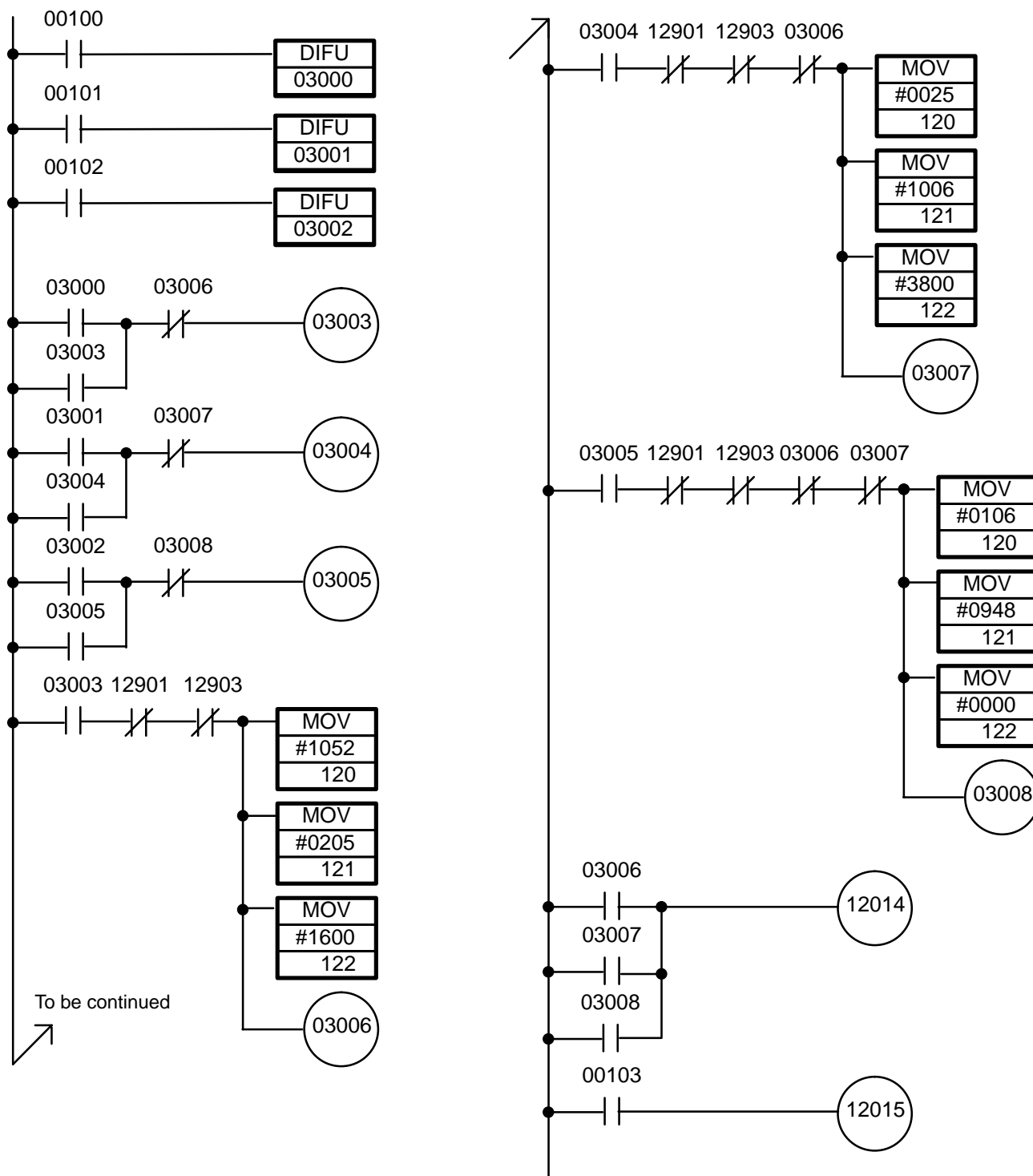

In this program, when two inputs turn ON during the same scan time, the part programmed first takes precedence. For example when inputs 00100, 00101, and 00102 turn ON during the same scan time, the data for Message no. 1 is transferred first followed respectively by Message nos. 2 and 3.

- 12901: Voice Unit busy flag
- 12903: Output message area FULL flag

Example 8: In this example, two Voice Units are used to combine phrases.

It is assumed that the Voice Units are mounted on the CPU Backplane as follows (for connection details refer to 3-10 Mixing Function).

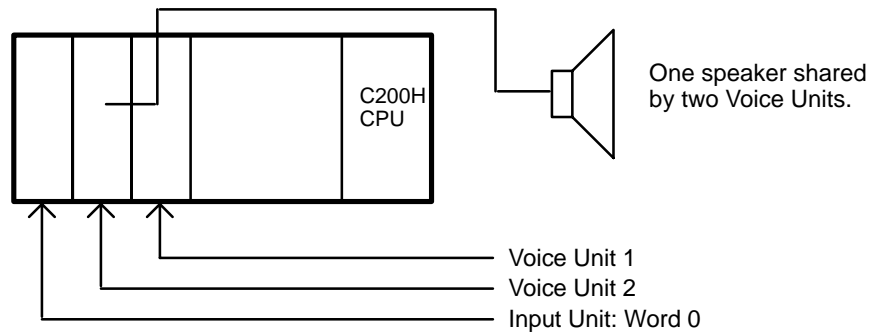

When input 00100 turns ON, Phrase nos. 5 and 11 of Voice Unit 1, and Phrase nos. 20 and 8 of Voice Unit 2 are combined and played back once at intervals of 0.0 seconds.

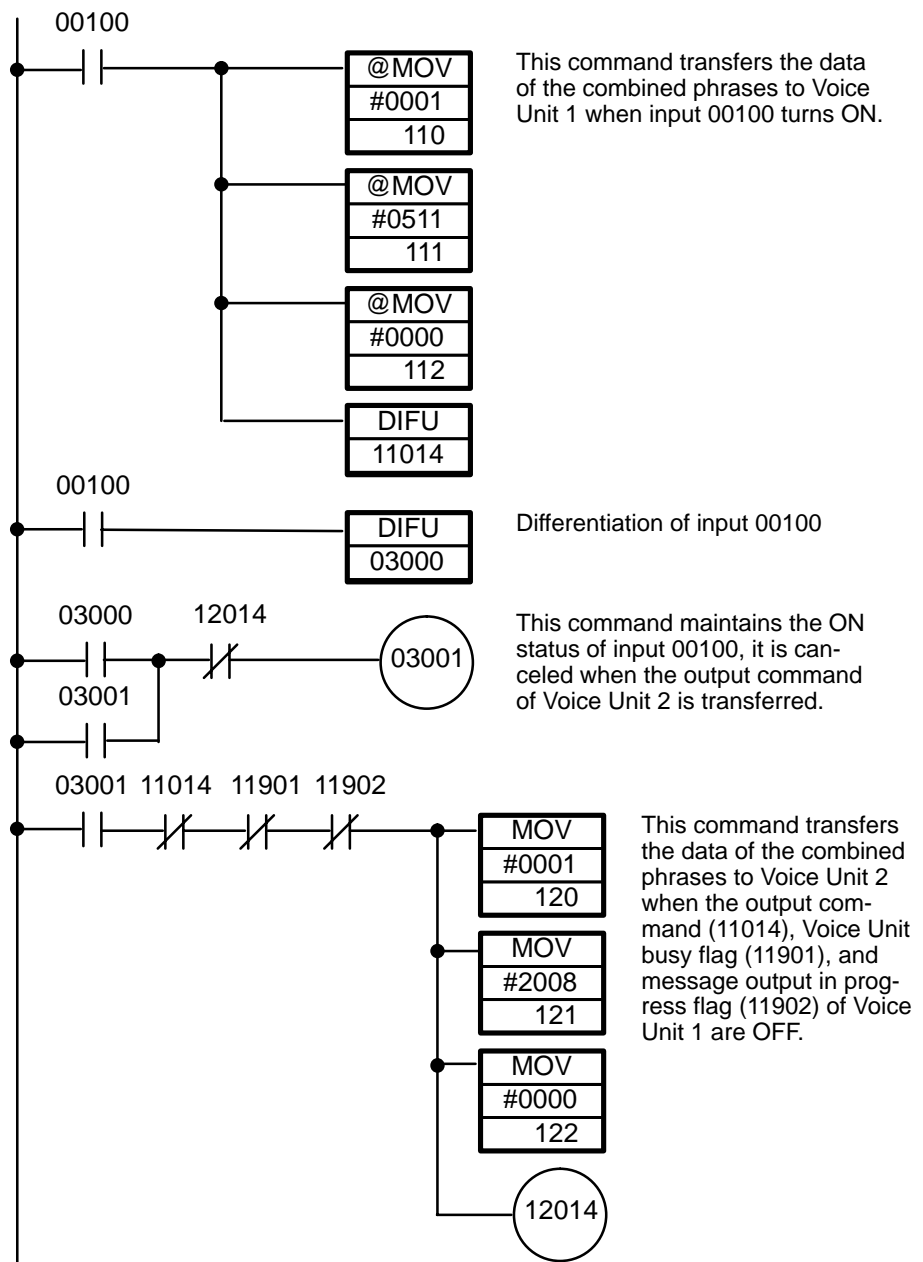

When input 00100 turns ON, Phrase nos. 5 and 11 of Voice Unit 1 and Phrases nos. 20 and 8 of Voice Unit 2 are combined in this order and played back.

Note Do not transfer any other combinations of phrases until input 00100 turns ON and the data of this program has been completely transferred. To execute this program, messages must not be stored in the output message areas of the Voice Units.

Connect the output jack of Voice Unit 2 to the input jack of Voice Unit 1, and then connect the output jack of Voice Unit 1 to a speaker. (Refer to 3-10 Mixing Function.)

Notes on Program Development

When one-shot operation is executed in sentence mode and phrase combination mode, the message is recognized at the leading edge of the output command. Therefore be sure to turn OFF the output command once and then back ON again to transfer a new message.

To use an I/O refresh instruction, confirm that at least 3 ms elapse between I/O refresh operations; otherwise, the output command of a message may not be input to the Voice Unit.

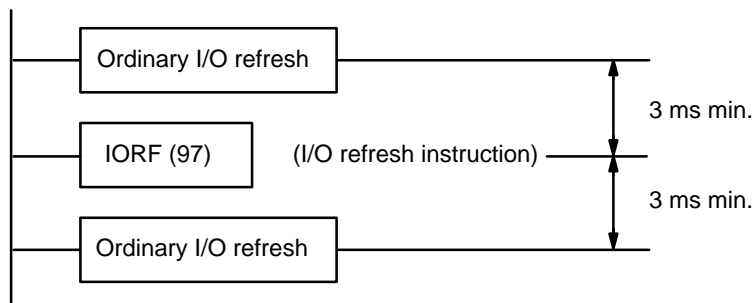

SECTION 5

Troubleshooting

5-1	Error Codes	80
5-2	Troubleshooting	85





5-1 Error Codes

If an error occurs in the Voice Unit the ERR indicator on the front panel is lit or blinking. The following table lists error indications and error codes which may be displayed on the MSG No. indicator.

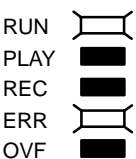
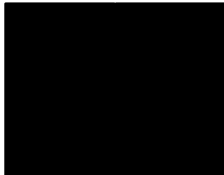
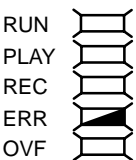
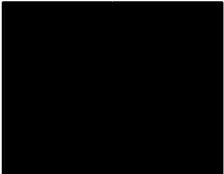
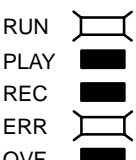
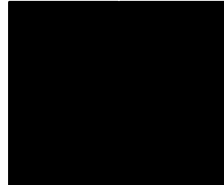









Error indications for all modes





Error indication

Display	Possible Cause	Correction
  <p>All indicators are unlit.</p>	<p>Refreshing between the PC and Voice Unit was not performed normally (Special I/O Unit error). In this situation, only the Voice Unit stops operation.</p>	<p>Remove the cause of the error, and restart the Voice Unit by turning the AR bit 0100 through 0109 corresponding to the Unit ON and then back OFF again. If the Unit doesn't function properly after it has been restarted, replace the Unit.</p>
<p>All indicators are unlit.</p>	<p>The PC has no power supplied to it.</p>	<p>Supply power to the PC.</p>
	<p>The Voice Unit is not secured properly on its Backplane.</p>	<p>Correctly mount the Voice Unit on the Backplane.</p>
	<p>One of Special I/O Units is defective. In this situation the PC does not operate.</p>	<p>Replace the defective Special I/O Unit. The defective Unit is indicated as \$ when the PC I/O table is read.</p>
<p>Two or more system Special I/O Units have been assigned duplicate unit numbers (I/O UNIT OVER). In this situation, the PC does not operate.</p>	<p>Assign the correct unit numbers. The unit numbers can be checked by reading the PC I/O table.</p>	
  <p>The ERR indicator is blinking at 0.5 second intervals. The other indicators may be lit, blinking or unlit depending on the mode.</p>	<p>The battery connector is disconnected; or, a battery is not connected.</p>	<p>Connect the battery to the connector correctly.</p>
<p>The ERR indicator is blinking at 0.5 second intervals. The other indicators may be lit, blinking or unlit depending on the mode.</p>	<p>The supply voltage of the battery has dropped.</p>	<p>Replace the battery.</p>
  <p>The RUN and ERR indicators are lit. The other indicators are unlit.</p>	<p>The mode selector is not in a correct position (it is set to a position other than ON-LINE, PLAY, REC, T, ERA, XMT, and RCV).</p>	<p>Set the mode selector to the correct position.</p>

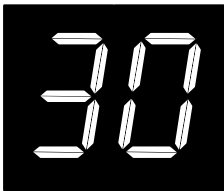





Note  : lit,  : blinking at 0.5 s intervals,  : blinking at 0.2 s intervals
 : blinking at high speed





Errors in REC mode

Display	Possible Cause	Correction
<p>RUN </p> <p>PLAY </p> <p>REC </p> <p>ERR </p> <p>OVF </p> 	<p>A different recording time has been specified (by the DIP switch on the back panel).</p>	<p>Match the recording time of the message data (recorded message) with the recording time set by the DIP switch on the back panel.</p>
<p>The RUN and ERR indicators are lit. The other indicators are unlit.</p>	<p>The message memory has failed.</p>	<p>Either clear the error code in ERA mode or rewrite message data in the RCV mode.</p>
<p>RUN </p> <p>PLAY </p> <p>REC </p> <p>ERR </p> <p>OVF </p> 	<p>The memory protect switch is in the ON position (this will be true if the error indication is made when the mode selector switch is operated or when the ST/SP switch is pressed).</p>	<p>Turn OFF the memory protect switch and press the ST/SP switch to record the message.</p>
<p>The RUN and ERR indicators are lit. The REC indicator is blinking at 0.5 second intervals. The LED display a message number.</p>	<p>No recording time remains because the message memory is filled with data. Or all available messages (1 through 60) have been recorded (in this case the recording time may not be 0).</p>	<p>In this state no new messages can be recorded. Erase in the ERA mode the message assigned to a message number for which a new message is to be recorded.</p>
	<p>An attempt has been made to record a message under the message number to which a message has already been recorded (this error indication occurs when the ST/SP switch is pressed).</p>	<p>Specify a message number for which no message has been recorded and press the ST/SP switch. Or erase (in the ERA mode) the message number for which a message has been already recorded.</p>















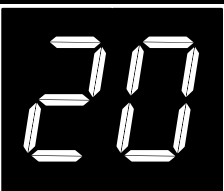

Note  : lit,  : blinking at 0.5 s intervals,  : blinking at 0.2 s intervals
 : blinking at high speed





Errors in ON-LINE mode

Display	Possible Cause	Correction
<p>RUN </p> <p>PLAY </p> <p>REC </p> <p>ERR </p> <p>OVF </p> 	<p>No message is recorded.</p>	<p>Check that the message is being recorded in REC mode or written in RCV mode.</p>
<p>The RUN and ERR indicators are lit. The other indicators are unlit.</p>	<p>The message memory has failed.</p>	<p>Either erase erroneous messages in ERA mode, or rewrite correct messages in RCV mode.</p>











Note  : lit,  : blinking at 0.5 s intervals,  : blinking at 0.2 s intervals
 : blinking at high speed



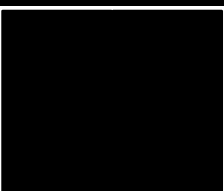

Errors in PLAY mode

Display	Possible Cause	Correction
<p>RUN </p> <p>PLAY </p> <p>REC </p> <p>ERR </p> <p>OVF </p>  <p>The RUN and ERR indicators are lit. The PLAY indicator is blinking at 0.5 second intervals. The 7-segment LEDs display a message number.</p>	<p>No message is recorded (in this situation the error indication is made when the mode selector switch is operated).</p>	<p>Check that the message is being recorded in REC mode, or written in RCV mode.</p>
<p>RUN </p> <p>PLAY </p> <p>REC </p> <p>ERR </p> <p>OVF </p>  <p>The RUN and ERR indicators are lit. The other indicators are unlit.</p>	<p>An attempt has been made to reproduce a message which is not recorded (in this situation the error indication is made when the SP/ST switch is pressed).</p>	<p>Specify a message which has been already recorded and press the ST/SP switch. Or record a message to the displayed message number while in REC mode.</p>
<p>RUN </p> <p>PLAY </p> <p>REC </p> <p>ERR </p> <p>OVF </p>  <p>The RUN and ERR indicators are lit. The other indicators are unlit.</p>	<p>The message memory has failed.</p>	<p>Either erase the erroneous message in ERA mode or rewrite a message in RCV mode.</p>

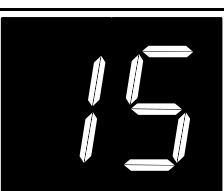
Note  : lit,  : blinking at 0.5 s intervals,  : blinking at 0.2 s intervals
 : blinking at high speed





Errors in T mode



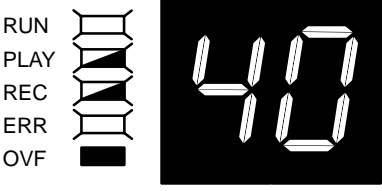
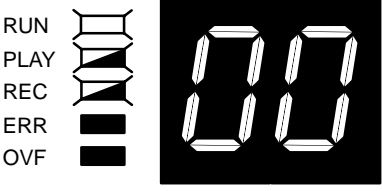
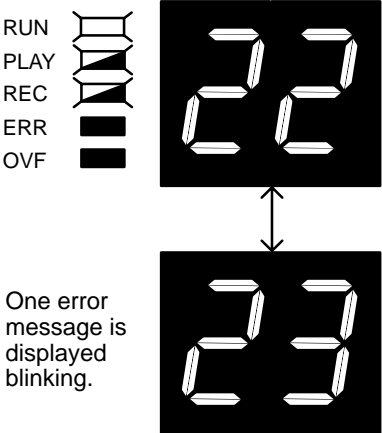
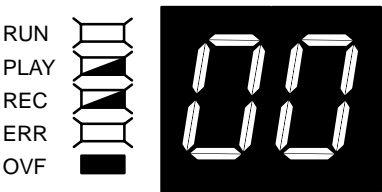

Display	Possible Cause	Correction
<p>RUN </p> <p>PLAY </p> <p>REC </p> <p>ERR </p> <p>OVF </p>  <p>The RUN and ERR indicators are lit. The other indicators are unlit.</p>	<p>An error has occurred in the message memory.</p>	<p>Erase the erroneous message in the ERA mode, or write a message in the RCV mode.</p>
<p>RUN </p> <p>PLAY </p> <p>REC </p> <p>ERR </p> <p>OVF </p>  <p>The RUN and ERR indicators are lit. The LEDs display the remaining recording time.</p>	<p>The memory protect switch is ON.</p>	<p>The remaining recording time can be checked even when the ERR indicator is lit.</p>

Note  : lit,  : blinking at 0.5 s intervals,  : blinking at 0.2 s intervals
 : blinking at high speed

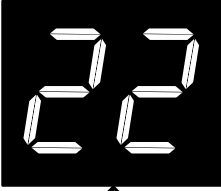
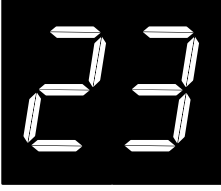









Errors in ERA mode



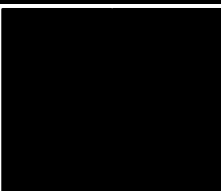

Display	Possible Cause	Correction
 <p>The RUN and ERR indicators are lit. The PLAY and REC indicators are blinking at 0.5 second intervals. The LEDs display a message number.</p>	<p>The memory protect switch is ON (in this situation the error indication is made when the mode selector switch is operated or when the ST/SP switch is pressed).</p>	<p>Turn OFF the memory protect switch and press the ST/SP switch.</p>
 <p>(Blinking)</p> <p>The RUN indicator are lit. The PLAY and REC indicators are blinking at 0.5 second intervals. The 7-segment LEDs display "00" at 0.5 second intervals.</p>	<p>Error in message memory (1) (The error indication is made when the mode selector switch is operated). In this case, data in the message memory is for some reason defective.</p>	<p>In this situation the only solution is to erase the entire memory. Press the ST/SP switch to erase all the memory contents.</p>
 <p>One error message is displayed blinking.</p> <p>The RUN indicator is lit. The PLAY and REC indicators are blinking at 0.5 second intervals. The LEDs display one or alternately two message numbers responsible for the error.</p>	<p>Error in message memory (2) (Error results in one or two messages because of a power failure that occurs while messages are erased or recorded.) This error occurs when a power failure occurs or when the PC is reset while messages are erased or recorded.</p>	<p>In this situation the solution is to erase the message responsible for the error. Press the ST/SP switch to clear the error code displayed on the LED display.</p>
 <p>(Blinking)</p> <p>The RUN and ERR indicators are lit. The PLAY and REC indicators are blinking at 0.5 second intervals. The 7-segment LEDs display "00" blinking at 0.5 second intervals.</p>	<p>A message memory error (1) occurs with the memory protect switch ON (in this situation the error indication is made when the mode selector switch is operated or when the ST/SP switch is pressed).</p>	<p>Turn OFF the memory protect switch and press the ST/SP switch to erase the entire contents of the message memory.</p>

Display	Possible Cause	Correction
<p>RUN </p> <p>PLAY </p> <p>REC </p> <p>ERR </p> <p>OVF </p>  <p>If there is only one error, the error code is displayed blinking.</p>  <p>The RUN and ERR indicators are lit. The PLAY and REC indicators are blinking at 0.5 second intervals. The LEDs display alternately up to two message numbers responsible for errors.</p>	<p>A message memory error (2) occurs with the memory protect switch ON (in this situation the error indication is made when the mode selector switch is operated or when the ST/SP switch is pressed).</p>	<p>Turn OFF the memory protect switch and press the ST/SP switch to clear the error code(s) displayed on the LED display.</p>

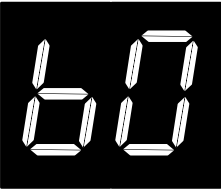



Note  : lit,  : blinking at 0.5 s intervals,  : blinking at 0.2 s intervals
 : blinking at high speed





Errors in XMT mode

Display	Possible Cause	Correction
<p>RUN </p> <p>PLAY </p> <p>REC </p> <p>ERR </p> <p>OVF </p>  <p>The RUN and ERR indicators are lit. The other indicators are unlit.</p>	<p>An error occurs in the message memory.</p>	<p>Either erase the erroneous message in ERA mode or rewrite the message in the RCV mode.</p>
<p>RUN </p> <p>PLAY </p> <p>REC </p> <p>ERR </p> <p>OVF </p>  <p>The RUN and ERR indicators are lit. The PLAY indicator is blinking at 0.2 second intervals. The 7-segment LEDs display a communication mode.</p>	<p>The RS-232C cable is disconnected or severed (in this situation the error indication is made when the ST/SP switch is pressed or while PC to Voice Unit communication is being executed).</p>	<p>Correctly connect the RS-232C cable and begin communication procedures from the start.</p>
	<p>An external device has sent data to the Voice Unit.</p>	<p>Get the external device ready for reception and begin communication procedures from the start.</p>

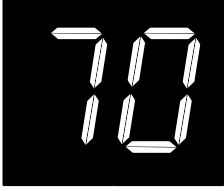
Note  : lit,  : blinking at 0.5 s intervals,  : blinking at 0.2 s intervals
 : blinking at high speed

Errors in RCV mode

Display	Possible Cause	Correction
<p>RUN </p> <p>PLAY </p> <p>REC </p> <p>ERR </p> <p>OVF </p> 	<p>The memory protect switch is ON (in this situation the error indication is made when the mode selector switch is operated or when the ST/SP switch is pressed).</p>	<p>Turn OFF the memory protect switch and start reception.</p>
<p>The RUN and ERR indicators are lit. The REC indicator is blinking at 0.2 second intervals. The LEDs display a communication mode.</p>	<p>The ST/SP switch was pressed while data was being received.</p>	<p>Begin the data reception procedure from the beginning.</p>
	<p>An error occurs in the data received.</p>	<p>Remove the cause of the error and begin the data reception procedure from the beginning</p>

Note  : lit,  : blinking at 0.5 s intervals,  : blinking at 0.2 s intervals
 : blinking at high speed

5-2 Troubleshooting

Recording

Error	Possible Cause	Correction
Message cannot be recorded	The message input jack is not connected correctly.	Check the connection of the plug connected to the message input jack.
	The microphone switch is OFF.	Turn ON the switch.
	The volume control of the tape recorder is at the MIN. position.	Adjust the volume control.
	The input volume control of the Voice Unit is at the MIN. position.	Turn the input volume control clockwise toward the MAX. position and adjust the volume.
	Pin 4 of the DIP switch on the back panel of the Voice Unit is ON.	Turn OFF the power to the PC, remove the Unit, and turn OFF pin 4 of the DIP switch.
	The line/microphone selector switch is set to the wrong position.	Check the setting of the line/microphone selector switch.
	The Voice Unit is defective.	Replace the Unit.
Message cannot be recorded (The ERR indicator is lit)	Refer to the error code.	Refer to the error code.
Message cannot be recorded (All indicators are unlit)	Refer to the error code.	Refer to the error code.
The sound of the message is distorted.	The message input level is too high.	Adjust the input volume control. When using a tape recorder, also adjust the volume control of the tape recorder.
The volume of the message is low even when the input volume control is turned to the maximum position.	The impedance of the microphone does not match that of the Voice Unit.	Check the impedance of the microphone.
	The impedance or output level of the tape recorder do not match those of the Voice Unit.	Check the impedance and maximum level of the tape recorder.

Playback

Error	Possible Cause	Correction
A Message is not played back	The output volume control is at the MIN. position (when a speaker is used).	Adjust the volume by turning the output volume control clockwise toward the MAX. position.
	Pin 4 of the DIP switches on the back panel of the Voice Unit is ON.	Turn OFF the power to the PC, remove the Unit, and turn OFF pin 4 of the DIP switches.
	The Voice Unit is defective.	Replace the Unit.
A Message is not played back (In on-line mode)	Incorrect output mode and operation mode have been selected on the DIP switch on the back panel.	Correctly set the DIP switch.
	The program is wrong.	Check the program.
A Message is not played back (The Error indicator is lit)	Refer to the error code.	Refer to the error code.
A Message is not played back (All indicators are unlit)	Refer to the error code	Refer to the error code.
A message is not issued from the external speaker connected.	The output jack is not correctly connected.	Check the connection of the plug connected to the output jack.
	The setting of the line/speaker selector switch is wrong.	Check the setting of the line/speaker selector switch.
	The impedance of the speaker/external amplifier does not match that of the Voice Unit.	Check the impedance of the speaker/external amplifier.
	The power to the external amplifier is OFF (when a speaker is connected through the external amplifier).	Turn ON the power to the external amplifier and adjust the volume.
The sound of the played back message is too high or too low.	The recording time when the message is played back is different from that when the message was recorded.	Set the recording time to the same as that when the message was recorded with the DIP switch.
The sound of the played back message is distorted.	The level of the message was too high when the message was recorded.	Record the message at the correct level.
	The output level is too high.	Adjust the level by operating the output volume control of the Unit and the volume control of the external amplifier.
A message not programmed is played back.	The program is wrong.	Check the program.
Noise is imposed on the played back message. Sometimes the message is not played back.	The played back message is affected by noise.	Separate the cables of the speaker from power lines and I/O lines.

Appendix A

Inspection and Maintenance

Inspection Items

Periodically inspect the following items:

Item	Particulars	Normal Operating Criteria	Remarks
Environmental conditions	Is the ambient operating temperature (temperature inside the control box) appropriate?	0°to 55°C	Thermometer
	Is ambient operating humidity (humidity inside the control box) appropriate?	35 to 85% (without condensation)	Hygrometer
	Has dust collected on the Unit?	The Unit must be free of dust.	Visual inspection
Mounting conditions	Is the Unit securely mounted?	The Unit must not be loose.	Periodic inspection
	Are the plugs inserted completely?	The plugs must be inserted completely.	Periodic inspection
	Are the cables intact?	The appearance must be normal.	Visual inspection

Have at least one spare Unit on hand for quick recovery in case of a failure.

Consumable Parts

Battery set: Model C200H-BAT09

The life of the battery is 5 years at 25°C. If the battery is used at a higher temperature, its life is shortened.

Assignment of the battery error flag differs depending on the message output mode, as follows, where n = 100 + 10 x unit no:

In sentence mode: word n+5 bit 05

In phrase combination mode: word n+9 bit 05

When the ERR indicator is lit due to a low battery, replace the battery with a new one within 1 week.

Replacing the Battery

- 1, 2, 3... 1. Turn OFF the power. When the power is OFF originally, turn the power ON to supply power to the Unit for at least 1 minute and then turn the power OFF.
2. Remove the protective cover on the battery compartment of the Voice Unit by pushing it downward (see Fig. 1).
3. Pull out the battery with the connector, and replace the battery. Complete this procedure within 5 minutes (see Fig. 2).
4. When mounting the new battery in the compartment, make sure that the cable of the battery fits correctly in the compartment.
5. Attach the protective cover by pushing it up, until the cover catch clicks into the hole above the compartment (see Fig. 2).

Note

Do not short-circuit the positive and negative poles of the battery or throw a used battery into a fire: doing so may cause the internal liquid of the battery to leak out, or the battery to catch fire or even explode.

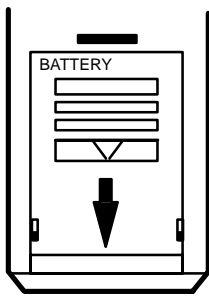

(Fig. 1)
Push the cover down.

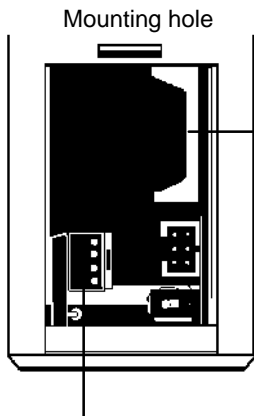
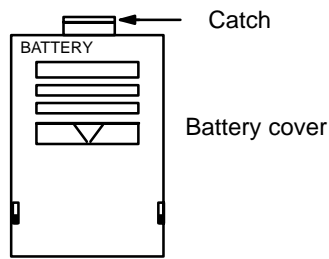

(Fig. 2)
Battery holder



Battery set C200H-BAT09

Notes on Handling

When replacing the Unit, be sure to turn OFF the power first.

After replacing the old Unit with a new one, check again to ensure the new Unit is normal.

When returning the Voice Unit for repairs, enclose with the faulty Unit a description of its problems or malfunctions.

When the Voice Unit malfunctions, the messages stored in its memory may be destroyed; it is therefore recommended that the messages be transferred to an external device for preservation. For how to transfer the messages, refer to *3-7 XMT/RCV Mode*.

Appendix B Specifications

Item		Specifications
Voice synthesis method		Adaptive Differential Pulse-Coded Modulation (ADPCM)
Message recording time		32/48/64 seconds (switch selectable)
Message capacity (sentences and phrases)		60 max.
Message input (switch-selectable)	MIC IN	Microphone input: unbalanced dynamic microphone (600 Ω)
	LINE IN	Tape input: Input impedance: 50 k Ω , unbalanced; Maximum input voltage: 3.3 V
Message output (switch-selectable)	SPEAKER OUT	Built-in amplifier output: 0.14 W (8 Ω speaker)
	LINE OUT	External amplifier output: 600 Ω unbalanced transformer output Maximum output voltage: 0.5 V rms (effective value) Both balanced and unbalanced external amplifiers can be connected.
Built-in monitor speaker		Diameter 27 mm, 0.1 W (8 Ω)
Input frequency		32-second recordings: 8 kHz 48-second recordings: 5.3 kHz 64-second recordings: 4 kHz
Output frequency characteristics		32-second recordings: 100 Hz to 3.2 kHz 48/64-second recordings: 100 Hz to 2.2 kHz
Lowpass filter selector function (see below)		Cutoff frequency: 3.2 kHz for 32-second recordings, 2.2 kHz for 48/64-second recordings
Message memory		128K bytes RAM (battery powered)
External communication function (for saving recorded messages)		RS-232C (Baud rate: 19,200/9,600/4,800/2,400 bps. XON/XOFF: yes/no, CTS/RTS: yes/no)
Self-diagnosis function		CPU watchdog timer, LOW battery voltage detection
Battery life		5 years at 25°C (battery life is shorter for higher temperatures)
Internal current consumption		300 mA 5 VDC max.
Dimensions (mm)		35 (Width) x 130 (Height) x 100.5 (Depth)
Weight		400 g max.

LPF (lowpass filter) function

The recording time of the Voice Unit is varied by changing the unit's input frequency. For improved sound quality, the cutoff frequency of the lowpass filter is automatically changed to a lower frequency when the recording time is increased from 32 to either 48 or 64 seconds. (The output frequency is set to 100 Hz to 2.2 kHz when the recording time is set to 48 or 64 seconds.)

Dimensions

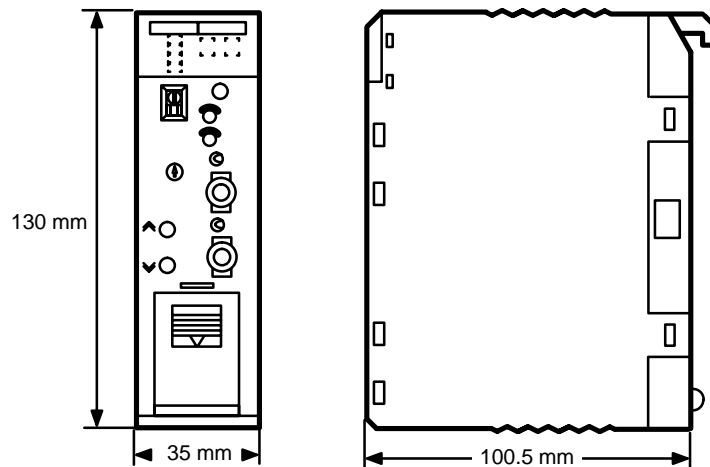

When mounted to a Rack

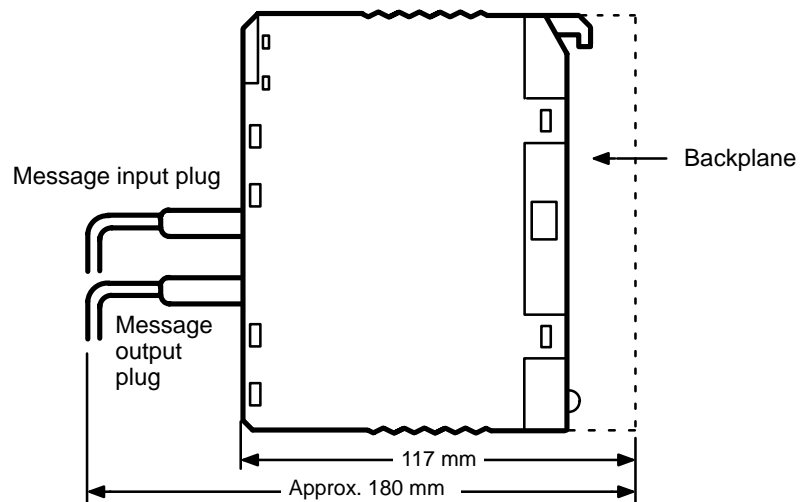

The depth of the Voice Unit itself measures 100.5 mm. However, when the Unit is mounted on a Backplane and when connectors are connected to the Unit, the total depth increases to about 180 mm. Take this into account when installing a mounted Unit in a control box.

Please complete the assembly of the accessory cables, connectors, and plugs supplied.

Appendix C Standard Models

Name	Description	Model
Voice Unit	RAM	C200H-OV001
Battery set	Backup battery for C200H	C200H-BAT09
RS-232C cable	6-to-25-pin conversion Cable length: 2 m For C200H Voice Unit	C200H-CN224

Glossary

Rack-Mounting Host Link Unit	A Host Link Unit that mounts onto a Rack, and not directly to the CPU.
baud rate	Transfer speed between two devices in a system measured in bits per second. For example, an optical sensor might be configured to send its information to the FIT at 9600 baud. It is important for both of the devices to be set to the same baud rate.
bit	The smallest piece of information that can be represented on a computer. A bit has the value of either zero or one, corresponding to the electrical signals ON and OFF. A bit is one binary digit.
CPU Rack	Part of a Rack PC, the CPU Rack contains the CPU, a Power Supply, and other Units.
Cutoff frequency	The maximum frequency that can pass through a lowpass filter; frequency components higher than the cutoff frequency are blocked.
data area	An area in the PC's memory that is designed to hold a specific type of data, e.g., the LR area is designed to hold common data in a PC Link System.
Expansion I/O Rack	Part of a Rack PC, an Expansion I/O Rack is connected to a CPU Rack to increase the number of slots available for mounting Units.
flag	A bit that is turned ON and OFF automatically by the system in order to provide status information.
Lowpass filter	Lowpass filters block the high-frequency components contained in voice signals.
PC	An acronym for Programmable Controller.
PROM Writer	A PROM Writer is a device used to write data to ROM, PROM, and EPROM storage chips.
RAM	[R(andom) A(ccess) M(emory)] RAM will not retain data when power is disconnected. Therefore data should not be stored in RAM
RS-232 interface	An industry standard connector for serial communications.
scan time	The total time it takes the PC to perform internal operations, i.e., reset the watchdog timer, read the program, receive input data, send output data, and execute instructions. Scan time is monitored by the watchdog timer within the PC, and if it takes longer than a certain specified amount of time, an error message may be generated, or the CPU may just stop. Scan times will differ depending on the configuration of the system.
Unit	In OMRON PC terminology, the word Unit is capitalized to indicate any product sold for a PC System. though most of the names of these products end with the word Unit, not all do, e.g., a Remote Terminal is referred to in a col-

lective sense as a Unit. Context generally makes any limitations of this word clear.

word

In digital circuits, a group of bits. Usually a word consists of four, eight, or sixteen bits. In C-series PCs, a word consists of sixteen bits. Words can be used to store data, or they can be used for I/O.

Index

Symbols

Empty, 69

A

applications, precautions, ix

B

Back Panel, 6
Balanced Amplifier Connection, 10
Balanced to Unbalanced Plug Conversion, 9
Battery Installation and Removal, 3
Bit Number Allocation, 14

C

C200HX/HG/HE(-Z) PCs, 8
Connecting Output Devices, 25
Connection Advantages and Instructions, 8 , 9
Connection to the CPU Rack and Expansion I/O Rack, 7
Connector Pin No. and Signal Name, 10
Connector Pin Nol and Signal Name, 10
CS1-series PCs, 8

D

Data Areas, 14
Dimensions, 90
DIP Switch settings, 6
Display Indication during Message Playback, 39

E

Erasing Recorded Messages, 27
Error Codes, 80

F

Front Panel, 2

I

Input Device Connection, 23
Input message source, 5
Input/Output Device Connection, 8
installation, precautions, ix
IR Bit Allocation, 14

J

Jack and Plug Mismatches, 9

L

LEDs and Indicators, 4
Limits on Remote I/O Slave Rack Mounting, 8
LPF (Lowpass filter) Selection Function, 89

M

Maintenance and Inspection, 87
Memory Protect Switch, 3 , 20
Message Data Transfer/Reception Time, 37 , 38
Message Erasing Time, 31
Message Input Jack Connection, 8
Message Output Jack Connection, 9
Message Output Mode Types, 56
Microphone Recordings, 9
Mixing Function, 57
Mixing Switch, 6

O

operating environment, precautions, ix
Operating Procedure, 21
Output message device, 5

P

PC Data Transfer, 45
Phrase Combination Mode, 16
Phrase Combination Mode Example Programs, 65
Plug Size Conversion, 9
precautions, vii
 applications, ix
 general, viii
 operating environment, ix
 safety, viii
Preliminary DIP Switch Setting, 20

R

Recording Messages, 22
Recording Procedure, 22
Remaining Recording Time, 32
Replacing Battery, 87
RS-232C Cable Connector Pin Specifications, 11

S

safety precautions. *See* precautions
Sentence Mode, 15
Sentence Mode Example Programs, 60
Speaker Connection, 9
Specifications, 89

Index

Standard Models, 91
Switches, Controls, and Jacks, 5
system Configuration, 7

T

Tape Recorder Recordings, 9
Timing Diagrams, 40

U

Unbalanced Amplifier Connection, 10

Unit No. Setting Switch, 20

V

Voice Unit Operation via the Program, 38

W

Wiring, 10



Artisan Technology Group is your source for quality new and certified-used/pre-owned equipment

- FAST SHIPPING AND DELIVERY
- TENS OF THOUSANDS OF IN-STOCK ITEMS
- EQUIPMENT DEMOS
- HUNDREDS OF MANUFACTURERS SUPPORTED
- LEASING/MONTHLY RENTALS
- ITAR CERTIFIED SECURE ASSET SOLUTIONS

SERVICE CENTER REPAIRS

Experienced engineers and technicians on staff at our full-service, in-house repair center

*InstraView*SM REMOTE INSPECTION

Remotely inspect equipment before purchasing with our interactive website at www.instraview.com ↗

WE BUY USED EQUIPMENT

Sell your excess, underutilized, and idle used equipment. We also offer credit for buy-backs and trade-ins. www.artisanng.com/WeBuyEquipment ↗

LOOKING FOR MORE INFORMATION?

Visit us on the web at www.artisanng.com ↗ for more information on price quotations, drivers, technical specifications, manuals, and documentation

Contact us: (888) 88-SOURCE | sales@artisanng.com | www.artisanng.com