



Artisan Scientific

QUALITY INSTRUMENTATION ... GUARANTEED

Looking for more information?

Visit us on the web at <http://www.artisan-scientific.com> for more information:

- Price Quotations
- Drivers
- Technical Specifications, Manuals and Documentation

Artisan Scientific is Your Source for Quality New and Certified-Used/Pre-owned Equipment

- Tens of Thousands of In-Stock Items
- Hundreds of Manufacturers Supported
- Fast Shipping and Delivery
- Leasing / Monthly Rentals
- Equipment Demos
- Consignment

Service Center Repairs

Experienced Engineers and Technicians on staff in our State-of-the-art Full-Service In-House Service Center Facility

InstraView™ Remote Inspection

Remotely inspect equipment before purchasing with our Innovative InstraView™ website at <http://www.instraview.com>

We buy used equipment! We also offer credit for Buy-Backs and Trade-Ins

Sell your excess, underutilized, and idle used equipment. Contact one of our Customer Service Representatives today!

Talk to a live person: 888-88-SOURCE (888-887-6872) | Contact us by email: sales@artisan-scientific.com | Visit our website: <http://www.artisan-scientific.com>

| | |
|----------|-------|
| SECTION | 2A |
| PAGE | 28 |
| ISSUED | 2/03 |
| REPLACES | 12/01 |

SERIES: GA7-1-1/4
GA6-1-1/2
GA6-2
GA7-1-1/2



CLOSED COUPLED CENTRIFUGAL PUMPS

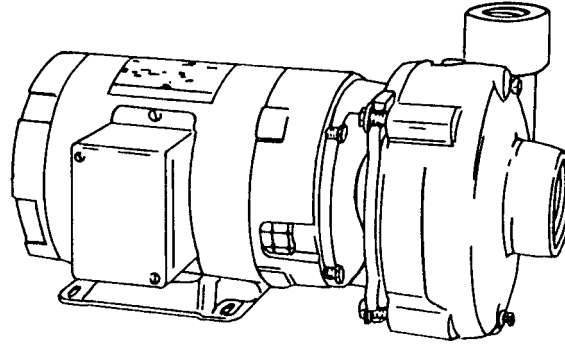

3500RPM - 60Hz.
 CAPACITIES TO 300GPM (19LPS)
 HEADS TO 230 FEET (70M)

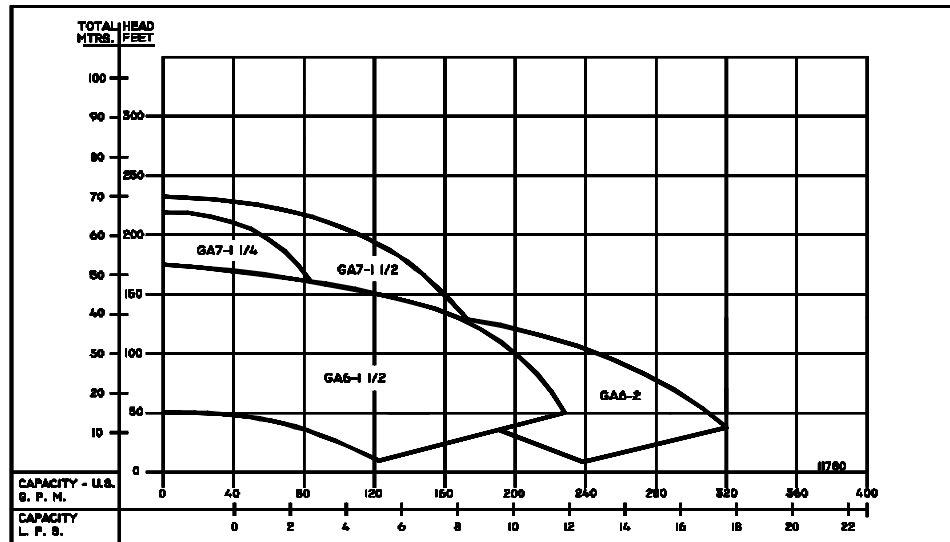

2900RPM - 50Hz.
 CAPACITIES TO 280GPM (18LPS)
 HEADS TO 152 FEET (46.3M)

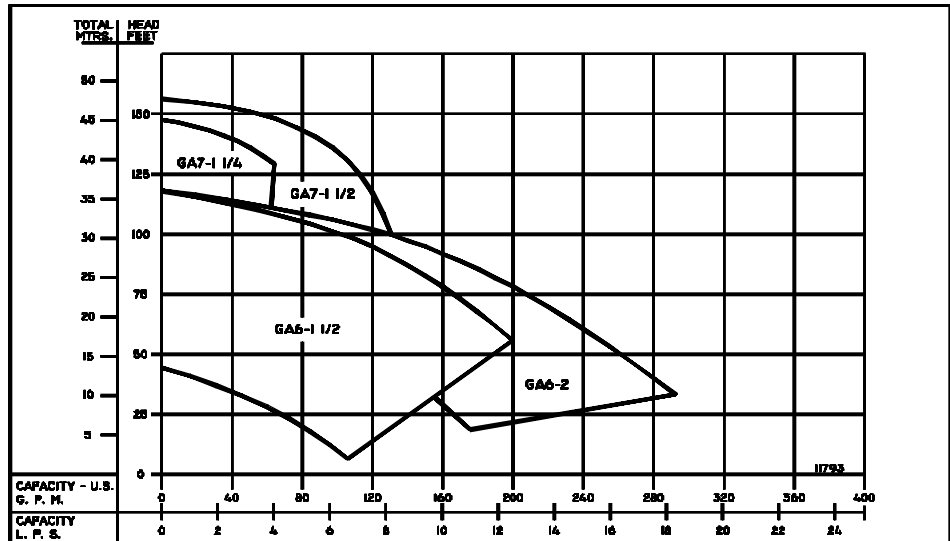

PUMPS & SYSTEMS

A Crane Co. Company

FEATURES

- **FOUR POSITION CASING**

Discharge can be located in any of four positions. Casing is close grain iron of 30,000 psi minimum tensile strength. Back pull-out design eliminates the need to disturb piping should the pump ever require service - the casing stays in the line.

- **ENCLOSED BRONZE IMPELLER**

Of the latest hydraulic design for maximum efficiency, impeller is balanced for vibration-free operation. It is precision fit to shaft with key drive and cap screw lock.

- **MECHANICAL SHAFT SEAL**

Standard self-adjusting shaft seal for temperatures to 225°F (107°C) and pressures to 150 psi (1034kpa). Ceramic seat and carbon seal face for long trouble-free service. Special seals are available for higher temperatures and fluids other than water.

- **BRONZE SHAFT SLEEVE**

Gasketed and keyed hook-type sleeve protects shaft from wear and corrosion in seal area.

- **MOTORS**

JM Type motors have NEMA standard mounting flange, extended steel shaft and dual bearings. These motors offer the advantages of quiet operation, controlled shaft deflection for longer seal life, and bearings sized to provide good service life. All motors are supplied by manufacturers with national field service facilities.

- **FACTORY TESTED**

After careful assembly and inspection, **EVERY** pump is factory tested and will meet Hydraulic Institute standards.

| MAXIMUM OPERATING CONDITIONS | |
|---|-------------------|
| TEMPERATURE (For Standard Buna-N Seal) | 225°F (107°C) |
| INLET PRESSURE | 100 PSI (690kpa) |
| CASING WORKING PRESSURE | 200 PSI (1379kpa) |

MOTOR INFORMATION

60 Hz - 1750 RPM - ODP

60 Hz - 3500 RPM - ODP

Single Phase: 1 thru 2 Hp. - 115/230 V
3 & 7 1/2 Hp. - 230 V.

Three Phase: 1 thru 10 Hp. - 230/460 V

50 Hz - 2900 RPM - ODP

50 Hz - 1450 RPM - ODP

Single Phase: 110/220 Volt

Three Phase: 380 Volt

Voltages may differ from some suppliers. Consult factory.
Overload Protection: All motors must be installed with magnetic starter which provides full overload protection on all legs. Failure to use correct starter and overloads will void motor warranty.

GA6 Series pumps are not available with 7-1/2 HP Totally Enclosed or Explosion Proof motors.

MATERIALS OF CONSTRUCTION

| PART | BRONZE FITTED | ALL BRONZE | ◇ ALL IRON |
|--------------|-----------------------------------|-----------------------------------|-----------------------------------|
| Adapter | Cast Iron | Bronze | Cast Iron |
| Casing | Cast Iron | Bronze | Cast Iron |
| Shaft | Steel | Steel | Steel |
| Impeller | Bronze | Bronze | Cast Iron |
| Shaft Sleeve | Bronze | Bronze | #316 Stainless |
| Shaft Seal | Carbon-Ceramic S. Steel-Buna-N | Carbon-Ceramic S. Steel-Buna-N | Carbon-Ceramic S. Steel-Buna-N |

◇ Does NOT include GA7-1 1/2

| | |
|----------|-------|
| SECTION | 2A |
| PAGE | 30 |
| ISSUED | 2/03 |
| REPLACES | 12/01 |



DIMENSIONS

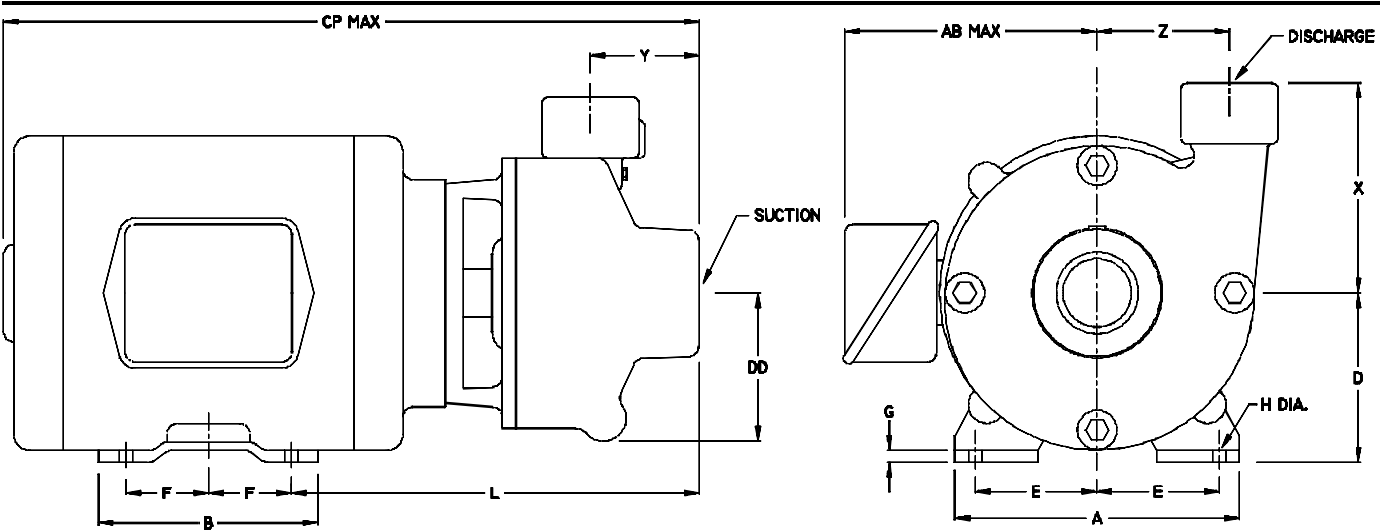

| Catalog Number | | HP | Motor Frame Size | Disc. NPT | Suct. NPT | DIMENSIONS IN INCHES | | | | | | | | | | | | | |
|--------------------------------------|---------------------------------------|-------------------------------|------------------|--------------------------------|---------------------------------|-------------------------------|---------------------------------|-------------------------------|----------------------------------|--------------------------------|--------------------------------|-------------------------------|----------------------------------|----------------------------------|----------------------------------|----------------------------------|----------------------------------|---------------------------------|---------------------------------|
| 1 Phase | 3 Phase | | | | | A | AB | B | CP | D | DD | E | F | G | H | L | X | Y | Z |
| 30GA7-1 ¹ / ₄ | 330GA7-1 ¹ / ₄ | 3 | 145JM | 1 ¹ / ₄ | 1 ¹ / ₂ | 7 | 8 ¹⁵ / ₁₆ | 6 | 17 ⁷ / ₁₆ | 3 ¹ / ₂ | 4 ¹ / ₂ | 2 ³ / ₄ | 2 ¹ / ₂ | 3 ³ / ₈ | 11 ¹¹ / ₃₂ | 10 ¹ / ₄ | 5 ⁵ / ₈ | 3 ⁵ / ₁₆ | 4 ¹ / ₁₆ |
| 50GA7-1 ¹ / ₄ | 350GA7-1 ¹ / ₄ | 5 | 182JM | | | 8 ³ / ₄ | 9 ⁷ / ₈ | 5 ³ / ₄ | 18 ³ / ₁₆ | 4 ¹ / ₂ | 4 ¹ / ₂ | 3 ³ / ₄ | 2 ¹ / ₄ | 1 ¹ / ₂ | 13 ¹³ / ₃₂ | 11 | 5 ⁵ / ₈ | 3 ⁵ / ₁₆ | 4 ¹ / ₁₆ |
| ----- | 375GA7-1 ¹ / ₄ | 7 ¹ / ₂ | 184JM | | | 8 ³ / ₄ | 9 ⁷ / ₈ | 6 ³ / ₄ | 19 ³ / ₁₆ | 4 ¹ / ₂ | 4 ¹ / ₂ | 3 ³ / ₄ | 2 ³ / ₄ | 1 ¹ / ₂ | 13 ¹³ / ₃₂ | 11 | 5 ⁵ / ₈ | 3 ⁵ / ₁₆ | 4 ¹ / ₁₆ |
| 104GA6-1 ¹ / ₂ | 3104GA6-1 ¹ / ₂ | 1 | 143JM | 1 ¹ / ₂ | 2 | 7 | 8 ¹⁵ / ₁₆ | 5 | 15 ¹³ / ₁₆ | 4 ⁵ / ₁₆ | 3 ¹ / ₂ | 2 ³ / ₄ | 2 | 3 ³ / ₈ | 11 ¹¹ / ₃₂ | 9 ⁵ / ₈ | 4 ³ / ₄ | 2 ⁹ / ₁₆ | 3 ¹³ / ₁₆ |
| 15GA6-1 ¹ / ₂ | 315GA6-1 ¹ / ₂ | 1 ¹ / ₂ | 143JM | | | 7 | 8 ¹⁵ / ₁₆ | 5 | 15 ¹³ / ₁₆ | 4 ⁵ / ₁₆ | 3 ¹ / ₂ | 2 ³ / ₄ | 2 | 3 ³ / ₈ | 11 ¹¹ / ₃₂ | 9 ⁵ / ₈ | 4 ³ / ₄ | 2 ⁹ / ₁₆ | 3 ¹³ / ₁₆ |
| 20GA6-1 ¹ / ₂ | 320GA6-1 ¹ / ₂ | 2 | 145JM | | | 7 | 8 ¹⁵ / ₁₆ | 6 | 16 ¹³ / ₁₆ | 4 ⁵ / ₁₆ | 3 ¹ / ₂ | 2 ³ / ₄ | 2 ¹ / ₂ | 3 ³ / ₈ | 11 ¹¹ / ₃₂ | 9 ⁵ / ₈ | 4 ³ / ₄ | 2 ⁹ / ₁₆ | 3 ¹³ / ₁₆ |
| 30GA6-1 ¹ / ₂ | 330GA6-1 ¹ / ₂ | 3 | 145JM | | | 7 | 8 ¹⁵ / ₁₆ | 6 | 16 ¹³ / ₁₆ | 4 ⁵ / ₁₆ | 3 ¹ / ₂ | 2 ³ / ₄ | 2 ¹ / ₂ | 3 ³ / ₈ | 11 ¹¹ / ₃₂ | 9 ⁵ / ₈ | 4 ³ / ₄ | 2 ⁹ / ₁₆ | 3 ¹³ / ₁₆ |
| 50GA6-1 ¹ / ₂ | 350GA6-1 ¹ / ₂ | 5 | 182JM | | | 8 ³ / ₄ | 9 ⁷ / ₈ | 5 ³ / ₄ | 17 ⁹ / ₁₆ | 4 ⁵ / ₁₆ | 4 ¹ / ₂ | 3 ³ / ₄ | 2 ¹ / ₄ | 1 ¹ / ₂ | 13 ¹³ / ₃₂ | 10 ³ / ₈ | 4 ³ / ₄ | 2 ⁹ / ₁₆ | 3 ¹³ / ₁₆ |
| ----- | 375GA6-1 ¹ / ₂ | 7 ¹ / ₂ | 184JM | | | 8 ³ / ₄ | 9 ⁷ / ₈ | 6 ³ / ₄ | 18 ⁹ / ₁₆ | 4 ⁵ / ₁₆ | 4 ¹ / ₂ | 3 ³ / ₄ | 2 ³ / ₄ | 1 ¹ / ₂ | 13 ¹³ / ₃₂ | 10 ³ / ₈ | 4 ³ / ₄ | 2 ⁹ / ₁₆ | 3 ¹³ / ₁₆ |
| 104GA6-2 | 3104GA6-2 | 1 | 143JM | 2 | 2 ¹ / ₂ | 7 | 8 ¹⁵ / ₁₆ | 5 | 16 ¹ / ₁₆ | 4 ⁵ / ₈ | 3 ¹ / ₂ | 2 ³ / ₄ | 2 | 3 ³ / ₈ | 11 ¹¹ / ₃₂ | 9 ⁷ / ₈ | 5 ⁷ / ₁₆ | 2 ³ / ₄ | 4 |
| 154GA6-2 | 3154GA6-2 | 1 ¹ / ₂ | 145JM | | | 7 | 8 ¹⁵ / ₁₆ | 6 | 17 ¹ / ₁₆ | 4 ⁵ / ₈ | 3 ¹ / ₂ | 2 ³ / ₄ | 2 ¹ / ₂ | 3 ³ / ₈ | 11 ¹¹ / ₃₂ | 9 ⁷ / ₈ | 5 ⁷ / ₁₆ | 2 ³ / ₄ | 4 |
| 30GA6-2 | 330GA6-2 | 3 | 145JM | | | 7 | 8 ¹⁵ / ₁₆ | 6 | 17 ¹ / ₁₆ | 4 ⁵ / ₈ | 3 ¹ / ₂ | 2 ³ / ₄ | 2 ¹ / ₂ | 3 ³ / ₈ | 11 ¹¹ / ₃₂ | 9 ⁷ / ₈ | 5 ⁷ / ₁₆ | 2 ³ / ₄ | 4 |
| 50GA6-2 | 350GA6-2 | 5 | 182JM | 2 | 2 ¹ / ₂ | 8 ³ / ₄ | 9 ⁷ / ₈ | 5 ³ / ₄ | 17 ¹³ / ₁₆ | 4 ⁵ / ₈ | 4 ¹ / ₂ | 3 ³ / ₄ | 2 ¹ / ₄ | 1 ¹ / ₂ | 13 ¹³ / ₃₂ | 10 ⁵ / ₈ | 5 ⁷ / ₁₆ | 2 ³ / ₄ | 4 |
| ----- | 375GA6-2 | 7 ¹ / ₂ | 184JM | | | 8 ³ / ₄ | 9 ⁷ / ₈ | 6 ³ / ₄ | 18 ¹³ / ₁₆ | 4 ⁵ / ₈ | 4 ¹ / ₂ | 3 ³ / ₄ | 2 ³ / ₄ | 1 ¹ / ₂ | 13 ¹³ / ₃₂ | 10 ⁵ / ₈ | 5 ⁷ / ₁₆ | 2 ³ / ₄ | 4 |
| 104GA7-1 ¹ / ₂ | 3104GA7-1 ¹ / ₂ | 1 | 143JM | | | 1 ¹ / ₂ | 2 | 7 | 8 ¹⁵ / ₁₆ | 5 | 16 ¹ / ₂ | 3 ¹ / ₂ | 4 ⁹ / ₁₆ | 2 ³ / ₄ | 2 | 3 ³ / ₈ | 11 ¹¹ / ₃₂ | 10 ⁵ / ₁₆ | 6 |
| 154GA7-1 ¹ / ₂ | 3154GA7-1 ¹ / ₂ | 1 ¹ / ₂ | 145JM | 7 | 8 ¹⁵ / ₁₆ | | | 6 | 17 ¹ / ₂ | 3 ¹ / ₂ | 4 ⁹ / ₁₆ | 2 ³ / ₄ | 2 ¹ / ₂ | 3 ³ / ₈ | 11 ¹¹ / ₃₂ | 10 ⁵ / ₁₆ | 6 | 3 ⁵ / ₁₆ | 4 ¹ / ₄ |
| 50GA7-1 ¹ / ₂ | ----- | 5 | 184JM | 9 | 9 ⁷ / ₈ | | | 6 ³ / ₄ | 19 ¹ / ₄ | 4 ¹ / ₂ | 4 ⁹ / ₁₆ | 3 ³ / ₄ | 2 ³ / ₄ | 1 ¹ / ₂ | 13 ¹³ / ₃₂ | 11 ¹ / ₁₆ | 6 | 3 ⁵ / ₁₆ | 4 ¹ / ₄ |
| ----- | 350GA7-1 ¹ / ₂ | 5 | 182JM | 9 | 9 ⁷ / ₈ | | | 5 ³ / ₄ | 18 ¹ / ₄ | 4 ¹ / ₂ | 4 ⁹ / ₁₆ | 3 ³ / ₄ | 2 ¹ / ₄ | 1 ¹ / ₂ | 13 ¹³ / ₃₂ | 11 ¹ / ₁₆ | 6 | 3 ⁵ / ₁₆ | 4 ¹ / ₄ |
| 75GA7-1 ¹ / ₂ | ----- | 7 ¹ / ₂ | 213JM | 10 ¹ / ₂ | 11 ¹ / ₁₆ | | | 7 ¹ / ₄ | 20 ³ / ₄ | 5 ¹ / ₄ | 4 ⁹ / ₁₆ | 4 ¹ / ₄ | 2 ³ / ₄ | 5 ⁵ / ₈ | 13 ¹³ / ₃₂ | 11 ¹⁵ / ₁₆ | 6 | 3 ⁵ / ₁₆ | 4 ¹ / ₄ |
| ----- | 375GA7-1 ¹ / ₂ | 7 ¹ / ₂ | 184JM | 9 | 9 ⁷ / ₈ | | | 6 ³ / ₄ | 19 ¹ / ₄ | 4 ¹ / ₂ | 4 ⁹ / ₁₆ | 3 ³ / ₄ | 2 ³ / ₄ | 1 ¹ / ₂ | 13 ¹³ / ₃₂ | 11 ¹ / ₁₆ | 6 | 3 ⁵ / ₁₆ | 4 ¹ / ₄ |
| ----- | 3100GA7-1 ¹ / ₂ | 10 | 213JM | 10 ¹ / ₂ | 11 ¹ / ₁₆ | 7 ¹ / ₄ | 20 ³ / ₄ | 5 ¹ / ₄ | 4 ⁹ / ₁₆ | 4 ¹ / ₄ | 2 ³ / ₄ | 5 ⁵ / ₈ | 13 ¹³ / ₃₂ | 11 ¹⁵ / ₁₆ | 6 | 3 ⁵ / ₁₆ | 4 ¹ / ₄ | | |

DIMENSIONS SHOWN ABOVE ARE APPROXIMATE MAXIMUM DIMENSIONS FOR STANDARD PUMPS EQUIPPED WITH ODP MOTORS.



PUMPS & SYSTEMS

A Crane Co. Company

| | |
|----------|-------|
| SECTION | 2A |
| PAGE | 32 |
| ISSUED | 2/03 |
| REPLACES | 12/01 |

60HZ PERFORMANCE CURVE



END SUCTION CENTRIFUGAL PUMPS

3500
RPM

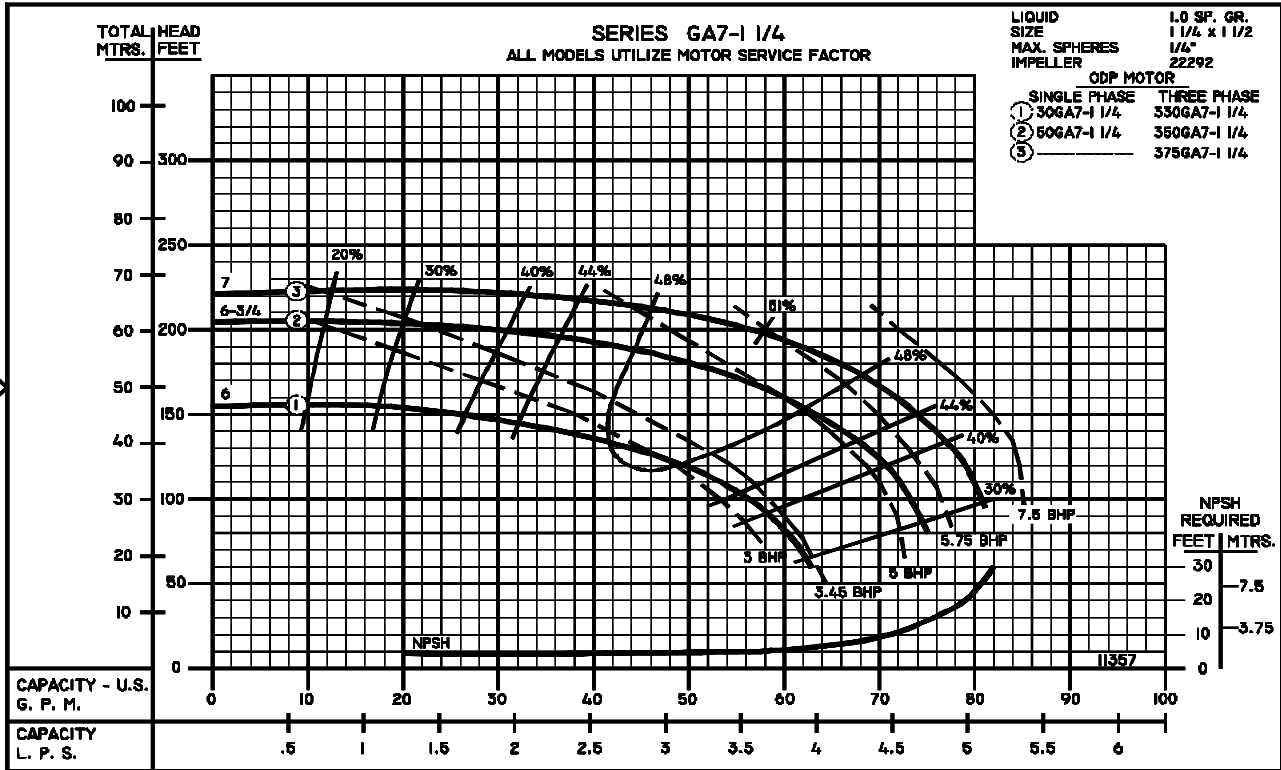

3500
RPM

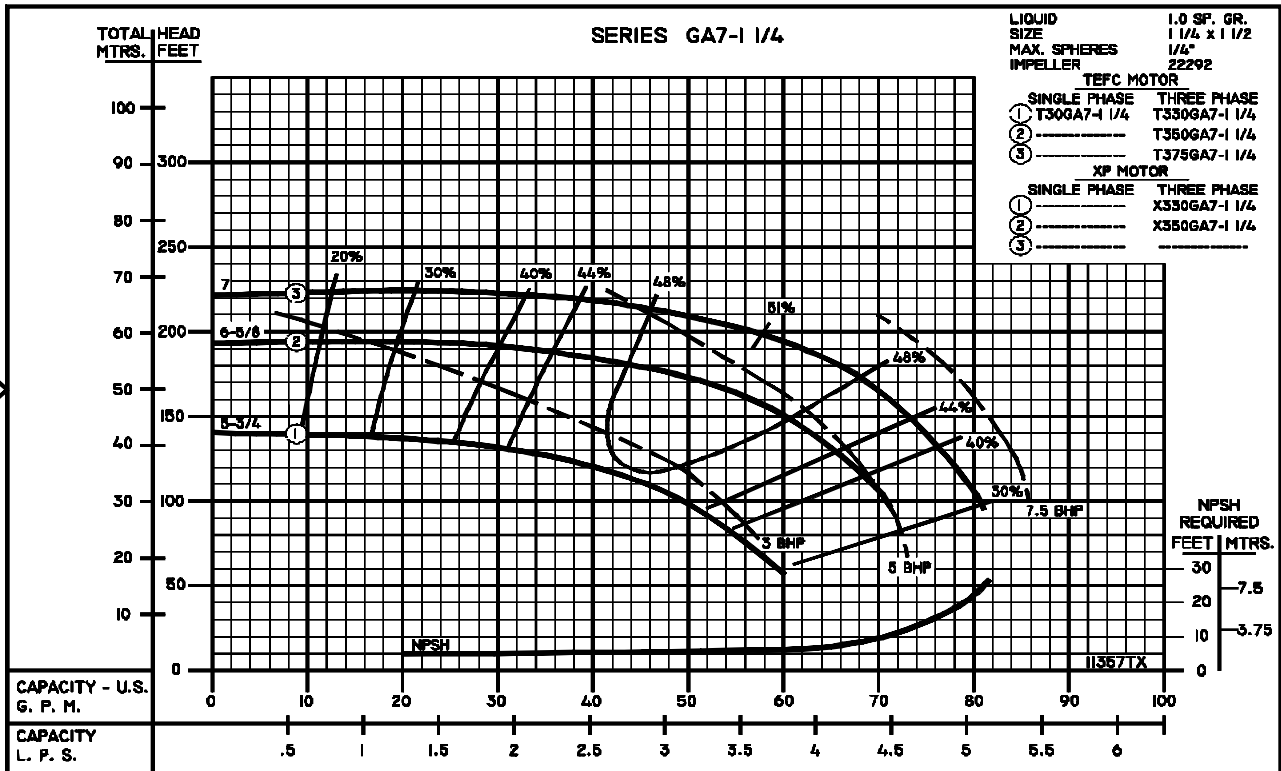

PUMPS & SYSTEMS

A Crane Co. Company

CCCP-8

| 1 - MOTORS | | | |
|------------------------------------|-------------|-----|------------|
| RPM & PHASE | PART NUMBER | HP | FRAME SIZE |
| OPEN DRIP PROOF | | | |
| 3500 RPM Single Phase (ODP) | 09901 | 3 | 182JM |
| | 09902 | 5 | 184JM |
| 3500 RPM Three Phase (ODP) | 09905 | 3 | 145JM |
| | 09906 | 5 | 182JM |
| | 09907 | 7.5 | 184JM |
| | 09999 | 10 | 213JM |
| TOTALLY ENCLOSED | | | |
| 3500 RPM Single Phase (TEFC) | 21881 | 3 | 182JM |
| | 23990B | 5 | 184JM |
| 3500 RPM Three Phase (TEFC) | 09947 | 3 | 182JM |
| | 09950 | 5 | 184JM |
| | 09951 | 7.5 | 213JM |
| EXPLOSION PROOF | | | |
| 3500 RPM Three Phase (XP) | 09953 | 3 | 182JM |
| | 09954 | 5 | 184JM |

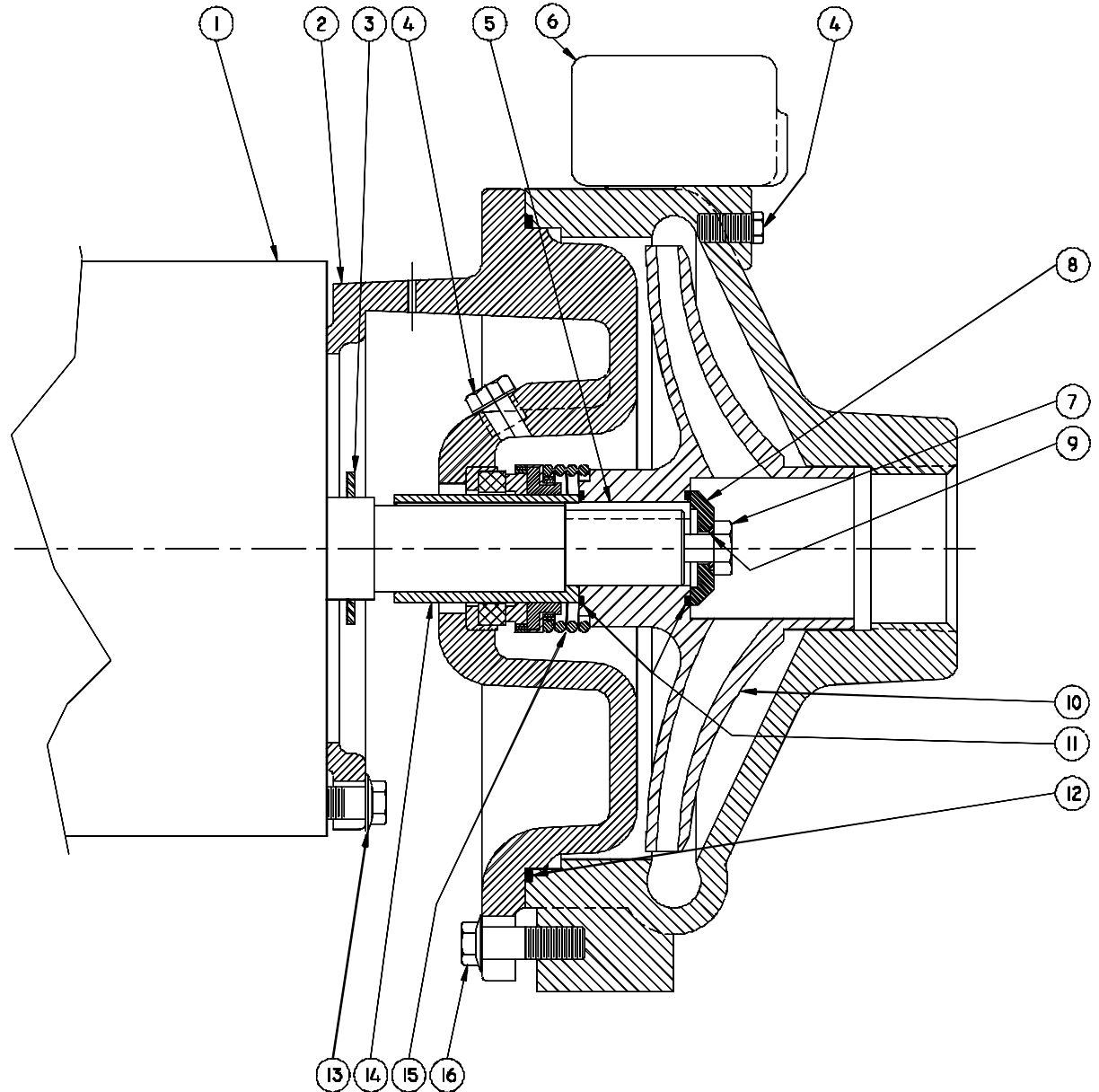

SERIES: GA7-1-1/4 CENTRIFUGAL PUMPS

File: GA7-125.dwg

| SYMBOL NUMBER | PART NUMBER | QUANTITY | DESCRIPTION |
|---------------|-------------|----------|-------------------------------------|
| 2 | 22294 | 1 | Adapter 180JM Frame |
| | 22845 | 1 | Adapter 213-215JM Frame |
| 3 | 09918 | 1 | Slinger Washer |
| 4 | 00158 | 2 | Pipe Plug - 1/8" Bronze |
| 5 | 23014 | 1 | Key |
| 6 | 22293 | 1 | Casing |
| 7 | 1-529-1 | 1 | Cap Screw-S.S. |
| 8 | 22105-C | 1 | Washer - Bronze |
| 9 | 22080 | 1 | O-Ring Gasket - Buna N (Std) |
| | 2-31005-012 | 1 | O-Ring Gasket - Viton |
| | 22093 | 1 | O-Ring Gasket - EPDM* |
| 10 | 22292-6.00 | 1 | Impeller-30GA7-1-1/4 & 330GA7-1-1/4 |
| | 22292-6.75 | 1 | Impeller-50GA7-1-1/4 & 350GA7-1-1/4 |
| | 22292-7.00 | 1 | Impeller-375GA7-1-1/4 |
| 11 | 22083 | 2 | O-Ring Gasket - Buna N (Std) |
| | 22084 | 2 | O-Ring Gasket - Viton |
| | 22094 | 2 | O-Ring Gasket - EPDM* |
| 12 | 22321 | 1 | O-Ring Gasket - Buna N (Std) |
| | 22322 | 1 | O-Ring Gasket - Viton |
| | 22324 | 1 | O-Ring Gasket - EPDM* |

| SYMBOL NUMBER | PART NUMBER | QUANTITY | DESCRIPTION |
|--|---------------|----------|--------------------------------|
| 13 | 21236 | 4 | Cap Screw |
| 14 | 22063-C | 1 | Shaft Sleeve - Bronze |
| 15 | 09917 | 1 | Mechanical Seal - Buna N (Std) |
| | 09926 | 1 | Mechanical Seal - Viton |
| | 21271 | 1 | Mechanical Seal - EPDM* |
| 16 | 22803 | 4 | Cap Screw |
| DIFFERING PARTS FOR ALL BRONZE CONSTRUCTION | | | |
| 2 | 22294-A | 1 | Adapter-Bronze |
| 4 | 01691-A | 2 | Pipe Plug, 1/8" - Bronze |
| 6 | 22293-A | 1 | Casing - Bronze |
| 7 | 03289 | 1 | Cap Screw - Bronze |
| DIFFERING PARTS FOR ALL IRON CONSTRUCTION | | | |
| 4 | 00158 | 2 | Pipe Plug - 1/8" Steel |
| 8 | 22105-A | 1 | Washer - Steel |
| 10 | Not Available | 1 | Impeller-Iron |
| 14 | 22063-A | 1 | Shaft Sleeve - S.S. |

* For hot water or caustic service.

CCCP-9

SERIES: GA7-1-1/4

For technical advice or service please take your pump into your local pump service center.
To order pump or parts or for pricing please go to the following links :

[Burks Pumps Home >>](#)

[Burks Pumps stock list >>](#)



Artisan Scientific

QUALITY INSTRUMENTATION ... GUARANTEED

Looking for more information?

Visit us on the web at <http://www.artisan-scientific.com> for more information:

- Price Quotations
- Drivers
- Technical Specifications, Manuals and Documentation

Artisan Scientific is Your Source for Quality New and Certified-Used/Pre-owned Equipment

- Tens of Thousands of In-Stock Items
- Hundreds of Manufacturers Supported
- Fast Shipping and Delivery
- Leasing / Monthly Rentals
- Equipment Demos
- Consignment

Service Center Repairs

Experienced Engineers and Technicians on staff in our State-of-the-art Full-Service In-House Service Center Facility

InstraView™ Remote Inspection

Remotely inspect equipment before purchasing with our Innovative InstraView™ website at <http://www.instraview.com>

We buy used equipment! We also offer credit for Buy-Backs and Trade-Ins

Sell your excess, underutilized, and idle used equipment. Contact one of our Customer Service Representatives today!

Talk to a live person: 888-88-SOURCE (888-887-6872) | Contact us by email: sales@artisan-scientific.com | Visit our website: <http://www.artisan-scientific.com>