



Artisan Technology Group is your source for quality new and certified-used/pre-owned equipment

- FAST SHIPPING AND DELIVERY
- TENS OF THOUSANDS OF IN-STOCK ITEMS
- EQUIPMENT DEMOS
- HUNDREDS OF MANUFACTURERS SUPPORTED
- LEASING/MONTHLY RENTALS
- ITAR CERTIFIED SECURE ASSET SOLUTIONS

SERVICE CENTER REPAIRS

Experienced engineers and technicians on staff at our full-service, in-house repair center

*InstraView*SM REMOTE INSPECTION

Remotely inspect equipment before purchasing with our interactive website at www.instraview.com ↗

WE BUY USED EQUIPMENT

Sell your excess, underutilized, and idle used equipment. We also offer credit for buy-backs and trade-ins. www.artisanng.com/WeBuyEquipment ↗

LOOKING FOR MORE INFORMATION?

Visit us on the web at www.artisanng.com ↗ for more information on price quotations, drivers, technical specifications, manuals, and documentation

Contact us: (888) 88-SOURCE | sales@artisanng.com | www.artisanng.com



Model 213 Quad Voltage Source

Quick Reference Guide





INTRODUCTION

This quick reference guide contains descriptions of the features and operation of the Model 213. Also included is a programming example using a PC controller.

©1990, Keithley Instruments, Inc.
All Rights Reserved
Instruments Division
Cleveland, Ohio, U. S. A.
Document Number: 213-903-01 Rev. A



TABLE OF CONTENTS

SAFETY WARNINGS	5
FRONT PANEL FAMILIARIZATION	7
REAR PANEL FAMILIARIZATION	9
DIP SWITCH	9
ANALOG OUTPUT PORTS	9
DIGITAL INPUT/OUTPUT PORTS	10
BASIC OPERATION	13
DAC PORT TRIGGERING	13
INTERNAL BUFFER	14
CONTROL MODES	16
IEEE-488 PROGRAMMING	19
DEVICE-DEPENDENT COMMANDS	19
SRQ MASK AND SERIAL POLL BYTE	31
STATUS WORDS	32
KEYBOARD CONTROLLER PROGRAM	38





SAFETY WARNINGS

The following safety warnings should be observed before using Model 213 Quad Voltage Source. Refer to main manual for detailed safety information and complete operation instructions.

The Model 213 Quad Voltage Source is intended for use by qualified personnel who recognize shock hazards and are familiar with the safety precautions required to avoid possible injury. Read over the manual carefully before using the instrument.

Before operating the instrument, make sure the line cord is connected to a properly grounded power receptacle.

Exercise extreme caution when a shock hazard is present. Lethal voltages may be present on connector jacks. The American National Standards Institute (ANSI) states that a shock hazard exists when voltage levels greater than 30V RMS or 42.4V peak are present. ***A good safety practice is to expect that hazardous voltage is present in any unknown circuit before measuring.***

Inspect the connecting cables, test leads, and jumpers for possible wear, cracks, or breaks before each use.

For maximum safety, do not touch the Quad Voltage Source connections, test cables or connections to any other instruments while power is applied to the circuit under test. Turn off all power and discharge any capacitors before connecting or disconnecting cables or jumpers.



Do not touch any object which could provide a current path to the common side of the circuit under test or power line (earth) ground.

Do not exceed the maximum signal levels of the instrument, as shown on the rear panel and as defined in the specifications and operation section of the instruction manual.

Instrumentation and accessories should not be connected to humans.

Maintenance should only be performed by qualified service personnel. Before performing any maintenance, disconnect the line cord and all test cables from the instrument.



FRONT PANEL FAMILIARIZATION

Six LEDs on the front panel of the Model 213 Quad Voltage Source display the status of the interface (see Figure 1).

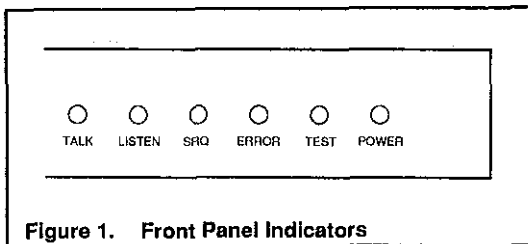

Figure 1. Front Panel Indicators

TALK — On when the unit is in the talker state, off when the unit is in the idle or listener state.

LISTEN — On when the unit is in the listener state, off when the unit is in the idle or talker state.

SRQ — On when the unit has generated a service request, off when no SRQ is pending. (See Service Request Mask command for more information.)

ERROR — On when an error has occurred, off when no error condition exists. (See Error Query command for more information.)



TEST — Used in conjunction with the Test command to verify that communication has been established with the unit. The TEST light will flash when the unit is calibrating in the auto-calibration mode. It will then remain lit when finished.

POWER — On when power is applied to the unit and the power switch on the back panel is in the on position (depressed). Off if power is not present.

+

REAR PANEL FAMILIARIZATION

DIP SWITCH

The Model 213 has one 8-position switch (SW1) accessible from the rear panel. This switch determines the unit's IEEE address and its operating mode (normal or auto-calibration). The switch is read only when the unit is powered on and should be set prior to applying power. Figure 2 illustrates the factory default setting for SW1.

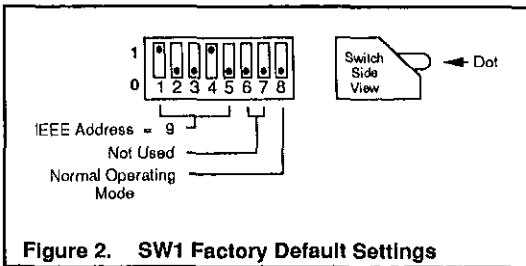

ANALOG OUTPUT PORTS

The Model 213 can be thought of as four isolated digital to analog converters occupying one IEEE-488 bus address. Each port has a low (L), high (H), and ground

+



(chassis ground) line. Chassis ground may be connected to the shield of shielded cable if this type of cable is used to carry the analog signals.

CAUTION

The maximum common-mode input voltage (the voltage between output LO and chassis ground) is 500V peak. Exceeding this value may damage the interface.

The pinouts for all four analog ports are labeled on the rear panel of the unit and are shown in Figure 3. Each analog output is capable of sourcing and sinking a maximum current of 10mA.

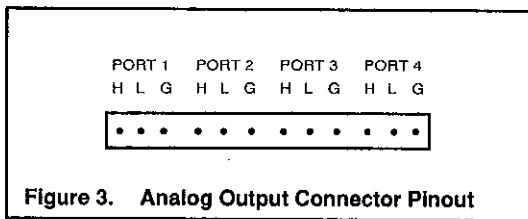

Figure 3. Analog Output Connector Pinout

DIGITAL INPUT/OUTPUT PORTS

The Model 213 has eight digital input lines and eight digital output lines.

Figure 4 illustrates the digital I/O edge connector as viewed from the rear of the instrument.

+

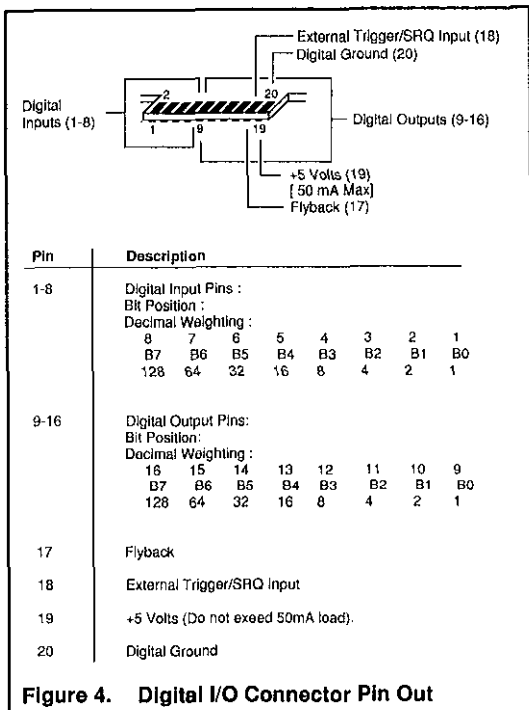

The digital output lines will drive two TTL loads. All digital input lines are less than 1.5 TTL loads. Normal precautions should be taken to limit the input voltages to -0.3 to $+7.0$ volts. All I/O lines are referenced to digital ground (pin 20).

+



In addition to interfacing with TTL logic levels, the digital output lines can be configured as high voltage/high current outputs. These outputs can sink up to 100mA at 50V DC through the use of open collector drivers with integral diodes for inductive load transient suppression. This allows for interfacing the digital outputs with relays, lamps and solenoids.

To configure the digital output lines for this purpose, it is necessary to open the enclosure and reposition the configuration jumper according to the procedure in Section 6 of the Model 213 Instruction Manual.



BASIC OPERATION

DAC PORT TRIGGERING

Triggering is the process of changing a DAC output at the occurrence of a trigger event. The three trigger events which can trigger a DAC port are: a Command Trigger (@), an IEEE Group Execute Trigger (GET), or an external trigger pulse applied to the external trigger/SRQ input. Any DAC port may be configured to trigger on one or more of these trigger sources. These trigger sources and their relationship to a DAC port are shown in Figure 5.

As shown in the diagram, the trigger sources are routed to the ports using the trigger mask commands. The trigger mask commands are illustrated as switches. They are used to enable a trigger source to trigger the selected DAC port. All trigger signals are then combined to allow a port to be triggered upon the occurrence of any of the three trigger events.

Operation of the Model 213 is controlled by an internal 1msec timer. Each DAC port is updated at a maximum rate of once every millisecond. When a trigger event occurs, the DAC will output the programmed voltage within 1msec of receiving the trigger.



+

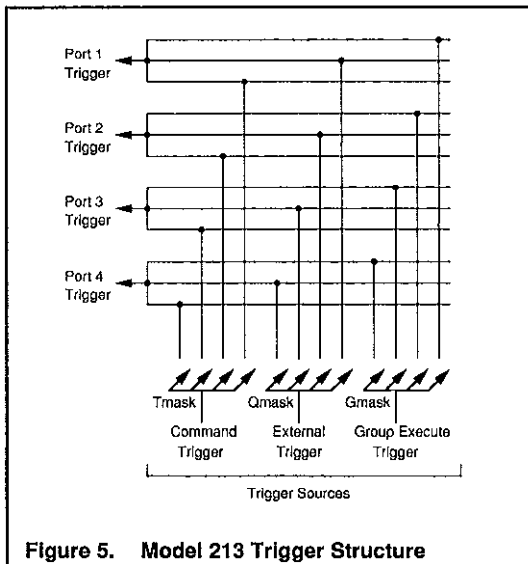

INTERNAL BUFFER

The Model 213 contains an internal buffer consisting of 8192 locations numbered 0 to 8191. The buffer is shared by all ports. Each port may be given a different section of the buffer or ports may use the same buffer locations without conflict.

This buffer may be loaded with voltage values to be output when the stepped or waveform modes are used. All

+

+

data in the internal buffer is saved in non-volatile RAM. Therefore buffer data which was previously loaded will be available at power on.

Figure 6 shows the factory default allocation of the internal buffer to each of the DAC ports on the Model 213.

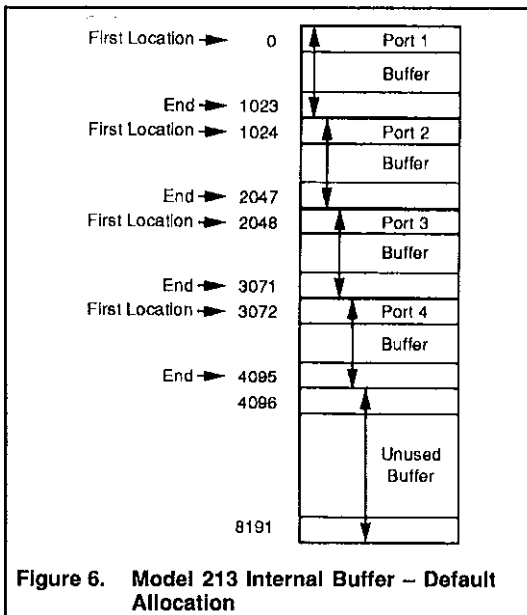

+



CONTROL MODES

Four modes of DAC port operation are available: direct, indirect, stepped, and waveform. Each port is independent and may be operated in a different mode.

Direct Control Mode

In the direct control mode, a DAC voltage is output upon receipt of the Execute (X) command. Direct control is accomplished by selecting the DAC port, the range or autorange, specifying the DAC output voltage, and issuing the Execute command.

Indirect Control Mode

Indirect control implies that the DAC output will change only when a trigger event occurs. Indirect control is accomplished by selecting the DAC port, the range or autorange, specifying the DAC output voltage and the desired trigger source. When the trigger event occurs, the programmed voltage will be output.

Stepped Mode

In this mode, a sequence of DAC voltages is loaded into the Model 213 internal buffer. After the voltages are loaded into the buffer, the DAC output can then be stepped through each of the values by using any of the three trigger sources. When the last voltage in the buffer





is output, the Model 213 will automatically return to the first location, thereby allowing the sequence to be repeated. See Figure 7.

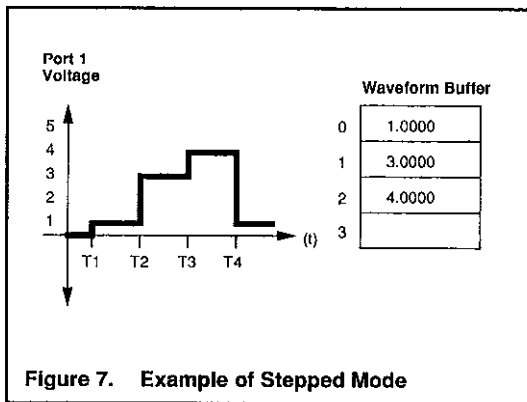

Waveform Mode

The waveform control mode may be used to control the DAC in an automatic manner. A buffer is defined and voltage values are loaded into the buffer. Once the Model 213 is triggered, these preloaded voltage values are then output at a regular interval. See Figure 8.

When the last voltage in the buffer is output, the Model 213 will remain at that location if the number of cycle has been reached. The voltage stored at this location is then output continuously. If the specified number of cycles has



+

not been reached, the Model 213 automatically continues at the first buffer location.

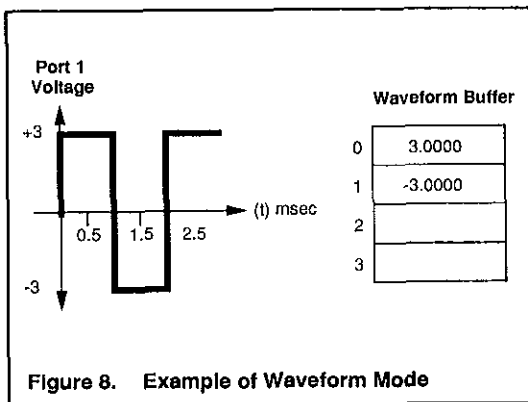

+



IEEE-488 PROGRAMMING

DEVICE-DEPENDENT COMMANDS

Trigger (system command)	
-------------------------------------	--

@	Command trigger. Triggers the ports in the command trigger mask (Tmask). This command does not require the Execute (x) command to operate.
---	--

Autorange (port command)	
-------------------------------------	--

A0	Disable autorange for selected DAC port
A1 (default)	Enable autorange for selected DAC port
A?	Returns current autorange setting.



Buffer Data (port command)	
Brng,volts	Write volts value in buffer location for selected DAC port.
Brng,#val	Write decimal bit value in buffer location for selected DAC port.
Brng,#\$valZ	Write hexadecimal bit value in buffer location for selected DAC port.
B?	Returns the range and value at the location pointer for the selected DAC port in the format specified by the Output Format (On) command. <i>Notes:</i> <ol style="list-style-type: none">1. This command increments the location counter after the value is written to or read from the buffer.2. Factory default vlaues are rng=0, volts=0.3. Valid values are rng=0-3, volts= number without a V prefix.

Control Mode (port command)	
C0 (default)	Direct mode
C1	Indirect mode
C2	Stepped mode
C3	Waveform mode
C?	Returns current control mode for selected port <i>Notes:</i> Selecting a control mode stops the prior mode activity and rearms the port for the selected mode.



Digital Output (system command)	
Dval	Outputs the value on the digital output port.
D?	Returns the current value of the digital output port. Notes: 1. Default output value = 0. 2. val = 0-255.

Error Query (port command)	
E?	Returns the error status which indicates the last error encountered.
Error Status Codes:	
E0	No error
E1	Invalid command
E2	Invalid command parameter
E3	Command conflict
E4	Calibration write protected
E5	Non-volatile RAM error
Notes: Upon reading the error status the error is cleared.	





Buffer Definition (port command)	
Fstart,size	Specifies starting location and number of locations used in the internal buffer for the selected port. $0 \leq \text{start} \leq 8191$; $1 \leq \text{size} \leq 8192$.
F?	Returns the starting buffer location and number of locations used in the defined buffer. <i>Notes:</i> The sum of start+size must be less than or equal to 8192. The default values are 0,1024; 1024, 1024; 2048, 1024; and 3072, 1024 for ports 1 thru 4 respectively.

Get Trigger Mask (system command)	
Gmask	Sets bits in the GET trigger mask which specifies which ports will be triggered upon receipt of a bus GET command.
G-mask	Clears the specified bits in the GET trigger mask.
G0	Clears all bits in the GET trigger mask.
G?	Returns current GET trigger mask.
The mask bits are as follows:	
Bit 0	Enable trigger to DAC port 1 (1).
Bit 1	Enable trigger to DAC port 2 (2).
Bit 2	Enable trigger to DAC port 3 (4).
Bit 3	Enable trigger to DAC port 4 (8).
<i>Notes:</i> The default mask value is 0.	



Offset Calibration (port command)	
Hval	Specifies the offset constant for selected range and port. Range is ± 255 .
H?	Returns the offset constant for selected range and port. <i>Notes:</i> Calibration constants must be programmed while using the direct control mode (C0). Autorange must be disabled to program calibration constants. The current voltage output is retriggered upon execution of this command. Default value is 0.

Interval (port command)	
It	Specify time interval (in milliseconds) used with the waveform control mode. Range for t is 1-65535.
I?	Returns the current interval. <i>Notes:</i> The default value is 1000 (1 second).



Gain Calibration (port command)	
Jpos, neg	Specifies the gain constant for both polarities of the selected range and port. pos and neg = 0-255.
J?	Returns the gain constants for selected range and port. <i>Notes:</i> Calibration constants must be programmed while using the direct control mode (C0). Autorange must be disabled (A0) to program calibration constants. The current voltage output is retrigged upon execution of this command. Default values are 128, 128.

EOI Control (system command)	
K0	Assert EOI on last bus terminator.
K1 (default)	Disable EOI.
K?	Returns the current EOI control setting.

Location Pointer (port command)	
Lval	Specifies the current buffer location. Range for val is 0-8191.
L?	Returns the current buffer location in the format specified by the Output Format (On) command. The value returned after an L? is the first location that will be used in stepped and waveform modes.



Service Request Mask (system command)	
Mmask	Sets bits in the service request mask which specifies which Model 213 events will generate a bus service request.
M-mask	Clears the specified bits in the service request mask.
M0	Clears all bits in the service request mask.
M?	Returns current service request mask.
The mask bits are as follows:	
Bit 0	Enable SRQ on DAC port 1 ready for trigger (1).
Bit 1	Enable SRQ on DAC port 2 ready for trigger (2).
Bit 2	Enable SRQ on DAC port 3 ready for trigger (4).
Bit 3	Enable SRQ on DAC port 4 ready for trigger (8).
Bit 4	Enable SRQ on Trigger Ovrerrun (16).
Bit 5	Enable SRQ on error (32).
Bit 7	Enable SRQ on External input transition (128).

Number of Cycles (port command)	
Nval	Specifies the number of cycles through the buffer in the waveform mode. val is 0-65535, where 0 is continuous.
N?	Returns the number of repetitions specified for use in the waveform mode. <i>Notes:</i> The default value is 1.



+

Output Format (system command)	
O0 (default)	Sets output format to volts in ± 10.0000 (fixed).
O1	Sets output format in volts in decimal bits.
O2	Sets output format in volts in hexadecimal bits.
O?	Returns current output format selected.

Port Select (system command)	
P1 (default)	Select DAC port 1.
P2	Select DAC port 2.
P3	Select DAC port 3.
P4	Select DAC port 4.
P?	Returns currently selected port.



External Trigger Mask (system command)	
Qmask	Sets bits in the external trigger mask which specifies the active edge of the external input line and which ports will be triggered upon a transition of that line.
Q-mask	Clears the specified bits in the external trigger mask.
Q0	Clears all bits in the external trigger mask.
Q?	Returns current external trigger mask.
The mask bits are as follows:	
Bit 0	Enable trigger to DAC port 1 (1).
Bit 1	Enable trigger to DAC port 2 (2).
Bit 2	Enable trigger to DAC port 3 (4).
Bit 3	Enable trigger to DAC port 4 (8).
Bit 7	External input line edge sense: (128) 1=negative edge triggered 0=positive edge triggered
<i>Notes:</i> The bit 7 default value is 0.	

Range Select (port command)	
R0	Select DAC Ground range.
R1 (default)	Select DAC $\pm 1V$ range.
R2	Select DAC $\pm 5V$ range.
R3	Select DAC $\pm 10V$ range.
R?	Returns DAC volt range.
<i>Notes:</i> This command should not be used when <i>autorange</i> is enabled.	





System Defaults (system command)	
S0	Restores the factory default value to NV-RAM.
S1	Saves the current settings as default values to NV-RAM.
S2	Restores Gain and Offset cal constants.
S3	Saves current calibration constants to calibration NV-RAM.
S?	Returns the last Sn command executed.

Command Trigger Mask (system command)	
Tmask	Sets bits in the command trigger mask which specifies which ports will be triggered upon receipt of a trigger command (@).
T-mask	Clears the specified bits in the command trigger mask.
T0	Clears all bits in the command trigger mask.
T?	Returns current command trigger mask.
The mask bits are as follows:	
Bit 0	Enable trigger to DAC port 1.
Bit 1	Enable trigger to DAC port 2.
Bit 2	Enable trigger to DAC port 3.
Bit 3	Enable trigger to DAC port 4.
<i>Notes:</i> The default value is 0.	





Status (system command)	
U0	Send system status on talk.
U1	Send DAC port 1 status on talk.
U2	Send DAC port 2 status on talk.
U3	Send DAC port 3 status on talk.
U4	Send DAC port 4 status on talk.
U5	Send digital input port status on talk.
U6	Send overrun status on talk.
U7	Returns actual output voltage and range.
U8 (default)	Returns programmed output voltage and range.
U?	Returns current status select setting. <i>Notes: All status commands are one shot.</i>

Value Output (port command)	
Vvolts	Write volts value for selected DAC port.
V#val	Write decimal bit value for selected DAC port.
V#\$valZ	Write hexadecimal bit value for selected DAC port.
V?	Returns current range and value for selected port in the format specified by the Output Format (On) command. <i>Notes: The current autorange and range affect the value. When programming in bits, autorange must be disabled. The digital port must be programmed in bits.</i>

+

Test (system command)	
W0 (default)	Turn off TEST LED.
W1	Turn on TEST LED.
W?	Return state of TEST LED.

Execute (system command)	
X	Execute command string.

Bus Terminator (system command)	
Y0 (default)	Bus terminator is carriage return line feed.
Y1	Bus terminator is line feed carriage return.
Y2	Bus terminator is carriage return only.
Y3	Bus terminator is line feed only.
Y?	Returns current bus terminator setting.

+

+

SRQ MASK AND SERIAL POLL BYTE

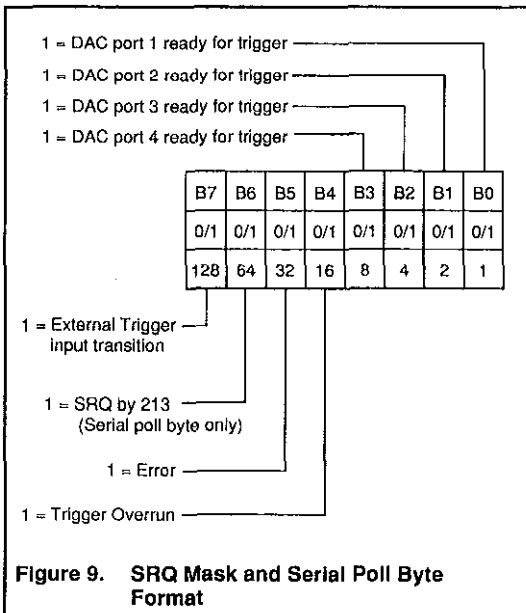

+



STATUS WORDS

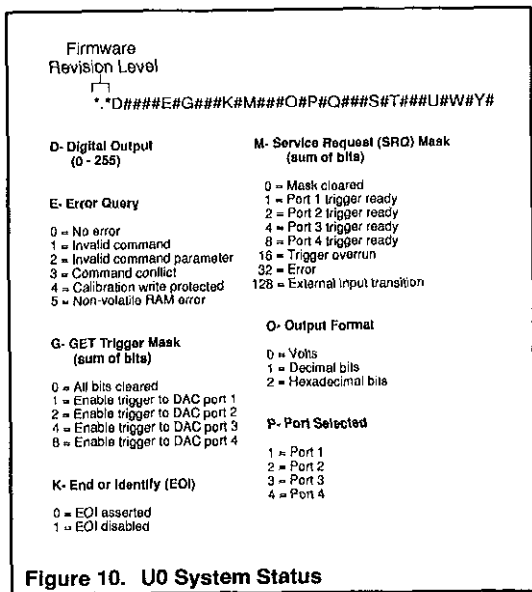



**Q- External Trigger Mask
(sum of bits)**

- 0 = All bits cleared
- 1 = Enable external trigger on port 1
- 2 = Enable external trigger on port 2
- 4 = Enable external trigger on port 3
- 8 = Enable external trigger on port 4
- 128 = External input is negative edge triggered

S- System Defaults

- 0 = Restore factory default to NV-RAM
- 1 = Save current settings as default to NV-RAM
- 2 = Restore cal. constants to cal. NV-RAM
- 3 = Save cal. constants to cal. NV-RAM

**T- Command Trigger Mask
(sum of bits)**

- 0 = All bits cleared
- 1 = Enable command trigger on port 1
- 2 = Enable command trigger on port 2
- 4 = Enable command trigger on port 3
- 8 = Enable command trigger on port 4

U- Status on Talk

- 0 = Send system status
- 1 = Send DAC port 1 status
- 2 = Send DAC port 2 status
- 3 = Send DAC port 3 status
- 4 = Send DAC port 4 status
- 5 = Send digital input port status
- 6 = Send overrun status
- 7 = Returns actual output voltage and range
- 8 = Returns programmed output voltage and range

W- Test

- 0 = Turn off TEST LED
- 1 = Turn on TEST LED

Y- Terminator

- 0 = CRLF
- 1 = LF CR
- 2 = CR
- 3 = LF

U0 System Status (Cont.)





A#C#F#####L#####N#####P#R#V#.#####

A - Autorange

- 0 = Disabled
- 1 = Enabled

C - Control Mode

- 0 = Direct mode
- 1 = Indirect mode
- 2 = Stepped mode
- 3 = Waveform mode

F - Buffer Definition

(start, size)

- 0 ≤ start ≤ 8191
- 1 ≤ size ≤ 8192

I - Interval

(1 - 85535msec)

L - Location Pointer

(0 - 8191)

N - Number of Cycles

(0 - 65535)

P - Port Selected

- 1 = DAC port 1
- 2 = DAC port 2
- 3 = DAC port 3
- 4 = DAC port 4

R - Range Selected

- 0 = DAC ground range
- 1 = DAC ± 1V range
- 2 = DAC ± 5V range
- 3 = DAC ± 10V range

V - Value Output

(programmed output voltage)

Figure 11. U1-U4 Port Status



+

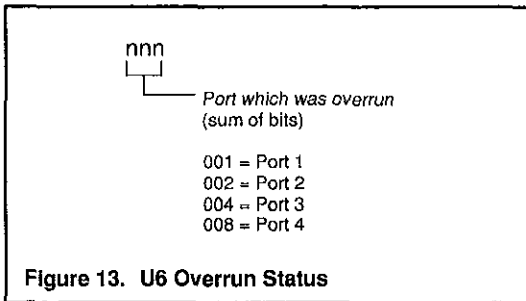
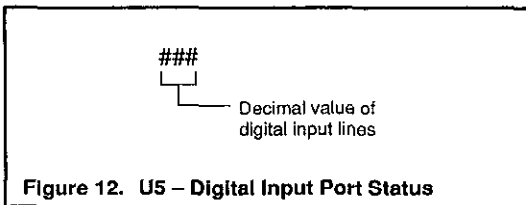

+

+

C#P#R#V±##.#####

C - Control Mode

- 0 = Direct mode
- 1 = Indirect mode
- 2 = Stepped mode
- 3 = Waveform mode

P - Port Selected

- 1 = DAC port 1
- 2 = DAC port 2
- 3 = DAC port 3
- 4 = DAC port 4

R - Range Selected

- 0 = DAC ground range
- 1 = DAC ± 1V range
- 2 = DAC ± 5V range
- 3 = DAC ± 10V range

Note: If autorange is enabled, the present range parameter is returned.

V - Value Output

(actual output voltage)

Figure 14. U7 Actual Output Voltage and Range

+

+

A#C#P#R#V±##.#####

A - Autorange

- 0 = Disabled
- 1 = Enabled

C - Control Mode

- 0 = Direct mode
- 1 = Indirect mode
- 2 = Stepped mode
- 3 = Waveform mode

P = Port Selected

- 1 = DAC port 1
- 2 = DAC port 2
- 3 = DAC port 3
- 4 = DAC port 4

R - Range Selected

- 0 = DAC ground range
- 1 = DAC ±1V range
- 2 = DAC ±5V range
- 3 = DAC ±10V range

V - Value Output

(programmed output voltage)

Figure 15. U8 Programmed Output Voltage and Range

+



KEYBOARD CONTROLLER PROGRAM

The keyboard controller program is a simple BASIC program that accepts commands from the PC keyboard and sends them to an IEEE-488 interface with the IOtech Driver488 software. It then displays any responses on the PC screen. The keyboard controller program is a convenient method of exercising the Model 213 and becoming familiar with the commands and their actions.

```
10  ' Keyboard Controller Program
20  '
30  ' For use with the IOtech Driver488 and an
40  ' IEEE-488 interface
50  '
100 OPEN "\DEV\IEEEOUT" FOR OUTPUT AS #1
110 IOCTL#1,"BREAK"
120 PRINT#1,"RESET"
130 OPEN "\DEV\IEEEIN" FOR INPUT AS #2
140 '
150 ON ERROR GOTO 300
160 PRINT#1,"ERROR OFF"
170 '
180 LINE INPUT "CMD> ",CMD$
190 PRINT#1,CMD$
200 '
210 IF IOCTL$(2) <> "1" THEN 180
```



+

```
220 PRINT INPUT$(1,2);
230 GOTO 210
290 '
300 ' Error Handler
310 '
320 IOCTL#1,"BREAK"
330 PRINT#1,"STATUS"
340 INPUT#2,ST$
350 PRINT CHR$(7);"Error #";MID$(ST$,15,2);": ";MID$(ST$,27)
360 RESUME NEXT
```

+

Specifications are subject to change without notice.
All Keithley trademarks and trade names are the property of
Keithley Instruments, Inc. All other trademarks and trade names
are the property of their respective companies.



Keithley Instruments, Inc.

28775 Aurora Road • Cleveland, Ohio 44139

440-248-0400 • Fax: 440-248-6168

1-888-KEITHLEY (534-8453) www.keithley.com

© Copyright 2000 Keithley Instruments, Inc.
Printed in the U.S.A.

04/2001



Artisan Technology Group is your source for quality new and certified-used/pre-owned equipment

- FAST SHIPPING AND DELIVERY
- TENS OF THOUSANDS OF IN-STOCK ITEMS
- EQUIPMENT DEMOS
- HUNDREDS OF MANUFACTURERS SUPPORTED
- LEASING/MONTHLY RENTALS
- ITAR CERTIFIED SECURE ASSET SOLUTIONS

SERVICE CENTER REPAIRS

Experienced engineers and technicians on staff at our full-service, in-house repair center

*InstraView*SM REMOTE INSPECTION

Remotely inspect equipment before purchasing with our interactive website at www.instraview.com ↗

WE BUY USED EQUIPMENT

Sell your excess, underutilized, and idle used equipment. We also offer credit for buy-backs and trade-ins. www.artisanng.com/WeBuyEquipment ↗

LOOKING FOR MORE INFORMATION?

Visit us on the web at www.artisanng.com ↗ for more information on price quotations, drivers, technical specifications, manuals, and documentation

Contact us: (888) 88-SOURCE | sales@artisanng.com | www.artisanng.com