



Artisan Technology Group is your source for quality new and certified-used/pre-owned equipment

- FAST SHIPPING AND DELIVERY
- TENS OF THOUSANDS OF IN-STOCK ITEMS
- EQUIPMENT DEMOS
- HUNDREDS OF MANUFACTURERS SUPPORTED
- LEASING/MONTHLY RENTALS
- ITAR CERTIFIED SECURE ASSET SOLUTIONS

SERVICE CENTER REPAIRS

Experienced engineers and technicians on staff at our full-service, in-house repair center

*InstraView*SM REMOTE INSPECTION

Remotely inspect equipment before purchasing with our interactive website at www.instraview.com ↗

WE BUY USED EQUIPMENT

Sell your excess, underutilized, and idle used equipment. We also offer credit for buy-backs and trade-ins. www.artisanng.com/WeBuyEquipment ↗

LOOKING FOR MORE INFORMATION?

Visit us on the web at www.artisanng.com ↗ for more information on price quotations, drivers, technical specifications, manuals, and documentation

Contact us: (888) 88-SOURCE | sales@artisanng.com | www.artisanng.com



GENERAL PURPOSE INCUBATORS

MODELS: 5015, 5025

INSTALLATION AND OPERATION MANUAL

Sheldon Manufacturing Inc. P P.O. Box 627 P Cornelius, Oregon 97113
EMAIL: tech@Shellab.com P **INTERNET:** <http://www.Shellab.com/~Shellab>
1-800-322-4897 (503) 640-3000 FAX (503) 640-1366

TABLE OF CONTENTS

SECTION 1.0	RECEIVING AND INSPECTION
SECTION 2.0	INSTALLATION
SECTION 3.0	GRAPHIC SYMBOL
SECTION 4.0	CONTROLS OVERVIEW
SECTION 5.0	OPERATION
SECTION 6.0	FYRITE READING
SECTION 7.0	MAINTENANCE
SECTION 8.0	TROUBLESHOOTING
SECTION 9.0	PARTS LIST
	UNIT SPECIFICATIONS
	SCHEMATICS

REV. 7/99
4861390

These units are general purpose air incubators for professional, industrial or educational use where the preparation or testing of materials is done at approximately atmospheric pressure and no flammable, volatile or combustible materials are being heated. These units are not intended for hazardous or household locations or use.



RECEIVING AND INSPECTION

Your satisfaction and safety require a complete understanding of this unit. Read the instructions thoroughly and be sure all operators are given adequate training before attempting to put the unit in use. NOTE: This equipment must be used only for its intended application; any alterations or modifications will void your warranty.

- 1.1 **Inspection:** The carrier, when accepting shipment, also accepts responsibility for safe delivery and is liable for loss or damage. On delivery, inspect for visible exterior damage, note and describe on the freight bill any damage found, and enter your claim on the form supplied by the carrier.
- 1.2 Inspect for concealed loss or damage on the unit itself, both interior and exterior. If any, the carrier will arrange for official inspection to substantiate your claim.
- 1.3 **Return Shipment:** Save the shipping crate until you are sure all is well. If for any reason you must return the unit, contact your service representative for authorization and supply the data plate information. Please see the manual cover for information on where to contact Customer Service.
- 1.4 **Accessories:** Verify that your accessory kit is complete. The 5015 is equipped with 3 shelves, 12 shelf clips, supply hose kit and 4 leveling feet. The 5025 is equipped with 6 shelves, 24 shelf clips, supply hose kit and 4 leveling feet. Check all packaging materials before discarding.

INSTALLATION

Local city, county, or other ordinances may govern the use of this equipment. If you have any questions about local requirements, please contact the appropriate local agency. Installation may be performed by the end user.

Under normal circumstances this unit is intended for use indoors, at room temperatures between 5° and 40°C, at no greater than 80% Relative Humidity (at 25°C) and with a supply voltage that does not vary by more than 10%. Customer service should be contacted for operating conditions outside of these limits.

- 2.1 Power Source:** Check the data plate for voltage, cycle, phase and ampere requirements. Plug the unit into a properly grounded and rated outlet of the correct style. **VOLTAGE SHOULD NOT VARY MORE THAN 10% FROM THE DATA PLATE RATING.** These units are intended for 50/60 Hz application. A separate circuit is recommended to preclude loss of product due to overloading or circuit failure. **NOTE:** Electrical supply to the unit must conform to all national and local electrical codes.
- 2.2 Location:** In selecting a location, consider all conditions which might affect performance, such as heat from radiators, ovens, autoclaves, etc. Avoid direct sun, fast-moving air currents, heating/cooling ducts and high-traffic areas. To ensure air circulation around the unit, allow a minimum of 5cm between the unit and walls or partitions which might obstruct free air flow.
- 2.3 Lifting / Handling:** These units are heavy and care should be taken to use appropriate lifting devices that are sufficiently rated for these loads. Units should only be lifted from their bottom surfaces. Doors, handles and knobs are not adequate for lifting or stabilization. The units should be completely restrained from tipping during lifting and transport. All moving parts, such as shelves and trays should be removed and doors need to be positively locked in the closed position during transfer to prevent shifting and damage.
- 2.4 Leveling:** The unit must sit level and solidly. Leveling feet are supplied and must be installed in the four holes in the bottom corners of the unit. With the feet installed and the unit standing upright, each foot can be raised by turning it in a counterclockwise direction. Adjust the foot at each corner until the unit stands level and solid without rocking. If the unit is to be moved, turn the leveling feet all the way clockwise to prevent damage while moving.

2.5 Cleaning: The unit chamber should be cleaned and disinfected prior to use. Remove all of the interior parts, if assembled, and clean thoroughly, including all corners using a disinfectant that is appropriate for your application. Regular periodic cleaning is required. Special care should be taken when cleaning around sensing heads to prevent damage. **DO NOT USE** chlorine-based bleaches or abrasives as these will damage the stainless steel interior. **DO NOT USE** spray cleaners that might leak through openings and cracks and get on electrical parts or that may contain solvents that will harm the coatings.

WARNING: Never clean the unit with alcohol or flammable cleaners with the unit connected to the electrical supply. Always disconnect the unit from the electrical service when cleaning and assure all volatile or flammable cleaners are evaporated and dry before reattaching the unit to the power supply.





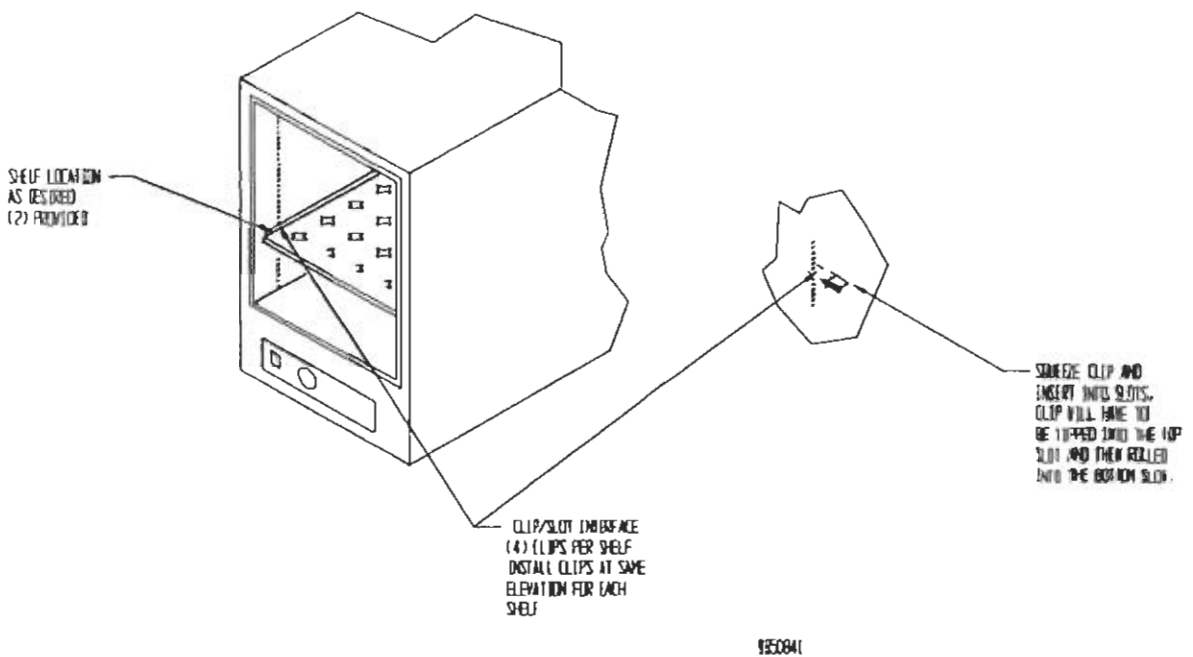



2.6 Place shelves in chamber as desired. See **Figure One**.

Figure One



GRAPHIC SYMBOLS

Your CO₂ incubator is provided with a display of graphic symbols on the control panel which are designed to help identify the use and function of the adjustable components.

1.  Indicates that you should consult your manual for further description and discussion of a control or user item.
2.  Indicates "Temperature"
3.  Indicates "Overtemperature"
4. $^{\circ}\text{C}$ Indicates "Degrees Centigrade"
5.  Indicates "AC Power"
6.  Indicates "Manual Adjustment"
7.  Indicates "Purge"
8.  Indicates "Potential Shock Hazard" behind partition
9.  Indicates "Earth Ground"

CONTROLS OVERVIEW

- 4.1 **Power Switch:** The main power I/O (On/Off) switch controls all power to the unit. It must be in the I/On position before any systems are operational. The digital display is activated when the power is turned ON.
- 4.2 **Main Temperature Control:** This control is marked SET TEMPERATURE and consists of the digital display and UP/DOWN arrow pads for inputting set point temperature and calibration.
- 4.3 **Overtemperature Thermostat:** This control is marked SET OVERTEMPERATURE and is equipped with an adjustment knob and a graduated dial from "0 to 10". Completely independent of the Main Controller, the Overtemperature Thermostat guards against any failure of the Main Controller which would allow temperature to rise past set point. If temperature rises to the Overtemperature set point, the thermostat takes control of the heating element and allows continued use of the incubator until the problem can be resolved or service can be arranged. It is not recommended that the unit be allowed to operate for an extended period of time using only the Overtemperature as temperature uniformity will suffer.
- 4.4 **HEATING Light:** This pilot light is marked HEATING ACTIVATED and is ON when the unit is heating up to set point and is blinking when controlling temperature at set point.
- 4.5 **OVERTEMP Light:** This pilot light is marked OVERTEMP ACTIVATED and is ON when the Overtemperature Thermostat has been activated. Under normal operating conditions this light should never come on.
- 4.6 **Fuse:** Located within the power inlet, the fuse offers protection against power source variations. When blown the unit will shut down and the fuse must be replaced once the source of the interruption has been cleared.
- 4.7 **CO₂ Sample Port:** A sample of chamber atmosphere can be taken from the sample port located on the upper right side of the unit. CO₂ concentration can then be checked with a Fyrite gas analyzer or other instrument such as a gas chromatograph.
- 4.8 **Air In Port:** This port marked AIR TO CHAMBER is located on the upper right

side of the unit, and where the air supply enters the chamber.

- 4.9 CO₂ In Port:** This port marked CO₂ TO CHAMBER is adjacent to the AIR port and is where the CO₂ supply enters the chamber.
- 4.10 CO₂ Flow Meter:** Located near the right end of the control panel, the valve marked CO₂ at the base of the meter is used to regulate flow of CO₂ to the incubator chamber.
- 4.11 Air Flow Meter:** Adjacent to the CO₂ meter, the valve marked AIR at the base of the meter is used to regulate flow of air to the incubator.
- 4.12 Purge Timer:** The Purge Timer recreates proper CO₂ and Air ratios by injecting CO₂ into the chamber after the glass door is opened. It operates independently of the flow meter.
- 4.13 Activate Purge:** This push button switch is used to activate the purge for the specified time set on the purge timer.

OPERATION

- 5.1 Check power supply against unit serial plate; they must match. Be certain that the fuse is installed in the power inlet of the unit. Plug service cord into the electrical outlet.
- 5.2 Push power switch to the ON position, and turn the High Limit Thermostat to its maximum position, clockwise. Temperatures must be set before CO₂ connection and adjustments are made.
- 5.3 **Set Main Temperature Control:** Enter desired set point temperature. To enter set point mode on the control, press either the Up or Down button one time. The digital display will start to blink, going from bright to dim. While blinking, the digital display is showing the set point. To change the set point, use the Up and Down buttons. If the buttons are not pressed for five (5) seconds, the display will stop blinking and will read the temperature in the chamber. Allow the incubator at least 24 hours stabilize.
- 5.4 **Calibration Procedure:** It is recommended that calibration is done once the unit is installed in its working environment and has been stable at set point for several hours. Place a certified reference thermometer in the chamber. Be certain the thermometer is raised off the shelf and NOT touching any metal. Allow the temperature to stabilize again until the thermometer reads a constant value for one hour. Compare the digital display with the reference thermometer. If there is an unacceptable difference, put the display into calibration mode by pressing both the Up and Down arrow pads at the same time for approximately five (5) seconds until the two outside decimal points begin to flash. While the decimal points are flashing the display can be calibrated to match the reference thermometer by pressing the Up and Down arrow pads until the display reads the correct value. Allow the incubator temperature to stabilize and repeat calibration if necessary.
- 5.5 **Set Overtemperature Thermostat:** As mentioned in step 5.2 the Overtemperature Thermostat should be initially set to its maximum position to allow the unit to stabilize. Once the incubator is stable at the desired set point, turn the thermostat counterclockwise until the OVERTEMP ACTIVATED light turn on. Next, turn the Thermostat clockwise just until the light turns off. Then turn the Thermostat clockwise again, two minor increments on the dial past the point where the light went out. This will set the Overtemperature Thermostat at approximately 1°C above Main Temperature set point.

5.6 Connecting CO₂ Regulator to CO₂ Storage Tank:

- A. Use only a two-stage pressure regulator made for CO₂. You will obtain the best results if the final output pressure gauge range is 0-30 PSI. NOTE: Some single-stage regulators have 2 gauges. These are not the same as a two-stage regulator. Be certain you are using a two-stage regulator.
- B. Connect the CO₂ regulator to the CO₂ tank, making sure to place the gasket, supplied with the CO₂ regulator, between CO₂ tank outlet and regulator. Set final output gauge at 20 PSI.
- C. Use only medical grade CO₂ to avoid contamination of flow lines and incubator chamber.

NOTE: For accurate settings, make sure the CO₂ pressure from supply tank remains constant throughout setting procedures and future operations.

5.7 Connecting CO₂ to Incubator: (If optional tank switch is not used) Connect the CO₂ Regulator of the CO₂ supply tank to the CO₂ IN port by means of, the supply hose kit from your accessories package.

5.8 Attaching Air Supply to Incubator: Attach your air supply to the AIR IN port, on the upper right side of the unit, marked AIR.

- A. Use a lightweight industrial pump or a high quality aquarium pump. (Minimum output: 2LPM, maximum output: 5LPM)
- B. If using an in-house system, a C.A. Norgren Regulator (Model B07-18A) is recommended. You may also wish to use a filter for a clean air supply.

5.9 Setting CO₂ and Air Flow Rates: Adjust the Air Flow valve so that the steel ball in the flow meter floats at "2". Set the CO₂ Flow Valve according to the desired percentage. The chart below is a useful guide; however, the settings are not absolute. Measure the CO₂ percentage, after allowing at least 4 hours between CO₂ adjustments for proper stabilization, then increase or decrease CO₂ flow until achieving relative percentages.

WARNING: Do not use valve at the base of meter for CO₂ shut-off when unit is out of service. Shut CO₂ off at tank.

<u>Percentage CO₂</u>	<u>Setting</u>
→ 5%	100cc
7.5%	150cc
10%	200cc

5.10 Setting Purge Timer: The purpose of the PURGE is to recover the CO₂ percent in the chamber after the door has been opened. The following procedure is explained with the assumption that 5% is the desired CO₂ percentage and the incubator temperature is stable at set point. If you desire a higher CO₂ level, proportionally increase the setting on the Purge Timer.

- A. Set the timer to 15 seconds.
- B. Open incubator for 30 seconds to empty CO₂ content. Close door.
- C. Push and release the ACTIVATE PURGE button, which will inject CO₂ into chamber over a 15 second interval. This re-establishes desired CO₂/Air ratio.
- D. Measure CO₂ % in chamber with Fyrite or gas chromatograph. See Section 6.0 for instruction on reading Fyrite.
- E. If CO₂ level in interior of incubator is above or below 5%, adjust timer up or down 1 or 2 increments. Allow at least 1 minute for stabilization before repeating the same procedure and measurement.

FYRITE READING

NOTE: Be sure to hold canister away from face. Do not press button with canister inverted.

1. Press button on top of Fyrite canister to release CO₂ Concentration. Tip canister to the side to ensure all fluid is released from top of canister.
2. Loosen screw on slide scale and align top fluid with zero on the scale. Tighten screw.
3. Connect hose and bulb to unit being tested. The sample port for connection is on the upper right side of the unit.
4. Place hose cap directly over button on top of canister and press firmly.
5. With button depressed, squeeze bulb 27 times. On the last squeeze, and with bulb still deflated, release hose from button.
6. Turn Fyrite canister upside down 3 times, each time allowing all fluid to flow to the opposite end of the canister.
7. Tip canister slightly to ensure all fluid has been released from top of canister.
8. Read CO₂ concentration in %.

To ensure accuracy, it is important to always follow the same procedure when taking Fyrite reading. Repeat process to confirm reading.

MAINTENANCE

NOTE: Prior to any maintenance or service on the unit, disconnect service cord from the power supply.

- 7.1 Cleaning:** Disinfect the incubator interior on a regular basis. To prepare the incubator for cleaning remove the shelves and shelf clips. These stainless steel parts are autoclavable.
- A.** First clean removed parts and interior with soap and water. To decontaminate use a disinfectant that is suitable for your application. **DO NOT USE** chlorine-based bleaches or abrasives as this will damage the stainless steel interior. **DO NOT USE** spray cleaners that might leak through openings and cracks and get on electrical parts or that may contain solvents that will harm the coatings.
- WARNING:** Never clean the unit with alcohol or flammable cleaners with the unit connected to the electrical supply. Always disconnect the unit from the electrical service when cleaning and assure all volatile or flammable cleaners are evaporated and dry before reattaching the unit to the power supply.
- B.** When washing the interior, handle the gasket carefully so as not to impair the positive seal.
- 7.2** Check CO₂ supply periodically; Do not let it run out. Automatic tank switches and "empty tank" alarms are available from your dealer.
- 7.3** Periodically check CO₂ supply lines and connections for leaks. Use a liquid-soap solution to detect leaks and look for bubbles.
- 7.4** Keep the CO₂ flow system free of impurities. Erratic CO₂ control is usually traceable to the CO₂ pressure regulator on the tank, impurities in the tank, or impurities in the solenoid valve. Replace CO₂ filters when noticeable dirty on the upstream side or every six (6) months. There is a CO₂ filter connected to the GAS-IN line inside the unit and accessible through the back and one attached to the supply hose kit.
- 7.5** If the incubator is turned off for an extended period of time it may be reactivated by simply turning it on and allowing 24 hours for recovery. **NO** adjustments are necessary. If the unit is shut down deliberately for storage disconnect the gas and power supply.

- 7.6 There is no maintenance required on the electrical components. If the incubator fails to operate as specified, see Section 8.0, Troubleshooting, before calling for service.

TROUBLESHOOTING

Always make a visual inspection of the incubator and control console when troubleshooting. Look for loose or disconnected wires or tubing which may be the source of the problem.

The incubator is designed so that no internal electrical servicing should be required under normal conditions. If electrical servicing is necessary, it should be performed by qualified service personnel. For information on where to reach technical service please see the manual cover. **FOR PERSONAL SAFETY, ALWAYS DISCONNECT THE POWER BEFORE SERVICING.**

TEMPERATURE

Temperature too high

- 1/ controller set too high-see section 5.3.
- 2/ controller failed on – call Customer Service.
- 3/ wiring error – call Customer Service.

Display reads "HI" or "400"+

probe is unplugged, is broken or wire to sensor is broken – trace wire from display to probe; move wire and watch display to see intermittent problems.

Chamber temperature spikes over set point then settles to set point

recalibrate – see section 5.4.

Temperature too low

- 1/ Overtemperature too low – see section 5.5.
- 2/ controller set too low – see section 6.3.
- 3/ unit not recovered from door opening – wait for display to stop changing.
- 4/ unit not recovered from power failure or being turned off – incubators will need 24 hours to warm up and stabilize.
- 5/ element failure – see if HEATING light is on; compare current draw to data plate.
- 6/ controller failure – confirm with front panel lights that controller is calling for heat.
- 7/ Thermostat failure – confirm with front panel lights that Overtemperature is operating correctly.
- 8/ wiring problem – check all functions and compare wiring to diagram in section 9.0, especially around any areas recently worked on.
- 9/ loose connection – check shadow box for loose connections.

Display reads "LO"

- 1/ sensor is plugged in backwards – reverse sensor wires to controller.
- 2/ if ambient room temperature is lower than range of unit – compare set points and ambient temperature to rated specifications in section 9.0.

Unit will not heat over a temperature that is below set point

- 1/ confirm that fan is moving and that amperage and voltage match data plate – check fan motor motion in shadow box and feel for air movement in chamber.
- 2/ confirm that set point is set high enough, turn Overtemperature counterclockwise and see if HEATING light or OVERTEMP light come on.
- 3/ check connections to sensor.
- 4/ check calibration – using independent certified reference thermometer, follow instructions in sections 5.4.

Unit will not heat up at all

- 1/ verify that controller is asking for heat by looking for HEATING light – if pilot light is not on continuously during initial start up there is a problem with the controller.
- 2/ check amperage – amperage should be virtually at maximum rated (data plate) amperage.
- 3/ do all controller functions work?
- 4/ is the Overtemperature Thermostat set high enough? – for diagnostics, should be fully clockwise with the pilot light never on.
- 5/ has the fuse/circuit breaker blown?

Indicated chamber temperature unstable

- 1/ ± 0.1 may be normal.
- 2/ is fan working? – remove top panel and verify movement of cooling fan in center of shadow box.
- 3/ is ambient room temperature radically changing – either door opening or room airflow from heaters or air conditioning? – stabilize ambient conditions.
- 4/ sensor miss-located, damaged, or wires may be damaged – check mounts for Main controller and Thermostat sensors, then trace wires between sensors and controls.
- 5/ calibration sensitivity – call Customer Service.
- 6/ Overtemperature set too low – be sure that set point is more than 5 degrees over desired Main set point; check if pilot light is on continuously; turn controller knob completely clockwise to see if problem solved then follow instructions in section 5.5 for correct setting.
- 7/ electrical noise – remove nearby sources of RFI including motors, arcing relays or radio transmitters.
- 8/ bad connection on temperature sensor or faulty sensor – check connectors for continuity and mechanical soundness while watching display for erratic behavior; check sensor and wiring for mechanical damage.
- 9/ bad connections or faulty capacitor – check connectors for mechanical soundness and look for corrosion around terminals or signs of arcing or other visible deterioration.

Will not maintain set point

- 1/ assure that set point is at least 5 degrees over ambient room temperature.
- 2/ see if ambient is fluctuating; if so, stabilize

Display and reference thermometer don't match

- 1/ calibration error – see section 5.4.
- 2/ temperature sensor failure – evaluate if pilot light is operating correctly.
- 3/ controller failure – evaluate if pilot light is operating correctly
- 4/ allow at least 24 hours to stabilize.
- 5/ verify that reference thermometer is certified.

Can't adjust set points or calibration

- 1/ turn entire unit off and on to reset.
- 2/ if repeatedly happens, call Customer Service.

Calibrated at one temperature, but not at another

This can be a normal condition when operating temperature varies widely. For maximum accuracy, calibration should be done at or as close to the set point temperature.

CO2 LEVEL

Overshoots set point but stabilizes

- 1/ change flow meter up and down to see if solenoid valve works by feeling and listening to valve.
- 2/ recalibrate with Fyrite, see section 5.9 and section 6.0.
- 3/ fan not operating correctly:
 - a- fan motor stopped.
 - b- fan blade fell off.
 - c- wrong fan blade installed or mounted backwards.
- 4/ wrong restrictor installed or missing altogether.
- 5/ tank pressure too high, see section 5.6
- 6/ CO2 sensor partially plugged with dirt or condensation.
- 7/ regulator set wrong, see section 5.6
- 8/ incubator too heavily loaded.
- 9/ incubator being operated without shelving.
- 10/ CO2 attached to sample port instead of "CO2 IN" fitting.

Overshoots set point and continues to rise

- 1/ debris in solenoid causing it to leak continuously.
- 2/ solenoid failed while open.
- 3/ flow meter failure.

Rises very slowly

- 1/ restrictor partially plugged.
- 2/ filter overly dirty or partially plugged.
- 3/ CO2 tank regulator set too low, see section 5.6
- 4/ hose kinked or leaking.
- 5/ poor door seal.
- 6/ CO2 tank contains mixed gas, not 100% medical grade CO2.

Never rises

- 1/ CO2 tank empty.
- 2/ solenoid failed while closed.
- 3/ Flow meter at zero or not set high enough.
- 4/ restrictor plugged.
- 5/ CO2 hose blockage.
- 6/ CO2 filter plugged.

Is unstable

- 1/ confirm that fan is working.
- 2/ check for air leak
- 3/ door not sealing properly.
- 4/ atmospheric pressure fluctuations.
- 5/ defective Fyrite pump or tubing.
- 6/ CO2 entering chamber too quickly:
 - a- tank pressure too high.
 - b- regulator set wrong.
 - c- restrictor incorrect or missing.
- 7/ top of unit exposed to cold air drafts.
- 8/ incubator too heavily loaded.

Feeding continuously or abnormally high CO2 usage

- 1/ do decay test: if more than 1% decay in an hour, check for leak : door gasket tightness, sensor and probe inlet to chamber.
- 2/ check solenoid valve for correct operation.
- 3/ leak in plumbing including between regulator and CO2 tank.
- 4/ door being opened too often.

Won't hold calibration – Fyrite reading varies

- 1/ atmospheric pressure fluctuations.
- 2/ top of unit exposed to cold air drafts.
- 3/ taking Fyrite reading too soon after the door has been opened.

MECHANICAL

Door not sealing

- 1/ check physical condition of gasket.
- 2/ confirm that door latch pulls door in tightly.
- 3/ assure that gasket is in original location.

Motor doesn't move

- 1/ if shaft spins freely: check connections to motor and check voltage to motor;
- 2/ if shaft rubs or is frozen, relieve binding and retest

Motor makes noise

- 1/ If noise is from the motor, tap the top of motor shaft with ball peen hammer.
- 2/ If the sound gets worse, tap the other end of the shaft - avoiding touching the fan blade.
- 3/ If there is no change, call Customer Service.
- 4/ If noise is from shaft or fan blade, realign shaft.

Solenoid valve buzzing

After removing solenoid clean with alcohol for carbon build-up then blow out. Check valve seat or channels for contamination. Check CO2 filter and/or grade of CO2 used. If seat is worn, replace.

OTHER

Controller on at all times - "locked-up"

	<ol style="list-style-type: none"> 1/ turn unit off and on to reset. 2/ if cannot change any condition on the front panel, call Customer Service.
Front panel displays are all off	1/ Check for wire damage.
Unit or wall fuse/circuit breaker is blown	<ol style="list-style-type: none"> 1/ check wall power source. 2/ compare current draw and compare to specs on data plate. 3/ see what other loads are on the wall circuit.
Unit will not turn on	<ol style="list-style-type: none"> 1/ check wall power source. 2/ check fuse/circuit breaker on unit or in wall. 3/ see if unit is on, e.g., fan or heater, and just controller is off. 4/ check all wiring connections, esp. around the on/off switch.
Unit is smoking – Out of box	This can be a common experience as the elements burn off the protective coatings. Put unit under vent and run at full power for one hour until the smoke disipates.
Contamination in chamber	<ol style="list-style-type: none"> 1/ see cleaning procedure in Maintenance section 7.0 2/ develop and follow Standard operating procedure for specific application; include definition of cleaning technique and maintenance schedule.

PARTS LIST

Description	115V	220V
Blower Motor	210002	210001
Chamber Gasket, 7 feet	3450534	3450534
CO2 Filter	100199	100199
CO2 Pressure Regulator	310014	310014
Door Heater	100019	100019
Element	890081	X1000510
EMI Filter (CE Units)	NA	2800502
Fuse, 6.3 amp 250v	103555	103555
Glass Door Assembly	9520572	9520572
Main Temperature Controller w/ Sensing Probe	1750549	1750550
On/Off Switch	103351	103351
Overtemperature Thermostat	10000J	10000J
Pilot Light, Green	200021	200021
Pilot Light, Red	200020	200020
Potentiometer	X1000699	X1000699
Power Cord	104189	104192
Purge Timer	X1000698	103033
Push Button Switch, Purge	103032	103032
Shelf	5120502	5120502
Shelf Clip	200137	200137
Solenoid Valve	8600528	8600529

UNIT SPECIFICATIONS

Weight	Shipping	Net
5015	195 lbs.	134 lbs.
5025	400 lbs.	268 lbs.

Dimensions	Exterior WxDxH (in.)	Interior WxDxH (in.)
5015	25.75 x 28.5 x 37	18 x 20 x 25.25
5025	25.75 x 28.5 x 73.5	*18 x 20 x 25.25

Capacity	Cubic Feet
5015	6
5025	*6

Temperature	Range	Control	Uniformity	CO2 Range
5015	5° above amb. to 70°C	±0.1°C	±0.25° @ 37°C	0-20%
5025	5° above amb. to 70°C	±0.1°C	±0.25° @ 37°C	0-20%

* each chamber

WIRE DIAGRAM

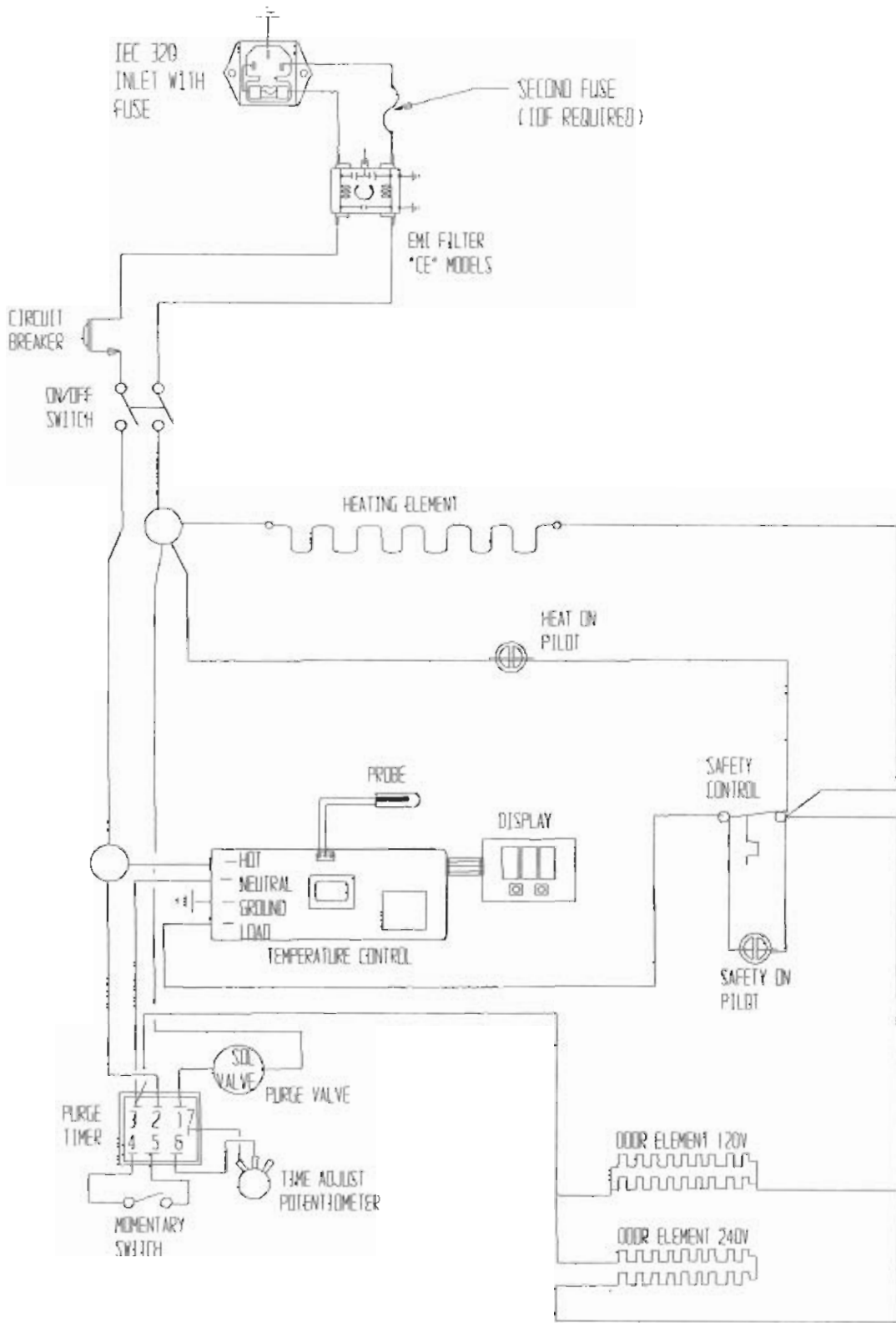

NOTE: MODEL 5025 HAS A REPEAT CIRCUIT EXCEPT FOR POWER CORD

Order From VWR
Call 800-932-5000

from anywhere in the U.S. and Canada

Sales & Inventory Locations:

Pacific Northwest Area

Anchorage, AK
Salt Lake City, UT
San Francisco, CA
Seattle, WA
Tualatin, OR

Midwest Area

Chicago, IL
Detroit, MI
Indianapolis, IN
Minneapolis, MN
St. Louis, MO

Northeast Area

Boston, MA
Cincinnati, OH
Cleveland, OH
Pittsburgh, PA
Rochester, NY

Southeast Area

Atlanta, GA
Oak Ridge, TN

Southwest Area

Albuquerque, NM
Denver, CO
Phoenix, AZ
San Diego, CA
San Dimas, CA

Gulf Area

Austin, TX
Dallas, TX
Houston, TX
Lake Charles, LA

Mid-Atlantic Area

Baltimore, MD
Branford, CT
Bridgeport, NJ
S. Plainfield, NJ

VWR Canlab

Offices
Mississauga, Ontario
Ville Mont-Royal,
Québec
Edmonton, Alberta

Or Call Direct for Specialized Service Locations:

VWR International

3000 Hadley Rd
S. Plainfield, NJ 07080
(908) 757-4045
fax: (908) 757-0313

Puerto Rico

Carr. #869 Km. 1.5 M4
Royal Industrial Park
Catano, PR 00962
(787) 788-3222
fax: (787) 78804320

Switzerland

Ruchligstrasse # 20
P.O. Box 464
Dietikon, Switzerland
CH-8953
011-41-1-745-1155
fax: 011-41-1-745-1150

VWR Direct

911 Commerce Ct.
Buffalo Grove, IL 60089
(800) 444-0880

VWR Furniture Division

P.O. Box 3405
Irving, TX 75015
(972) 714-0336

VWR National Accounts

1310 Goshen Pkwy
W. Chester, PA 19380
(610) 431-1700



Visit Our Web Site at

<http://www.vwrsp.com>

F:\manuals\vwr back sheet.doc

**SHELDON MANUFACTURING, INC.
LIMITED WARRANTY**

Sheldon Manufacturing, Inc., ("Manufacturer") warrants for the original user of this product in the U.S.A. only that this product (parts only if outside of the U.S.A.) will be free from defects in material and workmanship for a period of one year from the date of delivery of this product to the original user (the "Warranty Period"). During the Warranty Period, Manufacturer, at its election and expense, will repair or replace the product or parts that are proven to Manufacturer's satisfaction to be defective, or, at Manufacturer's option, refund the price or credit (against the price of future purchases of the product) the price of any products that are proven to Manufacturer's satisfaction to be defective. This warranty does not include any labor charges if outside of the U.S.A. This warranty does not cover any damage due to accident, misuse, negligence, or abnormal use. Use of Manufacturer's product in a system that includes components not manufactured by Manufacturer is not covered by this warranty. This warranty is void in the event that repairs are made by anyone other than Manufacturer without prior authorization from Manufacturer. Any alteration or removal of the serial number on Manufacturer's products will void this warranty. **Under no circumstances will Manufacturer be liable for indirect, incidental, consequential, or special damages.** The terms of this warranty are governed by the laws of the state of Oregon without regards to the principles of conflicts of laws thereof. If any provision of this limited warranty is held to be unenforceable by any court of competent jurisdiction, the remainder of this limited warranty will remain in full force and effect.

This warranty is in lieu of and excludes all other warranties or obligations, either express or implied. Manufacturer expressly disclaims all implied warranties, including without limitation, the warranties of merchantability and fitness for a particular purpose.

For fast and efficient support, please have the following information available anytime you request service:

Model _____

Serial No. _____

Part No. _____



Artisan Technology Group is your source for quality new and certified-used/pre-owned equipment

- FAST SHIPPING AND DELIVERY
- TENS OF THOUSANDS OF IN-STOCK ITEMS
- EQUIPMENT DEMOS
- HUNDREDS OF MANUFACTURERS SUPPORTED
- LEASING/MONTHLY RENTALS
- ITAR CERTIFIED SECURE ASSET SOLUTIONS

SERVICE CENTER REPAIRS

Experienced engineers and technicians on staff at our full-service, in-house repair center

*InstraView*SM REMOTE INSPECTION

Remotely inspect equipment before purchasing with our interactive website at www.instraview.com ↗

WE BUY USED EQUIPMENT

Sell your excess, underutilized, and idle used equipment. We also offer credit for buy-backs and trade-ins. www.artisanng.com/WeBuyEquipment ↗

LOOKING FOR MORE INFORMATION?

Visit us on the web at www.artisanng.com ↗ for more information on price quotations, drivers, technical specifications, manuals, and documentation

Contact us: (888) 88-SOURCE | sales@artisanng.com | www.artisanng.com