



Artisan Technology Group is your source for quality new and certified-used/pre-owned equipment

- FAST SHIPPING AND DELIVERY
- TENS OF THOUSANDS OF IN-STOCK ITEMS
- EQUIPMENT DEMOS
- HUNDREDS OF MANUFACTURERS SUPPORTED
- LEASING/MONTHLY RENTALS
- ITAR CERTIFIED SECURE ASSET SOLUTIONS

SERVICE CENTER REPAIRS

Experienced engineers and technicians on staff at our full-service, in-house repair center

*InstraView*SM REMOTE INSPECTION

Remotely inspect equipment before purchasing with our interactive website at www.instraview.com ↗

WE BUY USED EQUIPMENT

Sell your excess, underutilized, and idle used equipment. We also offer credit for buy-backs and trade-ins. www.artisanng.com/WeBuyEquipment ↗

LOOKING FOR MORE INFORMATION?

Visit us on the web at www.artisanng.com ↗ for more information on price quotations, drivers, technical specifications, manuals, and documentation

Contact us: (888) 88-SOURCE | sales@artisanng.com | www.artisanng.com

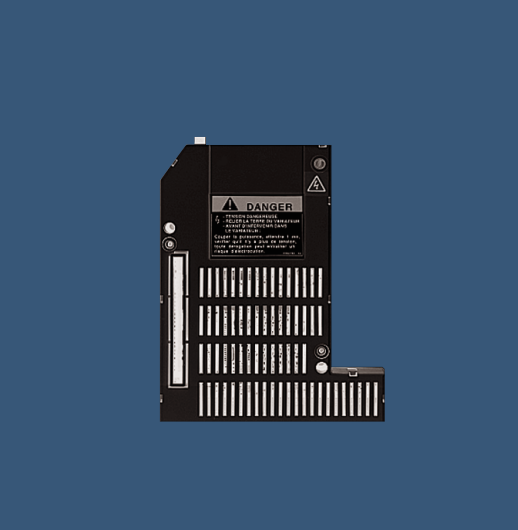

ALTIVAR[®] 16

Additif cartes extension
d'entrées/sorties

I/O extension cards option

Optionskarte E/A-Erweiterung

Aditivo tarjeta de extensión
de entradas/salidas

VW3-A66201 VW3-A66202

Guide d'exploitation

User's manual

Bedienungsanleitung

Guía de explotación



SQUARE D

Additif cartes extension d'entrées/sorties

Page 2

I/O extension cards option

Page 28

Optionskarte E/A - Erweiterung

Seite 54

Aditivo tarjeta de extensión de entradas/salidas

Página 80

F
R
A
N
Ç
A
I
S

E
N
G
L
I
S
H

D
E
U
T
S
C
H

E
S
P
A
Ñ
O
L



Read this document carefully to achieve optimum performance from the speed controller and its option.

The brief descriptions and simplified diagrams are intended for experienced personnel.

It is important to note that altering the adjustments or configurations of the speed controller's parameters will affect its functions and performance. It is therefore advisable to check that these changes do not expose personnel or the plant to any risk.

In local control mode, check that the starting and stopping of the machines is not dangerous in relation to their environment.

Although every care has been taken in the preparation of this document, Schneider Electric SA cannot guarantee the contents and cannot be held responsible for any errors it may contain or for any damage which may result from its use or application.

The hardware, software and services described in this document may be changed or modified at any time, either from a technical point of view or in the way they are operated. Their description can in no way be considered contractual.

Preliminary checks	30
Introduction	31
Access to terminal blocks	32-33
VW3-A66201 card : terminal blocks and connection diagrams	34-35
VW3-A66202 card : terminal blocks and connection diagrams	36-37
Connecting the reference inputs	38
Presentation of the functions	39
Principle of access to the menus	40
<hr/>	
Total unlock	
<hr/>	
Application functions	41
 Preset speeds	42
 Speed reference, tachogenerator feedback	43
 Orient	44-45
 Motor select switch	45
 Process cycles	46-47
Control parameters : voltage reduction	48-49
Output assignment	50-51
Fault management	52



Preliminary checks

Receipt

Ensure that the card reference printed on the label is the same as that on the delivery note corresponding to the purchase order.

Remove the packaging and check that the option card has not been damaged in transit.

Installing the card in the speed controller

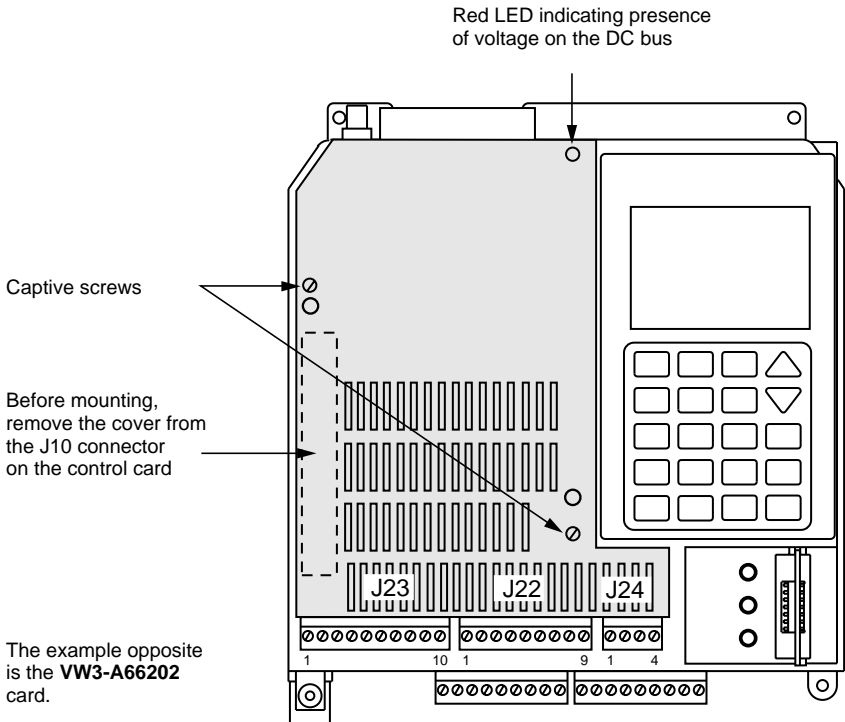

Mounting precautions

Ensure that both the power section and control section on the speed controller are switched off. To access the slot for mounting the extension card, unlock the protective cover and pivot it from right to left.

Check that there is no voltage on the DC bus : red LED off.

Remove the IP20 protective cover from the J10 connector on the control card.

Mount the option card on the control card by plugging it into the J10 terminal block, and fix it using two captive screws.



Introduction

There are two versions of the I/O extension card :

- Card reference **VW3-A66201**, with $\overline{\text{---}}$ 24 V logic inputs.

This comprises : 4 logic inputs
2 analog inputs
2 logic relay outputs
1 analog output

- Card reference **VW3-A66202**, with \sim 115 V logic inputs.

This comprises : 8 logic inputs
2 analog inputs
2 logic relay outputs
1 analog output

The 4 additional logic inputs replace inputs LI1 to LI4 on the speed controller.

On the J12 terminal block on the speed controller:

- inputs LI2, LI3, LI4 are deactivated,
- input LI1 must be connected to +24 ([see diagram on page 37](#)).

Both these cards have a slot at the top left designed to receive a PCMCIA card for connecting the speed controller to a fieldbus.

IP 20 degree of protection.

All the environmental characteristics are the same as for the Altivar 66 (see the catalogue or [the speed controller user's manual](#)).



Access to terminal blocks (sizes 1 to 5)

To access the terminal blocks on the extension card, unlock the protective cover and pivot it from right to left.

Location of the extension card

Sizes 1 to 3

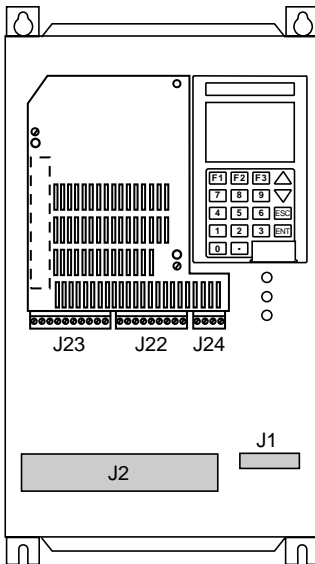

Sizes 4 and 5

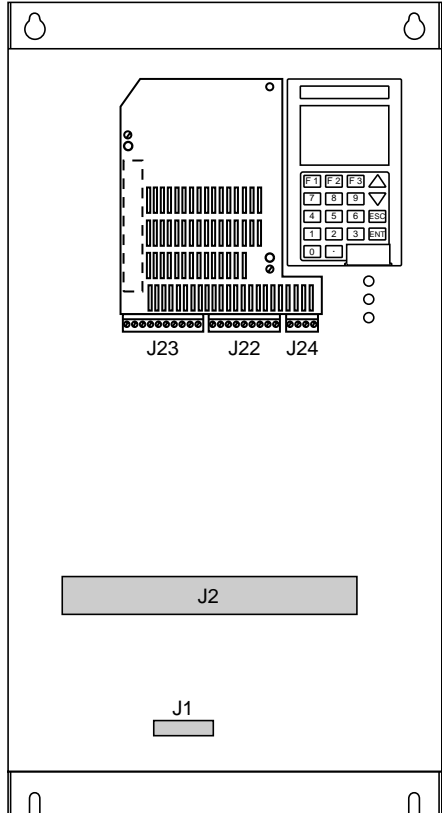

The connection cables enter through the base of the Altivar :

– sizes 1 to 3 : via holes which are fitted with cable glands in the insulating plate (attached with 2 screws), or via the opening created by the removal of this plate.

– sizes 4 and 5 : via holes which are fitted with cable glands in the metal plate, or via the opening created by the removal of this plate.



Access to terminal blocks (size 6)

To access the terminal blocks on the extension card, unlock the protective cover and pivot it from right to left.

Location of the extension card

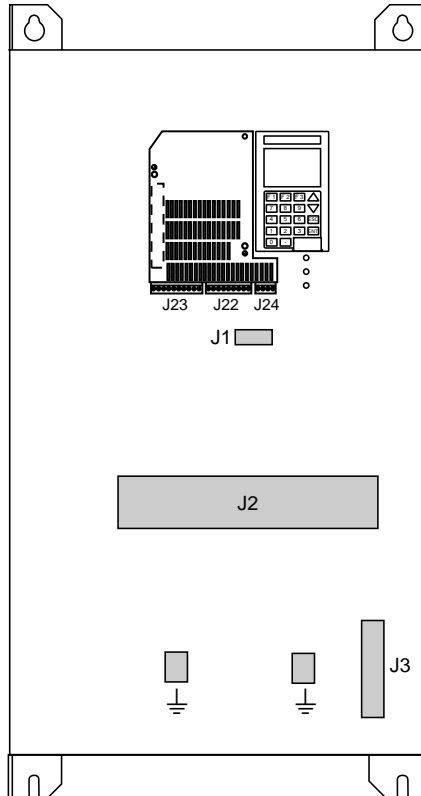

The connection cables enter through the base of the Altivar via holes in the metal plate, or via the opening created by the removal of this plate.

Inside the speed controller, there is a vertical cable duct on the righthand side for the control circuit wiring.



Connection terminal blocks

VW3-A66201 I/O extension card

Terminal blocks J22, J23 and J24 are fitted with removable connectors.
Maximum connection capacity : 2.5 mm², with or without cable end.

Factory configuration of the speed controller

J23-terminals	Function	Characteristics
S	Connection of screening to reference circuits	Earth (ground) terminal connected to Altivar earth
	Terminal not connected	
COM	Analog I/O common	0 V
AI3A	Differential input	± 10 V, impedance 30 kΩ
AI3B	Differential input	
+10	Analog input supply	Maximum current 10 mA
-10	Analog input supply	Maximum current 10 mA
AI4	Current analog input	0-20 mA, 4-20 mA, 20-4 mA, impedance 250 Ω
AO3	Reading the motor power	0/4-20 mA, maximum load impedance 500 Ω
COM	Analog I/O common	0 V

J22-terminals	Function	Characteristics
LI5	7 preset speeds	4 logic inputs, impedance 3.5 kΩ + 24 V supply (min. 11 V, max. 30 V) State 0 if < 5 V, state 1 if ≥ 11 V
LI6	7 preset speeds	
LI7	7 preset speeds	
LI8	Fault reset	
+24 (1)	Logic input supply	+ 24 V (min. 20 V, max. 30 V), maximum current 200 mA

(1) The maximum current of 200 mA corresponds to the consumption at +24 of the control card and at +24 of the extension card.

J24-terminals	Function	Characteristics
R3A R3C	N/O contact on relay R3 : thermal state of motor 100 %	Minimum switching capacity : 10 mA for --- 24 V Maximum switching capacity for inductive load (cos φ = 0.4 and L/R = 7 ms) : 1.5 A for ~ 250 V or 2.5 A for --- 30 V
R4A R4C	N/O contact on relay R4 : speed controller ready	



Connection diagrams

VW3-A66201 I/O extension card

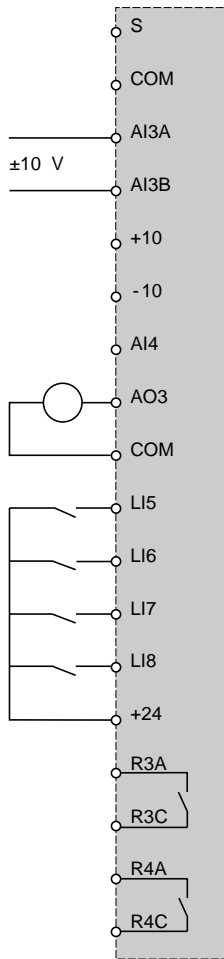

Wiring precautions

Separate the control circuits and the power cables.

For the speed reference circuits, it is advisable to use a twisted cable with a pitch of between 25 and 50 mm, or a screened cable with the screening connected to the S terminal.



Connection terminal blocks

VW3-A66202 I/O extension card

Terminal blocks J22, J23 and J24 are fitted with removable connectors.
Maximum connection capacity : 2.5 mm², with or without cable end.

Factory configuration of the speed controller

J23-terminals	Function	Characteristics
S reference circuits	Connection of screening to Altivar earth	Earth (ground) terminal connected to
	Terminal not connected	
COM	Analog I/O common	0 V
AI3A	Differential input	± 10 V, impedance 30 kΩ
AI3B	Differential input	
+10	Analog input supply	Maximum current 10 mA
-10	Analog input supply	Maximum current 10 mA
AI4	Current analog input	0-20 mA, 4-20 mA, 20-4 mA, impedance 250 Ω
AO3	Reading the motor power	0/4-20 mA, maximum load impedance 500 Ω
COM	Analog I/O common	0 V

J22-terminals	Function	Characteristics
LI1	Unlock the speed controller	8 logic inputs, impedance 30 kΩ ~ 115 V supply (max. ~ 140 V) State 0 if < ~ 30 V, state 1 if > ~ 80 V
LI2	Forward operation command	
LI3	Reverse operation command	
LI4	Step by step (JOG) operation	
LI5	7 preset speeds	
LI6	7 preset speeds	
LI7	7 preset speeds	
LI8	Fault reset	
L2	Analog input supply common	~ 115 V

J24-terminals	Function	Characteristics
R3A R3C	N/O contact on relay R3 : thermal state of motor 100 %	Minimum switching capacity : 10 mA for --- 24 V Maximum switching capacity for inductive load (cos φ = 0.4 and L/R = 7 ms) : 1.5 A for ~ 250 V or 2.5 A for --- 30 V
R4A R4C	N/O contact on relay R4 : speed controller ready	



Connection diagrams

VW3-A66202 I/O extension card

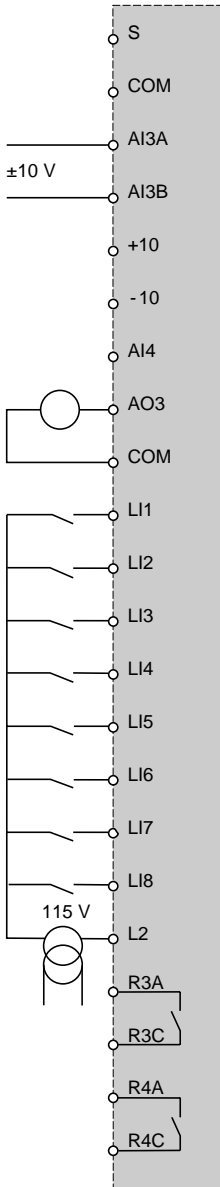

The use of this card requires a connection between the LI1 and +24 terminals on the speed controller. The other inputs, LI2 to LI4, are deactivated.

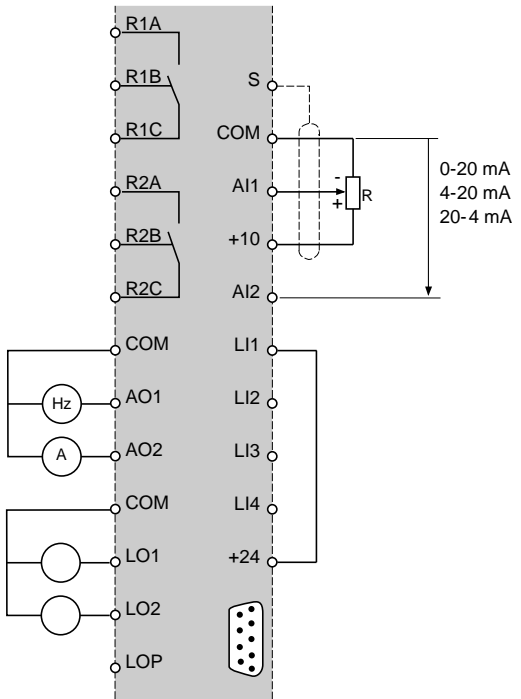

Wiring precautions

These are the same as for the **VW3-A66201** card.



Connecting the reference inputs

I/O extension cards

Bipolar speed reference

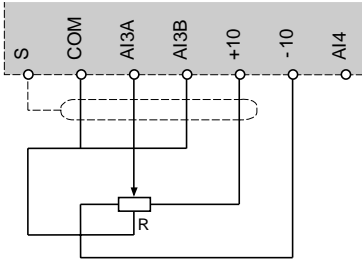

Bipolar speed reference with ± 10 V external power supply

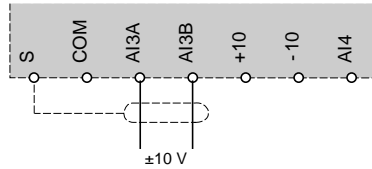

Unipolar speed reference

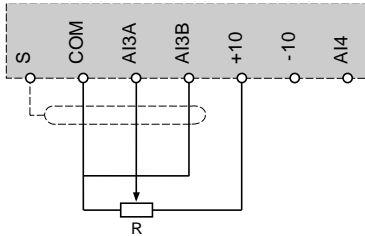

Current speed reference

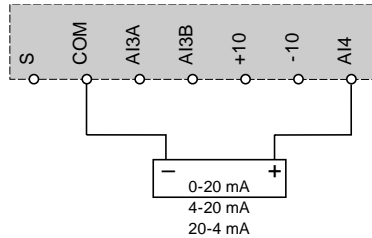

Speed control with tachogenerator feedback

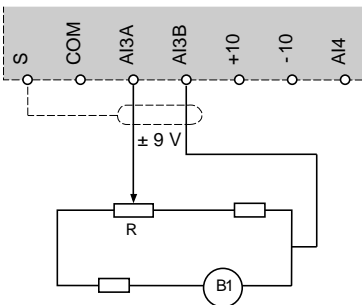

The impedance at the tachogenerator terminals must allow a current of between 20 and 25 mA.



Presentation of the functions

The option is used to extend certain functions and access additional functions.

Extending functions :

- 7 preset speeds.
- Switching between 3 motors.
- Bipolar speed reference.

Additional functions :

- Orient (position of the motor shaft).
- Process cycles.
- Reduction of motor voltage.
- Speed control with tachogenerator feedback.

Application functions incompatibility table

	Orient	Process cycles	Controlled stop	+ speed / - speed	Preset speeds
Orient			●		
Process cycles				●	●
Controlled stop	●				
+ speed / - speed		●			●
Preset speeds		●		●	

● indicates any incompatibility.

For the other application functions of the speed controller, see the programming manual.



Principle of access to the menus

To gain a good understanding of accessing the various menus, it is essential to refer to the speed controller programming manual.

With the extension card installed on the speed controller, a message appears on the screen on initial power-up which enables identification of the option.

```
OPT. :VW3A66201 V1.0

INSTALLED.
REMEMBER YOU NEED TO
CONFIGURE THE OPTION
ENT to continue
```

The reference number of the chosen card and its version appear after OPT.

Confirm acknowledgment of the option by pressing ENT.

```
ENT ↓                               ↑ ESC
                               or 20 s

DRIVE IDENTIFICATION
ATV66U41N4 , CT ,V1.1
Power : 2.2kW/ 3HP
In= 5.8A,Imax= 8.0A
SUPPLY : 400-415 V
▼,▲ /ENT to continue
OPT.1:VW3A66201 V1.0
OPT.2:
OPT.3:
```

In the drive identification menu, it is possible to check the reference number and version of the option selected using the ▼▲ keys.

```
FAULT
OPT. :VW3A66201 V1.0
IS NOT RECOGNIZED
OR
HAS BEEN REMOVED
ENT to continue
```

This screen appears on power-up if an option has been removed which was configured during a preceding power-up.

```
ENT ↓                               ↑ ESC
                               or 20 s

TO RESET THE FAULT
YOU NEED TO REINSTALL
OPT.:VW3A66201 V1.0
or initialize drive
to factory settings
ENT to initialize
```

Cut the general power supply to the speed controller before reinstalling the extension card ([see page 30](#)).



Total unlock : application functions

Select the Application functions menu in General configuration mode.

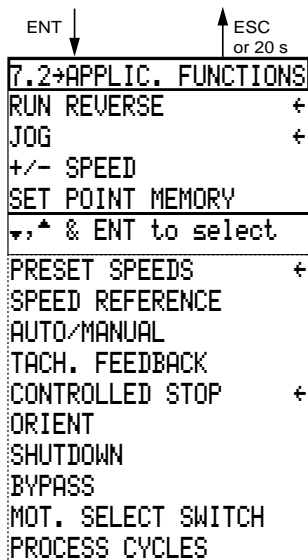

The 4 arrows indicate the factory settings :

- RUN REVERSE (input LI3)
- JOG (input LI4)
- PRESET SPEEDS (inputs LI5, LI6, LI7)
- CONTROLLED STOP (input LI8).

Functions extensions

Application functions available by installing an extension card



Total unlock : application functions

PRESET SPEEDS

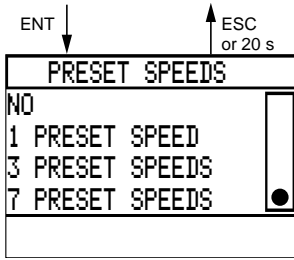

Switching between preset speed references using logic commands.

Selection between 1, 3, or 7 preset speeds.
Factory setting : 7 preset speeds with default assignment of logic inputs LI5, LI6, LI7.
The other possible selections are used to make 1, 2, or 3 logic inputs available so that they can be reassigned to other functions.

Adjustment of preset speeds from 0.1 Hz up to maximum frequency.
Speeds SPEED 1 to SPEED 7 must be in ascending order.

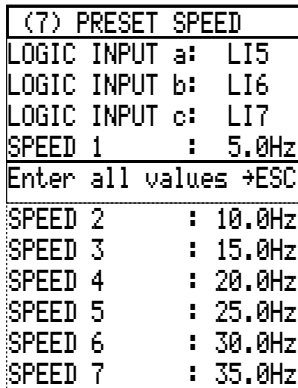

Status table between the logic inputs and the preset speeds.

	LIc	LIb	LIa
Speed reference	0	0	0
SPEED 1	0	0	1
SPEED 2	0	1	0
SPEED 3	0	1	1
SPEED 4	1	0	0
SPEED 5	1	0	1
SPEED 6	1	1	0
SPEED 7	1	1	1

ENGLISH

Example with 8 speeds

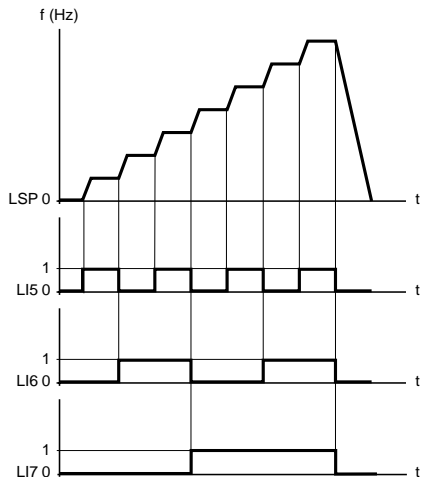



Total unlock : application functions

SPEED REFERENCE

SPEED REFERENCE	
SPEED REF. 1	: AI1
SPEED REF. 2	: AI2
SPEED REF. 3	: ---
CLAMP SUM	: YES
↑,* & ENT to modify	

← ENT →

NO	<input type="checkbox"/>
YES	<input checked="" type="checkbox"/>

The SP.1, SP.2, and SP.3 references are summing, and an analog input must be assigned to each speed reference.

Clamping the sum :

- YES (factory setting) : if AI1 – AI2 is zero or negative, the result is low speed
- NO : if AI1 – AI2 is negative, the direction of rotation is reversed.

AI3 SIGNAL TYPE	
+/- 10 V	<input checked="" type="checkbox"/>
0 ÷ +10 V	<input type="checkbox"/>
0 ÷ -10 V	<input type="checkbox"/>
MULTIPLY BY (-1):	NO
Select and ENT	

← ENT →

NO	<input type="checkbox"/>
YES	<input checked="" type="checkbox"/>

Screens which appear following the procedure for reassigning an analog input ([see page 25 of the programming manual](#)).

AI4 SIGNAL TYPE	
0-20 mA	<input type="checkbox"/>
4-20 mA	<input checked="" type="checkbox"/>
20-4 mA	<input type="checkbox"/>
MULTIPLY BY (-1):	NO
Select and ENT	

← ENT →

NO	<input type="checkbox"/>
YES	<input checked="" type="checkbox"/>

TACHOGENERATOR FEEDBACK

TACH. FBK	
NO	<input checked="" type="checkbox"/>
TACH. FBK.IN: AI3	
-9V=HSP in REV	
0V= 0 speed	
+9V=HSP in FWD	

Possible use of differential input AI3 ([see the connection diagram on page 36](#)).



Total unlock : application functions

ORIENT

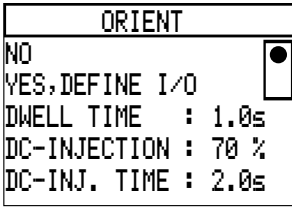

This function enables simple position control to be achieved using an external sensor.

DWELL TIME : adjustable from 0 to 10 s, preset at 1 s.
DC-INJECTION : adjustable from 50 % to 150 % of the nominal motor current, preset at 70 %.
DC-INJ. TIME : adjustable from 0 to 30 s, preset at 2 s.

Example using logic inputs LI5 and LI6, and output R3.

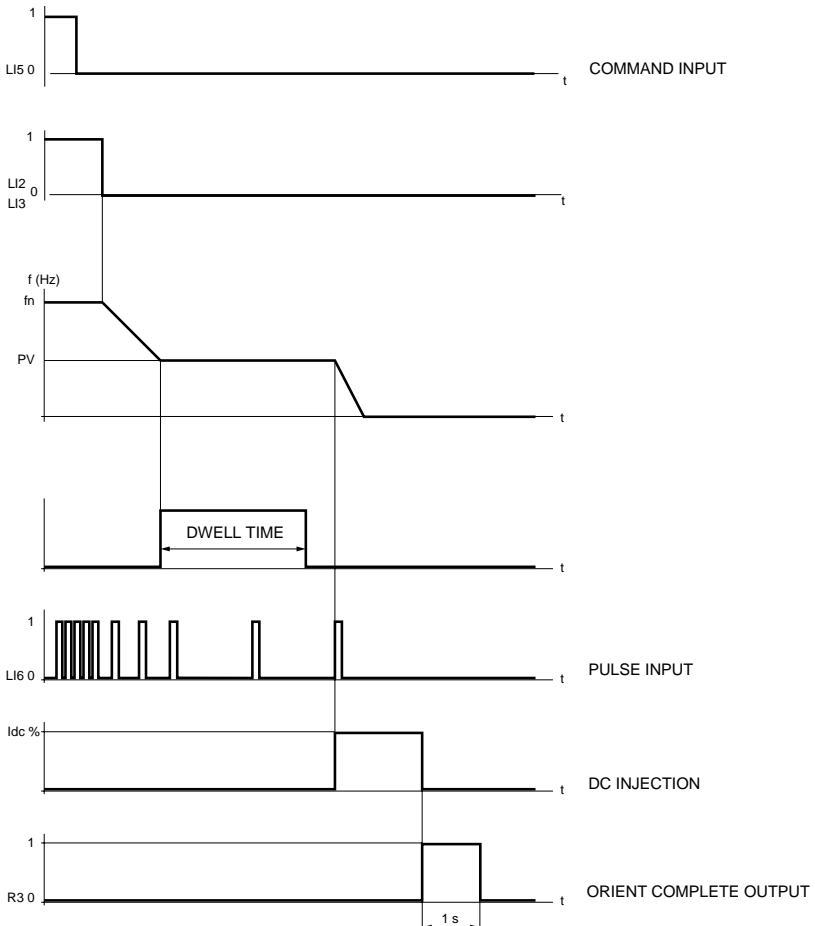

When the ORIENT function is used with a BRAKE SEQUENCE, it is mandatory to adjust $t2 = 0$ and release frequency = PV in the brake sequence.

ENGLISH



Total unlock : application functions

ORIENT I/O	
COMMAND INPUT	:----
PULSE INPUT	:----
COMPLETE OUTPUT	:----
Enter all values +ESC	

Selecting YES and pressing ENT to confirm makes this screen appear which is used to select two logic inputs for the COMMAND INPUT and PULSE INPUT.

To reassign logic inputs, follow the procedure described on page 25 of the programming manual.

Assigning a logic output or a relay output for the COMPLETE OUTPUT is optional.

MOTOR SELECT SWITCH

SWITCH MOT.SEL.	
1 MOTOR	<input checked="" type="radio"/>
2 MOTORS	<input type="radio"/>
2 PARAMETER SETS	<input type="radio"/>
3 MOTORS	<input type="radio"/>
3 PARAMETER SETS	<input type="radio"/>

The speed controller can control three motors of equal or different power in succession.

In this case, select 3 MOTORS and, in the Drive parameters menu set the motor parameters (7.11), the control parameters (7.12), and the control type (7.13) for motor 1. In the same way, use menus (7.14), (7.15) and (7.16) for motor 2, and menus (7.17), (7.18) and (7.19) for motor 3.

Switching between motors must be performed when stopped using an appropriate sequence at the speed controller output.

SWITCH 3 MOTORS			
MOTOR SEL. LIa	:----		
MOTOR SEL. LIb	:----		
	MOT1	MOT2	MOT3
LIa	0	1	0,1
LIb	0	0	1

Another possibility : selecting 3PARAMETERS enables the various control parameters of a single motor to be controlled by a logic command.

In this case, the screen which appears on selection of 3 PARAMETERS is the same as that shown opposite, displayed when 3 MOTORS is selected.

This control can be performed with the motor stopped or running.

Reassign two logic inputs.



Total unlock : application functions

PROCESS CYCLES

```

PROCESS CYCLES
NO
YES
DEFINE I/O
DEFINE STEP :
↓, * & ENT to modify

```

A cycle is made up of up to 8 steps.

A number between 1 and 8 is assigned to DEFINE STEP, indicating the number of the step to be configured or modified.

```

CYCLES I/O
START CYCLE IN :----
RESET CYCLE IN :----
STEP LOCKING IN :----
NEXT STEP IN :----
Enter all values
CYC.COMPLETE OUT:----
CYCLE FAULT OUT:----

```

Definition of the cycle : requires the reassignment of three logic inputs, STEP LOCKING is optional.

Assigning a CYCLE COMPLETE OUTPUT or CYCLE FAULT OUTPUT to an output is optional.

```

CYCLES, STEP Nb.:
FREQUENCY : 30.0Hz
RAMP : 3.0 s
STEP TIME : 30.0 s
NUMBER SUBCYC: 0
DEFINE NEXT STEP
GO TO STEP :

```

The first line indicates the number of the step to be configured.

For each step, define :

- The speed to be reached between 0 and maximum frequency, preset at 30 Hz, as well as the direction of operation.
- The ramp time (acceleration or deceleration) between 0.1 and 999.9 s, preset at 3 s.
- The duration of the step from 0 to 6000 s, preset at 30 s.
- The number of subcycles from 0 to 250 (each subcycle is centred on zero frequency), preset at 0.

```

FREQUENCY :
FWD. (+)
REV. (-)
Hz
ENT

```



Total unlock : application functions

PROCESS CYCLES

Example using logic inputs LI5, LI6, LI7, LI8, and output R3.

Complete cycle

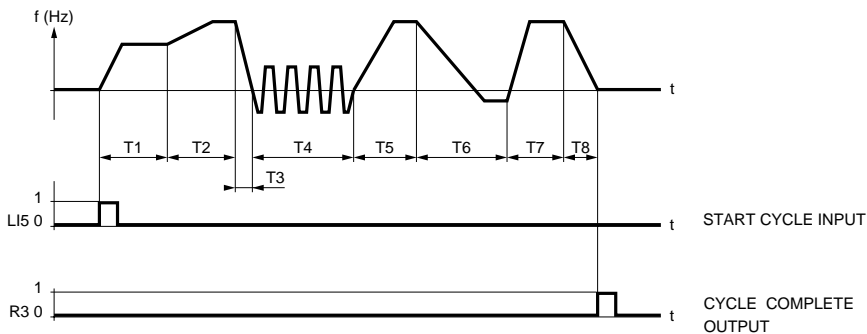

Sequence with modification during the cycle

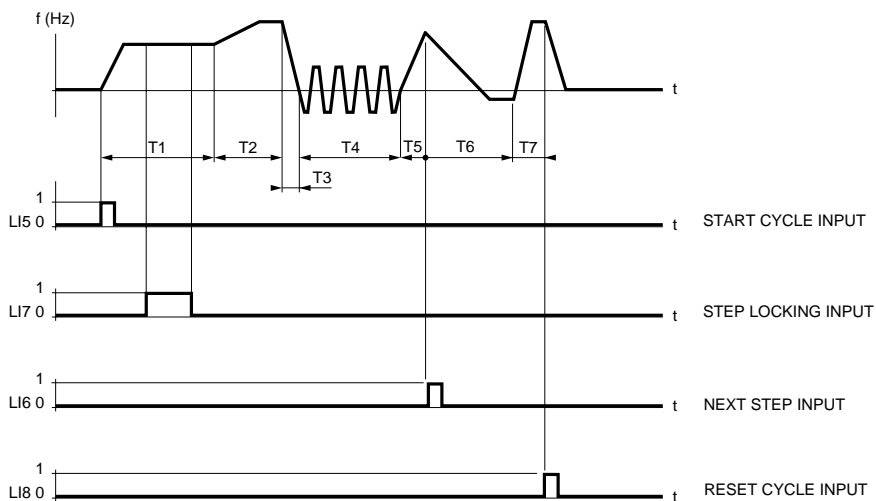



Total unlock : control parameters

VOLTAGE REDUCTION

Select the Control parameters menu from the Drive parameters menu.

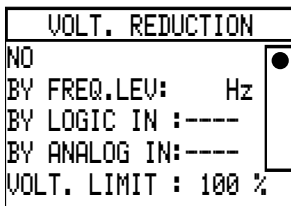
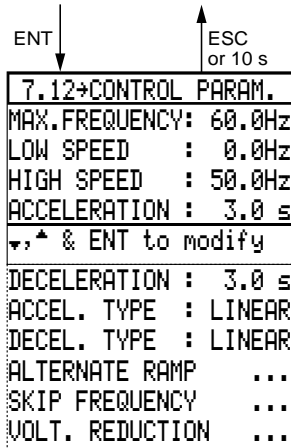

This function is used to reduce the motor voltage in order to limit consumption in case of no load or low load operation.

Confirmation : frequency level or logic or analog input to be reassigned.

FREQ. LEV : adjustable from low speed to high speed, preset at maximum frequency.

VOLT. LIMIT : adjustable from 100 % to 20 %, preset at 100 %.



Total unlock : control parameters

Control via frequency level

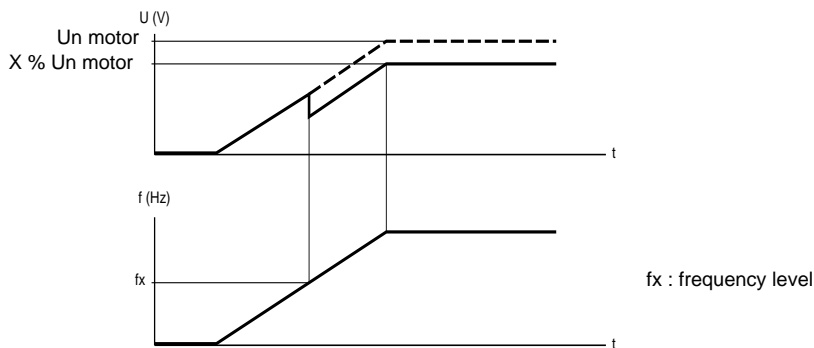

Control via logic input

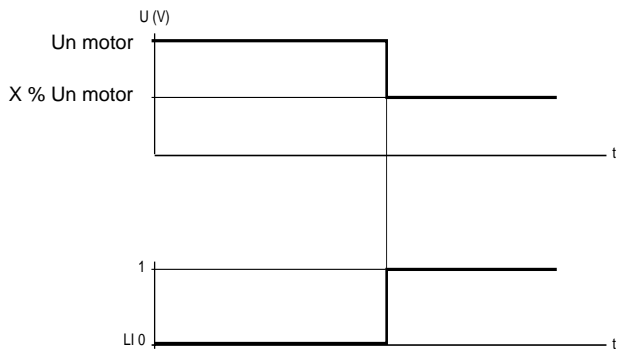

Control via analog input

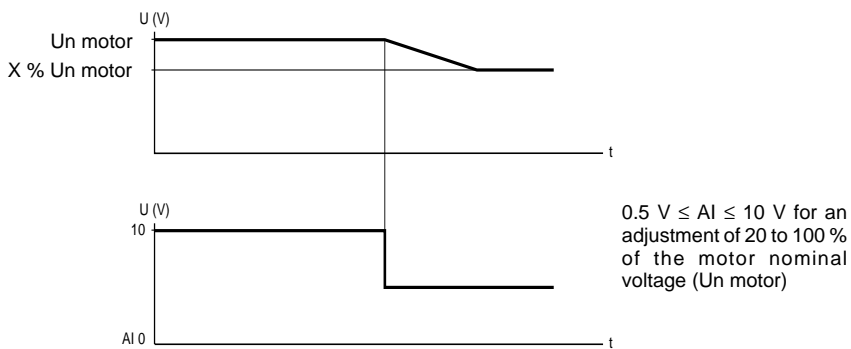



Total unlock : output assignment

Select the Output assignment menu in General configuration mode.

OUTPUT ASSIGNMENT

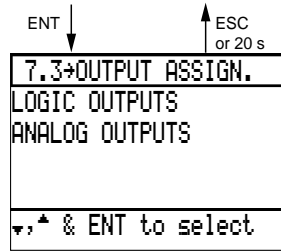

LOGIC OUTPUTS

LOGIC OUT. FUNCTIONS	
READY STATE	←
RUNNING STATE	←
AT SPEED	←
FWD. DIRECTION	
▼, ▲ & ENT to select	
REV. DIRECTION	
TERM./KEYPAD	
AUTO/MANUAL	
CURRENT LIMIT	←
FAULT STATE	←
DRIVE THER.AL.	
LOSS FOLLOWER	
NO RAMP FOLLOW	←
FEEDBACK LOSS	←
OVER SPEED	←
FREQ. LEV.	
FREQ. LEV.2	←
CURRENT LEV.	
CURRENT LEV.2	←
THERMAL LEV.	←
THERMAL LEV.2	←

It is possible to adjust the level for the following functions :

- FREQ. LEV. (Hz), preset at 25 Hz
- FREQ. LEV. 2 (Hz), preset at 0 Hz
- CURRENT LEV. (A), preset at motor nominal current (0.9 times the speed controller nominal current)
- CURRENT LEV. 2 (A), preset at 0.5 motor nominal current
- THERMAL LEV. (%), preset at 100 %, adjustable from 0 to 200 %
- THERMAL LEV. 2 (%), preset at 10 %.

Additional assignments available using an extension card ([see the programming manual](#)).



Total unlock : output assignment

ANALOG OUTPUTS

ANALOG OUT.FUNCTIONS	
MOT. CURRENT	←
MOTOR SPEED	←
MOTOR POWER	←
MOTOR TORQUE	
↓, ↑ & ENT to select	
MOT. VOLTAGE	←
THERM. STATE	←
RAMP OUTPUT	

Additional assignments available using an extension card ([see the programming manual](#)).

Characteristics :

- MOT. CURRENT : 20 mA = 200 % of motor nominal current
- MOTOR SPEED : 20 mA = 100 % of high speed HS, 0 mA = zero speed
- MOTOR POWER : 20 mA = 200 % of motor nominal power to be assigned to the speed controller
in constant torque configuration
- MOTOR TORQUE : 20 mA = 200 % of motor nominal torque
- MOT. VOLTAGE : 20 mA = 110 % of motor nominal voltage
- THERM. STATE : 20 mA = 200 % of motor nominal thermal state
- RAMP OUTPUT : 20 mA = 100 % of high speed HS, 0 mA = zero speed.



Total unlock : fault management

Select the Fault management menu in General configuration mode.

```
7.4→FAULT MANAGEMENT
FAULT STOP : FREEW
POWER LOSS : FREEW
AUTO-RESTART : NO
MOTOR OVERLOAD ...
↓, ↑ & ENT to modify
IN.PHASE FAIL: YES
LOSS FOLLOWER: NO
FOLD BACK : NO
CUSTOM. FAULT: NO
FAULT RESET : NO
DB FAULT : NO
DB RESISTOR PROT ...
OUT.PHASE FLT: YES
```

```
STOP TYPE:
NORMAL
FAST STOP
FREEWHEEL ●
```

```
STOP TYPE
FREEWHEEL ●
RAMP
```

ENT

ENT

ENT

ENT

Assignment of a logic input for a specific fault.
This fault has a stop mode which can be programmed ([see the programming manual](#)).

ENGLISH



GROUPE SCHNEIDER

■ Square D ■ Telemecanique



Artisan Technology Group is your source for quality new and certified-used/pre-owned equipment

- FAST SHIPPING AND DELIVERY
- TENS OF THOUSANDS OF IN-STOCK ITEMS
- EQUIPMENT DEMOS
- HUNDREDS OF MANUFACTURERS SUPPORTED
- LEASING/MONTHLY RENTALS
- ITAR CERTIFIED SECURE ASSET SOLUTIONS

SERVICE CENTER REPAIRS

Experienced engineers and technicians on staff at our full-service, in-house repair center

*InstraView*SM REMOTE INSPECTION

Remotely inspect equipment before purchasing with our interactive website at www.instraview.com ↗

WE BUY USED EQUIPMENT

Sell your excess, underutilized, and idle used equipment. We also offer credit for buy-backs and trade-ins. www.artisanng.com/WeBuyEquipment ↗

LOOKING FOR MORE INFORMATION?

Visit us on the web at www.artisanng.com ↗ for more information on price quotations, drivers, technical specifications, manuals, and documentation

Contact us: (888) 88-SOURCE | sales@artisanng.com | www.artisanng.com