



## Artisan Technology Group is your source for quality new and certified-used/pre-owned equipment

- FAST SHIPPING AND DELIVERY
- TENS OF THOUSANDS OF IN-STOCK ITEMS
- EQUIPMENT DEMOS
- HUNDREDS OF MANUFACTURERS SUPPORTED
- LEASING/MONTHLY RENTALS
- ITAR CERTIFIED SECURE ASSET SOLUTIONS

### SERVICE CENTER REPAIRS

Experienced engineers and technicians on staff at our full-service, in-house repair center

### *InstraView*<sup>SM</sup> REMOTE INSPECTION

Remotely inspect equipment before purchasing with our interactive website at [www.instraview.com](http://www.instraview.com) ↗

### WE BUY USED EQUIPMENT

Sell your excess, underutilized, and idle used equipment. We also offer credit for buy-backs and trade-ins. [www.artisanng.com/WeBuyEquipment](http://www.artisanng.com/WeBuyEquipment) ↗

### LOOKING FOR MORE INFORMATION?

Visit us on the web at [www.artisanng.com](http://www.artisanng.com) ↗ for more information on price quotations, drivers, technical specifications, manuals, and documentation

**Contact us:** (888) 88-SOURCE | [sales@artisanng.com](mailto:sales@artisanng.com) | [www.artisanng.com](http://www.artisanng.com)

# Sun<sup>TM</sup> Ultra<sup>TM</sup> 2 UltraSPARC<sup>TM</sup> -II Module Upgrade

---



THE NETWORK IS THE COMPUTER™

**Sun Microsystems, Inc.**  
901 San Antonio Road  
Palo Alto, CA 94303-4900 USA  
650 960-1300  
Fax 650 969-9131

Part No.: 805-0936-14  
October 1999, Revision A

Send comments about this document to: [docfeedback@sun.com](mailto:docfeedback@sun.com)

Copyright 1999 Sun Microsystems, Inc., 901 San Antonio Road, Palo Alto, California 94303-4900 U.S.A. All rights reserved.

This product or document is protected by copyright and distributed under licenses restricting its use, copying, distribution, and decompilation. No part of this product or document may be reproduced in any form by any means without prior written authorization of Sun and its licensors, if any.

Portions of this product may be derived from the UNIX® system, licensed from Novell, Inc., and from the Berkeley 4.3 BSD system, licensed from the University of California. UNIX is a registered trademark in the United States and in other countries and is exclusively licensed by X/Open Company Ltd. Third-party software, including font technology in this product, is protected by copyright and licensed from Sun's suppliers. RESTRICTED RIGHTS: Use, duplication, or disclosure by the U.S. Government is subject to restrictions of FAR 52.227-14(g)(2)(6/87) and FAR 52.227-19(6/87), or DFAR 252.227-7015(b)(6/95) and DFAR 227.7202-3(a).

Sun, Sun Microsystems, the Sun logo, AnswerBook, SunDocs, Ultra, OpenBoot, UltraSPARC, and Solaris are trademarks or registered trademarks of Sun Microsystems, Inc. in the United States and in other countries. All SPARC trademarks are used under license and are trademarks or registered trademarks of SPARC International, Inc. in the United States and in other countries. Products bearing SPARC trademarks are based upon an architecture developed by Sun Microsystems, Inc.

The OPEN LOOK® and Sun™ Graphical User Interfaces were developed by Sun Microsystems, Inc. for its users and licensees. Sun acknowledges the pioneering efforts of Xerox Corporation in researching and developing the concept of visual or graphical user interfaces for the computer industry. Sun holds a nonexclusive license from Xerox to the Xerox Graphical User Interface, which license also covers Sun's licensees who implement OPEN LOOK GUIs and otherwise comply with Sun's written license agreements.

THIS PUBLICATION IS PROVIDED "AS IS" WITHOUT WARRANTY OF ANY KIND, EITHER EXPRESS OR IMPLIED, INCLUDING, BUT NOT LIMITED TO, THE IMPLIED WARRANTIES OF MERCHANTABILITY, FITNESS FOR A PARTICULAR PURPOSE, OR NON-INFRINGEMENT.

Copyright 1999 Sun Microsystems, Inc., 901 San Antonio Road, Palo Alto, Californie 94303-4900 U.S.A. Tous droits réservés.

Ce produit ou document est protégé par un copyright et distribué avec des licences qui en restreignent l'utilisation, la copie et la décompilation. Aucune partie de ce produit ou de sa documentation associée ne peut être reproduite sous aucune forme, par quelque moyen que ce soit, sans l'autorisation préalable et écrite de Sun et de ses bailleurs de licence, s'il y en a.

Des parties de ce produit pourront être dérivées du système UNIX® licencié par Novell, Inc. et du système Berkeley 4.3 BSD licencié par l'Université de Californie. UNIX est une marque enregistrée aux Etats-Unis et dans d'autres pays, et licenciée exclusivement par X/Open Company Ltd. Le logiciel détenu par des tiers, et qui comprend la technologie relative aux polices de caractères, est protégé par un copyright et licencié par des fournisseurs de Sun.

Sun, Sun Microsystems, le logo Sun, AnswerBook, SunDocs, Ultra, OpenBoot, UltraSPARC, et Solaris sont des marques déposées ou enregistrées de Sun Microsystems, Inc. aux Etats-Unis et dans d'autres pays. Toutes les marques SPARC, utilisées sous licence, sont des marques déposées ou enregistrées de SPARC International, Inc. aux Etats-Unis et dans d'autres pays. Les produits portant les marques SPARC sont basés sur une architecture développée par Sun Microsystems, Inc.

Les utilisateurs d'interfaces graphiques OPEN LOOK® et Sun™ ont été développés de Sun Microsystems, Inc. pour ses utilisateurs et licenciés. Sun reconnaît les efforts de pionniers de Xerox Corporation pour la recherche et le développement du concept des interfaces d'utilisation visuelle ou graphique pour l'industrie de l'informatique. Sun détient une licence non exclusive de Xerox sur l'interface d'utilisation graphique, cette licence couvrant aussi les licenciés de Sun qui mettent en place les utilisateurs d'interfaces graphiques OPEN LOOK et qui en outre se conforment aux licences écrites de Sun.

CETTE PUBLICATION EST FOURNIE "EN L'ETAT" SANS GARANTIE D'AUCUNE SORTE, NI EXPRESSE NI IMPLICITE, Y COMPRIS, ET SANS QUE CETTE LISTE NE SOIT LIMITATIVE, DES GARANTIES CONCERNANT LA VALEUR MARCHANDE, L'APTITUDE DES PRODUITS A REpondre A UNE UTILISATION PARTICULIERE OU LE FAIT QU'ILS NE SOIENT PAS CONTREFAISANTS DE PRODUITS DE TIERS.



# Contents

---

## **Electromagnetic Compatibility v**

- 1. UltraSPARC-II Module Upgrade 1-1**
  - 1.1 System Software Requirements 1-2
    - 1.1.1 Minimum Solaris Operating Environment 1-2
    - 1.1.2 OpenBoot PROM 1-2
  - 1.2 System Hardware Requirements 1-2
  - 1.3 SCD Compliance 1-3
  - 1.4 UltraSPARC-II Module Upgrade Kit 1-3
- 2. Opening the System Unit 2-1**
  - 2.1 Removing Power from the System 2-1
  - 2.2 Removing the System Unit Cover 2-3
  - 2.3 Attaching the Wrist Strap 2-5
- 3. Installing the UltraSPARC-II Module 3-1**
  - 3.1 Updating the Flash PROM 3-1
  - 3.2 Removing the UltraSPARC Module 3-1
  - 3.3 Installing the UltraSPARC-II Module 3-3
  - 3.4 Completing the Installation 3-7
    - 3.4.1 Changing the Clocking Select Jumper 3-7

- 3.4.2 Closing the System Unit 3-9
- 3.4.3 Turning On the Power 3-11
- 3.4.4 Power-On Self-Test (POST) 3-11
- 3.4.5 EnergyStar 3-11
- 3.4.6 Returning the Removed Module(s) 3-12

# Electromagnetic Compatibility

---

---

## FCC Class B Notice — United States

This device complies with Part 15 of the FCC Rules. Operation is subject to the following two conditions:

1. This device may not cause harmful interference.
2. This device must accept any interference received, including interference that may cause operation.

---

**Note** – This equipment has been tested and found to comply with the limits for a Class B digital device, pursuant to Part 15 of the FCC Rules. These limits are designed to provide reasonable protection against harmful interference in a residential installation. This equipment generates, uses and can radiate radio frequency energy and, if not installed and used in accordance with the instructions, may cause harmful interference to radio communications. However, there is no guarantee that interference will not occur in a particular installation. If this equipment does cause harmful interference to radio or television reception, which can be determined by turning the equipment off and on, the user is encouraged to try to correct the interference by one or more of the following measures:

---

- Reorient or relocate the receiving antenna.
- Increase the separation between the equipment and receiver.
- Connect the equipment into an outlet on a circuit different from that to which the receiver is connected.
- Consult the dealer or an experienced radio/television technician for help.

## Shielded Cables

Connections between the workstation and peripherals must be made using shielded cables in order to maintain compliance with FCC radio frequency emission limits.

## Modifications

Modifications to this device that are not approved by the party responsible for compliance may void the authority granted to the user by the FCC to operate this equipment.

---

## DOC Class B Notice — Canada

This digital apparatus does not exceed the Class B limits for radio noise emission for a digital apparatus as set out in the Radio Interference Regulations of the Canadian Department of Communications.

---

## Avis concernant les systèmes appartenant à la classe B du DOC — Canada

Le présent appareil numérique n'émet pas de bruits radioélectriques dépassant les limites applicables aux appareils numériques de la classe B prescrites dans le Règlement sur le brouillage radioélectriques édicté par le Ministère des Communications du Canada.

---

# Nippon — Japan

## VCCI 基準について

### クラス A VCCI 基準について

クラス A VCCI の表示があるワークステーションおよびオプション製品は、クラス A 情報技術装置です。これらの製品には、下記の項目が該当します。

この装置は、情報処理装置等電波障害自主規制協議会 (VCCI) の基準に基づくクラス A 情報技術装置です。この装置を家庭環境で使用すると電波妨害を引き起こすことがあります。この場合には使用者が適切な対策を講ずるよう要求されることがあります。

### クラス B VCCI 基準について

クラス B VCCI の表示  があるワークステーションおよびオプション製品は、クラス B 情報技術装置です。これらの製品には、下記の項目が該当します。

この装置は、情報処理装置等電波障害自主規制協議会 (VCCI) の基準に基づくクラス B 情報技術装置です。この装置は、家庭環境で使用することを目的としていますが、この装置がラジオやテレビジョン受信機に近接して使用されると、受信障害を引き起こすことがあります。取扱説明書に従って正しい取り扱いをしてください。



-viii Sun Ultra 2 UltraSPARC-II Module Upgrade • October 1999

## UltraSPARC-II Module Upgrade

---

This book contains procedures for installing an UltraSPARC™-II module upgrade in a Sun™ Ultra™ 2 system. The Sun Ultra 2 system can now support a 400-Mhz CPU if the motherboard is part number 501-3132-13 or higher.

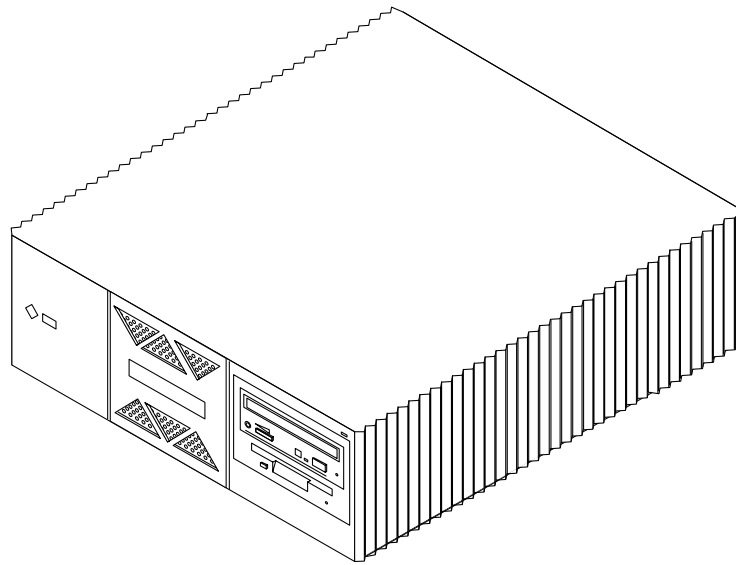

**FIGURE 1-1** Ultra 2 System

---

## 1.1 System Software Requirements

### 1.1.1 Minimum Solaris Operating Environment

TABLE 1-1 Minimum Solaris Operating Environment

CPU Frequency	Solaris Release
167 MHz	2.5.1
200 MHz	2.5.1 Hardware: 4/97
250 MHz	2.5.1 Hardware: 8/97
300 MHz	2.5.1 Hardware: 11/97, 2.6 Hardware: 3/98
400 MHz	2.5.1 Hardware: 11/97, 2.6 Hardware: 5/98, Solaris 7 5/99

### 1.1.2 OpenBoot PROM

UltraSPARC-II systems require OpenBoot PROM version 3.11.2 (or later).

---

## 1.2 System Hardware Requirements

Ultra 2 systems operated in multiprocessor mode must use processor modules of the same clock frequency.

Determine the clock frequency of the processor module(s) already installed in your system.

Query your system by typing:

```
% prtconf -vp | grep banner-name  
    banner-name: `Sun Ultra 2 UPA/SBus (2 X UltraSPARC 168Hz)'
```

The system responds with the quantity (for example, 2 x) and speed (168 MHz) of the UltraSPARC module(s) installed.

---

## 1.3 SCD Compliance

Sun Ultra 2 systems have been independently tested and verified to comply with revision 2.1 of the SPARC Compliance Definition (SCD) developed by SPARC International, Inc. These systems are binary compatible with all other systems and software that conform to SCD version 2.1.



FIGURE 1-2 SCD Compliance

---

## 1.4 UltraSPARC-II Module Upgrade Kit

Each UltraSPARC-II module upgrade kit contains:

- This book
- UltraSPARC-II module
- UPA terminator module (for 300-MHz uniprocessor systems only)
- Antistatic wrist strap
- Flash PROM update CD-ROM and programming guide

---

**Note** – Retain the packing box and shipping material for use in returning the removed module(s).

---

1-4 Sun Ultra 2 UltraSPARC-II Module Upgrade • October 1999

## Opening the System Unit

---

This chapter contains the following sections:

- Section 2.1, “Removing Power from the System,” on page 2-1
- Section 2.2, “Removing the System Unit Cover,” on page 2-3
- Section 2.3, “Attaching the Wrist Strap,” on page 2-5

---

### 2.1 Removing Power from the System

Before turning off system power, shut down the operating system to avoid loss of data.

1. **If your system is not a stand-alone, notify users that the system is going down.**  
Refer to the *Solaris Handbook* for the procedure.
2. **Back up the system files and data.**  
Refer to the *Solaris Handbook* for the procedure.
3. **Shut down the system.**
4. **Turn the power off to the monitor and all peripherals connected to the system.**
5. **Remove DC power from the system by pressing the Standby side of the power switch on the back panel (FIGURE 2-1).**

---

**Note** – After the Standby switch is pressed, it returns to its original position.

---

6. **Verify that when the power is off, the LED on the middle front of the system is not lit and the fans are not running (FIGURE 2-2).**

7. Detach all cords and cables connected to the system unit except for the AC power cord.

---

**Note** – The AC power cord provides the grounding path for safely discharging static electricity. Note where each cord and cable attaches to the system unit.

---



---

**Caution** – When the Power On/Standby switch is pressed and the AC power cord remains connected to a power outlet, hazardous AC voltage is still present in the power supply primary.

---

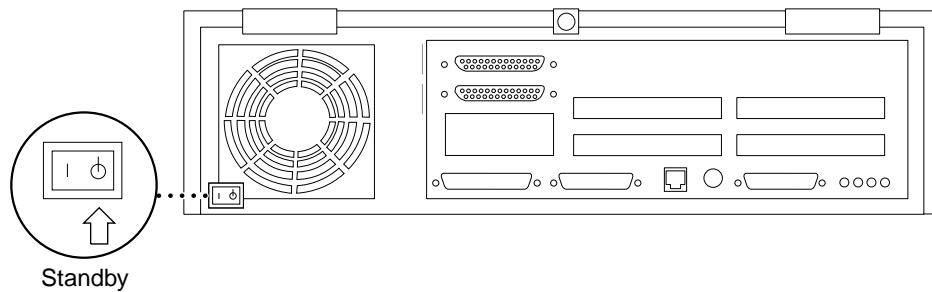

**FIGURE 2-1** Standby Switch

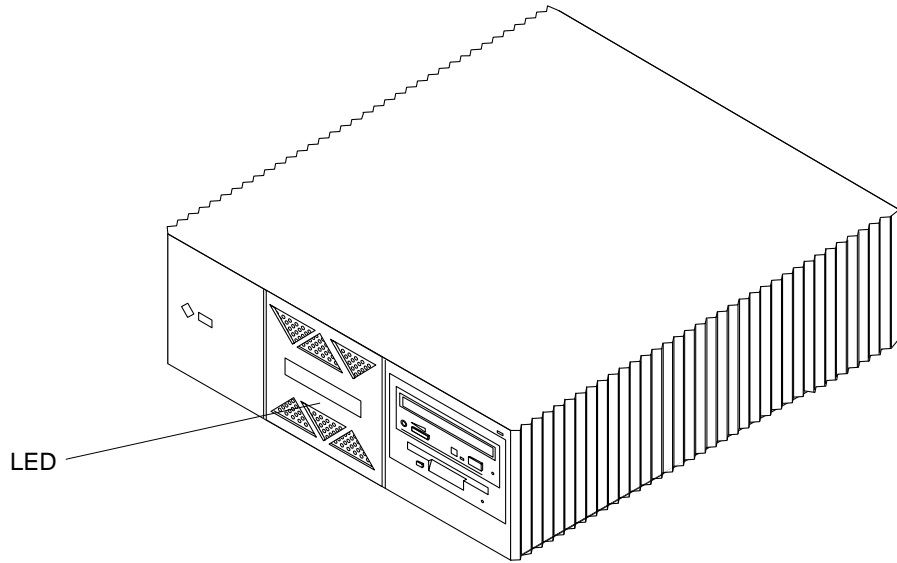

FIGURE 2-2 Front Panel LED Location

---

## 2.2 Removing the System Unit Cover

1. Use a Phillips screwdriver to remove the lock block (if installed) on the top cover and back panel (FIGURE 2-3).
2. Pull the two top cover plastic tabs towards yourself.
3. Lift the top cover so that it clears the chassis, and push the cover forward so that it clears the chassis (FIGURE 2-4).



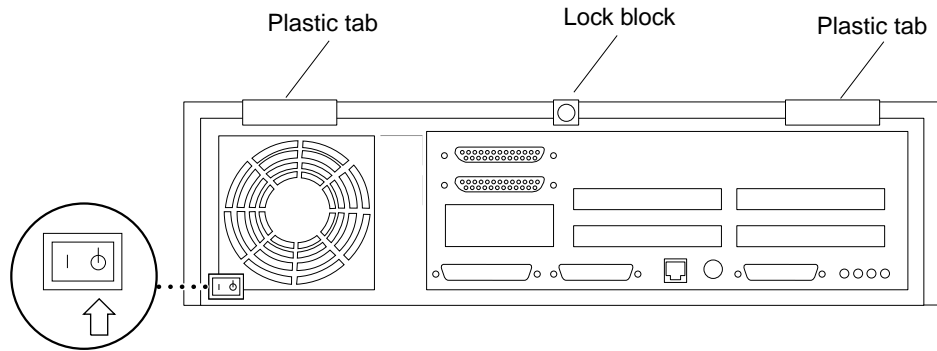

**FIGURE 2-3** Opening the System Unit

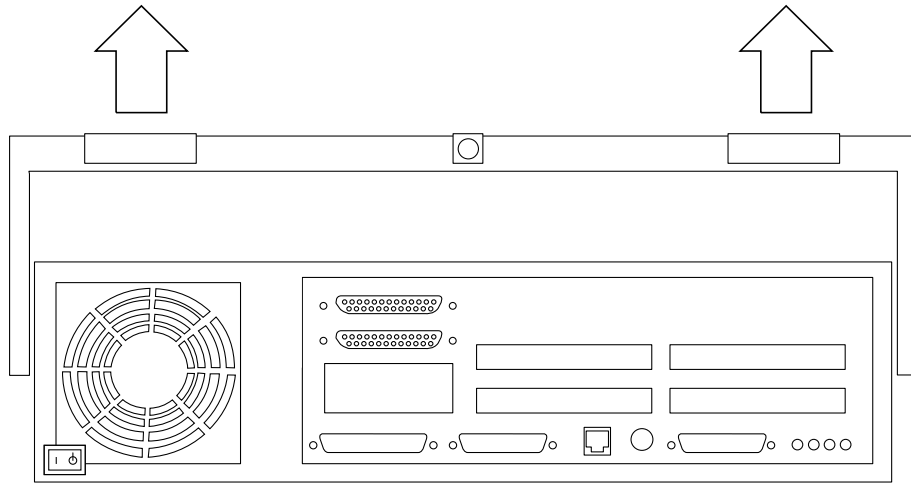

**FIGURE 2-4** Lifting the Top Cover

---

## 2.3 Attaching the Wrist Strap

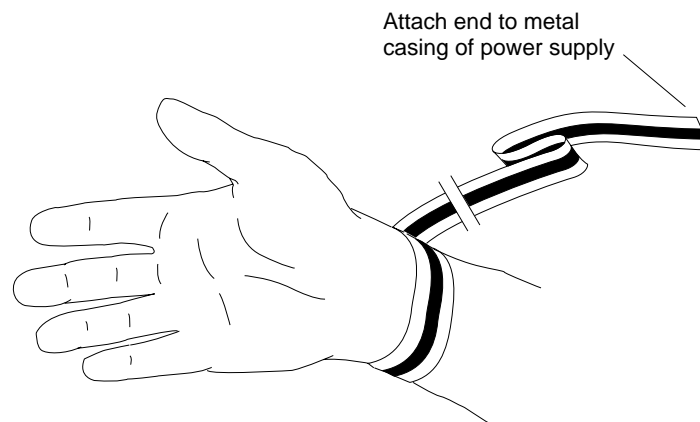

Wrap the wrist strap twice around your wrist (adhesive against your skin).

FIGURE 2-5 Attaching the Wrist Strap

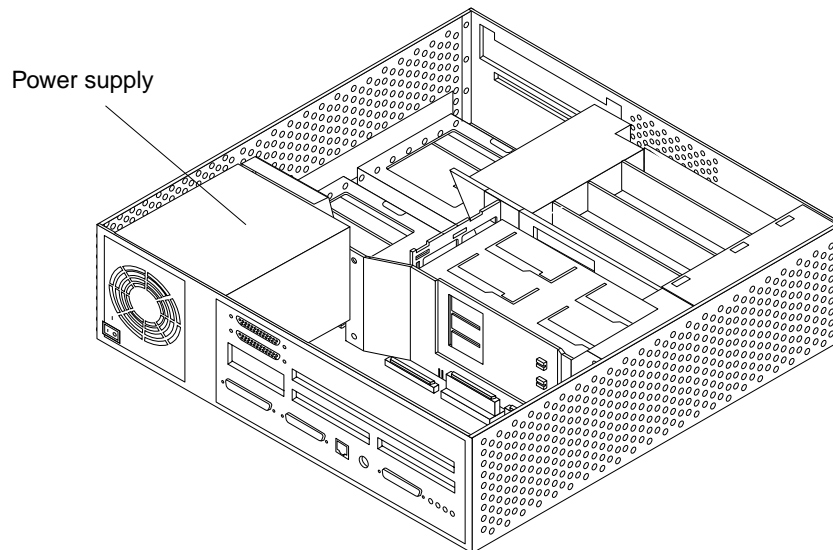

FIGURE 2-6 Power Supply Location

2-6 Sun Ultra 2 UltraSPARC-II Module Upgrade • October 1999

## Installing the UltraSPARC-II Module

---

---

### 3.1 Updating the Flash PROM

Use Sun™ Flash PROM Guide for Workstations and Workgroup Servers - Standalone Version, part number 802-3233, for updating your system's flash PROM.

---

### 3.2 Removing the UltraSPARC Module

The Sun Ultra 2 system can now support a 400-Mhz CPU if the motherboard is part number 501-3132-13 or higher.

---

**Note** – The motherboard part number is located on the right front side of the motherboard. See FIGURE 3-6 on page 8 to locate the motherboard part number stamp.

---

Skip this section and read Section 3.3, “Installing the UltraSPARC-II Module,” on page 3-3.” if your system is already equipped with one UltraSPARC-II module and you are adding a second module of the same clock frequency.

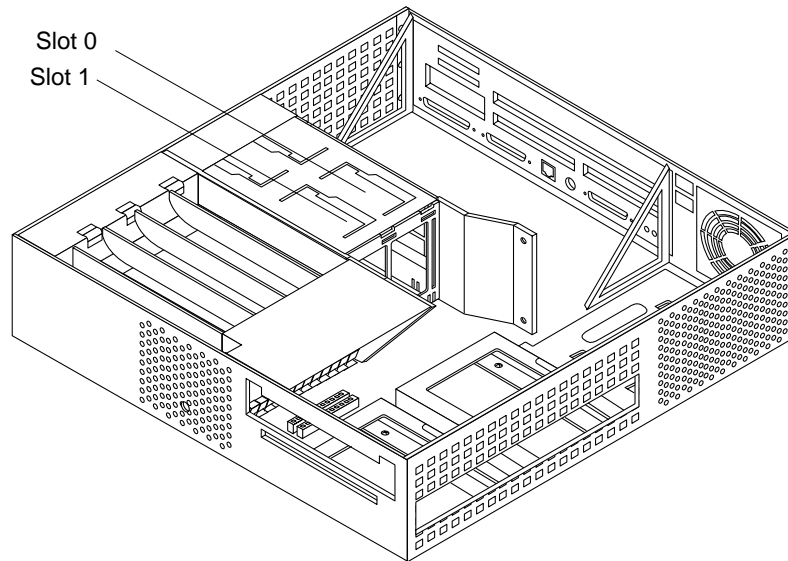

**FIGURE 3-1** UltraSPARC Module Locations and Shroud Assembly Processor Area

- 1. Grip the sides of the shroud-assembly processor area (see FIGURE 3-1).**
- 2. With the thumbs of both hands, simultaneously lift the two levers on the module upwards and to the side—about 135 degrees (FIGURE 3-2).**
- 3. Lift the module upwards until it clears the system chassis.**
- 4. Place the module on an antistatic surface.**

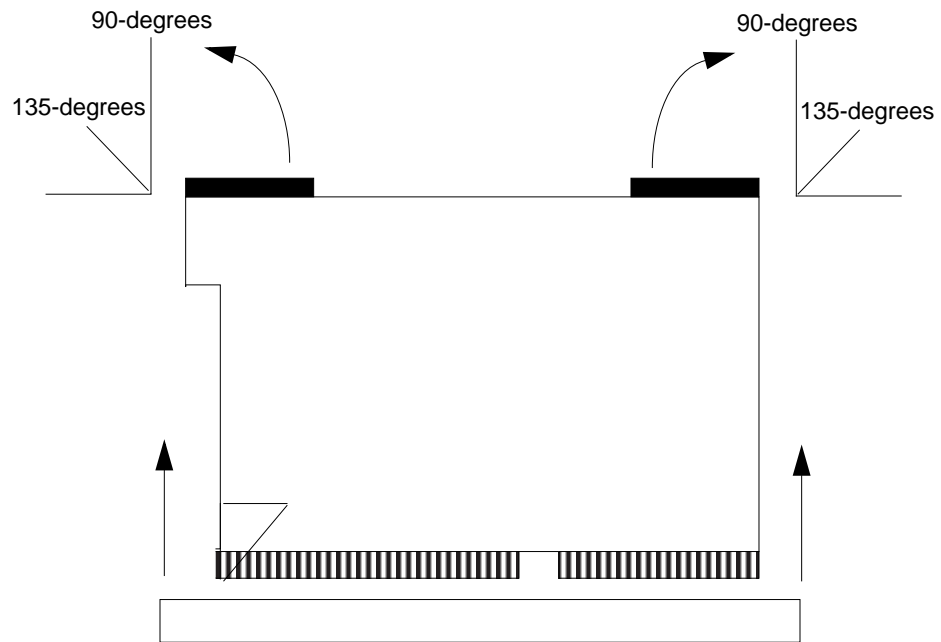

FIGURE 3-2 Removing the UltraSPARC Module

---

## 3.3 Installing the UltraSPARC-II Module



---

**Caution** – All CPUs must have the same clock speed.

---

1. **Unpack the UltraSPARC-II processor module.**
2. **Place the module on an antistatic surface.**
3. **Identify the appropriate or available slot (FIGURE 3-3).**

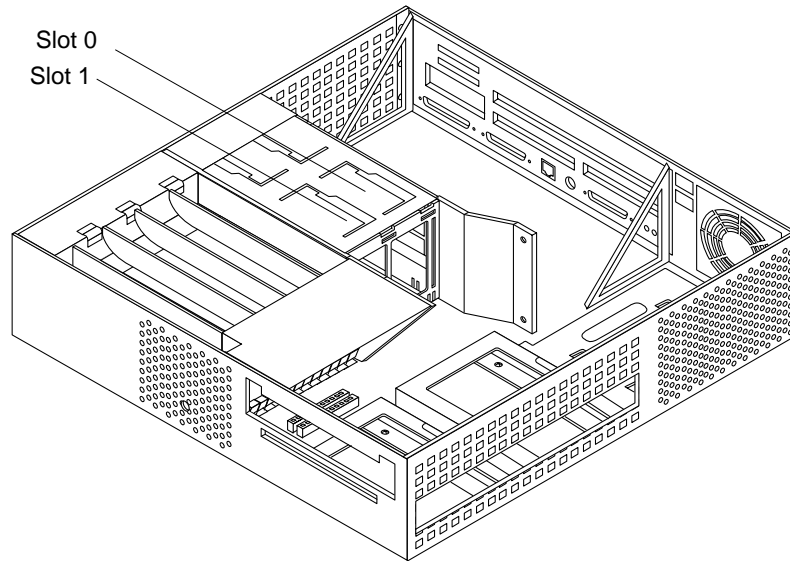

**FIGURE 3-3** Ultra 2 Processor Slot Locations

- If your system is equipped with one UltraSPARC-II module, the module must be installed in slot 0 and a UPA terminator module (501-4843-01) may need to be installed in slot 1. Refer to the following table.

---

**Note** – The motherboard part number is located on the right front side of the motherboard. See FIGURE 3-6 on page 8 to locate the motherboard part number stamp.

---

**TABLE 3-1** UPA Terminator Module Necessity

Motherboard Part Number	167-MHz CPU	200-MHz CPU	250-MHz CPU	300-MHz CPU	400-MHz CPU
501-3132-01 through -08	No	No	No	NS (Not supported)	NS
501-3132-09 through -12	No	No	No	Yes	NS
501-3132-13 or later	No	No	No	No	No

- If your system is equipped with two UltraSPARC-II modules, slot 0 and slot 1 will each have a module installed.

4. On the antistatic surface, hold the module in an upright position so that the plastic surface faces you (FIGURE 3-4).
5. Move the levers on the module to the 135-degree position.
6. Lower the module along the vertical plastic guides until the module touches the slot socket on the main logic board.

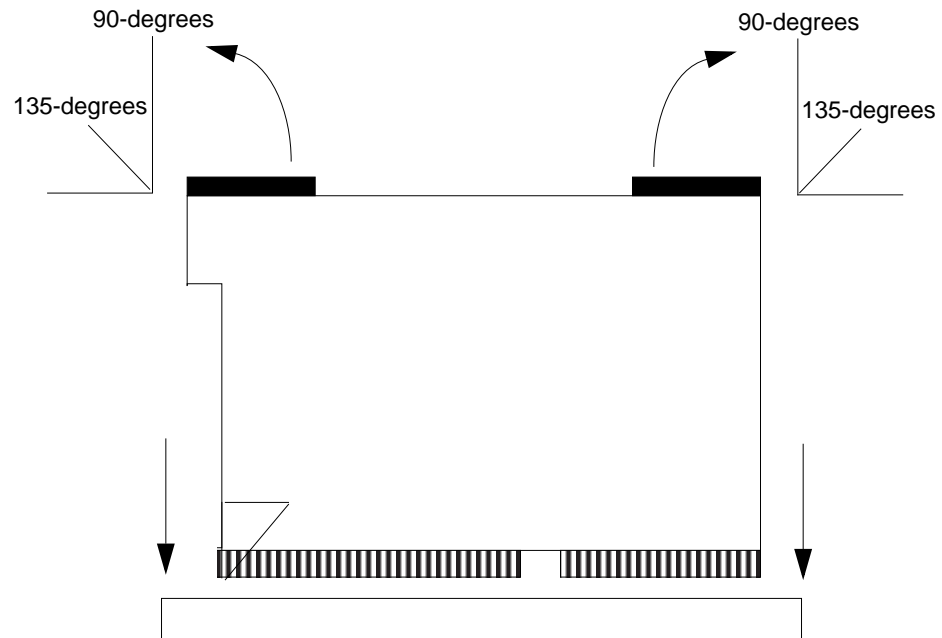
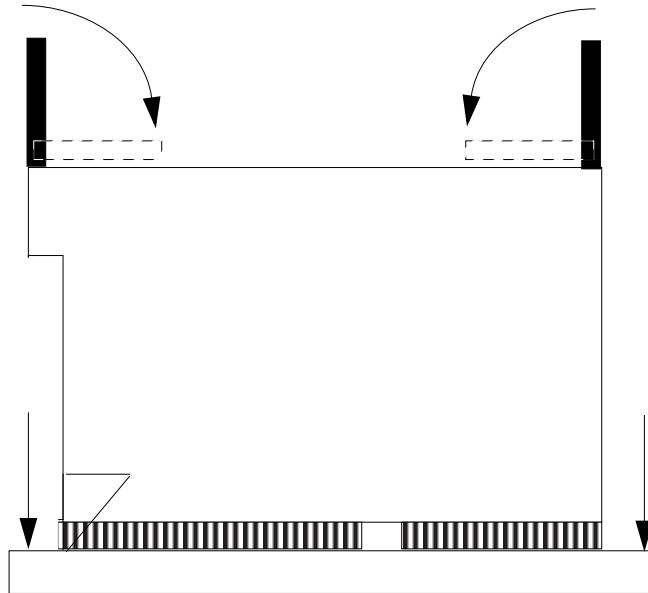

FIGURE 3-4 Lowering the Module Into the Chassis

7. With both hands, simultaneously turn and press the levers downward to the fully horizontal position. Firmly press the module downward into the socket until it is fully seated and the levers are fully locked (FIGURE 3-5).





**FIGURE 3-5** Locking the Module in Place

- 8. If your system has only one UltraSPARC-II module installed in slot 0, follow Steps 5 through 7 of this procedure to install the UPA terminator (501-4843-01) in slot 1 if necessary. Refer to TABLE 3-1 on page 4.**

---

## 3.4 Completing the Installation

### 3.4.1 Changing the Clocking Select Jumper

The following table gives information about the clocking select jumper functionality. The following figures show the location of the clocking select jumper on the main logic board, and the two available jumper settings, respectively.

To change the jumper; use needlenose pliers to remove the jumper from position A and to install the jumper at position B (see FIGURE 3-7).

**TABLE 3-2** UltraSPARC Module Clocking Select Jumper Settings

Jumper	Pins 1 + 2 Select	Pins 2 + 3 Select
J2301	250-MHz or 300-MHz UltraSPARC-II modules.	All UltraSPARC-I 168-MHz or 200-MHz, or 400-MHz UltraSPARC-II module.

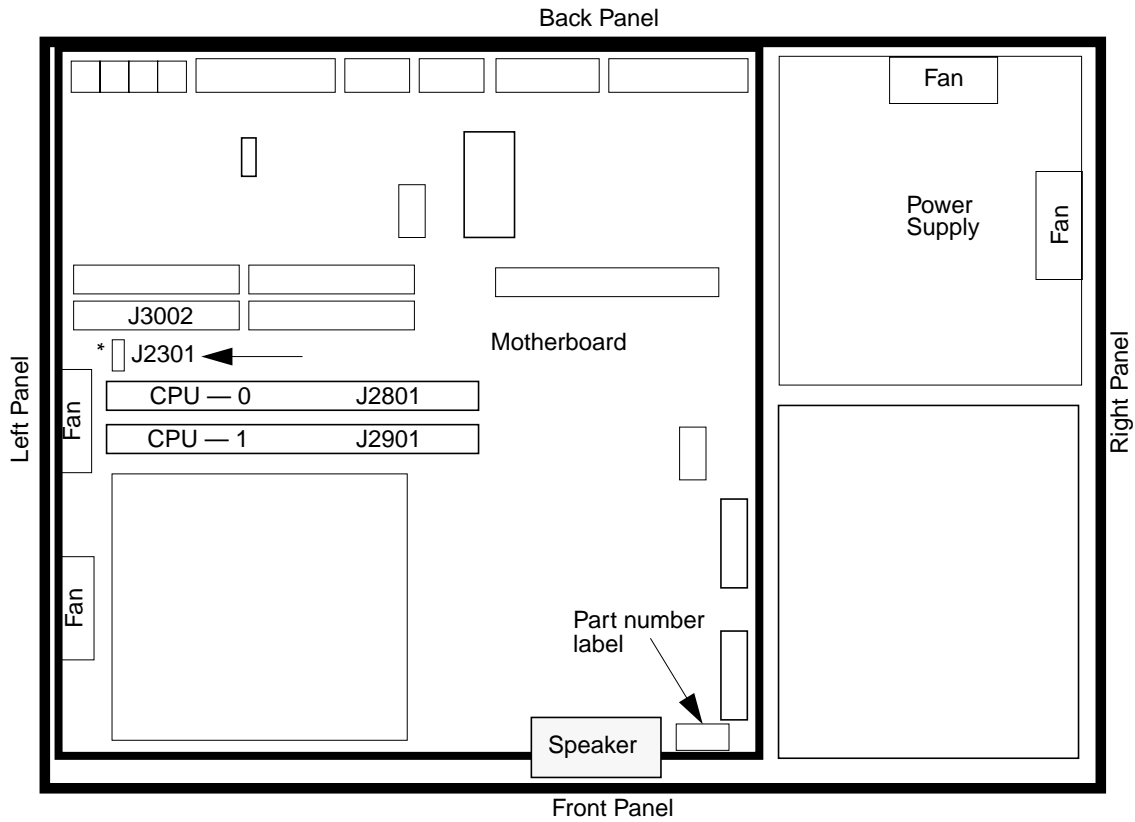

FIGURE 3-6 Clocking Select Jumper Location on Ultra 2 Motherboard

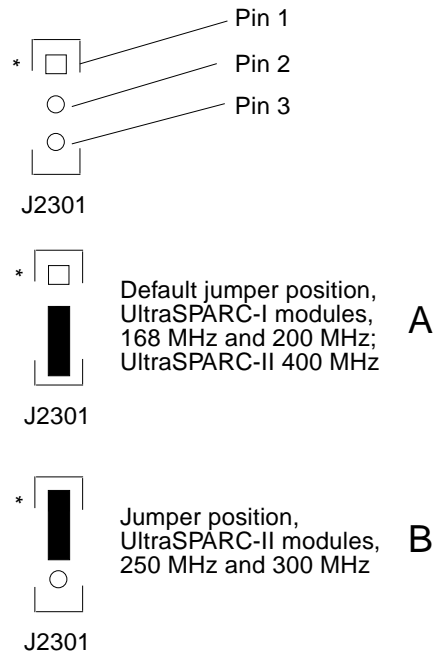
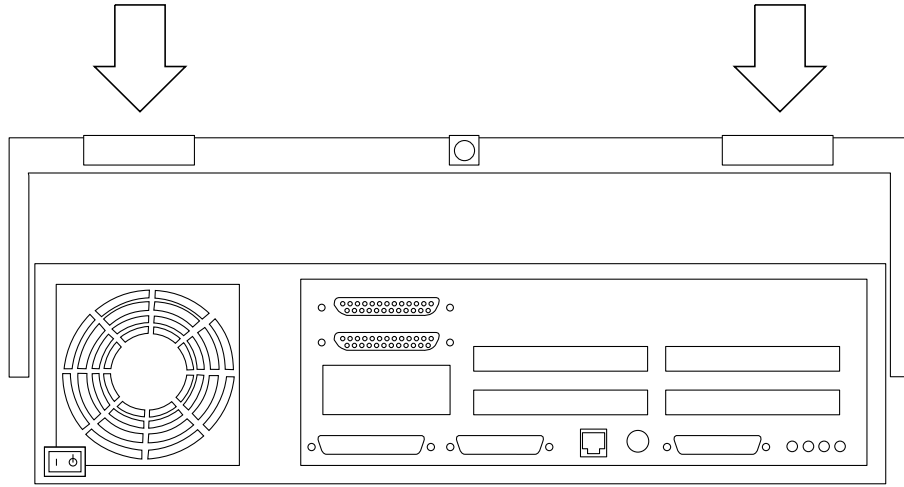

FIGURE 3-7 Clocking Select Jumper Positions

## 3.4.2 Closing the System Unit

1. Remove the wrist strap from your wrist and then from the power supply.
2. Hold the cover at an angle to the system unit. Seat the cover lip to the chassis lip.
3. Slowly lower the cover onto the system unit so that the rear of the cover seats with the chassis back panel (see FIGURE 3-8).



**FIGURE 3-8** Lowering the Cover Onto the System Unit Back Panel

- 4. Guide the two top cover plastic tabs in place onto the back panel.**  
You will hear a click as each tab seats with the back panel (see FIGURE 3-9).
- 5. Use a Phillips screwdriver to reinstall the lock block to the back panel.**

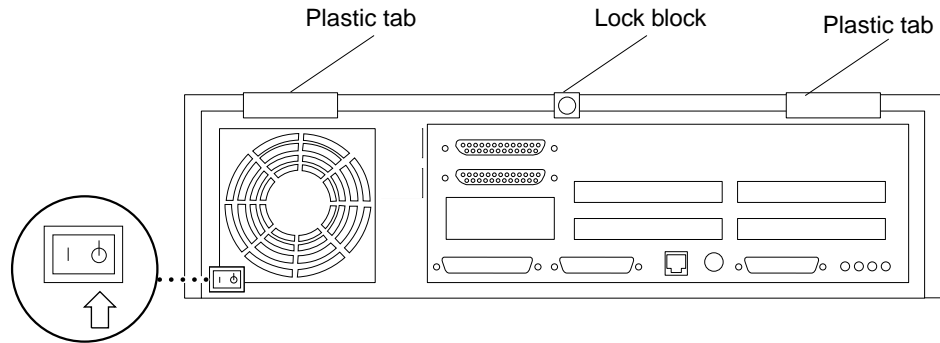

**FIGURE 3-9** Cover Tabs and Lock Block

## 3.4.3 Turning On the Power

1. Reattach all cords and cables connected to the system unit.
2. Turn on the power in this order:
  - External SCSI peripheral with SCSI terminator attached
  - External SCSI peripheral daisy-chained to the SCSI peripheral with the SCSI terminator attached
  - Monitor
  - Power On/Standby switch on the system unit back panel.
3. The operating system should load or the `ok` prompt should appear on the monitor.

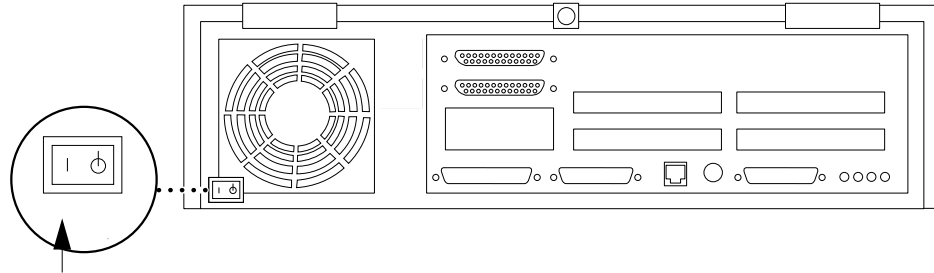

FIGURE 3-10 Power On/Standby Switch

## 3.4.4 Power-On Self-Test (POST)

For a full description of the Power-On Self-Test (POST), refer to the *Sun Ultra 2 Service Manual*.

## 3.4.5 EnergyStar

If you experience RED State Exception failures when exercising EnergyStar suspend/resume functions on Solaris 2.5.1 releases prior to Solaris 2.5.1 HW 4/97, install patch 104729-01.

### 3.4.6 Returning the Removed Module(s)

To return the removed module(s) to Sun Microsystems, Inc., use the shipping box and packing materials for the UltraSPARC module(s) and:

1. **Place the removed module(s) in the antistatic bag(s).**
2. **Fold and tape the end(s) of the bag(s).**
3. **Place the bag(s) and other shipping materials in the shipping box.**
4. **Affix the RMA (Return Material Authorization) label from the upgrade kit onto the shipping carton.**
5. **Return the shipping carton to Sun Microsystems, Inc.**



## Artisan Technology Group is your source for quality new and certified-used/pre-owned equipment

- FAST SHIPPING AND DELIVERY
- TENS OF THOUSANDS OF IN-STOCK ITEMS
- EQUIPMENT DEMOS
- HUNDREDS OF MANUFACTURERS SUPPORTED
- LEASING/MONTHLY RENTALS
- ITAR CERTIFIED SECURE ASSET SOLUTIONS

### SERVICE CENTER REPAIRS

Experienced engineers and technicians on staff at our full-service, in-house repair center

### *InstraView*<sup>SM</sup> REMOTE INSPECTION

Remotely inspect equipment before purchasing with our interactive website at [www.instraview.com](http://www.instraview.com) ↗

### WE BUY USED EQUIPMENT

Sell your excess, underutilized, and idle used equipment. We also offer credit for buy-backs and trade-ins. [www.artisanng.com/WeBuyEquipment](http://www.artisanng.com/WeBuyEquipment) ↗

### LOOKING FOR MORE INFORMATION?

Visit us on the web at [www.artisanng.com](http://www.artisanng.com) ↗ for more information on price quotations, drivers, technical specifications, manuals, and documentation

**Contact us:** (888) 88-SOURCE | [sales@artisanng.com](mailto:sales@artisanng.com) | [www.artisanng.com](http://www.artisanng.com)