



Artisan Technology Group is your source for quality new and certified-used/pre-owned equipment

- FAST SHIPPING AND DELIVERY
- TENS OF THOUSANDS OF IN-STOCK ITEMS
- EQUIPMENT DEMOS
- HUNDREDS OF MANUFACTURERS SUPPORTED
- LEASING/MONTHLY RENTALS
- ITAR CERTIFIED SECURE ASSET SOLUTIONS

SERVICE CENTER REPAIRS

Experienced engineers and technicians on staff at our full-service, in-house repair center

*InstraView*SM REMOTE INSPECTION

Remotely inspect equipment before purchasing with our interactive website at www.instraview.com ↗

WE BUY USED EQUIPMENT

Sell your excess, underutilized, and idle used equipment. We also offer credit for buy-backs and trade-ins. www.artisanng.com/WeBuyEquipment ↗

LOOKING FOR MORE INFORMATION?

Visit us on the web at www.artisanng.com ↗ for more information on price quotations, drivers, technical specifications, manuals, and documentation

Contact us: (888) 88-SOURCE | sales@artisanng.com | www.artisanng.com

Last Revised: 2014-11-06 07:14:41.0

High-Performance NI-XNET Interfaces for CAN, LIN, and FlexRay

NI PCI-851x, NI PXI-851x, NI 986x

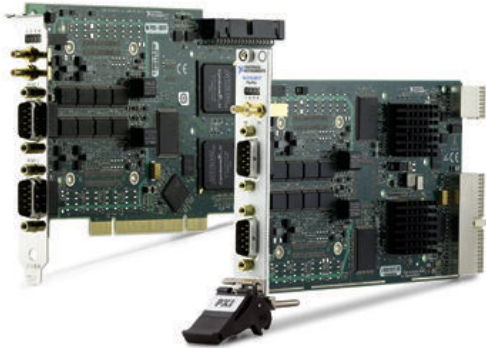

- High-performance CAN, LIN, and FlexRay interfaces with onboard transceivers and software-selectable termination
- NI-XNET driver and API for CAN, LIN, and FlexRay that simplify application development in NI LabVIEW, NI LabWindows™/CVI, and C/C++
- NI-XNET device-driven DMA engine that minimizes message latency and streams full-bandwidth CAN, LIN, and FlexRay bus data
- Integrated signal databases that automatically translate CAN, LIN, and FlexRay frames to engineering-level signals, including FIBEX, CANdb (.DBC), LIN Description File (LDF), and NI-CAN (.NCD)
- Hardware synchronization, 1 μs timestamps for integration with NI data acquisition, digitizers, switches, and large systems
- Integrated, onboard transceivers for simpler setup, better reliability, and no hidden costs
- Dedicated per-port processors that manage up to 192 hardware-accelerated frames, reducing host system load and software complexity
- Bundled software: All NI-XNET interfaces include the NI-XNET driver and API, NI-XNET Bus Monitor, and NI-XNET Database Editor

Overview

The NI-XNET platform combines a series of high-performance CAN, LIN, and FlexRay interfaces with the NI-XNET driver and API—a common set of easy-to-use functions for reading and writing CAN, LIN, and FlexRay frames and signals in user-created applications.

[Back to Top](#)

Requirements and Compatibility

OS Information

- PharLap
- Real-Time OS
- Windows 7
- Windows 7 64-bit
- Windows Vista x64/x86
- Windows XP

Driver Information

- NI-CAN
- NI-XNET

Software Compatibility

- ANSI C/C++
- Borland C++/Builder
- LabVIEW
- LabVIEW Real-Time Module
- LabWindows/CVI

[Back to Top](#)

Application and Technology

Feature Comparison

Model	Bus	Physical Layer	Transceivers	Min Baud Rate	Max Baud Rate	Ext Sync Connector	Ports
PCI							
PCI-8511	CAN	Low-Speed/Fault-Tolerant	TJA1054A	40 kbits/s ^[1]	125 kbits/s	-	1
PCI-8511/2	CAN	Low-Speed/Fault-Tolerant	2 x TJA1054A	40 kbits/s ^[1]	125 kbits/s	-	2
PCI-8512	CAN	High-Speed/FD	TJA1041	40 kbits/s	8 Mbit/s	-	1

PCI-8512/2	CAN	High-Speed/FD	2 x TJA1041	40 kbits/s	8 Mbit/s	-	2
PCI-8513	CAN	Software-Selectable/FD	TJA1054A, TJA1041, AU5790	40 kbits/s ^[1] , 40 kbits/s, 33.3 kbits/s	125 kbits/s, 8 Mbit/s, 83.3 kbits/s	2 x SMB	1
PCI-8513/2	CAN	Software-Selectable/FD	2 x TJA1054A, 2 x TJA1041, 2 x AU5790	40 kbits/s ^[1] , 40 kbits/s, 33.3 kbits/s	125 kbits/s, 8 Mbit/s, 83.3 kbits/s	2 x SMB	2
PCI-8516	LIN	LIN	2 x ATA6620	2400 bits/s	20 kbits/s	-	2
PCI-8517/2	FlexRay	FlexRay	2 x TJA1080	1 Mbit/s	10 Mbits/s	2 x SMB	2
PXI							
PXI-8511	CAN	Low-Speed/Fault-Tolerant	TJA1054A	40 kbits/s ^[1]	125 kbits/s	-	1
PXI-8511/2	CAN	Low-Speed/Fault-Tolerant	2 x TJA1054A	40 kbits/s ^[1]	125 kbits/s	-	2
PXI-8512	CAN	High-Speed/FD	TJA1041	40 kbits/s	8 Mbit/s	-	1
PXI-8512/2	CAN	High-Speed/FD	2 x TJA1041	40 kbits/s	8 Mbit/s	-	2
PXI-8513	CAN	Software-Selectable/FD	TJA1054A, TJA1041, AU5790	40 kbits/s ^[1] , 40 kbits/s, 33.3 kbits/s	125 kbits/s, 8 Mbit/s, 83.3 kbits/s	2 x SMB	1
PXI-8513/2	CAN	Software-Selectable/FD	2 x TJA1054A, 2 x TJA1041, 2 x AU5790	40 kbits/s ^[1] , 40 kbits/s, 33.3 kbits/s	125 kbits/s, 8 Mbit/s, 83.3 kbits/s	2 x SMB	2
PXI-8516	LIN	LIN	2 x ATA6620	2400 bits/s	20 kbits/s	-	2
PXI-8517/2	FlexRay	FlexRay	2 x TJA1080	1 Mbit/s	10 Mbits/s	2 x SMB	2
NI CompactDAQ/NI CompactRIO							
NI 9862	CAN	High-Speed/FD	TJA1041	40 kbits/s	8 Mbit/s	-	1
NI 9861	CAN	Low-Speed/Fault-Tolerant	TJA1054A	40 kbits/s ^[1]	125 kbits/s	-	1
NI 9866	LIN	LIN	NXP TJA1028	2400 bits/s	20 kbits/s	-	1

¹Low-speed CAN transceivers operate down to 10 kbits/s in error conditions.

CAN FD is the next generation of high-speed CAN communication with evolving standards for higher data rates. NI has enabled speeds up to 8 Mbit/s using the TJA1041 and TJA1043 transceivers through the NI-XNET driver. As transceiver vendors complete qualifications for CAN FD speeds, NI will update our documentation as necessary.

NI-XNET High-Performance CAN, LIN, and FlexRay Interfaces

The NI-XNET product line is a combination of accelerated NI-XNET controller area network (CAN), local interconnect network (LIN), and FlexRay interfaces; an optimized driver; easy-to-use APIs; and configuration and debugging utilities. With NI-XNET interfaces, you can develop applications for prototyping, simulating, and testing CAN, LIN, and FlexRay networks faster and more easily in LabVIEW, the LabVIEW Real-Time Module, and C/C++.

NI-XNET interfaces bring together the performance associated with low-level microcontroller programming and the power of Windows and LabVIEW Real-Time OS development. The patent-pending NI-XNET device-driven DMA engine reduces system latency, a common pain point for PC-based CAN, LIN, and FlexRay interfaces, from milliseconds to microseconds. The driver-level signal database engine and bundled NI-XNET utilities reduce time-consuming frame-to-signal translation while maintaining top performance. Support for industry-standard CAN, LIN, and FlexRay signal database formats, including FIBEX, CANdb (.DBC), LDF, and NI-CAN NCD, simplifies NI-XNET integration into embedded network design workflows.

With compatibility for up to 192 hardware-accelerated frames, NI-XNET devices offload repetitive processing from the host system, leaving more CPU time for executing models and performing other tasks. NI-XNET LIN devices also offer hardware-timed scheduling, leaving more CPU time for other tasks. NI RTSI synchronization support enables NI-XNET interfaces to integrate and synchronize with other NI products, including data acquisition, PXI modular instrumentation, vision, and motion.

Applications

- Hardware-in-the-loop simulation
- Rapid control prototyping
- Bus monitoring/replay
- High-throughput bus streaming
- Rest-of-bus simulation
- Automation control
- In-vehicle data logging

One API for Windows and Real-Time OSs

Real-time processing of CAN, LIN, and FlexRay signal and frame data is crucial for accurate hardware-in-the-loop simulation and rapid control prototyping. LabVIEW applications for NI-XNET devices work on both Windows and LabVIEW real-time targets with no code modifications, which simplifies building and maintaining code across platforms. This same code can be reused in many different form factors such as PXI, PCI, NI CompactDAQ, and NI CompactRIO. NI-XNET interfaces are designed to operate in a real-time environment with minimum jitter and maximum performance.

One API for CAN, LIN, and FlexRay

The NI-XNET API is a common set of function calls and operations for the CAN, LIN, and FlexRay networks. Decrease development time and maximize code reuse by working with the same API for many projects involving different networks.

CAN	FlexRay
-----	---------



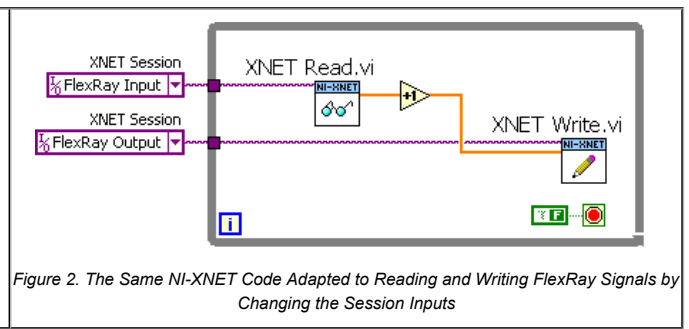
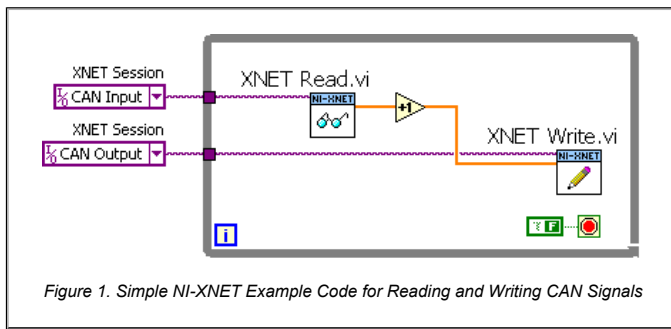

Integration With NI Products

Microsecond-level timestamping, external timebase support, and PXI/RTSI triggering enable NI-XNET interfaces to integrate with hundreds of NI PCI and PXI devices for a wide variety of custom applications, ranging from synchronized data acquisition and bus-level measurements to fault-insertion and large distributed systems.

For National Instruments 986x NI-XNET interfaces used in NI CompactDAQ and NI CompactRIO chassis, you achieve triggering and synchronization with other modules through the sharing of the same clock in the hardware backplane.

Integrated Signal Databases

The NI-XNET API automatically translates CAN, LIN, and FlexRay frames to engineering-level signals, a feature often found only in expensive turnkey applications. With integrated support for industry-standard signal databases including FIBEX, CANdb (.DBC), LDF, and NI-CAN (.NCD), NI-XNET simplifies building custom applications to work with other tools in complex embedded design workflows.

Backward Compatibility

NI-XNET interfaces are compatible with most legacy NI-CAN Frame and Channel API applications written for NI Series 2 and USB CAN interfaces. The NI-XNET NI-CAN compatibility layer operates at the driver level, ensuring a drop-in performance boost to established in-house applications without time-consuming code refactoring and recompiling. NI-XNET is not compatible with applications written for USB-LIN.

NI Device-Driven DMA Engine

The patent-pending NI-XNET device-driven DMA engine reduces system latency, a common pain point for PC-based CAN interfaces, from milliseconds to microseconds. The engine enables the onboard processor to move frames and signals between the interface and the user program without CPU interrupts, freeing host processor time for processing complex models and applications.

NI-XNET Hardware

NI-XNET interfaces are available for CAN, LIN, and FlexRay in PCI, PXI, NI CompactDAQ, and NI CompactRIO form factors, and in one- and two-port models.

- PCI/PXI-8511 Low-Speed/Fault-Tolerant (LS) CAN
- PCI/PXI-8512 High-Speed/FD (HS/FD) CAN
- PCI/PXI-8513 Software-Selectable/FD (XS/FD) CAN
- PCI/PXI-8517 FlexRay
- PCI/PXI-8516 LIN
- NI 9862 High-Speed/FD (HS/FD) CAN
- NI 9861 Low-Speed/Fault-Tolerant (LS) CAN
- NI 9866 LIN

NI-XNET software-selectable interfaces offer the best flexibility for CAN development with onboard transceivers for high-speed/FD, low-speed/fault-tolerant, and single-wire CAN. All specifications in this document apply equally to 1- and 2-port models unless otherwise specified.

NI-XNET Software

The NI-XNET driver software and utilities are included at no additional charge with all NI-XNET CAN, LIN, and FlexRay interfaces.

NI-XNET API

The NI-XNET API provides function calls in LabVIEW, LabWindows/CVI, and C/C++ so you can easily send and receive CAN, LIN, and FlexRay signals and frames to and from your application. You can choose from 12 data transfer modes to optimize the data transfer for a particular application:



- **Single-point signal input and output modes** read and write the most recent values received for each signal. These modes are ideal for control and simulation applications that use up to hundreds of simultaneous signals, which is common for hardware-in-the-loop applications.
- **Waveform signal input and output modes** use the time when the signal frame is received to resample the signal data to a waveform at a fixed sample rate. These modes typically are used for synchronizing NI-XNET data with NI-DAQmx analog/digital input channels and plotting waveforms.
- **XY signal input and output modes** return exact XY pairs of a signal's timestamp and its value. This is especially useful for knowing to the microsecond when a signal was last updated.
- **Stream input and output modes for frames** read or write every frame on the network. These modes are used for analyzing and logging all frame traffic on the network.
- **Queued frame input and output modes** read and write frame data from a dedicated queue per frame. These modes enable your application to read a sequence of data specific to a frame (for example, CAN identifier).

NI-XNET LabVIEW Project Sessions

The NI-XNET API installs extra support for LabVIEW users to streamline programming on Windows and real-time targets. With NI-XNET sessions, configuration and setup information is stored in the project, which reduces coding and simplifies signal management.

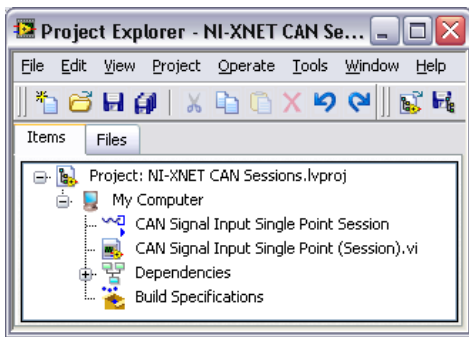

Figure 3. NI-XNET Session

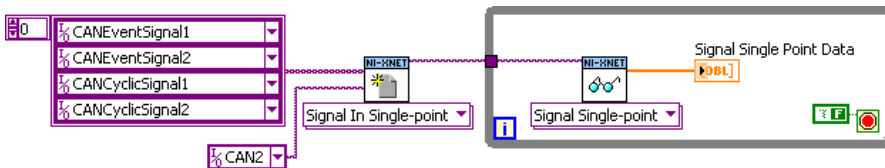

Figure 4. NI-XNET Code Without Sessions

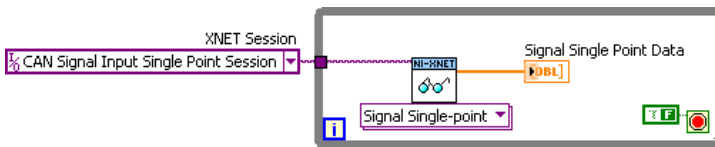

Figure 5. NI-XNET code with sessions eliminates setup code and reduces clutter for complicated programs.

NI-XNET Utilities

NI-XNET Database Editor

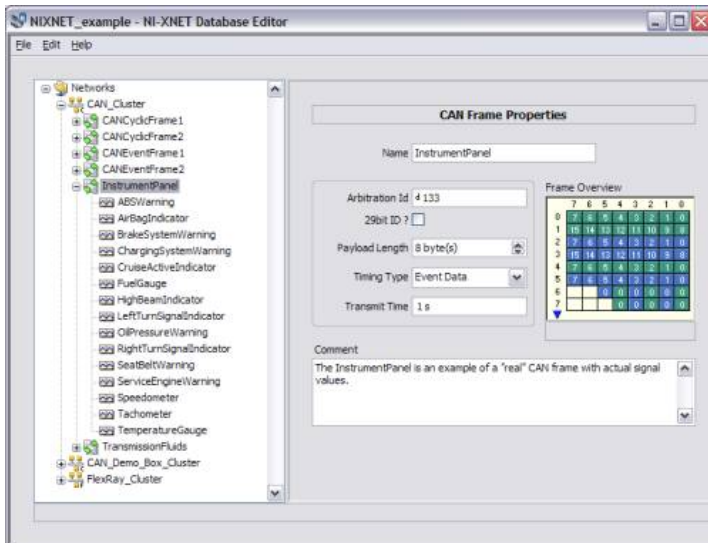

Figure 6. NI-XNET Database Editor

The NI-XNET Database Editor is a stand-alone tool for creating and maintaining embedded network databases that contain signals, frames, and network parameters. NI-XNET products use the ASAM FIBEX (Field Bus EXchange) standard as the primary database storage format. In addition to FIBEX, the NI-XNET Database Editor can import the NI-CAN database format (.NCD) and CANdb format (.DBC) and convert them to FIBEX.

Use the editor to

- Configure a basic new network from scratch or import an existing network such as a network from a large project
- Define and modify frames and signals exchanged on the network
- Assign frames to corresponding ECUs

NI-XNET Bus Monitor

- Measure bus load and monitor bus load history
- Transmit single and periodic test frames
- Map frames to database names for easier diagnostics

- View CAN, LIN, and FlexRay bus statistics
- Log raw frame data to disk as ASCII or binary NI CAN Logfile format (.NCL)

NI I/O Trace Debugging Tool Integration

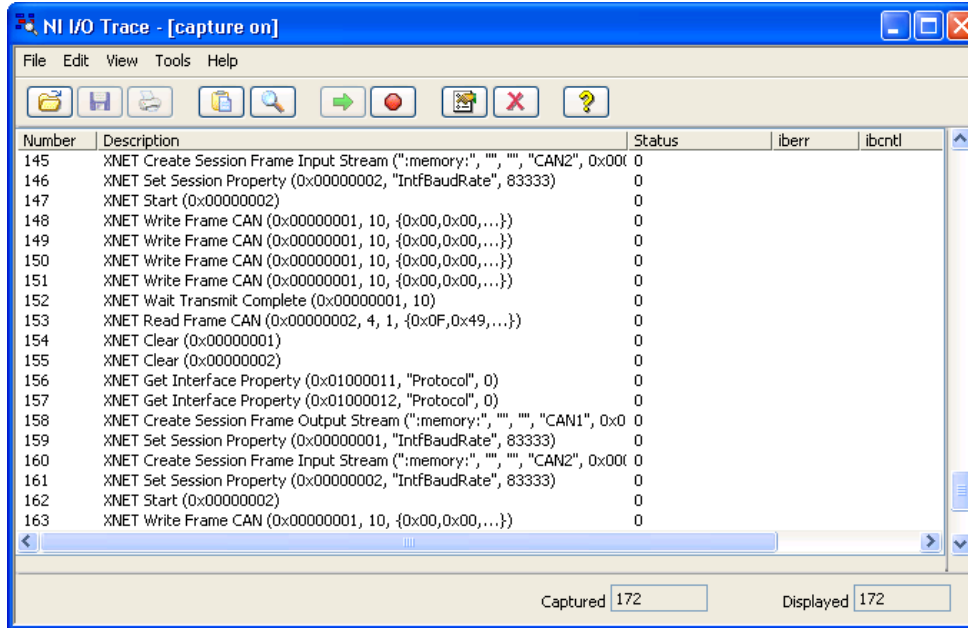

Figure 7. NI I/O Trace Utility

The NI I/O Trace utility monitors function calls to the NI-XNET APIs from user applications to help troubleshoot applications without adding complex and time-consuming debugging code. This tool helps you debug application programming problems, regardless of the programming environment used.



NI-CAN Application Compatibility





NI-XNET interfaces are compatible with most legacy NI-CAN Channel API and NI-CAN Frame API applications written for legacy NI Series 2 CAN and USB CAN interfaces. The NI-XNET NI-CAN compatibility layer operates at the driver level, ensuring a drop-in performance boost to established in-house applications without time-consuming code refactoring and recompiling. NI-XNET NI-CAN compatibility layer is not compatible with NI 986x NI-XNET interfaces or with applications written for USB-LIN.

Signal Databases

NI-XNET driver software natively works with FIBEX, CANdb (.DBC), LDF, and NI-CAN (.NCD) signal database files. With the database model built into the driver, the tedious task of scaling byte-level frames into real engineering units is offloaded from the host program, which simplifies programming and maintains consistent results as network configurations evolve over the design of the system. The resulting simpler code is more readable, easier to maintain, and more scalable between generations of systems.

NI-XNET Cables and Accessories

<p>CAN Device Simulator</p> <p>The NI CAN Device Simulator, when communicating with NI CAN and data acquisition (DAQ) hardware on a PC, provides a tool to demonstrate the concepts of CAN communication, DAQ, and CAN/DAQ synchronization. The NI CAN Device Simulator has a digital function generator; one high-speed CAN interface; one high-speed CAN monitor connector; a 68-pin DAQ connector; access to the DAQ interface; TRIG1, TRIG2, and FREQOUT pins; and digital input switches.</p>	
<p>CAN Breakout Box</p> <p>The NI CAN breakout box features 14 parallel wired ports for branching additional CAN devices to an NI CAN interface or other CAN network. Seven connectors use standard NI CAN D-SUB pinouts for connections to NI CAN cables and devices, while the other seven connectors are COMBICON 5-pin screw-terminal removable connectors for easy connections to bare wires. The onboard power supply applies power to the V+ pins on the bus, which is required for some transceivers, and switchable 120 Ω, 60 Ω, or no-termination simplifies connections to most CAN devices.</p>	
<p>CAN, LIN, and FlexRay Cables</p> <p>NI-XNET interfaces feature onboard software-enabled termination, which eliminates the need for termination resistors in CAN or LIN cables. NI recommends no-termination CAN and LIN cables for use with NI-XNET CAN and LIN interfaces. For NI-XNET FlexRay interfaces, use 9-pin D-SUB cables to connect to ECUs and FlexRay devices.</p>	

	
CAN to OBD-II Cable	
<p>The NI CAN to OBD-II cable connects an NI high-speed CAN interface to the standard J1962 diagnostic connector found in late-model automobiles for diagnostic applications.</p>	
RTSI Cables	
<p>PCI NI-XNET interfaces feature a RTSI bus connector for synchronization with other PCI NI-XNET interfaces and NI PCI and PCI Express devices, such as DAQ, modular instruments, vision, and motion, that support RTSI.</p>	
SMB External Sync Cables	
<p>NI 8513 and NI 8517 NI-XNET interfaces include external synchronization SMB connectors that you can use to input or output synchronization signals to other NI instruments, external instrumentation, or custom circuits.</p>	

[Back to Top](#)

Ordering Information

For a complete list of accessories, visit the product page on ni.com.

Products	Part Number	Recommended Accessories	Part Number
NI PXI-8511			
NI PXI-8511 Requires: 1 Cable , 1 Connector Block ;	780686-01	Cable: 9_pin_D-sub_female - NI CAN No Termination Cable (1m)	193128-01
		Connector Block: - CAN Breakout Box	780041-01
NI PXI-8511/2			
NI PXI-8511/2 Requires: 1 CAN Breakout Box , 2 Cables ;	780686-02	CAN Breakout Box: CAN_Accessories - CAN Breakout Box	780041-01
		Cables: 9_pin_D-sub_female - NI CAN No Termination Cable (1m)	193128-01
NI PCI-8512			
NI PCI-8512 Requires: 1 Cables , 1 Connector Blocks ;	780683-01	Cables: 9_pin_D-sub_female - NI CAN Single Termination Cable (2m) <i>**Also Available: [SAE_OBD_male]</i>	192017-02
		Connector Blocks: - CAN Breakout Box	780041-01
NI PXI-8512			
NI PXI-8512	780687-01	Cable: 9_pin_D-sub_female - NI CAN Single Termination Cable (2m)	192017-02

Requires: 1 Cable , 1 Connector Block ;		**Also Available: [SAE_OBD_male]	
		Connector Block: CAN_Accessories - CAN Breakout Box	780041-01
NI PCI-8512/2			
NI PCI-8512/2	780683-02	Cables: 9_pin_D-sub_female - NI CAN Single Termination Cable (2m) **Also Available: [SAE_OBD_male]	192017-02
Requires: 2 Cables , 1 Connector Blocks ;		Connector Blocks: - CAN Breakout Box	780041-01
NI PCI-8513			
NI PCI-8513	780684-01	Cables: 9_pin_D-sub_female - NI CAN Single Termination Cable (2m) **Also Available: [SAE_OBD_male]	192017-02
Requires: 1 Cables , 1 Connector Blocks ;		Connector Blocks: - CAN Breakout Box	780041-01
NI PXI-8513			
NI PXI-8513	780688-01	Cable: 9_pin_D-sub_female - NI CAN Single Termination Cable (2m) **Also Available: [SAE_OBD_male]	192017-02
Requires: 1 Cable , 1 Connector Block ;		Connector Block: - CAN Breakout Box	780041-01
NI PCI-8513/2			
NI PCI-8513/2	780684-02	Cables: 9_pin_D-sub_female - NI CAN Single Termination Cable (2m) **Also Available: [SAE_OBD_male]	192017-02
Requires: 2 Cables , 1 Connector Blocks ;		Connector Blocks: - CAN Breakout Box	780041-01
NI PXI-8513/2			
NI PXI-8513/2	780688-02	Connector 0:	
Requires: 1 Cable , 1 Connector Block ;		Cable: 9_pin_D-sub_female - NI CAN No Termination Cable (1m) **Also Available: [SAE_OBD_male]	193128-01
		Connector Block: CAN_Accessories - CAN Breakout Box **Also Available: [null]	780041-01
		Connector 1:	
		Cable: 9_pin_D-sub_female - NI CAN No Termination Cable (1m) **Also Available: [SAE_OBD_male]	193128-01
		Connector Block: CAN_Accessories - CAN Breakout Box **Also Available: [null]	780041-01
NI PXI-8517/2			
NI PXI-8517/2	780689-02	Cable: Shielded - SHDE9F-DE9F-FX-FlexRay Cable (No Termination) (1m)	198290-01
Requires: 2 Cable ;			

[Back to Top](#)

Software Recommendations

NI Automotive Diagnostic Command Set

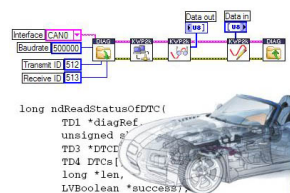

- Ability to implement automotive diagnostics in LabVIEW, LabWindows™/CVI, Visual C/C++ 6.0
- Compatibility with Windows 7/Vista/XP/2000 and LabVIEW Real-Time
- KWP2000 (ISO 14230), Diagnostics on CAN (ISO 15765, OBD-II), and Diagnostics over IP (ISO 13400)
- Transport protocols: ISO Transport Protocol 15765-2 and Volkswagen TP 2.0
- Compatible interfaces: NI-XNET CAN, CompactRIO CAN, USB CAN, and Series 2 NI CAN (PXI, PCI, PCMCIA)
- Examples for KWP2000 and UDS, including a software ECU simulator

NI CANopen LabVIEW Library

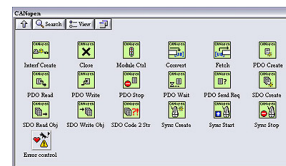

- NI LabVIEW function blocks to create CANopen master applications
- Transmit-and-receive process data objects (PDOs) and service data objects (SDOs)
- Support for all NI Series 2 high-speed CAN interfaces
- LabVIEW Real-Time support with Series 2 PXI high-speed CAN interfaces
- Network management, heartbeat, node guarding, and synchronization functions
- NI does not recommend the NI CANopen LabVIEW Library for use in new designs.

NI ECU Measurement and Calibration Toolkit

- CAN Calibration Protocol (CCP) Version 2.1 support
- Access to ECU physical values (DAQ and STIM lists) for measurement and simulation applications
- Universal Measurement and Calibration Protocol (XCP) master functionality on CAN and Ethernet
- Access to internal ECU characteristics (1D to 3D) and support for *.A2L database files

NI LabVIEW Real-Time Module

- Design deterministic real-time applications with LabVIEW graphical programming
- Download to dedicated NI or third-party hardware for reliable execution and a wide selection of I/O
- Take advantage of built-in PID control, signal processing, and analysis functions
- Automatically take advantage of multicore CPUs or set processor affinity manually

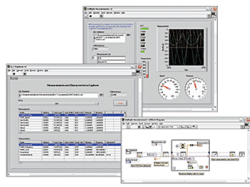

Compatibility with all NI PCI, PXI, PCMCIA, USB, and C Series CAN interfaces

- Included XCP and CCP Master add-on for NI VeriStand

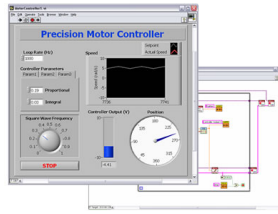

- Includes real-time OS, development and debugging support, and board support
- Purchase individually or as part of a LabVIEW suite

[Back to Top](#)

Support and Services

System Assurance Programs

NI system assurance programs are designed to make it even easier for you to own an NI system. These programs include configuration and deployment services for your NI PXI, CompactRIO, or Compact FieldPoint system. The NI Basic System Assurance Program provides a simple integration test and ensures that your system is delivered completely assembled in one box. When you configure your system with the NI Standard System Assurance Program, you can select from available NI system driver sets and application development environments to create customized, reorderable software configurations. Your system arrives fully assembled and tested in one box with your software preinstalled. When you order your system with the standard program, you also receive system-specific documentation including a bill of materials, an integration test report, a recommended maintenance plan, and frequently asked question documents. Finally, the standard program reduces the total cost of owning an NI system by providing three years of warranty coverage and calibration service. Use the online product advisors at ni.com/advisor to find a system assurance program to meet your needs.

Technical Support

Get answers to your technical questions using the following National Instruments resources.

- **Support** - Visit ni.com/support to access the NI KnowledgeBase, example programs, and tutorials or to contact our applications engineers who are located in NI sales offices around the world and speak the local language.
- **Discussion Forums** - Visit forums.ni.com for a diverse set of discussion boards on topics you care about.
- **Online Community** - Visit community.ni.com to find, contribute, or collaborate on customer-contributed technical content with users like you.

Repair

While you may never need your hardware repaired, NI understands that unexpected events may lead to necessary repairs. NI offers repair services performed by highly trained technicians who quickly return your device with the guarantee that it will perform to factory specifications. For more information, visit ni.com/repair.

Training and Certifications

The NI training and certification program delivers the fastest, most certain route to increased proficiency and productivity using NI software and hardware. Training builds the skills to more efficiently develop robust, maintainable applications, while certification validates your knowledge and ability.

- **Classroom training in cities worldwide** - the most comprehensive hands-on training taught by engineers.
- **On-site training at your facility** - an excellent option to train multiple employees at the same time.
- **Online instructor-led training** - lower-cost, remote training if classroom or on-site courses are not possible.
- **Course kits** - lowest-cost, self-paced training that you can use as reference guides.
- **Training memberships** and training credits - to buy now and schedule training later.

Visit ni.com/training for more information.

Extended Warranty

NI offers options for extending the standard product warranty to meet the life-cycle requirements of your project. In addition, because NI understands that your requirements may change, the extended warranty is flexible in length and easily renewed. For more information, visit ni.com/warranty.

OEM

NI offers design-in consulting and product integration assistance if you need NI products for OEM applications. For information about special pricing and services for OEM customers, visit ni.com/oem.

Alliance

Our Professional Services Team is comprised of NI applications engineers, NI Consulting Services, and a worldwide National Instruments Alliance Partner program of more than 700 independent consultants and integrators. Services range from start-up assistance to turnkey system integration. Visit ni.com/alliance.

[Back to Top](#)

Detailed Specifications

Power Requirements

Model	Specification	Value
PCI/PXI-8511, PCI/PXI-8512,	+3.3 VDC	940 mA

PCI/PXI-8513	+5 VDC	640 mA
PCI/PXI-8517	+3.3 VDC	940 mA
PCI/PXI-8516	+3.3 VDC	940 mA
NI 986x	Power Consumption	Active Mode: 1W Max
	Thermal Dissipation (70°C)	Active Mode: 1.5W Max

Synchronization

RTSI/Front Panel Sync Connectors

All NI-XNET PCI interfaces feature an NI RTSI synchronization connector for routing synchronization signals between NI RTSI-enabled boards. To synchronize signals with other NI RTSI-enabled boards, use RTSI ribbon cables.

All NI-XNET PXI interfaces route RTSI signals over the PXI timing and synchronization bus located in the PXI backplane. NI PCI/PXI-8513 and 8517 interfaces feature front-panel sync connectors for routing timing and synchronization signals to external equipment.

All NI-XNET C Series interfaces in an NI CompactDAQ or NI CompactRIO chassis automatically share a common timebase with other modules in the chassis. For information about routing the start trigger for NI CompactDAQ, refer to the NI-XNET readme file.

Model	Specification	Value
All PCI/PXI NI-XNET Interfaces	Trigger Lines	7 Input/Output
	Clock Lines	1 Input/Output
	I/O Compatibility	TTL
	Power-On State	Input (High-Z)
	Response	Rising Edge Triggers
	Master Timebase Source	1 MHz, 10 MHz, 20 MHz
PCI/PXI-8513, PCI/PXI-8517	Front Panel Sync Connectors	2 Input/Output
PCI Interfaces	Synchronization Connectivity	NI RTSI Connector
PXI Interfaces	Synchronization Connectivity	PXI Timing and Synchronization Bus

Synchronization Sources

Model	Synchronization Sources
All PCI/PXI NI-XNET Interfaces	PCI and PXI Trigger Lines
	Start Trigger
	Comm Trigger
PCI/PXI-8517 FlexRay	FlexRay Start of Cycle
	FlexRay Macrotick
PXI Interfaces	PXI Star Trigger Lines
	PXI 10 MHz backplane clock
PCI/PXI-8513, PCI/PXI-8517	Front Panel SMB Terminals

Synchronization Destinations

Model	Synchronization Sources
All PCI/PXI NI-XNET Interfaces	PCI and PXI Trigger Lines
	Start Trigger
	Master Timebase
PCI/PXI-8513, PCI/PXI-8517	Front Panel SMB Terminals

Physical

Model	Dimensions	Ports	9-Pin Male D-sub I/O Connectors	SMB Ext. Sync Connector
PCI-8511 LS	10.67 x 16.76 cm (4.2 x 6.6 in.)	1	1	-
PCI-8511/2 LS	10.67 x 16.76 cm (4.2 x 6.6 in.)	2	2	-
PCI-8512 HS	10.67 x 16.76 cm (4.2 x 6.6 in.)	1	1	-
PCI-8512/2 HS	10.67 x 16.76 cm (4.2 x 6.6 in.)	2	2	-
PCI-8513 XS	10.67 x 16.76 cm (4.2 x 6.6 in.)	1	1	2
PCI-8513/2 XS	10.67 x 16.76 cm (4.2 x 6.6 in.)	2	2	2
PCI-8516 LIN	10.67 x 16.76 cm (4.2 x 6.6 in.)	2	2	-
PCI-8517/2 FlexRay	10.67 x 16.76 cm (4.2 x 6.6 in.)	2	2	2
PXI-8511 LS	10.00 x 16.00 cm (3.9 x 6.3 in.)	1	1	-
PXI-8511/2 LS	10.00 x 16.00 cm (3.9 x 6.3 in.)	2	2	-
PXI-8512 HS	10.00 x 16.00 cm (3.9 x 6.3 in.)	1	1	-
PXI-8512/2 HS	10.00 x 16.00 cm (3.9 x 6.3 in.)	2	2	-
PXI-8513 XS	10.00 x 16.00 cm (3.9 x 6.3 in.)	1	1	2
PXI-8513/2 XS	10.00 x 16.00 cm (3.9 x 6.3 in.)	2	2	2
PXI-8516 LIN	10.00 x 16.00 cm (3.9 x 6.3 in.)	2	2	-
PXI-8517/2 FlexRay	10.00 x 16.00 cm (3.9 x 6.3 in.)	2	2	2

NI 9862	7.9 x 8.9 x 2.3 cm (3.1 x 3.5 x 0.9 in.)	1	1	-
NI 9861	7.9 x 8.9 x 2.3 cm (3.1 x 3.5 x 0.9 in.)	1	1	-
NI 9866	7.9 x 8.9 x 2.3 cm (3.1 x 3.5 x 0.9 in.)	1	1	-

Environment

Model	Specification	Value
All PCI/PXI NI-XNET interfaces	Operating ambient temperature	0 to 55 °C
	Operating relative humidity	10 to 90%, noncondensing
	Storage ambient temperature	-20 to 70 °C
	Storage relative humidity	5 to 95%, noncondensing
NI 986x interfaces	Operating ambient temperature	-40 to 70 °C
	Operating relative humidity	10 to 90%, noncondensing
	Storage ambient temperature	-40 to 85 °C
	Storage relative humidity	5 to 95%, noncondensing

Isolation

NI-XNET interfaces use DC-to-DC converters and galvanic isolation on all interfaces to protect from transient voltages and ground loops. Isolation helps prevent errors associated with different ground planes common in test equipment setups.

Model	Specification	Value
All PCI/PXI NI-XNET interfaces	Isolation voltage	500 VDC
	Isolation type	Channel-to-bus, channel-to-channel
NI 986x interfaces	Isolation voltage	Withstand: 1000 Vrms
		Continuous: 60 VDC
	Isolation type	Port-to-earth ground

Cabling Requirements

Model	Physical Layer	Specification	Value
PCI/PXI-8511, PCI/PXI-8513, NI 9861	CAN Low-Speed/ Fault-Tolerant	Length-related capacitance, CAN_L to ground, CAN_H to ground, CAN_L to CAN_H	30 pF/m nominal
		Length-related resistance	90 mΩ/m nominal
PCI/PXI-8512, PCI/PXI-8513, NI 9862	CAN High-Speed	Impedance	108-132 Ω, 120 Ω nominal
PCI/PXI-8513	CAN Single-Wire	Specific Line Delay	5 ns/m
		Length-related resistance	70 mΩ /m nominal
		Max cable length @ 1 Mbit/s (Refer to ISO 11898 Specification)	40 m
		Max stub length @ 1 Mbit/s (Refer to ISO 11898 Specification)	0.3 m
		NI recommended cable	Belden cable (3084A)
PCI/PXI-8517	FlexRay	Max length (Refer to SAE J2411 Specification)	60 m
		Cable attenuation	82 dB/km
		Impedance	80-110 Ω @ 10 MHz
		Specific line delay	10 ns/m
PCI/PXI-8516, NI 9866	LIN	Maximum point-to-point length (Refer to FlexRay specification)	24 m
		The maximum allowable cable length	40m

Termination

CAN and FlexRay networks require correct cabling termination to function correctly. This involves placing a correctly specified resistor at either end of the network. All NI-XNET interfaces feature software-selectable termination to simplify cabling requirements and improve testing abilities. The onboard termination varies by physical layer.

Model	Physical Layer	Software-Selectable Termination Options
PCI/PXI-8511, PCI/PXI-8513, NI 9861	Low-Speed/Fault-Tolerant CAN	1.11 kΩ, 4.99 kΩ
PCI/PXI-8512, PCI/PXI-8513, NI 9862	High-Speed CAN	None, 120 Ω
PCI/PXI-8513	Single-Wire CAN	9.09 kΩ Only
PCI/PXI-8516, NI 9866	LIN	None, 1 kΩ
PCI/PXI-8517	FlexRay	None, 80 Ω (between bus minus and bus plus for both channels A and B)

CAN Termination Resistor Placement

The termination resistors on a cable should match the nominal impedance of the cable. ISO 11898 requires a cable with a nominal impedance of 120 Ω, so you should use a 120 Ω resistor at each end of the cable. Each termination resistor should be capable of dissipating 0.25 W of power.

High-Speed CAN

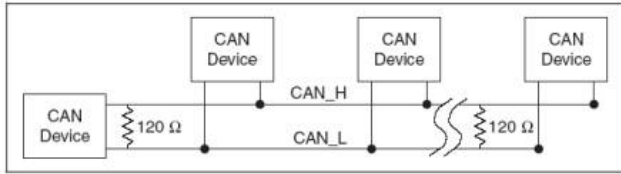

Low-Speed/Fault-Tolerant CAN

Every device on the Low-Speed CAN network requires a termination resistor for each CAN data line: R_{RTH} for CAN_H and R_{RTL} for CAN_L. Formulas for calculating these resistor values can be found in the *NI-XNET Hardware and Software manual* or the ISO-11898 specification.

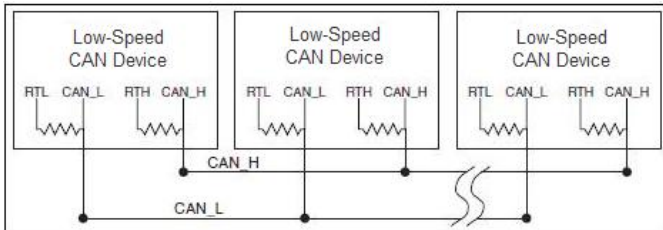

Bus Power Requirements

Model	Physical Layer	External Bus Power Requirements
PCI/PXI-8511, PCI/PXI-8513	Low-Speed/Fault-Tolerant CAN	None. V- serves as reference ground
PCI/PXI-8512, PCI/PXI-8513	High-Speed CAN	None. V- serves as reference ground
PCI/PXI-8513	Single-Wire CAN	8-18 VDC required, 12 VDC recommend on V+
PCI/PXI-8516	LIN	8-18 VDC on VBat connector pin (referenced to COM)
PCI/PXI-8517	FlexRay	None. COM serves as reference ground
NI 9862	High-Speed CAN	9-30 VDC required on Vsup (pin 9)
NI 9861	Low-Speed/Fault-Tolerant CAN	9-30 VDC required on Vsup (pin 9)
NI 9866	LIN	8-18 VDC on VBat connector pin (referenced to COM)

Low-Speed/Fault-Tolerant CAN Physical Layer (PCI/PXI-8511, 8513)

Transceiver

CAN Low-Speed/Fault-Tolerant hardware uses the Philips TJA1054A Low-Speed/Fault-Tolerant transceiver. The TJA1054A supports baud rates up to 125 kbit/s. The transceiver can detect and automatically recover from the following CAN bus failures:

- CAN_H wire interrupted
- CAN_L wire interrupted
- CAN_H short-circuited to battery
- CAN_L short-circuited to battery
- CAN_H short-circuited to VCC
- CAN_L short-circuited to VCC
- CAN_H short-circuited to ground
- CAN_L short-circuited to ground
- CAN_H and CAN_L mutually short-circuited

The TJA1054A supports advanced power management through a low-power sleep mode.

Software Selectable CAN Interfaces (PCI/PXI-8513)

With NI-XNET PCI/PXI-8513 interfaces, you can select each port individually on one of the following transceivers:

- High-Speed
- Low-Speed/Fault-Tolerant
- Single Wire

When a transceiver is selected, it connects its onboard transceivers to the port and behaves the same as a dedicated interface. Software-selectable interfaces are ideal for applications that require interfacing with multiple types of CAN networks such as production test, verification and validation, and flexible hardware-in-the-loop simulators.

Cable and Accessory Compatibility

Model	Physical Layer	Compatible Cables and Accessories	Part Number
	All CAN	CAN D-Sub F to D-Sub F Cable, No Termination, 1 m	193128-01

PCI/PXI-8511, PCI/PXI-8512, PCI/PXI-8513, NI 9862, NI 9861		CAN D-Sub F to D-Sub F Cable, No Termination, 2 m	193128-02
		CAN Breakout Box, 14-Port	780041-01
PCI/PXI-8512, PCI/PXI-8513, NI 9862	CAN High-Speed	CAN OBD-II Cable	193942-02
		CAN Device Simulator (USA 120 VAC)	779189-01
		CAN Device Simulator (Universal Europe 240 VAC)	779189-02
		CAN Device Simulator (Japan 100 VAC)	779189-07
PCI/PXI-8517	FlexRay	FlexRay D-Sub F to D-Sub F Cable, 2 m	198290-01
All PCI NI-XNET Interfaces	All	RTSI Bus Cable, 2 Boards	776249-02
		RTSI Bus Cable, 3 Boards	776249-03
		RTSI Bus Cable, 4 Boards	776249-04
		RTSI Bus Cable, 5 Boards	776249-05
		RTSI Bus Cable, 5 Boards, Extended	777562-05
PCI/PXI-8513, PCI/PXI-8517	All	SMB100, SMB to BNC Female Cable, 50 Ω , 0.6 m	763389-01
		SMB110, SMB to BNC Male Coax Cable, 50 Ω , 1 m	763405-01
		SMB200, SMB to SMB Coax Cable, 50 Ω , 0.3 m	763390-01
		SMB200, SMB to SMB Coax Cable, 50 Ω , 1 m	188859-01
		SMB300, SMB to Mini-Alligator Clips Cable, 50 Ohm, 1 m	763388-01
PCI/PXI-8516, NI 9866	LIN	CAN D-Sub F to D-Sub F Cable, No Termination, 1 m	193128-01
		CAN Breakout Box, 14-Port	780041-01

[Back to Top](#)

Pinouts/Front Panel Connections

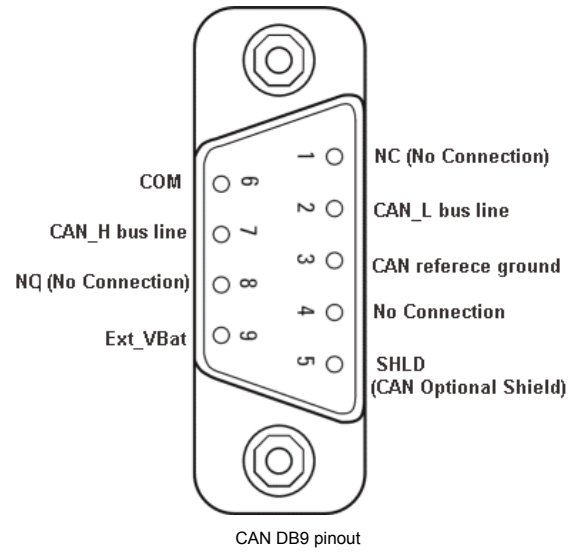

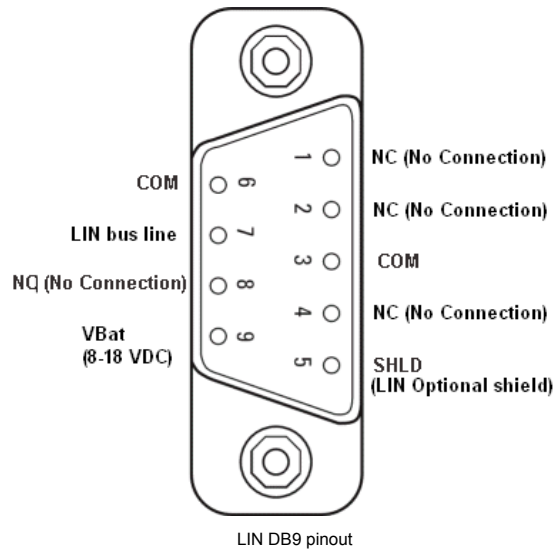

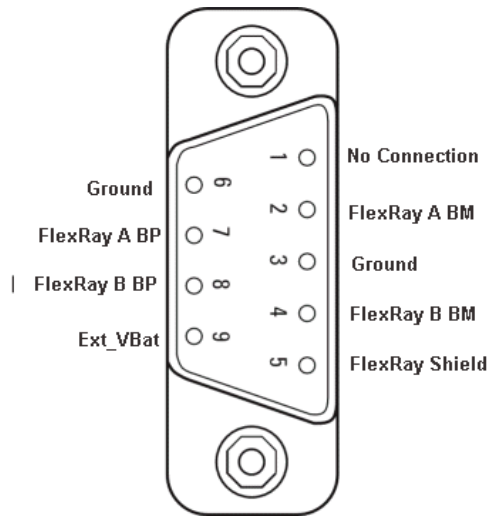

FlexRay DB9 pinout

[Back to Top](#)

©2011 National Instruments. All rights reserved. CompactRIO, CVI, FieldPoint, LabVIEW, National Instruments, National Instruments Alliance Partner, NI, ni.com, NI CompactDAQ, and RTSI are trademarks of National Instruments. The mark LabWindows is used under a license from Microsoft Corporation. Windows is a registered trademark of Microsoft Corporation in the United States and other countries. Other product and company names listed are trademarks or trade names of their respective companies. A National Instruments Alliance Partner is a business entity independent from National Instruments and has no agency, partnership, or joint-venture relationship with National Instruments.

[My Profile](#) | [RSS](#) | [Privacy](#) | [Legal](#) | [Contact NI](#) © 2014 National Instruments Corporation. All rights reserved.



Artisan Technology Group is your source for quality new and certified-used/pre-owned equipment

- FAST SHIPPING AND DELIVERY
- TENS OF THOUSANDS OF IN-STOCK ITEMS
- EQUIPMENT DEMOS
- HUNDREDS OF MANUFACTURERS SUPPORTED
- LEASING/MONTHLY RENTALS
- ITAR CERTIFIED SECURE ASSET SOLUTIONS

SERVICE CENTER REPAIRS

Experienced engineers and technicians on staff at our full-service, in-house repair center

*InstraView*SM REMOTE INSPECTION

Remotely inspect equipment before purchasing with our interactive website at www.instraview.com ↗

WE BUY USED EQUIPMENT

Sell your excess, underutilized, and idle used equipment. We also offer credit for buy-backs and trade-ins. www.artisanng.com/WeBuyEquipment ↗

LOOKING FOR MORE INFORMATION?

Visit us on the web at www.artisanng.com ↗ for more information on price quotations, drivers, technical specifications, manuals, and documentation

Contact us: (888) 88-SOURCE | sales@artisanng.com | www.artisanng.com