



## Artisan Technology Group is your source for quality new and certified-used/pre-owned equipment

- FAST SHIPPING AND DELIVERY
- TENS OF THOUSANDS OF IN-STOCK ITEMS
- EQUIPMENT DEMOS
- HUNDREDS OF MANUFACTURERS SUPPORTED
- LEASING/MONTHLY RENTALS
- ITAR CERTIFIED SECURE ASSET SOLUTIONS

### SERVICE CENTER REPAIRS

Experienced engineers and technicians on staff at our full-service, in-house repair center

### *InstraView*<sup>SM</sup> REMOTE INSPECTION

Remotely inspect equipment before purchasing with our interactive website at [www.instraview.com](http://www.instraview.com) ↗

### WE BUY USED EQUIPMENT

Sell your excess, underutilized, and idle used equipment. We also offer credit for buy-backs and trade-ins. [www.artisanng.com/WeBuyEquipment](http://www.artisanng.com/WeBuyEquipment) ↗

### LOOKING FOR MORE INFORMATION?

Visit us on the web at [www.artisanng.com](http://www.artisanng.com) ↗ for more information on price quotations, drivers, technical specifications, manuals, and documentation

**Contact us:** (888) 88-SOURCE | [sales@artisanng.com](mailto:sales@artisanng.com) | [www.artisanng.com](http://www.artisanng.com)

**V720-series**  
**Electromagnetic Inductive**  
**RFID System**  
**V720-H01-E**  
**V720-D52P**

**Read/Write Antenna**  
**Tag**

# OPERATION MANUAL

**OMRON**

**V720-series  
Electromagnetic Inductive  
RFID System  
V720-H01-E Read/Write Antenna  
V720-D52P□□ Tag  
Operation Manual**

*Revised October 2000*





## Notice:

OMRON products are manufactured for use according to proper procedures by a qualified operator and only for the purposes described in this manual.

The following conventions are used to indicate and classify precautions in this manual. Always heed the information provided with them. Failure to heed precautions can result in injury to people or damage to property.

 **DANGER** Indicates an imminently hazardous situation which, if not avoided, will result in death or serious injury.

 **WARNING** Indicates a potentially hazardous situation which, if not avoided, could result in death or serious injury.

 **Caution** Indicates a potentially hazardous situation which, if not avoided, may result in minor or moderate injury, or property damage.

## Visual Aids

The following headings appear in the left column of the manual to help you locate different types of information.

**Note** Indicates information of particular interest for efficient and convenient operation of the product.

**1, 2, 3...** 1. Indicates lists of one sort or another, such as procedures, checklists, etc.

## © OMRON, 2000

All rights reserved. No part of this publication may be reproduced, stored in a retrieval system, or transmitted, in any form, or by any means, mechanical, electronic, photocopying, recording, or otherwise, without the prior written permission of OMRON.

No patent liability is assumed with respect to the use of the information contained herein. Moreover, because OMRON is constantly striving to improve its high-quality products, the information contained in this manual is subject to change without notice. Every precaution has been taken in the preparation of this manual. Nevertheless, OMRON assumes no responsibility for errors or omissions. Neither is any liability assumed for damages resulting from the use of the information contained in this publication.



# TABLE OF CONTENTS

<b>PRECAUTIONS</b> .....	
1 Intended Audience .....	
2 General Precautions .....	
3 Safety Precautions .....	
4 Application Precautions .....	
5 Correct Use .....	
6 Applicable Standards .....	
7 EN/IEC Standards .....	
8 FCC Notices .....	
<b>SECTION 1</b>	
<b>Characteristics</b> .....	
Characteristics .....	
<b>SECTION 2</b>	
<b>Specifications and Performance</b> .....	
2-1 Read Write Antenna .....	
2-2 Tags .....	
2-3 Cable .....	
<b>SECTION 3</b>	
<b>Installation</b> .....	
3-1 Installation of Antenna .....	
3-2 Installation of Tag .....	
<b>SECTION 4</b>	
<b>Reference Data</b> .....	
4-1 Communications Areas .....	
4-2 Influence of Tag Angle .....	
4-3 Effects of Materials on Tags .....	
<b>Revision History</b> .....	

## ***About this Manual:***

This manual describes the installation and operation of the V720-series Electromagnetic Inductive RFID System (V720-H01-E Read Write Antenna and V720-D52P30 and V720-D52P40 RFID Tags) and includes the sections described below.

Please read this manual carefully and be sure you understand the information provided before attempting to install and operate the V720-series Electromagnetic Inductive RFID System.

**Section 1** provides the characteristics of the components that make up the V720 System.

**Section 2** provides the specifications and performance characteristics of the components of the V720 System.

**Section 3** provides installation information for the V720 System.

**Section 4** provides reference data relating to V720 communications areas.



### **WARNING**

Failure to read and understand the information provided in this manual may result in personal injury or death, damage to the product, or product failure. Please read each section in its entirety and be sure you understand the information provided in the section and related sections before attempting any of the procedures or operations given.



# PRECAUTIONS

This section provides general precautions for using the V720-series Electromagnetic Inductive RFID System and related devices.

**The information contained in this section is important for the safe and reliable application of the V720-series Electromagnetic Inductive RFID System. You must read this section and understand the information contained before attempting to set up or operate a V720-series Electromagnetic Inductive RFID System.**

- 1 Intended Audience .....
- 2 General Precautions .....
- 3 Safety Precautions .....
- 4 Application Precautions .....
- 5 Correct Use .....
- 6 Applicable Standards .....
- 7 EN/IEC Standards .....
- 8 FCC Notices .....

## 1 Intended Audience

This manual is intended for the following personnel, who must also have knowledge of electrical systems (an electrical engineer or the equivalent).

- Personnel in charge of installing systems.
- Personnel in charge of designing systems.
- Personnel in charge of managing systems and facilities.

## 2 General Precautions

The user must operate the product according to the performance specifications described in the operation manuals.

Before using the product under conditions which are not described in the manual or applying the product to nuclear control systems, railroad systems, aviation systems, vehicles, combustion systems, medical equipment, amusement machines, safety equipment, and other systems, machines, and equipment that may have a serious influence on lives and property if used improperly, consult your OMRON representative.

Make sure that the ratings and performance characteristics of the product are sufficient for the systems, machines, and equipment, and be sure to provide the systems, machines, and equipment with double safety mechanisms.

This manual provides information for installing and operating the V720-series Electromagnetic Inductive RFID System. Be sure to read this manual before attempting to use the System and keep this manual close at hand for reference during operation.

 **WARNING** It is extremely important that a V720-series Electromagnetic Inductive RFID System be used for the specified purpose and under the specified conditions, especially in applications that can directly or indirectly affect human life. You must consult with your OMRON representative before applying the System to the above-mentioned applications.

## 3 Safety Precautions

 **WARNING** Always connect to a ground of 100  $\Omega$  or less when installing the System. Not connecting to a ground of 100  $\Omega$  or less may result in electric shock.

 **WARNING** Do not touch any of the terminals or terminal blocks while the power is being supplied. Doing so may result in electric shock.

 **WARNING** Do not attempt to take any unit apart or touch the inside while the power is being supplied. Doing so may result in electric shock.

## 4 Application Precautions

 **Caution** Be sure to observe the following precautions to ensure safety in installing or operating the System.

- Do not use the System in an environment subject to flammable, explosive, or corrosive gases.
- Do not attempt to take any Units apart, to repair any Units, or to modify any Units in any way.

- Be sure that all the mounting screws, terminal screws, and cable connector screws are tightened to the torque specified in the relevant manuals.
- Be sure that the items with locking devices are properly locked into place before using the System.
- Do not remove the ferrite core attached to the V720-H01-E.
- Be sure to observe all warnings, cautions, and safety precautions specified in the manual.

## 5 Correct Use

 **Caution** Do not install the V720-H01-E in the following locations:

- Locations subject to direct sunlight.
- Locations subject to condensation as the result of severe changes in temperature.
- Locations subject to corrosive or flammable gases.
- Locations subject to shock or vibration.

 **Caution** The RFID System operates at a frequency of 13.56 MHz to communicate with the Tags. Be sure to observe the following precautions to minimize the electrical noise that may be caused when the RFID System is placed near transceivers, motors, monitoring devices, or power supplies. Also confirm that the System is not affected by such noise in advance.

- Connect surrounding metallic devices to a ground of 100  $\Omega$  or less.
- Do not wire the lines of the RFID System alongside high-tension or power lines.
- Check the polarity of each terminal and make sure not to make mistakes in polarity.

 **Caution** Be sure to observe the following precaution when cleaning the V720-H01-E:

- Organic solvents may damage the paint coating on the casing or resin part of the product. Do not use paint thinner or any other organic solvent to clean the product.

## 6 Applicable Standards

The V720-H01-E conforms to the following standards:

- European Standard
  - EN 300 330 (1999)
  - ETS 300 683 (1997)
  - EN 60065
- FCC (USA)
  - FCC Part 15 Subpart C
- CCA (Canada)
  - CCA 210 Category I Equipment
- ARIB (Japan)
  - ARIB STD-T60

## 7 EN/IEC Standards

- In connection with EC unification, eighteen European countries will integrate their conventional safety standards into EN standards. When the EN stan-

dards come into effect, they will apply as the unified European standards in place of the conventional safety standards.

- EN standards are based on IEC standards. Therefore, machines that are exported to Europe from Asia or North America must satisfy EN standards. Otherwise, the machines must satisfy IEC standards if the machines do not fall under EN standards.
- The CE marking is provided by EC Directives. A product bearing a CE marking meets the safety standards specified by all relevant EC Directives. If the product is a machine, it must satisfy the EC Machinery Directive, Low-voltage Directive (LVD), and EMC requirements of the EC Directives. The product must satisfy the EMC and LVD requirements of the EC Directives, if the product is a home electronics appliance or office machine, and the R&TTE Directives as well as the EMC and LVD requirements of the EC Directives, if the product is a wireless or remote communications terminal. Machines bearing CE markings can be freely exported to European countries. In other words, a CE marking is the passport for export to Europe.
- EC Directives are provided for the purpose of European unification. Approximately 300 EC Directives have been passed. EC Directives for machines are called Machine Directives. According to the Machine Directives (EC Directive Document number 89/392/EEC), machines exported to Europe on and after January 1, 1995 must bear CE markings.
- EMC standards are for electro-magnetic compatibility. A machine must satisfy the EMC requirements of EC directives by taking countermeasures against EMI (electro-magnetic interference) and EMC (electro-magnetic susceptibility).
- R&TTE Directives are for wireless communications and remote communications terminals.

**Electromagnetic Inductive RFID System**

The V720-H01-E satisfies R&TTE Directive requirements. The following is a list of applicable V720-series products and corresponding standards.

Read Write Antenna	Standards	Remarks
V720-H01-E	EN 300 330 ETS 300 683 EN 60065	A ferrite core (TDK ZCAT2035-0930A-BK) is attached to the Antenna Cable. Do not remove the ferrite core.



**8 FCC Notices**

 **WARNING** Changes or modifications not expressly approved by the party responsible for compliance could void the user’s authority to operate the equipment.

Operation is subject to the following two conditions:

- (1) this device may not cause interference, and
- (2) this device must accept any interference, including interference that may cause undesired operation of the device.

# SECTION 1

## Characteristics

This section provides the characteristics of the components that make up the V720 System.

Characteristics .....

## Characteristics

The V720-series Electromagnetic Inductive RFID System is ideal for the construction of highly functional, long-distance wireless ID systems for material control and logistics.

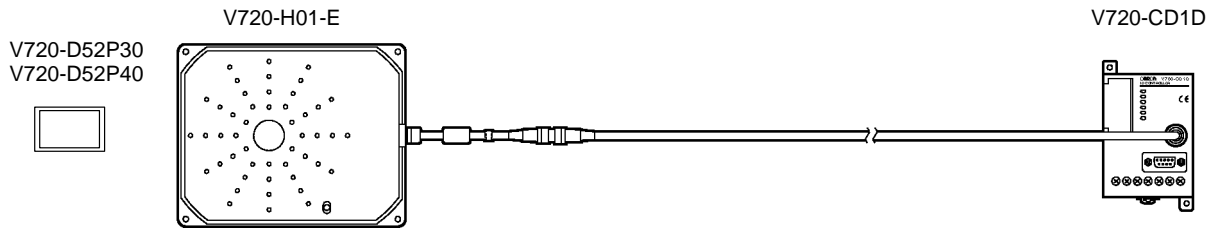

### V720-H01-E R/W Antenna

The V720-H01-E Read Write Antenna (hereon referred to as the “Antenna”) is a general-purpose antenna that is 250 by 200 mm in size. It can be used for communications between V720-D52P30 and V720-D52P40 Tags up to a maximum communications distance of 250 mm.

### V720-D52P30 and V720-D52P40 (RFID) Tags

The V720-D52P30 and V720-D52P40 RFID Tags (hereon referred to as “Tags”) are tags with a memory capacity of 44 bytes. Both Tags are card-shaped. The V720-D52P30 is laminated with clear PET, and the V720-D52P40 is molded with PET resin.

### Highly Functional RFID System

The RFID System operates in either multiple, simultaneous access mode or FIFO (first-in, first-out) read/write mode. In multiple, simultaneous access mode, if there is more than one Tag in the communications area, the RFID System reads and writes data from and to all the Tags at one time. In FIFO read/write mode, the RD-ID System reads and writes data to one Tag after another as they come into the communications area.

# SECTION 2

## Specifications and Performance

This section provides the specifications and performance characteristics of the components of the V720 System.

- 2-1 Read Write Antenna .....
- 2-1-1 Specifications .....
- 2-1-2 Dimensions .....
- 2-2 Tags .....
- 2-2-1 Specifications .....
- 2-2-2 Dimensions .....
- 2-2-3 Memory Map .....
- 2-3 Cable .....
- 2-3-1 Specifications .....
- 2-3-2 Dimensions .....

## 2-1 Read Write Antenna

### 2-1-1 Specifications

#### Basic Specifications

Item	V720-H01-E
Ambient operating temperature	-20 to 55°C (with no icing)
Ambient storage temperature	-35 to 65°C (with no icing)
Ambient operating humidity	35% to 85% (with no condensation)
Insulation resistance	20 MΩ min. (at 100 VDC) between rear plate and casing
Dielectric strength	1,000 VAC min. (50/60 Hz) between rear plate and casing for 1 minute (leakage current does not exceed 1 mA)
Degree of protection	IEC60529 IP40 (except connector)
Vibration resistance	Destruction: 10 to 150 Hz, 0.7-mm double amplitude at 50 m/s <sup>2</sup> in X, Y, and Z directions four times each for 8 minutes
Shock resistance	Destruction: 150 m/s <sup>2</sup> three times each in X, Y, and Z directions
Cable length	0.1 m (use up to 30.1 m of extension cable to connect to the Controller)
LED indicators	Power supply: Green Communications: Orange
Weight	Approx. 750 g

#### Communications Specifications

Item	V720-H01-E
Communications method	Electromagnetic induction
Communications frequency	13.56 MHz ± 7 kHz
Demodulation method	ASK
Communications range	V720-D52P30/V720-D52P40: typ. 250 mm (see note)

**Note** The communications range depends on many factors, such as tag orientation environment, and the presence of metallic objects. The range shown in the table is the typical communications range.

 **Caution** The Antenna is not water-resistant. Do not use the Antenna in places where it may come into contact with water.



### 2-1-2 Dimensions

V720-H01-E

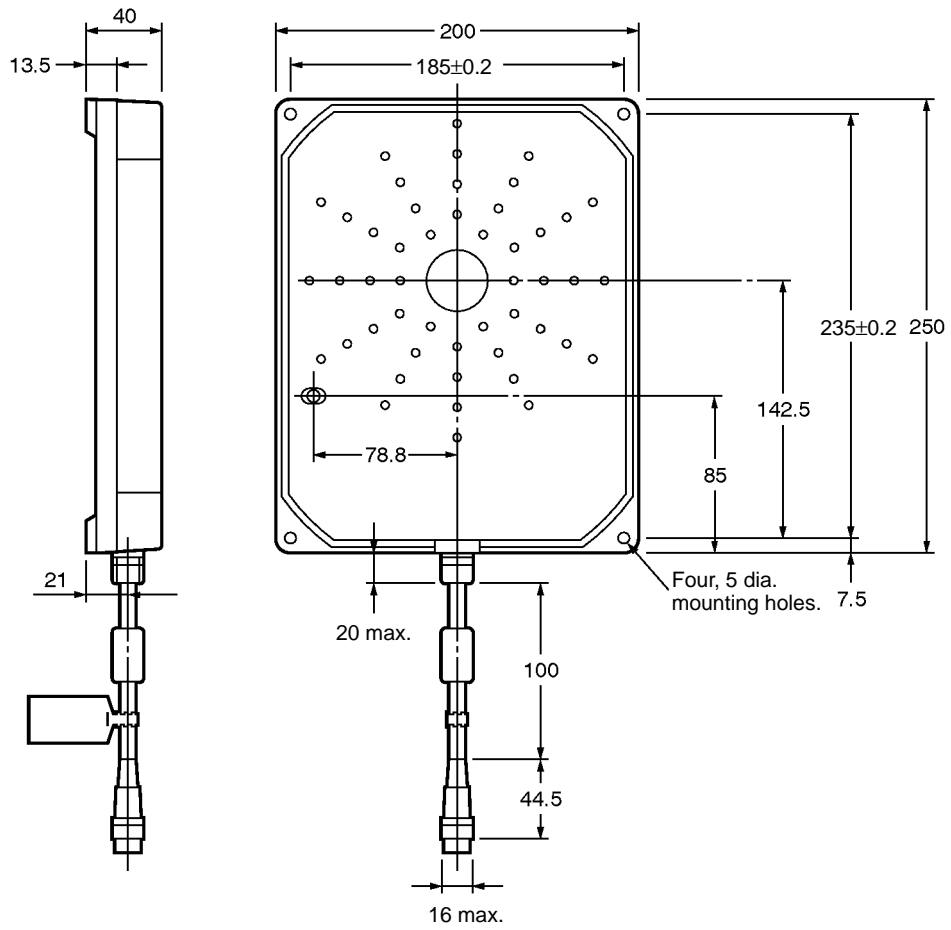

Casing material	PC/ASA resin
Rear panel material	Aluminium
Cable	PVC

## 2-2 Tags

### 2-2-1 Specifications

Item	Model	
	V720-D52P30	V720-D52P40
Memory capacity	44 bytes (User Memory area)	
Type of memory	EEPROM	
Data backup time	10 years	
Data writing times	100,000 times per address	
Ambient operating temperature	-10°C to 70°C	
Ambient storage temperature	-30°C to 70°C	
Degree of protection	IP67 (IEC60529)	
Vibration resistance	Destruction: 10 to 500 Hz, 1.5-mm double amplitude at 100 m/s <sup>2</sup> in X, Y, and Z directions ten times each for 11 minutes	
Shock resistance	Destruction: 500 m/s <sup>2</sup> in ±X, ±Y, and ±Z directions three times each (i.e., 18 times in total)	
Material	PET	
Weight	Approx. 2 g	Approx. 4 g

### 2-2-2 Dimensions

#### V720-D52P30

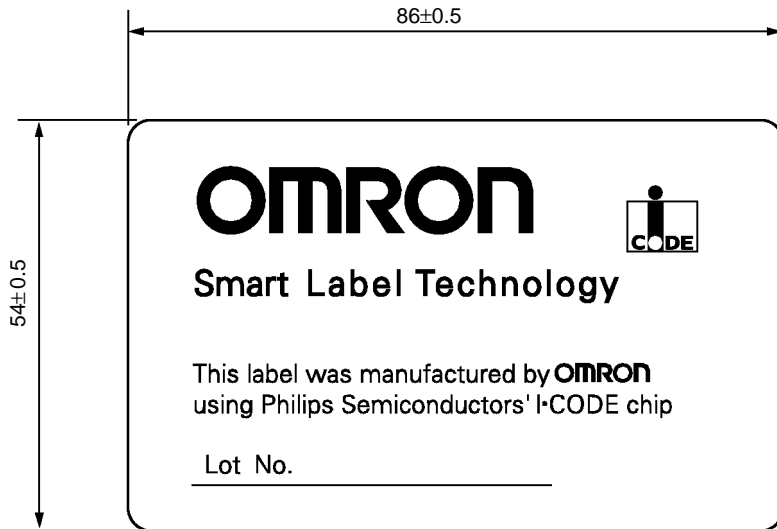

Thickness  
 IC part: 0.6 mm  
 Other: 0.4 mm

V720-D52P40



### 2-2-3 Memory Map

The V720-D52P30 and V720-D52P40 have (user) memory areas of 44 bytes (= 352 bits = 11 pages). Each page consists of 4 bytes (1 page = 32 bits). A page is the smallest access unit with regard to reading and writing. In addition to user memory, Tags have a system area that contains a serial number, the family code, the application ID, and Lock-settings information.

Page (hexadecimal)	Byte 0	Byte 1	Byte 2	Byte 3	Data
00H	In use	In use	In use	In use	11 pages (44 bytes) (352 bits)
01H	In use	In use	In use	In use	
:					
:					
:					
0AH	In use	In use	In use	In use	

## 2-3 Cable

### 2-3-1 Specifications

Item	V720-A4□
Number of conductors	10
Insulation resistance	5 MΩ min. (at 500 VDC) between conductor and shield
Dielectric strength	500 VAC 1 min.
Maximum operating temperature	80°C
Remarks	Connectors are not water resistant.

### 2-3-2 Dimensions

V720-A4□

Item	Model					
	V720-A40	V720-A41	V720-A42	V720-A43	V720-A44	V720-A45
Length	Approx. 2 m	Approx. 3 m	Approx. 5 m	Approx. 10 m	Approx. 20 m	Approx. 30 m
Weight	Approx. 150 g	Approx. 220 g	Approx. 360 g	Approx. 700 g	Approx. 1,350 g	Approx. 2,000 g
L1	2,000	3,000	5,000	10,000	20,000	30,000

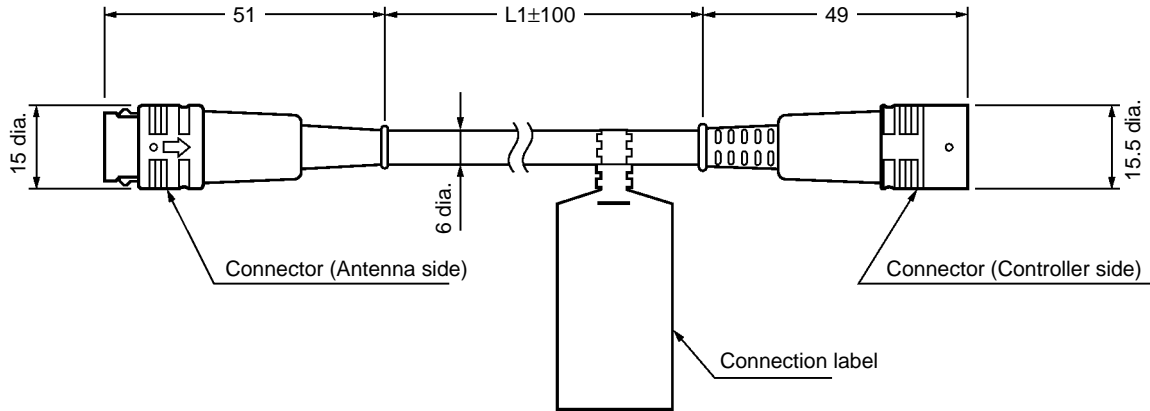

# SECTION 3

## Installation

This section provides installation information for the V720 System.

- 3-1 Installation of Antenna .....
- 3-1-1 Installation Environment .....
- 3-1-2 Mounting the Antenna .....
- 3-2 Installation of Tag .....
- 3-2-1 Installation Environment .....
- 3-2-2 Mounting the Tag .....

## 3-1 Installation of Antenna

### 3-1-1 Installation Environment

#### Installation Location

Do not install the Antenna in the following locations.

- The ambient temperature is not within a range between  $-20^{\circ}\text{C}$  and  $55^{\circ}\text{C}$  or locations with radical temperature changes resulting in condensation.
- The humidity is not within a range between 35% and 85%.
- There is corrosive gas, flammable gas, dust, salt, or metal powder.
- The Antenna will be subjected to direct vibration or shock.
- Water, oil, or chemical will be sprayed onto the Antenna.

#### Countermeasures Against Noise

Ambient noise can cause the communications range of the Antenna to drop.

Ambient noise can be reduced by taking the following countermeasures.

#### **Power Lines and High-tension Lines**

Do not wire the Antenna cable along with high-tension lines or power lines. Keep the Antenna cable as far away as possible from them.

#### **Inverters, Motors, and Other Driving Mechanisms**

Be sure to ground the frames of driving mechanisms and keep them as far away as possible from the Antenna.

#### **Switching Power Supplies**

Be sure to ground switching power supplies and keep them as far away as possible from the Antenna.

**Note** Keep the above in mind before installing the Antenna. Before the Antenna is put in actual use, be sure to conduct enough tests of the Antenna.

### 3-1-2 Mounting the Antenna

Be sure to attach the provided bracket to the Antenna and mount the Antenna with four M4 screws with spring washers and flat washers as shown below.

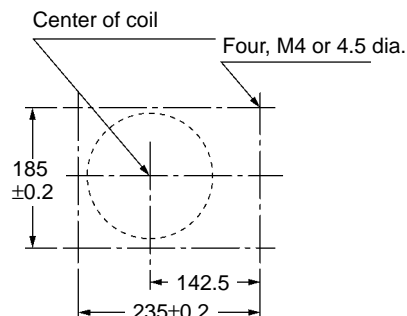
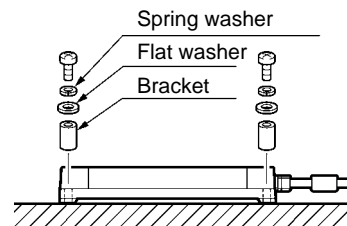

#### **Mounting Location**

If the Antenna is mounted on a metallic surface, the communications distance will be 10% less than the specified maximum communications distance. Take this into consideration when mounting.

**Multiple Antennas**

When mounting two or more Antennas in close proximity to each other, ensure that their communications areas do not overlap. For more details, refer to *4-1 Communications Areas*. As a rough guide, when mounting Antennas in parallel or facing each other, ensure that the Antennas are separated by at least the dimensions shown below.

**3-2 Installation of Tag****3-2-1 Installation Environment**

Do not install the V720-D52P30 or V720-D52P40 Tags in the following locations.

- Locations subject to corrosive gas, flammable gas, oil, chemicals, organic solvents, salt, dust, or metal powder.
- Inside microwave ovens.

**3-2-2 Mounting the Tag**

Although there are no special rules, abide by the following.

- Do not cut or open holes in the Tag.
- Do not impose excessive force on the Tag.

**Mounting Direction**

- Operation at the specified maximum communications distance is possible if the face of the tag is mounted so that it is parallel to the face of the Antenna.
- If the tag is mounted at an angle, the communications distance will be less. For details of the relationship between the orientation of the tag and the communications distance, refer to *4-2 Influence of Tag Angle*.
- The communications characteristics of the Tag do not depend on the front/back orientation.

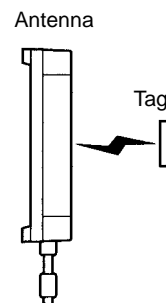
**Mounting Location**

The communications may be reduced by the kind and shape of material on which the Tag is mounted. Refer to *4-3 Relationship Between Tag and Metallic Objects* for details of mounting location effects.

**Multiple Tags**

If two or more Tags are used on top of each other or in contact with each other, interference between the Tags will cause the communications distance to decrease, and part or all of the Tags may become unreadable. When mounting Tags in close proximity, perform tests beforehand to check for interference.

# SECTION 4

## Reference Data

This section provides reference data relating to V720 communications areas.

- 4-1 Communications Areas .....
- 4-2 Influence of Tag Angle .....
- 4-3 Effects of Materials on Tags .....



### 4-1 Communications Areas

The typical communications area of the V720-H01-E is shown below. The actual communications area will vary with the mounting environment and conditions.

The following diagram shows the communications area for a plane that goes through the center of the V720-H01-E and is perpendicular to it.

Communications Area Graph (V720-H01-E to V720-D52P30/V720-D52P40)

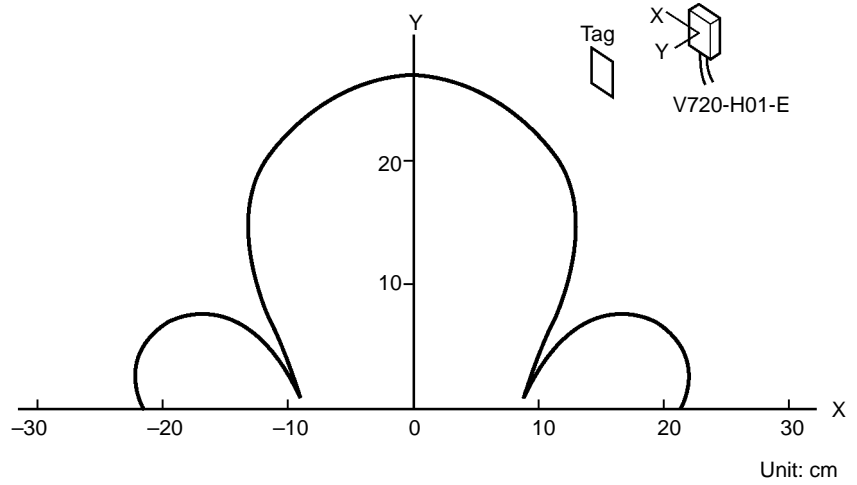

## 4-2 Influence of Tag Angle

The maximum communications range between the Antenna and Tag will be available if the face of the Antenna and the face of the Tag are parallel to each other. The communications range will be reduced if the Tag is mounted at an angle. Take the angle of the Tag into consideration when mounting.

For reference, the relationship between the Tag angle and the communications range is illustrated in the graph below. The horizontal axis represents the angle between the face of the Antenna and the Tag with 0° representing the state where the faces are parallel. The vertical axis represents the relative communications range from when the angle is 0° and the communications range is 100% (i.e., the percentage reduction in communications range).

### V720-H01-E to V720-D52P30/V720-D52P40

#### Communications Range vs. Tag Angle

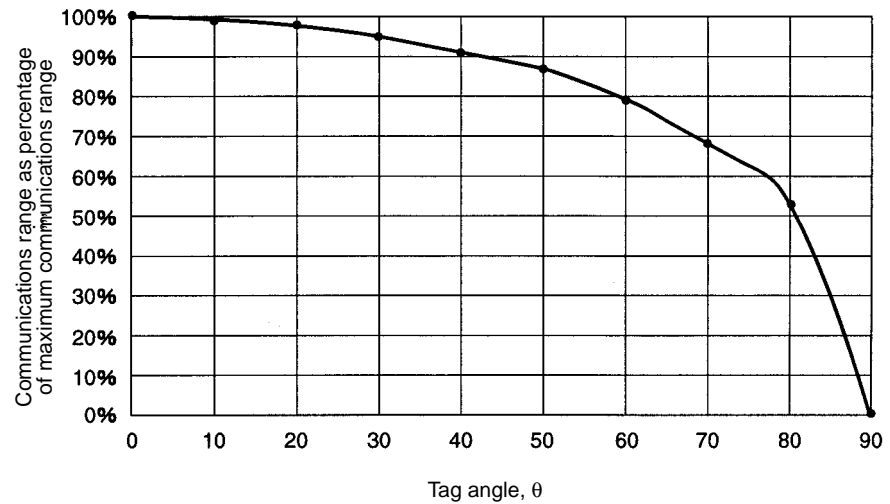

#### Test Setup

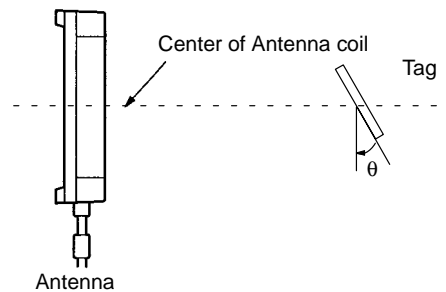

### 4-3 Effects of Materials on Tags

Take into consideration the effects of the mounting location when mounting the Tag. Communications range may be reduced if the Tag is near certain objects. The extent to which the distance will decrease depends on the actual material and its shape. Check the back of the Tag for the effects of metal and resin objects.

#### V720-H01-E to V720-D52P30/V720-D52P40

##### Effect of Metal Objects

The graph below shows the percentage reduction in communications range when a metal object is mounted behind the Tag. The horizontal axis represents the distance between the metallic plate and the Tag. The vertical axis represents the percentage decrease in communications range, where communications range with no metal object interference is taken to be 100%.

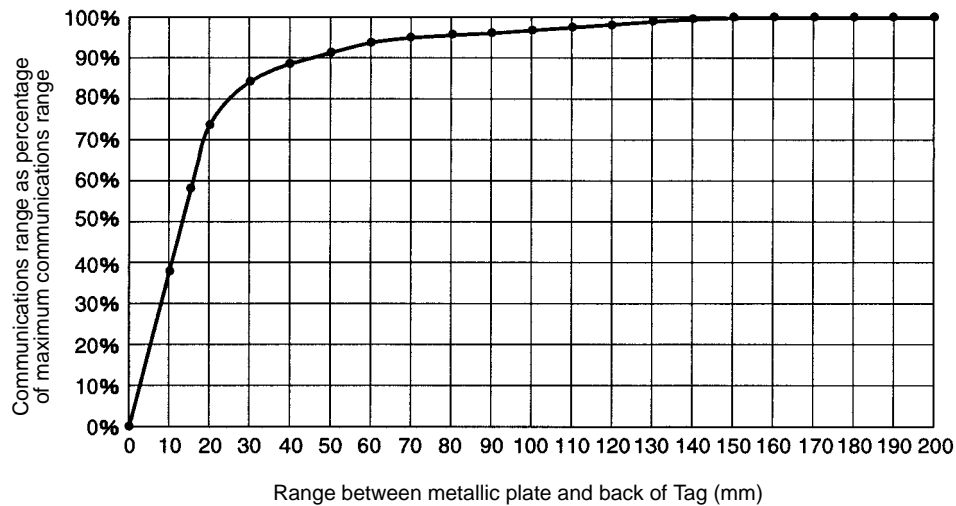

##### Effect of Resin Objects

The following table shows the results of measuring the communications range when the Tag is mounted to a resin object. The extent to which the distance will decrease depends on the actual resin material and its shape.

Material (shape)	Communications range
Bakelite (100 mm x 100 mm x 5 mm)	Typ. 19 cm
Acrylic resin (100 mm x 100 mm x 2 mm)	Typ. 22 cm
Polyethylene (100 mm x 100 mm x 2 mm)	Typ. 24 cm

**Test Setup**

**Metal Object**

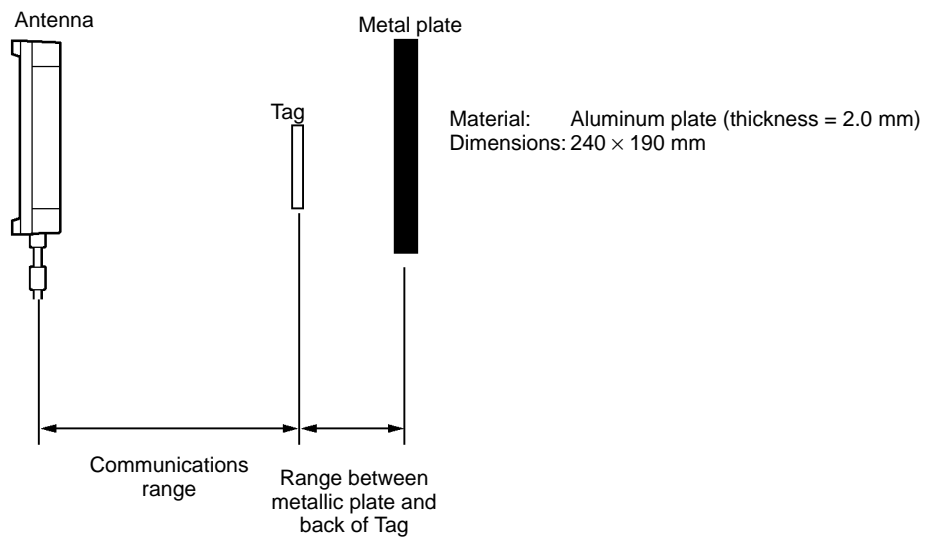

**Resin Object**

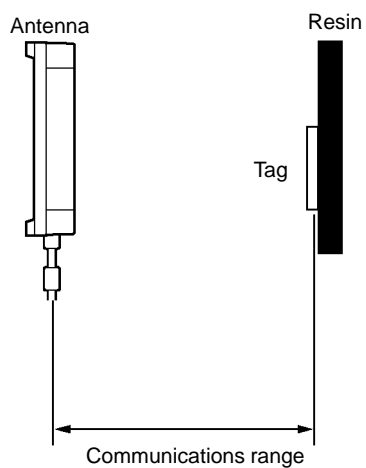



**OMRON Corporation**  
**Card Business Promotion Division**  
14th Fl., Gate City Osaki West Tower  
1-11-1 Osaki, Shinagawa-ku,  
Tokyo 141-0032 Japan  
Tel: (81)3-5435-2016/Fax: (81)3-5435-2017

***Regional Headquarters***

**OMRON EUROPE B.V.**  
Wegalaan 67-69, NL-2132 JD Hoofddorp  
The Netherlands  
Tel: (31)2356-81-300/Fax: (31)2356-81-388

**OMRON ELECTRONICS, INC.**  
1 East Commerce Drive, Schaumburg, IL 60173  
U.S.A.  
Tel: (1)847-843-7900/Fax: (1)847-843-8568

**OMRON ASIA PACIFIC PTE. LTD.**  
55 Ubi Arenwel #05-01  
408935 Singapore  
Tel: (65)5476789/Fax: (65)5476766

**OCE: OMRON (CHINA) CO., LTD.**  
21F Beijing East Ocean Centre,  
No. 24A Jian Guo Men Wai Da Jie,  
Chao Yang District, Beijing 100022  
China  
Tel: (86)10-6515-5778 to 5782  
Fax: (86)10-6515-5801 to 5802

Up-to-date information on RFID Systems can be accessed at OMRON's web site at  
<http://www.omron.com/card/rfid>

**Authorized Distributor:**



## Artisan Technology Group is your source for quality new and certified-used/pre-owned equipment

- FAST SHIPPING AND DELIVERY
- TENS OF THOUSANDS OF IN-STOCK ITEMS
- EQUIPMENT DEMOS
- HUNDREDS OF MANUFACTURERS SUPPORTED
- LEASING/MONTHLY RENTALS
- ITAR CERTIFIED SECURE ASSET SOLUTIONS

### SERVICE CENTER REPAIRS

Experienced engineers and technicians on staff at our full-service, in-house repair center

### *InstraView*<sup>SM</sup> REMOTE INSPECTION

Remotely inspect equipment before purchasing with our interactive website at [www.instraview.com](http://www.instraview.com) ↗

### WE BUY USED EQUIPMENT

Sell your excess, underutilized, and idle used equipment. We also offer credit for buy-backs and trade-ins. [www.artisanng.com/WeBuyEquipment](http://www.artisanng.com/WeBuyEquipment) ↗

### LOOKING FOR MORE INFORMATION?

Visit us on the web at [www.artisanng.com](http://www.artisanng.com) ↗ for more information on price quotations, drivers, technical specifications, manuals, and documentation

**Contact us:** (888) 88-SOURCE | [sales@artisanng.com](mailto:sales@artisanng.com) | [www.artisanng.com](http://www.artisanng.com)