



Artisan Technology Group is your source for quality new and certified-used/pre-owned equipment

- FAST SHIPPING AND DELIVERY
- TENS OF THOUSANDS OF IN-STOCK ITEMS
- EQUIPMENT DEMOS
- HUNDREDS OF MANUFACTURERS SUPPORTED
- LEASING/MONTHLY RENTALS
- ITAR CERTIFIED SECURE ASSET SOLUTIONS

SERVICE CENTER REPAIRS

Experienced engineers and technicians on staff at our full-service, in-house repair center

*InstraView*SM REMOTE INSPECTION

Remotely inspect equipment before purchasing with our interactive website at www.instraview.com ↗

WE BUY USED EQUIPMENT

Sell your excess, underutilized, and idle used equipment. We also offer credit for buy-backs and trade-ins. www.artisanng.com/WeBuyEquipment ↗

LOOKING FOR MORE INFORMATION?

Visit us on the web at www.artisanng.com ↗ for more information on price quotations, drivers, technical specifications, manuals, and documentation

Contact us: (888) 88-SOURCE | sales@artisanng.com | www.artisanng.com

Data processing unit for NMOS linear image sensor C8799

Data processing unit with USB interface



C8799 is a data processing unit that converts video signals from an NMOS image sensor driver circuit into digital signals and transfers them to a PC. The USB interface allows easy connection to a PC for high-speed data communications at 12 Mbps.

Features

- Built-in 12-bit A/D converter
- Adjustable data rate (5 MHz Max.)
- Internal memory: 1 mega-word
- Interface of computer: USB 1.1
- Simultaneous measurements using multiple units

Applications

- Spectrophotometry
- Position measurement

Absolute maximum ratings (Ta=25 °C)

Parameter	Symbol	Value	Unit
Digital power supply	V _D	+7	V
Analog power supply	V _A	±18	V
Operating temperature	T _{opr}	0 to +50 *1	°C
Storage temperature	T _{stg}	0 to +60 *1	°C

*1: No condensation

Specifications

Parameter	Remark	Specification
Supply voltage	+5 V	*2
	+15 V	*2
	-15 V	
Video input signal	*3	0 to 10 V
Control output signal (START)	*4	Positive logic
Synchronized output signal (CLK)	*5	16 MHz, 8 MHz, 4 MHz, 2 MHz, 1 MHz, 500 kHz, 250 kHz, 125 kHz, 62.5 kHz
A/D resolution		12 bit
Data rate	*6	5 MHz (Max.)
Internal memory		1 mega-word
Interface of computer		USB 1.1
Compatible OS	*7	Windows 98, Windows 2000, Windows XP

*2: Tentative data

*3: C8799-01 compatible with 0 to 5 V supply is also available.

*4: Pulse width and interval are adjustable.

*5: Setting is selectable.

*6: Data rate equals the CLK frequency divided by the number of CLK pulses generated in an NMOS driver circuit for forming pixels.

*7: Correct operation on OS (operating system) has been verified, but please note that operation has not been verified on all PC models.

■ Block diagram

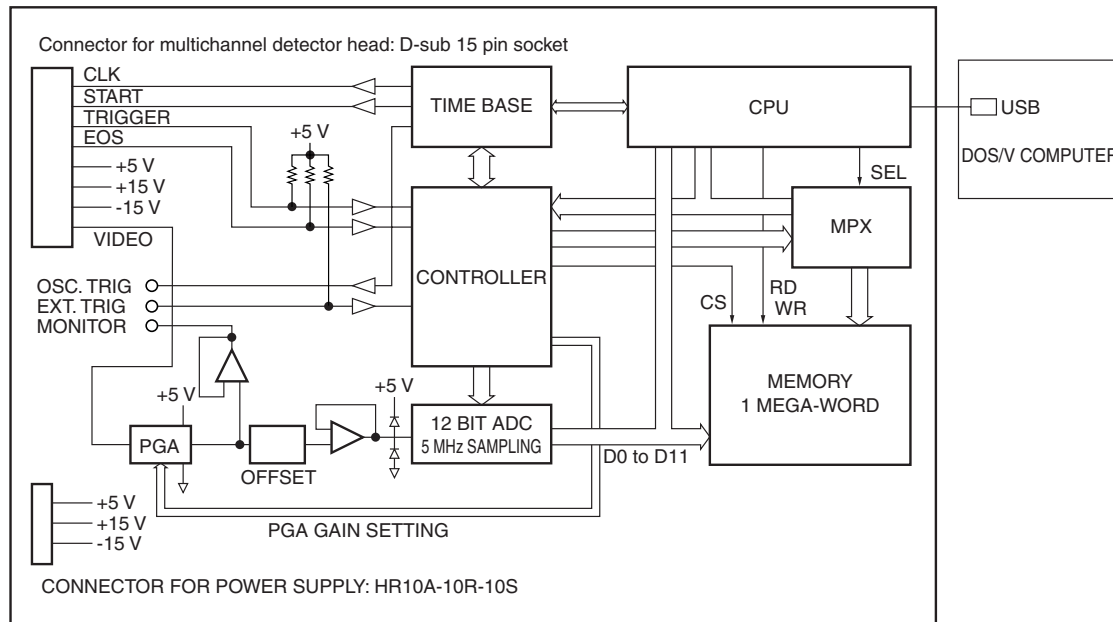

DATA PROCESSING UNIT C8799

KACC00173EA

■ Timing chart (external trigger setting)

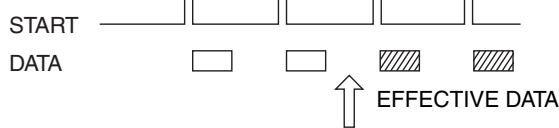
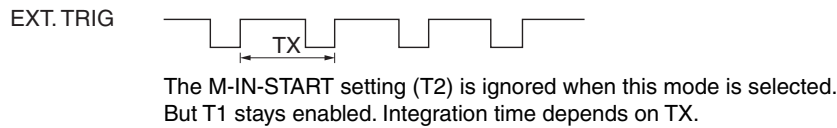
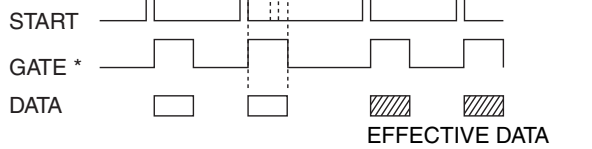
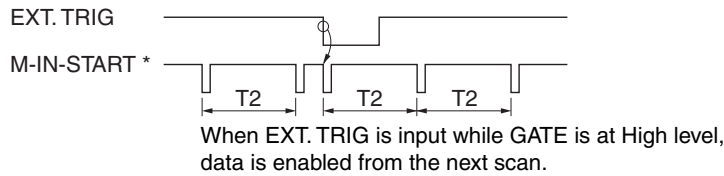

KACC00176EA

* Internal signal

■ Timing chart (accumulation setting)

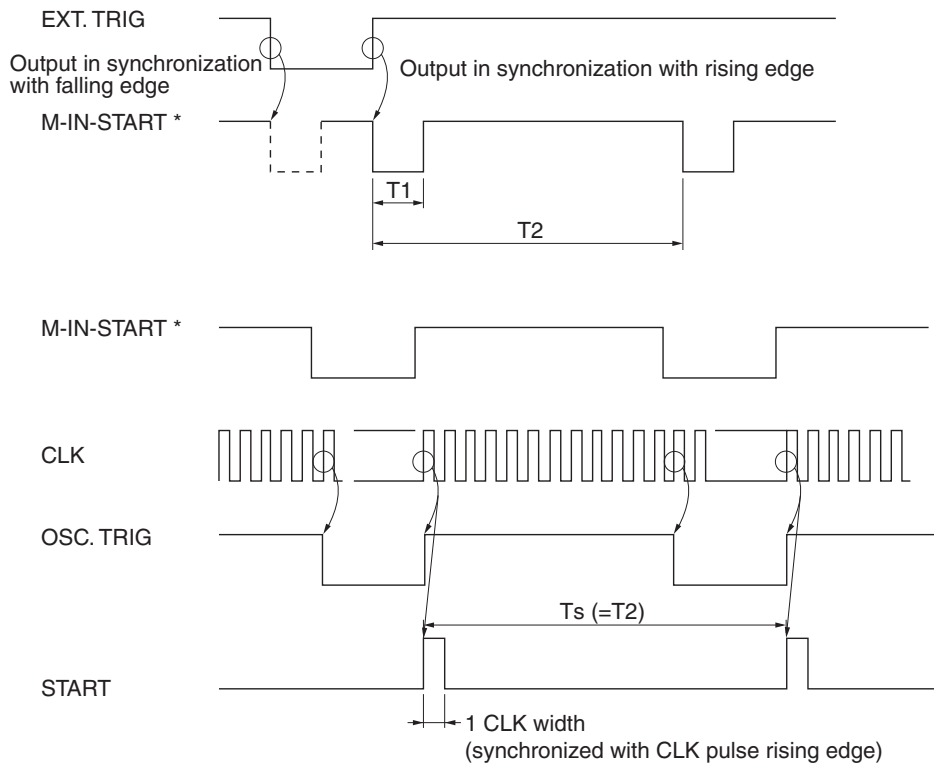

* Internal signal

KACCC0177EA

■ Dimensional outline (unit: mm)

I/F CONNECTOR FOR MULTICHANNEL
DETECTOR HEAD: D-sub 15 PIN SOCKET TYPE

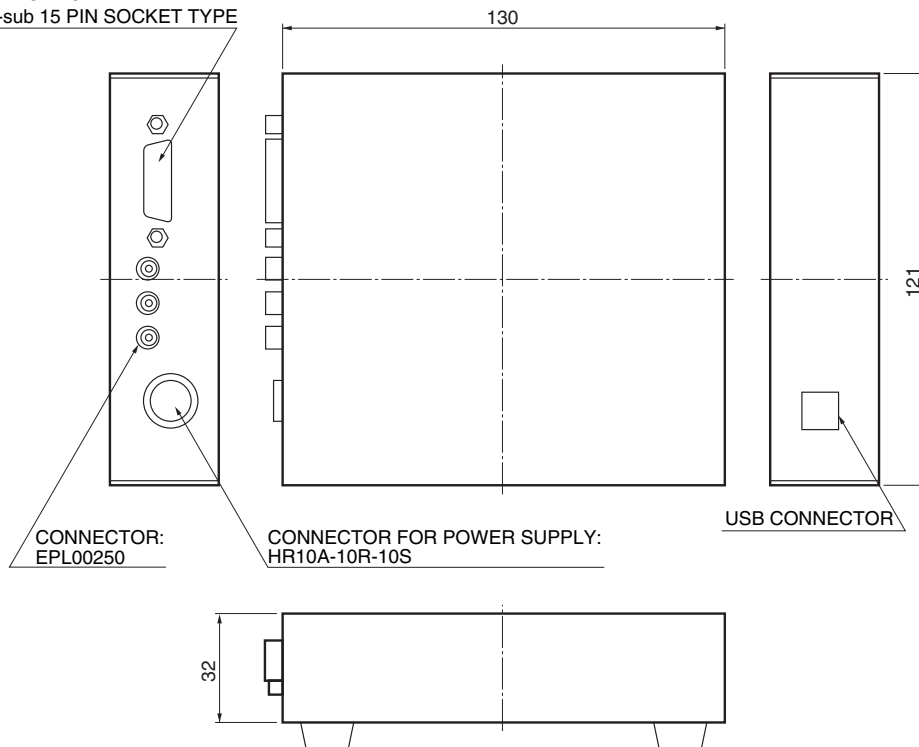

KACCA0114EA

■ Pin connection of "SIGNAL I/O" connector

<Connector for multichannel detector head I/F>
(15-pin D-sub connector)

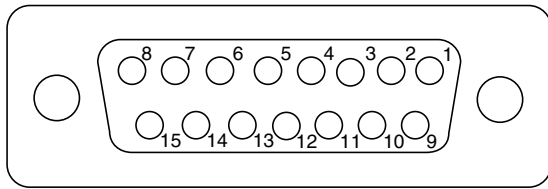

KACCC0069EA

Pin No.	Terminal name	I/O	Content
1	NC		No connection
2	VIDEO	I	Video signal
3	+15 V	O	+15 V supply line
4	-15 V	O	-15 V supply line
5	+5 V	O	+5 V supply line
6	START	O	MCD reset signal
7	CLK	O	MCD synchronization signal
8	EOS	I	Sensor end-of-scan signal
9	A. GND		Analog ground
10	A. GND		Analog ground
11	NC		No connection
12	D. GND		Digital ground
13	D. GND		Digital ground
14	D. GND		Digital ground
15	TRIGGER	I	A/D conversion timing

<Supply connector>
R-circle type connector
Made by HIROSE: HR10A-10R-10S

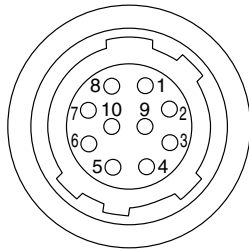

KACCC0178EA

Pin No.	Terminal name	I/O	Content
1	+15 V	I	+15 V supply line
2	A. GND		Analog ground
3	-15 V	I	-15 V supply line for MCD
4	A. GND		Analog ground
5	+5 V	I	+5 V supply line
6	D. GND		Digital ground
7	+5 V	I	+5 V supply line for MCD
8	D. GND		Digital ground
9	NC		No connection
10	NC		No connection

Note) MCD: Multichannel Detector Head

■ Connection example for data processing unit (C8799) to peripheral units

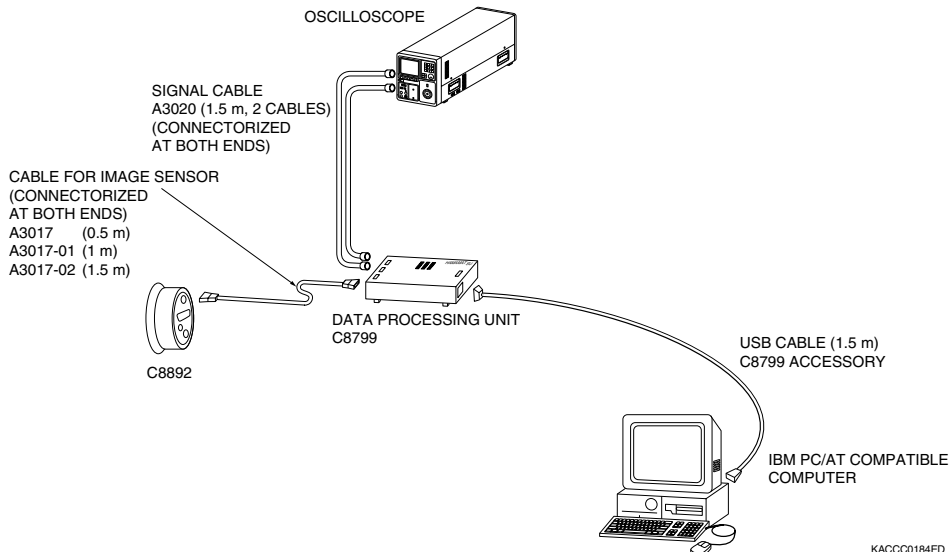

KACCC0184ED

HAMAMATSU

Information furnished by HAMAMATSU is believed to be reliable. However, no responsibility is assumed for possible inaccuracies or omissions. Specifications are subject to change without notice. No patent rights are granted to any of the circuits described herein. ©2002 Hamamatsu Photonics K.K.

HAMAMATSU PHOTONICS K.K., Solid State Division

1126-1 Ichino-cho, Hamamatsu City, 435-8558 Japan, Telephone: (81) 053-434-3311, Fax: (81) 053-434-5184, <http://www.hamamatsu.com>

U.S.A.: Hamamatsu Corporation: 360 Foothill Road, P.O.Box 6910, Bridgewater, N.J. 08807-0910, U.S.A., Telephone: (1) 908-231-0960, Fax: (1) 908-231-1218

Germany: Hamamatsu Photonics Deutschland GmbH: Arzbergerstr. 10, D-82211 Herrsching am Ammersee, Germany, Telephone: (49) 08152-3750, Fax: (49) 08152-2658

France: Hamamatsu Photonics France S.A.R.L.: 8, Rue du Saule Trapu, Parc du Moulin de Massy, 91882 Massy Cedex, France, Telephone: 33-(1) 69 53 71 00, Fax: 33-(1) 69 53 71 10

United Kingdom: Hamamatsu Photonics UK Limited: 2 Howard Court, 10 Tewin Road, Welwyn Garden City, Hertfordshire AL7 1BW, United Kingdom, Telephone: (44) 1707-294888, Fax: (44) 1707-325777

North Europe: Hamamatsu Photonics Norden AB: Smidesvägen 12, SE-171 41 Solna, Sweden, Telephone: (46) 8-509-031-00, Fax: (46) 8-509-031-01

Italy: Hamamatsu Photonics Italia S.R.L.: Strada della Moia, 1/E, 20020 Arese, (Milano), Italy, Telephone: (39) 02-935-81-733, Fax: (39) 02-935-81-741

Cat. No. KACC1078E02
Nov. 2002 DN



Artisan Technology Group is your source for quality new and certified-used/pre-owned equipment

- FAST SHIPPING AND DELIVERY
- TENS OF THOUSANDS OF IN-STOCK ITEMS
- EQUIPMENT DEMOS
- HUNDREDS OF MANUFACTURERS SUPPORTED
- LEASING/MONTHLY RENTALS
- ITAR CERTIFIED SECURE ASSET SOLUTIONS

SERVICE CENTER REPAIRS

Experienced engineers and technicians on staff at our full-service, in-house repair center

*InstraView*SM REMOTE INSPECTION

Remotely inspect equipment before purchasing with our interactive website at www.instraview.com ↗

WE BUY USED EQUIPMENT

Sell your excess, underutilized, and idle used equipment. We also offer credit for buy-backs and trade-ins. www.artisanng.com/WeBuyEquipment ↗

LOOKING FOR MORE INFORMATION?

Visit us on the web at www.artisanng.com ↗ for more information on price quotations, drivers, technical specifications, manuals, and documentation

Contact us: (888) 88-SOURCE | sales@artisanng.com | www.artisanng.com