



## Artisan Technology Group is your source for quality new and certified-used/pre-owned equipment

- FAST SHIPPING AND DELIVERY
- TENS OF THOUSANDS OF IN-STOCK ITEMS
- EQUIPMENT DEMOS
- HUNDREDS OF MANUFACTURERS SUPPORTED
- LEASING/MONTHLY RENTALS
- ITAR CERTIFIED SECURE ASSET SOLUTIONS

### SERVICE CENTER REPAIRS

Experienced engineers and technicians on staff at our full-service, in-house repair center

### *InstraView*<sup>SM</sup> REMOTE INSPECTION

Remotely inspect equipment before purchasing with our interactive website at [www.instraview.com](http://www.instraview.com) ↗

### WE BUY USED EQUIPMENT

Sell your excess, underutilized, and idle used equipment. We also offer credit for buy-backs and trade-ins. [www.artisanng.com/WeBuyEquipment](http://www.artisanng.com/WeBuyEquipment) ↗

### LOOKING FOR MORE INFORMATION?

Visit us on the web at [www.artisanng.com](http://www.artisanng.com) ↗ for more information on price quotations, drivers, technical specifications, manuals, and documentation

**Contact us:** (888) 88-SOURCE | [sales@artisanng.com](mailto:sales@artisanng.com) | [www.artisanng.com](http://www.artisanng.com)



115817-P1  
Rev E, 7/98  
Instruction Manual

# MKS Type 270D High Accuracy Signal Conditioner

---

Six Shattuck Road  
Andover, MA 01810-2449  
(800) 227-8766 or (978) 975-2350

Fax: (978) 975-0093  
E-mail: [mks@mksinst.com](mailto:mks@mksinst.com)  
Web site: <http://www.mksinst.com>



## WARRANTY

### Type 270D Equipment

MKS Instruments, Inc. (**MKS**) warrants that the equipment described above (the "equipment") manufactured by **MKS** shall be free from defects in materials and workmanship for a period of one year from date of shipment and will for a period of two years from the date of shipment, correctly perform all date-related operations, including without limitation accepting data entry, sequencing, sorting, comparing, and reporting, regardless of the date the operation is performed or the date involved in the operation, provided that, if the equipment exchanges data or is otherwise used with equipment, software, or other products of others, such products of others themselves correctly perform all date-related operations and store and transmit dates and date-related data in a format compatible with **MKS** equipment. **THIS WARRANTY IS MKS' SOLE WARRANTY CONCERNING DATE-RELATED OPERATIONS.**

For the period commencing with the date of shipment of this equipment and ending one year later in the case of defects in materials and workmanship, but two years later in the case of failure to comply with the date-related operations warranty, **MKS** will, at its option, either repair or replace any part which is defective in materials or workmanship or with respect to the date-related operations warranty without charge to the purchaser. The foregoing shall constitute the exclusive and sole remedy of the purchaser for any breach by **MKS** of this warranty.

The purchaser, before returning any equipment covered by this warranty, which is asserted to be defective by the purchaser, shall make specific written arrangements with respect to the responsibility for shipping the equipment and handling any other incidental charges with the **MKS** sales representative or distributor from which the equipment was purchased or, in the case of a direct purchase from **MKS**, with the **MKS** home office in Andover, Massachusetts, USA.

This warranty does not apply to any equipment which has not been installed and used in accordance with the specifications recommended by **MKS** for the proper and normal use of the equipment. **MKS** shall not be liable under any circumstances for indirect, special, consequential, or incidental damages in connection with, or arising out of, the sale, performance, or use of the equipment covered by this warranty.

**MKS** recommends that all **MKS** pressure and flow products be calibrated periodically (typically every 6 to 12 months) to ensure accurate readings. When a product is returned to **MKS** for this periodic re-calibration it is considered normal preventative maintenance not covered by any warranty.

**THIS WARRANTY IS IN LIEU OF ALL OTHER RELEVANT WARRANTIES, EXPRESSED OR IMPLIED, INCLUDING THE IMPLIED WARRANTY OF MERCHANTABILITY AND THE IMPLIED WARRANTY OF FITNESS FOR A PARTICULAR PURPOSE, AND ANY WARRANTY AGAINST INFRINGEMENT OF ANY PATENT.**

# **MKS Type 270D High Accuracy Signal Conditioner**

*Copyright © 1998 by MKS Instruments, Inc.*

*All rights reserved. No part of this work may be reproduced or transmitted in any form or by any means, electronic or mechanical, including photocopying and recording, or by any information storage or retrieval system, except as may be expressly permitted in writing by MKS Instruments, Inc.*

*Printed in the United States of America*

Baratron® is a registered trademark of MKS Instruments, Inc., Andover, MA

## Table of Contents

Safety Information.....	1
Symbols Used in This Instruction Manual.....	1
Symbols Found on the Unit .....	2
Safety Procedures and Precautions .....	3
Sicherheitshinweise .....	5
In dieser Betriebsanleitung vorkommende Symbole .....	5
Am Gerät angebrachte Symbole.....	6
Sicherheitsvorschriften und Vorsichtsmaßnahmen.....	7
Informations relatives à la sécurité.....	9
Symboles utilisés dans ce manuel d'utilisation .....	9
Symboles apparaissant sur l'appareil .....	10
Mesures de sécurité et mises en garde .....	11
Información sobre seguridad.....	13
Símbolos usados en el manual de instrucciones.....	13
Símbolos que aparecen en la unidad.....	14
Procedimientos y precauciones de seguridad .....	15
Chapter One: General Information.....	17
Introduction .....	17
How This Manual is Organized.....	18
Manual Conventions .....	18
Terminology.....	18
Customer Support.....	19
Chapter Two: Installation .....	21
How to Unpack the Type 270 Instrument.....	21
Parts Checklist .....	21
Companion Products.....	23
Product Location and Requirements.....	24
General Requirements .....	24

Chapter Three: Overview .....	25
Front Panel Controls .....	25
Display .....	25
The $\times 10^{-3}$ and $\times 10^{-6}$ Lamps .....	25
SENSOR RANGE Selector Switch.....	26
Display Units Selector Switch.....	26
RANGE SELECT Switch .....	26
SENSOR ZERO Controls .....	26
RESPONSE Toggle Switch .....	27
HEATER Lamp .....	27
HEATER Toggle Switch .....	27
POWER Switch.....	27
Rear Panel Controls.....	28
REMOTE Connector .....	28
ACCESSORY Connector .....	29
HEAD Connector.....	30
Power Entry Module.....	30
BCD Connector .....	31
BCD Interface Signals.....	34
<u>REMOTE DISPLAY HOLD</u> Line.....	34
Data Ready Line .....	34
Enable Lines .....	34
OVERRANGING Output on the $5\frac{1}{2}$ Digit Unit (270-5).....	35
MULTIPLEX Connector .....	36
Chapter Four: Operation .....	37
How to Configure the 270 Instrument.....	37
How to Change the Line Voltage Selection .....	40
How to Select the Range Setting Remotely.....	41
Additional Procedures for the 0.1 Torr Sensors.....	42
How to Adjust the Zero on the 0.1 Torr Full Scale Sensor.....	42
Using a Low Range Pressure Sensor with the Remote Zero Option.....	43
Chapter Five: Maintenance and Troubleshooting.....	45

General .....	45
How to Replace the Fuses .....	46
Troubleshooting.....	48
Test A: Localizing the Malfunction to the Cable or the Electronics Unit.....	50
Test B: Localizing Malfunctions to the Electronics Unit.....	52
How to Recalibrate the 270 Unit .....	52
Appendix A: Product Specifications.....	53
Index.....	55





## List of Figures and Tables

### *Figures*

Figure 1: Front Panel of the 270-4 Unit .....	25
Figure 2: Rear Panel of the 270-4 Unit .....	28
Figure 3: Interconnection Cables .....	37
Figure 4: Sensor Cable Plus Two Resistors .....	51

### *Tables*

Table 1: Definition of Symbols Found on the Unit .....	2
Tabelle 2: Definitionen der am Gerät angebrachten Symbole .....	6
Tableau 3: Définition des symboles apparaissant sur l'appareil .....	10
Tabla 4: Definición de los símbolos que aparecen en la unidad .....	14
Table 5: RESPONSE Switch Settings .....	27
Table 6: REMOTE Connector (J402) Pinout .....	28
Table 7: ACCESSORY Connector (J401) Pinout .....	29
Table 8: HEAD Connector (J403) Pinout .....	30
Table 9: BCD Connector Pinout for Type 270-4 (4½ digit display) .....	31
Table 10: BCD Connector Pinout for the Type 270-5 .....	33
Table 11: MULTIPLEX Connector (J405) Pinout .....	36
Table 12: Remote Range Logic Levels .....	41
Table 13: Fuses for the Type 270 Instrument .....	46
Table 14: Sensor Cable Voltage Check .....	50
Table 15: Electronics Unit Voltage Check .....	52



## Safety Information

### Symbols Used in This Instruction Manual

Definitions of WARNING, CAUTION, and NOTE messages used throughout the manual.

---

**Warning**  The **WARNING** sign denotes a hazard. It calls attention to a procedure, practice, condition, or the like, which, if not correctly performed or adhered to, could result in injury to personnel.

---

---

**Caution**  The **CAUTION** sign denotes a hazard. It calls attention to an operating procedure, practice, or the like, which, if not correctly performed or adhered to, could result in damage to or destruction of all or part of the product.

---

---

**Note**  The **NOTE** sign denotes important information. It calls attention to a procedure, practice, condition, or the like, which is essential to highlight.

---

## Symbols Found on the Unit

The following table describes symbols that may be found on the unit.















Definition of Symbols Found on the Unit			
			
On (Supply) IEC 417, No.5007	Off (Supply) IEC 417, No.5008	Earth (ground) IEC 417, No.5017	Protective earth (ground) IEC 417, No.5019
			
Frame or chassis IEC 417, No.5020	Equipotentiality IEC 417, No.5021	Direct current IEC 417, No.5031	Alternating current IEC 417, No.5032
			
Both direct and alternating current IEC 417, No.5033-a	Class II equipment IEC 417, No.5172-a	Three phase alternating current IEC 617-2 No.020206	
			
Caution, refer to accompanying documents ISO 3864, No.B.3.1	Caution, risk of electric shock ISO 3864, No.B.3.6	Caution, hot surface IEC 417, No.5041	

Table 1: Definition of Symbols Found on the Unit

## **Safety Procedures and Precautions**

**The following general safety precautions must be observed during all phases of operation of this instrument. Failure to comply with these precautions or with specific warnings elsewhere in this manual violates safety standards of intended use of the instrument and may impair the protection provided by the equipment. MKS Instruments, Inc. assumes no liability for the customer's failure to comply with these requirements.**

### **DO NOT SUBSTITUTE PARTS OR MODIFY INSTRUMENT**

Do not install substitute parts or perform any unauthorized modification to the instrument. Return the instrument to an MKS Calibration and Service Center for service and repair to ensure that all safety features are maintained.

### **SERVICE BY QUALIFIED PERSONNEL ONLY**

Operating personnel must not remove instrument covers. Component replacement and internal adjustments must be made by qualified service personnel only.

### **GROUNDING THE PRODUCT**

This product is grounded through the grounding conductor of the power cord. To avoid electrical shock, plug the power cord into a properly wired receptacle before connecting it to the product input or output terminals. A protective ground connection by way of the grounding conductor in the power cord is essential for safe operation.

### **DANGER ARISING FROM LOSS OF GROUND**

Upon loss of the protective-ground connection, all accessible conductive parts (including knobs and controls that may appear to be insulating) can render an electrical shock.

### **GROUND AND USE PROPER ELECTRICAL FITTINGS**

Dangerous voltages are contained within this instrument. All electrical fittings and cables must be of the type specified, and in good condition. All electrical fittings must be properly connected and grounded.

### **USE THE PROPER POWER CORD**

Use only a power cord that is in good condition and which meets the input power requirements specified in the manual.

Use only a detachable cord set with conductors that have a cross-sectional area equal to or greater than 0.75 mm<sup>2</sup>. The power cable should be approved by a qualified agency such as VDE, Semko, or SEV.

**USE THE PROPER POWER SOURCE**

This product is intended to operate from a power source that does not apply more voltage between the supply conductors, or between either of the supply conductors and ground, than that specified in the manual.

**USE THE PROPER FUSE**

Use only a fuse of the correct type, voltage rating, and current rating, as specified for your product.

**DO NOT OPERATE IN EXPLOSIVE ATMOSPHERES**

To avoid explosion, do not operate this product in an explosive environment unless it has been specifically certified for such operation.

**HIGH VOLTAGE DANGER**

High voltage is present in the cable, and in the sensor when the controller is turned on.

## Sicherheitshinweise

### In dieser Betriebsanleitung vorkommende Symbole

Definition der mit WARNUNG!, VORSICHT! und HINWEIS überschriebenen Abschnitte in dieser Betriebsanleitung.

#### Warnung!



---

Das Symbol **WARNUNG!** weist auf eine Gefahrenquelle hin. Es macht auf einen Arbeitsablauf, eine Arbeitsweise, einen Zustand oder eine sonstige Gegebenheit aufmerksam, deren unsachgemäße Ausführung bzw. ungenügende Berücksichtigung zu Körperverletzung führen kann.

---

#### Vorsicht!



---

Das Symbol **VORSICHT!** weist auf eine Gefahrenquelle hin. Es macht auf einen Bedienungsablauf, eine Arbeitsweise oder eine sonstige Gegebenheit aufmerksam, deren unsachgemäße Ausführung bzw. ungenügende Berücksichtigung zu einer Beschädigung oder Zerstörung des Produkts oder von Teilen des Produkts führen kann.

---

#### Hinweis



---

Das Symbol **HINWEIS** weist auf eine wichtige Mitteilung hin, die auf einen Arbeitsablauf, eine Arbeitsweise, einen Zustand oder eine sonstige Gegebenheit von besonderer Wichtigkeit aufmerksam macht.

---



## Am Gerät angebrachte Symbole

Der untenstehenden Tabelle sind die Bedeutungen der Symbole zu entnehmen, die an dem Gerät angebracht sind.















Definitionen der am Gerät angebrachten Symbole			
			
Ein (Netz) IEC 417, Nr. 5007	Aus (Netz) IEC 417, Nr. 5008	Erde IEC 417, Nr. 5017	Schutzleiter IEC 417, Nr. 5019
			
Rahmen oder Chassis IEC 417, Nr. 5020	Äquipotentialanschluß IEC 417, Nr. 5021	Gleichstrom IEC 417, Nr. 5031	Wechselstrom IEC 417, Nr. 5032
			
Wechselstrom und Gleichstrom IEC 417, Nr. 5033-a	Geräteklasse II IEC 417, Nr. 5172-a	Drehstrom IEC 617-2 Nr. 020206	
			
Vorsicht! Bitte Begleitdokumente lesen! ISO 3864, Nr. B.3.1	Vorsicht! Stromschlaggefahr! ISO 3864, Nr. B.3.6	Vorsicht! Heiße Fläche! IEC 417, Nr. 5041	

Tabelle 2: Definitionen der am Gerät angebrachten Symbole

## **Sicherheitsvorschriften und Vorsichtsmaßnahmen**

**Die untenstehenden allgemeinen Sicherheitsvorschriften sind bei allen Betriebsphasen dieses Instruments zu befolgen. Jede Mißachtung dieser Sicherheitsvorschriften oder sonstiger spezifischer Warnhinweise in dieser Betriebsanleitung stellt eine Zuwiderhandlung der für dieses Instrument geltenden Sicherheitsstandards dar und kann die an diesem Instrument vorgesehenen Schutzvorrichtungen unwirksam machen. MKS Instruments, Inc. haftet nicht für eine Mißachtung dieser Sicherheitsvorschriften seitens des Kunden.**

### **Keine Teile austauschen und keine Veränderungen vornehmen!**

Bauen Sie in das Instrument keine Ersatzteile ein, und nehmen Sie keine eigenmächtigen Änderungen am Gerät vor! Schicken Sie das Instrument zu Wartungs- und Reparaturzwecken an einen MKS-Kalibrierungs- und -Kundendienst ein! Dadurch wird sichergestellt, daß alle Sicherheitseinrichtungen voll funktionsfähig bleiben.

### **Wartung nur durch qualifizierte Fachleute!**

Das Gehäuse des Instruments darf vom Bedienpersonal nicht geöffnet werden. Das Auswechseln von Bauteilen und das Vornehmen von internen Einstellungen ist nur von qualifizierten Fachleuten durchzuführen.

### **Produkt erden!**

Dieses Produkt ist mit einer Erdleitung und einem Schutzkontakt am Netzstecker versehen. Um der Gefahr eines elektrischen Schlages vorzubeugen, ist das Netzkabel an einer vorschriftsmäßig geerdeten Schutzkontaktsteckdose anzuschließen, bevor es an den Eingangs- bzw. Ausgangsklemmen des Produkts angeschlossen wird. Das Instrument kann nur sicher betrieben werden, wenn es über den Erdleiter des Netzkabels und einen Schutzkontakt geerdet wird.

### **Gefährdung durch Verlust der Schutzerdung!**

Geht die Verbindung zum Schutzleiter verloren, besteht an sämtlichen zugänglichen Teilen aus stromleitendem Material die Gefahr eines elektrischen Schlages. Dies gilt auch für Knöpfe und andere Bedienelemente, die dem Anschein nach isoliert sind.

**Erdung und Verwendung geeigneter elektrischer Armaturen!**

In diesem Instrument liegen gefährliche Spannungen an. Alle verwendeten elektrischen Armaturen und Kabel müssen dem angegebenen Typ entsprechen und sich in einwand-freiem Zustand befinden. Alle elektrischen Armaturen sind vorschriftsmäßig anzubringen und zu erden.

**Richtiges Netzkabel verwenden!**

Das verwendete Netzkabel muß sich in einwandfreiem Zustand befinden und den in der Betriebsanleitung enthaltenen Anschlußwerten entsprechen.

Das Netzkabel muß abnehmbar sein. Der Querschnitt der einzelnen Leiter darf nicht weniger als 0,75 mm<sup>2</sup> betragen. Das Netzkabel sollte einen Prüfvermerk einer zuständigen Prüfstelle tragen, z.B. VDE, Semko oder SEV.

**Richtige Stromquelle verwenden!**

Dieses Produkt ist für eine Stromquelle vorgesehen, bei der die zwischen den Leitern bzw. zwischen jedem der Leiter und dem Masseleiter anliegende Spannung den in dieser Betriebsanleitung angegebenen Wert nicht überschreitet.

**Richtige Sicherung benutzen!**

Es ist eine Sicherung zu verwenden, deren Typ, Nennspannung und Nennstromstärke den Angaben für dieses Produkt entsprechen.

**Gerät nicht in explosiver Atmosphäre benutzen!**

Um der Gefahr einer Explosion vorzubeugen, darf dieses Gerät nicht in der Nähe explosiver Stoffe eingesetzt werden, sofern es nicht ausdrücklich für diesen Zweck zertifiziert worden ist.

**Hochspannungsgefahr!**

Bei eingeschaltetem Steuerteil liegt im Kabel und im Sensor Hochspannung an.

## Informations relatives à la sécurité

### Symboles utilisés dans ce manuel d'utilisation

Définition des indications AVERTISSEMENT, ATTENTION et REMARQUE utilisées dans ce manuel.

Avertissement



---

L'indication **AVERTISSEMENT** signale un danger potentiel. Elle est destinée à attirer l'attention sur une procédure, une utilisation, une situation ou toute autre chose présentant un risque de blessure en cas d'exécution incorrecte ou de non-respect des consignes.

---

Attention



---

L'indication **ATTENTION** signale un danger potentiel. Elle est destinée à attirer l'attention sur une procédure, une utilisation, une situation ou toute autre chose présentant un risque d'endommagement ou de dégât d'une partie ou de la totalité de l'appareil en cas d'exécution incorrecte ou de non-respect des consignes.

---

Remarque



---

L'indication **REMARQUE** signale des informations importantes. Elle est destinée à attirer l'attention sur une procédure, une utilisation, une situation ou toute autre chose présentant un intérêt particulier.

---

## Symboles apparaissant sur l'appareil

Le tableau suivant décrit les symboles apparaissant sur l'appareil.















Définition des symboles apparaissant sur l'appareil			
			
Marche (sous tension) IEC 417, No. 5007	Arrêt (hors tension) IEC 417, No. 5008	Terre (masse) IEC 417, No. 5017	Terre de protection (masse) IEC 417, No. 5019
			
Masse IEC 417, No. 5020	Equipotentialité IEC 417, No. 5021	Courant continu IEC 417, No. 5031	Courant alternatif IEC 417, No. 5032
			
Courant continu et alternatif IEC 417, No. 5033-a	Matériel de classe II IEC 417, No. 5172-a	Courant alternatif triphase IEC 617-2 No. 020206	
			
Attention : se reporter à la documentation ISO 3864, No. B.3.1	Attention : risque de secousse électrique ISO 3864, No. B.3.6	Attention : surface brûlante IEC 417, No. 5041	

Tableau 3: Définition des symboles apparaissant sur l'appareil

## **Mesures de sécurité et mises en garde**

**Prendre toutes les précautions générales suivantes pendant toutes les phases d'utilisation de cet appareil. Le non-respect de ces précautions ou des avertissements contenus dans ce manuel entraîne une violation des normes de sécurité relatives à l'utilisation de l'appareil et le risque de réduire le niveau de protection fourni par l'appareil. MKS Instruments, Inc. ne prend aucune responsabilité pour les conséquences de tout non-respect des consignes de la part de ses clients.**

### **NE PAS SUBSTITUER DES PIÈCES OU MODIFIER L'APPAREIL**

Ne pas utiliser de pièces détachées autres que celles vendues par MKS Instruments, Inc. ou modifier l'appareil sans l'autorisation préalable de MKS Instruments, Inc. Renvoyer l'appareil à un centre d'étalonnage et de dépannage MKS pour tout dépannage ou réparation afin de s'assurer que tous les dispositifs de sécurité sont maintenus.

### **DÉPANNAGE EFFECTUÉ UNIQUEMENT PAR UN PERSONNEL QUALIFIÉ**

L'opérateur de l'appareil ne doit pas enlever le capot de l'appareil. Le remplacement des composants et les réglages internes doivent être effectués uniquement par un personnel d'entretien qualifié.

### **MISE À LA TERRE DE L'APPAREIL**

Cet appareil est mis à la terre à l'aide du fil de terre du cordon d'alimentation. Pour éviter tout risque de secousse électrique, brancher le cordon d'alimentation sur une prise de courant correctement câblée avant de le brancher sur les bornes d'entrée ou de sortie de l'appareil. Une mise à la terre de protection à l'aide du fil de terre du cordon d'alimentation est indispensable pour une utilisation sans danger de l'appareil.

### **DANGER LIÉ À UN DÉFAUT DE TERRE**

En cas de défaut de terre, toutes les pièces conductrices accessibles (y compris les boutons de commande ou de réglage qui semblent être isolés) peuvent être source d'une secousse électrique.

### **MISE À LA TERRE ET UTILISATION CORRECTE D'ACCESSOIRES ÉLECTRIQUES**

Des tensions dangereuses existent à l'intérieur de l'appareil. Tous les accessoires et les câbles électriques doivent être conformes au type spécifié et être en bon état. Tous les accessoires électriques doivent être correctement connectés et mis à la terre.

### **UTILISATION D'UN CORDON D'ALIMENTATION APPROPRIÉ**

Utiliser uniquement un cordon d'alimentation en bon état et conforme aux exigences de puissance d'entrée spécifiées dans le manuel.

Utiliser uniquement un cordon d'alimentation amovible avec des conducteurs dont la section est égale ou supérieure à  $0,75 \text{ mm}^2$ . Le cordon d'alimentation doit être approuvé par un organisme compétent tel que VDE, Semko ou SEV.

#### **UTILISATION D'UNE ALIMENTATION APPROPRIÉE**

Cet appareil est conçu pour fonctionner en s'alimentant sur une source de courant électrique n'appliquant pas une tension entre les conducteurs d'alimentation, ou entre les conducteurs d'alimentation et le conducteur de terre, supérieure à celle spécifiée dans le manuel.

#### **UTILISATION D'UN FUSIBLE APPROPRIÉ**

Utiliser uniquement un fusible conforme au type, à la tension nominale et au courant nominal spécifiés pour l'appareil.

#### **NE PAS UTILISER DANS UNE ATMOSPHÈRE EXPLOSIVE**

Pour éviter tout risque d'explosion, ne pas utiliser l'appareil dans une atmosphère explosive à moins qu'il n'ait été approuvé pour une telle utilisation.



#### **DANGER DE HAUTE TENSION**

Une haute tension est présente dans le câble et dans le capteur lorsque le contrôleur est sous tension.

## Información sobre seguridad

### Símbolos usados en el manual de instrucciones

Definiciones de los mensajes de ADVERTENCIA, PRECAUCIÓN Y OBSERVACIÓN usados en el manual.

Advertencia		El símbolo de ADVERTENCIA indica un riesgo. <b>Pone de relieve un procedimiento, práctica, condición, etc., que, de no realizarse u observarse correctamente, podría causar lesiones a los empleados.</b>
Precaución		El símbolo de PRECAUCIÓN indica un riesgo. <b>Pone de relieve un procedimiento, práctica, etc., de tipo operativo que, de no realizarse u observarse correctamente, podría causar desperfectos al instrumento, o llegar incluso a causar su destrucción total o parcial.</b>
Observación		El símbolo de OBSERVACIÓN indica información de importancia. <b>Pone de relieve un procedimiento, práctica, condición, etc., cuyo conocimiento resulta esencial.</b>



## Símbolos que aparecen en la unidad

En la tabla que figura a continuación se indican los símbolos que aparecen en la unidad.















Definición de los símbolos que aparecen en la unidad			
			
Encendido (alimentación eléctrica) IEC 417, N.º 5007	Apagado (alimentación eléctrica) IEC 417, N.º 5008	Puesta a tierra IEC 417, N.º 5017	Protección a tierra IEC 417, N.º 5019
			
Caja o chasis IEC 417, N.º 5020	Equipotencialidad IEC 417, N.º 5021	Corriente continua IEC 417, N.º 5031	Corriente alterna IEC 417, N.º 5032
			
Corriente continua y alterna IEC 417, N.º 5033-a	Equipo de clase II IEC 417, N.º 5172-a	Corriente alterna trifásica IEC 617-2 N.º 020206	
			
Precaución. Consultar los documentos adjuntos ISO 3864, N.º B.3.1	Precaución. Riesgo de descarga eléctrica ISO 3864, N.º B.3.6	Precaución. Superficie caliente IEC 417, N.º 5041	

Tabla 4: Definición de los símbolos que aparecen en la unidad

## **Procedimientos y precauciones de seguridad**

**Las precauciones generales de seguridad que figuran a continuación deben observarse durante todas las fases de funcionamiento del presente instrumento. La no observancia de dichas precauciones, o de las advertencias específicas a las que se hace referencia en el manual, contraviene las normas de seguridad referentes al uso previsto del instrumento y podría impedir la protección que proporciona el instrumento. MKS Instruments, Inc., no asume responsabilidad alguna en caso de que el cliente haga caso omiso de estos requerimientos.**

### **NO UTILIZAR PIEZAS NO ORIGINALES NI MODIFICAR EL INSTRUMENTO**

No se debe instalar piezas que no sean originales ni modificar el instrumento sin autorización. Para garantizar que las prestaciones de seguridad se observen en todo momento, enviar el instrumento al Centro de servicio y calibración de MKS cuando sea necesaria su reparación y servicio de mantenimiento.

### **REPARACIONES EFECTUADAS ÚNICAMENTE POR TÉCNICOS ESPECIALIZADOS**

Los operarios no deben retirar las cubiertas del instrumento. El cambio de piezas y los reajustes internos deben efectuarlos únicamente técnicos especializados.

### **PUESTA A TIERRA DEL INSTRUMENTO**

Este instrumento está puesto a tierra por medio del conductor de tierra del cable eléctrico. Para evitar descargas eléctricas, enchufar el cable eléctrico en una toma debidamente instalada, antes de conectarlo a las terminales de entrada o salida del instrumento. Para garantizar el uso sin riesgos del instrumento resulta esencial que se encuentre puesto a tierra por medio del conductor de tierra del cable eléctrico.

### **PELIGRO POR PÉRDIDA DE LA PUESTA A TIERRA**

Si se pierde la conexión protectora de puesta a tierra, todas las piezas conductoras a las que se tiene acceso (incluidos los botones y mandos que pudieran parecer estar aislados) podrían producir descargas eléctricas.

### **PUESTA A TIERRA Y USO DE ACCESORIOS ELÉCTRICOS ADECUADOS**

Este instrumento funciona con voltajes peligrosos. Todos los accesorios y cables eléctricos deben ser del tipo especificado y mantenerse en buenas condiciones. Todos los accesorios eléctricos deben estar conectados y puestos a tierra del modo adecuado.

### **USAR EL CABLE ELÉCTRICO ADECUADO**

Usar únicamente un cable eléctrico que se encuentre en buenas condiciones y que cumpla los requisitos de alimentación de entrada indicados en el manual.

Usar únicamente un cable desmontable instalado con conductores que tengan un área de sección transversal equivalente o superior a 0,75mm<sup>2</sup>. El cable eléctrico debe estar aprobado por una entidad autorizada como, por ejemplo, VDE, Semko o SEV.

### **USAR LA FUENTE DE ALIMENTACIÓN ELÉCTRICA ADECUADA**

Este instrumento debe funcionar a partir de una fuente de alimentación eléctrica que no aplique más voltaje entre los conductores de suministro, o entre uno de los conductores de suministro y la puesta a tierra, que el que se especifica en el manual.

### **USAR EL FUSIBLE ADECUADO**

Usar únicamente un fusible del tipo, clase de voltaje y de corriente adecuados, según lo que se especifica para el instrumento.

### **EVITAR SU USO EN ENTORNOS EXPLOSIVOS**

Para evitar el riesgo de explosión, no usar este instrumento o en un entorno explosivo, a no ser que haya sido certificado para tal uso.

### **PELIGRO POR ALTO VOLTAJE**

Cuando el controlador está encendido, se registra alto voltaje en el cable y en el sensor.

# Chapter One: General Information

## Introduction

The MKS Type 270D High Accuracy Signal Conditioner is designed for the MKS 300 and 600 Series Baratron® high accuracy pressure sensors. Three versions are available with different display capabilities: a 4½ digit, 5½ digit, and a displayless unit. All versions are designed to fit in a standard ½ rack mount.

The 270 instrument consists of power supplies, an oscillator, and the heater supply necessary to interface with the compatible MKS 300 Series or 600 Series pressure sensors. The pressure can be read in mmHg, mbar, kPa, inHg, inH<sub>2</sub>O, cmH<sub>2</sub>O, and psi.

The 270 instrument can be combined with the Type 274 multiplexer unit to provide signal conditioning for up to three pressure sensors (from either the 300 or 600 Series, or a combination of both). The 270 controller interfaces with a pressure sensor through its HEAD and MULTIPLEX connectors.

## **How This Manual is Organized**

This manual is designed to provide instructions on how to set up and install a Type 270 unit.

**Before installing your Type 270 unit in a system and/or operating it, carefully read and familiarize yourself with all precautionary notes in the *Safety Messages and Procedures* section at the front of this manual. In addition, observe and obey all WARNING and CAUTION notes provided throughout the manual.**

Chapter One, *General Information*, (this chapter) introduces the product and describes the organization of the manual.

Chapter Two, *Installation*, explains the environmental requirements and describes how to mount the instrument in your system.

Chapter Three, *Overview*, gives a brief description of the instrument and its functionality.

Chapter Four, *Operation*, describes how to use the Type 270 instrument and explains all the functions and features.

Appendix A, *Product Specifications*, lists the specifications of the instrument.

### **Manual Conventions**

The following conventions apply throughout this manual:

XXXXXX *For inputs:* Indicates that the line must be pulled low to activate the function.

XXXXXX *For outputs:* Indicates that the output is active low.

### **Terminology**

The term *sensor* is used throughout the manual to describe a pressure measuring device that outputs the raw voltage reading to the 270 signal conditioner. The 270 unit converts the voltage reading into the pressure value. Strictly speaking, a *transducer* converts the voltage signal into a pressure reading and outputs the actual pressure value. A transducer does not require a signal conditioner.

## Customer Support

Standard maintenance and repair services are available at all of our regional MKS Calibration and Service Centers, listed on the back cover. In addition, MKS accepts the instruments of other manufacturers for recalibration using the Primary and Transfer Standard calibration equipment located at all of our regional service centers. Should any difficulties arise in the use of your Type 270 instrument, or to obtain information about companion products MKS offers, contact any authorized MKS Calibration and Service Center. If it is necessary to return the instrument to MKS, please obtain an ERA Number (Equipment Return Authorization Number) from the MKS Calibration and Service Center before shipping. The ERA Number expedites handling and ensures proper servicing of your instrument.

Please refer to the inside of the back cover of this manual for a list of MKS Calibration and Service Centers.

---

**Warning**

**All returns to MKS Instruments must be free of harmful, corrosive, radioactive, or toxic materials.**

---

Your 270 instrument can be calibrated with or without the pressure sensor. If you are using your 270 instrument with a high accuracy pressure sensor, and the units require calibration, you may wish to return both units to MKS. Calibrating the units together ensures the best possible accuracy.

This page intentionally left blank.

## Chapter Two: Installation

### How to Unpack the Type 270 Instrument

MKS has carefully packed the Type 270 unit so that it will reach you in perfect operating order. Upon receiving the unit, however, you should check for defects, cracks, broken connectors, etc., to be certain that damage has not occurred during shipment.

#### Note



Do *not* discard any packing materials until you have completed your inspection and are sure the unit arrived safely.

If you find any damage, notify your carrier and MKS immediately. If it is necessary to return the unit to MKS, obtain an ERA Number (Equipment Return Authorization Number) from the MKS Service Center before shipping. Please refer to the inside of the back cover of this manual for a list of MKS Calibration and Service Centers.

#### Caution



**Only qualified individuals should perform the installation and any user adjustments. They must comply with all the necessary ESD and handling precautions while installing and adjusting the instrument. Proper handling is essential when working with all highly sensitive precision electronic instruments.**

### Parts Checklist

#### *Standard Equipment:*

- Type 270 instrument
 

Displayless	270-0
4½ digit display	270-4
5½ digit display	270-5
- Type 270 Instruction Manual (this book)
- Power Cable CB270-4-xx (where xx = length in feet)

#### *Optional Equipment:*

- Electrical Connector Accessories Kit:  
270D-K1 (includes a mate for the I/O connector)



- Connector Cables:

**Note**

---

Braided, shielded cables may be necessary in noisy environments. To order braided, shielded cables, add an “S” after the cable type designation. For example, to order a standard connection cable to interface the Type 270 instrument to a 200 Series controller, use part number CB250-7-6; for a braided, shielded cable use part number CB250S-7-6.

---

CB270-2-2 and CB-270-4-2:	Connect the 270 to a 274 multiplexer unit - <i>both cables are required</i>
CB250-7-6:	Connects the 270 to a 200 Series controller
CB112-12-6:	Connects the 270 to a 600 Series controller

- Sensor Head Cables (xx = length in feet):

CB270-1-xx:	Connects 270, 274, or 670 electronics to 615, 616, 617 sensor head
CB270-2-xx	Connects 270, 274, or 670 electronics to 590, 690, 698 sensor head

- RM-6 Rack Mount

## **Companion Products**

The 270 instrument works with the following 600 Series pressure sensors:

- 698 Differential Sensor (regulated at 45° C)
- 690 Absolute Sensor (regulated at 45° C)
- 617 Bakeable Fast Absolute Sensor
- 616 Bakeable Differential Sensor
- 615 Bakeable Absolute Sensor
- 590 Absolute Sensor (regulated at 70° C)

The 270 instrument supports the following pressure sensors from the 300 Series:

- 398 Differential Sensor
- 391 Differential Sensor
- 390 Absolute Sensor
- 370 Absolute or Differential Sensor
- 317 Bakeable Fast Absolute Sensor
- 315 Bakeable Absolute or Differential Sensor
- 310 Absolute or Differential Sensor

The range of the full scale pressure sensors can vary from 0.1 to 25K mmHg.

In addition, the 270 instrument can interface with the following units:

- 273 Temperature Controller
- 274 Three Channel Multiplexer Unit
- 275 Set Point Unit
- 232 RS-232C Interface Unit
- 288 IEEE-488 Interface Unit

## **Product Location and Requirements**

The 270 unit fits in a standard ½ rack mount. It can be mounted in a panel cutout or a 19” rack when supplied with the RM-6 Rack Mount option.

### **Caution**



---

**Mount the Type 270 instrument in a location with sufficient air circulation to stay within the specified temperature range. Insufficient air circulation could damage the instrument.**

---

### **General Requirements**

- Operating temperature: 15° to 40° C (59° to 104° F)
- Power: 100, 120, 220, or 240 VAC ±10%, @ 50 to 60 Hz, 40 Watt (21 Watts with heater off)

## Chapter Three: Overview

### Front Panel Controls

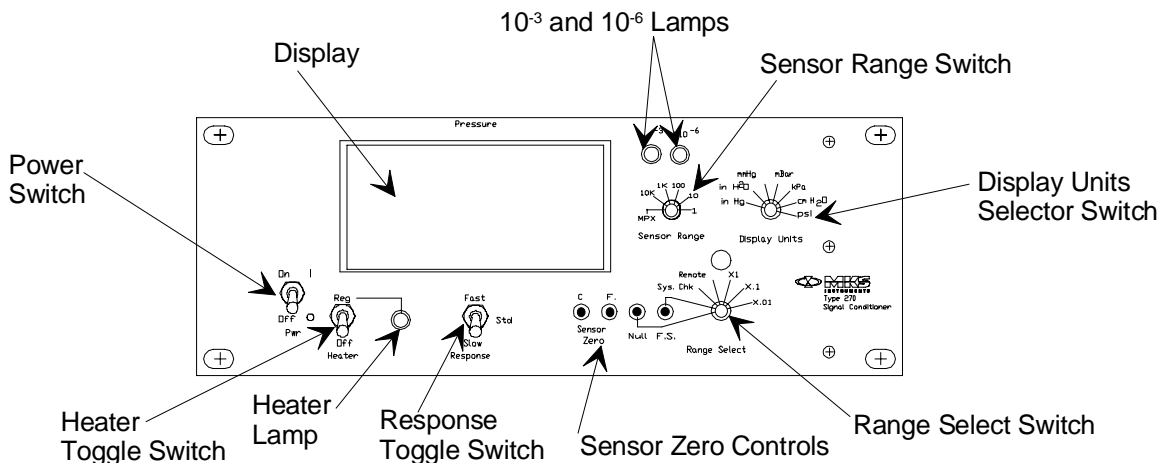

Figure 1: Front Panel of the 270-4 Unit

### Display

Both the 4½ digit instrument (270-4) and the 5½ digit (270-5) instrument contain an LED display to display the pressure readings.

### The x10<sup>-3</sup> and x10<sup>-6</sup> Lamps

*Neither lamp is included on the displayless unit (270-0). The 270-5 unit contains the x10<sup>-3</sup> lamp only. The 270-4 unit has both lamps.*

These lamps allow the 270 instrument to display readings between 0.10000 and 0.0010000 with the use of scientific notation. (The 270 instrument cannot display a decimal point to the left of the most significant digit on a full scale reading.) The 270 instrument displays a reading of 0.10000 as:

$$+100.00$$

with the x10<sup>-3</sup> lamp illuminated

### SENSOR RANGE Selector Switch

The **SENSOR RANGE** selector switch is not included on the displayless unit (270-0).

Set the **SENSOR RANGE** selector switch to match the range of the pressure sensor in use. The settings include 1, 10, 100, 1K 10K, and MPX (multiplex connector control). When using the 270 unit with a 274 multiplexer, place the **SENSOR RANGE** selector switch in the MPX position.

### Display Units Selector Switch

The **DISPLAY UNITS** selector switch is not included on the displayless unit (270-0).

The **DISPLAY UNITS** selector switch selects the units for the display. The pressure can be displayed in inHg, inH<sub>2</sub>O, mmHg, mbar, kPa, cmH<sub>2</sub>O, or psi.

### RANGE SELECT Switch

The **RANGE SELECT** switch controls the measurement mode of the instrument. The **REMOTE**, **x1**, **x0.1**, and **x0.01** positions are active measurement ranges while the **SYS CHK** (system check), **NULL** and **FULL SCALE** positions are functional check positions.

**NULL(B):** When the **RANGE SELECT** switch is placed in the **NULL** position, the input to the 270 instrument is placed at ground level. Use the **NULL** control to produce a zero reading on the front panel display or on an external readout using the DC output signal.

**F. S. (Full Scale) (C):** The F.S. control calibrates the gain of the 270 instrument to the internal Full Scale. When the **RANGE SELECT** switch is placed in the **FULL SCALE** position, the input to the 270 instrument is connected to an internal calibration signal. This control adjusts the gain of the signal conditioner. Use the **FULL SCALE** control to produce a full scale (+10 V) signal at the DC output or the 270 display.

**REMOTE:** When the **RANGE SELECT** switch is placed in the **REMOTE** position, the sensor range is selected by **HEAD RANGE IN TORR** switch on a 274 multiplexer.

**SYSCHK:** Position the **RANGE SELECT** switch in the **SYSCHK** position, to troubleshoot the 270 unit.

### SENSOR ZERO Controls

The **SENSOR ZERO C** control provides coarse zero adjustment. Use this control to set an approximate zero setting.

The **SENSOR ZERO F** control provides high resolution zero adjustment. Use this control to fine tune the zero setting. If you cannot adjust the zero setting sufficiently, position the fine control back to the midpoint and readjust the coarse control.

### RESPONSE Toggle Switch

This switch controls the electrical bandwidth of the instrument. The three positions are:

RESPONSE Switch Settings		
Setting	Hz	Milliseconds
FAST	165	1
NORMAL	4	40
SLOW	0.4	400

Table 5: RESPONSE Switch Settings

### HEATER Lamp

The HEATER lamp is illuminated when power is applied to the sensor heater.

### HEATER Toggle Switch

This switch controls power to the heaters. The switch has two positions: REG and OFF . When the switch is in the REG position, power is applied to the heaters in a sensor to maintain a preset temperature. This minimizes zero and span drift due to ambient temperature variation. This switch is a locking type switch and the handle must be *pulled back* to change positions. When the switch is in the OFF position, the heaters are not powered.

### POWER Switch

This switch controls power to the 270 instrument.

## Rear Panel Controls

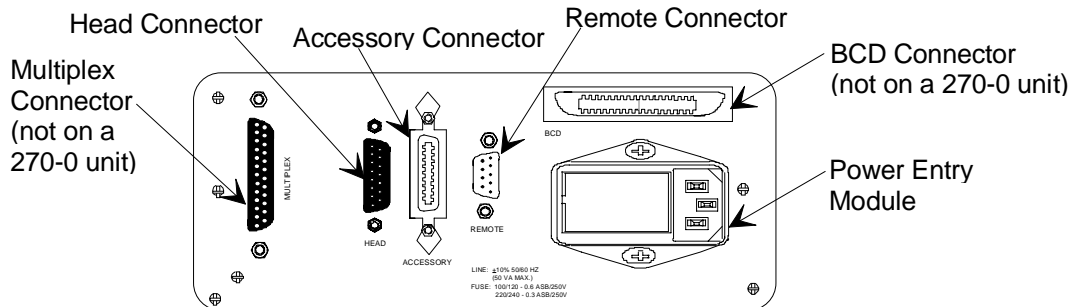

Figure 2: Rear Panel of the 270-4 Unit

### Note



The “No Connection” pin assignment refers to a pin with no internal connection.

### REMOTE Connector

This 9-pin male Type “D” connector allows an external device to access the range selection circuits. The three range selection inputs (1, 0.1, and 0.01), along with a 10.0 VDC output, are available through this connector. Table 6 lists the pin assignments.

REMOTE Connector (J402) Pinout	
Pin Number	Description
1	DC Output Voltage
2	No Connection
3	Select x0.1 Range
4	Select x0.01 Range
5	Digital Common
6	Chassis Ground
7	No Connection
8	DE Output Return
9	No Connection

Table 6: REMOTE Connector (J402) Pinout

### ACCESSORY Connector

This ribbon connector allows the 270 instrument to interface with accessory units. It provides a 0 to 10 VDC output and range ID. Table 7 lists the ACCESSORY connector pinout.

ACCESSORY Connector (J401) Pinout	
Pin Number	Description
1	DC Output Voltage
2	Remote Zero (Trigger)
3	Digital Common
4	x1 Range ID
5	x0.1 Range ID
6	x0.01 Range ID
7	+5 V
8	DC Output Return
9	No Connection
10	Good Data*
11	+13 V
12	Ground
13	-13 V
14	Chassis Ground
<i>* Used only by MKS</i>	

Table 7: ACCESSORY Connector (J401) Pinout



## HEAD Connector

This 15-pin female Type “D” connector connects the cable from the 270 instrument to a pressure sensor. Refer to Table 8 for the pin assignments.

HEAD Connector (J403) Pinout	
Pin Number	Description
1	Chassis Ground
2	Analog Common
3	Heater Return
4	Mux Input
5	No Connection
6	Signal Return
7	Signal Input
8	+ Heater
9	-13 V
10	+13 V
11	No Connection
12	No Connection
13	Preamp
14	System Check
15	Oscillator

Table 8: HEAD Connector (J403) Pinout

## Power Entry Module

This module contains the:

- RFI power line filter
- IEC power line connector
- Line Voltage selector
- Power line fuses (2)

For information on the Line Voltage selector, refer to *How to Change the Line Voltage Selection*, page 40. The *Maintenance* section, page 46, discusses the types of fuses used, and how to replace them.

## BCD Connector

This connector provides BCD and decimal point outputs. The pin assignments for the 4½ digit display and the 5½ digit display differ. Table 9 lists the pinout for a 4½ digit 270-4 unit; Table 10, page 33, lists the pinout for a 5½ digit 270-5 unit.

### Note



The displayless unit (270-0) does not have a BCD connector.

BCD Connector Pinout for Type 270-4 (4½ digit display)			
Pin Number	Description	Pin Number	Description
1	No Connection	17	$\overline{\text{Enable Digit 1}}$
2	No Connection	18	+5 V @ 25 mA
3	Digital Ground	19	$\overline{\text{Hold}}$
4	Digital Ground	20	Good Data*
5	10000	21	Decimal $\overline{+4P}$
6	No Connection	22	Decimal $\overline{+3P}$
7	$\overline{\text{Enable Digit 2}}$	23	Decimal $\overline{+2P}$
8	1	24	Decimal $\overline{-4P}$
9	No Connection	25	$\overline{\text{Chan 3 ID}}$
10	100	26	$\overline{\text{Overrange}}$
11	200	27	Polarity (+)
12	40	28	Digital Ground
13	400	29	No Connection
14	20	30	Data Ready
15	1000	31	$\overline{\text{Enable Digit 5}}$
16	10	32	$\overline{\text{Enable Digit 4}}$
* Used only by MKS			

Table 9: BCD Connector Pinout for Type 270-4 (4½ digit display)  
(Continued on next page)

<b>BCD Connector Pinout for Type 270-4 (4½ digit display) (Continued)</b>			
<b>Pin Number</b>	<b>Description</b>	<b>Pin Number</b>	<b>Description</b>
33	8000	42	800
34	$\overline{\text{Enable Reminder}}$	43	$\overline{\text{Chan 1 ID}}$
35	80	44	Decimal $\overline{+1P}$
36	2	45	Decimal $\overline{0P}$
37	4000	46	Decimal $\overline{-3P}$
38	4	47	Decimal $\overline{-2P}$
39	2000	48	Decimal $\overline{-1P}$
40	8	49	+5 Volt Return
41	$\overline{\text{Enable Digit 3}}$	50	$\overline{\text{Chan 2 ID}}$
<i>* Used only by MKS</i>			

Table 9: BCD Connector Pinout for Type 270-4 (4½ digit display)

BCD Connector Pinout for Type 270-5 (5½ digit display)			
Pin Number	Description	Pin Number	Description
1	8000	22	Decimal $\overline{+3P}$
2	2000	23	Decimal $\overline{+2P}$
3	80000	24	Decimal $\overline{-4P}$
4	20000	25	$\overline{\text{Chan 3 ID}}$
5	Data Ready	26	4000
6	Overrange	27	1000
7	Digital Ground	28	40000
8	800	29	10000
9	200	30	Polarity (+)
10	80	31	100000
11	20	32	$\overline{\text{Enable BCD}}$
12	8	33	400
13	2	34	100
14	No Connection	35	35
15	No Connection	36	10
16	No Connection	37	4
17	No Connection	38	1
18	+5 V @ 25 mA	39	No Connection
19	$\overline{\text{Hold}}$	40	No Connection
20	Good Data*	41	No Connection
21	Decimal $\overline{+4P}$	42	No Connection
* Used only by MKS			

Table 10: BCD Connector Pinout for the Type 270-5  
(Continued on next page)

BCD Connector Pinout for Type 270-5 (5½ digit display) (Continued)			
Pin Number	Description	Pin Number	Description
43	Chan 1 ID	47	Decimal -2P
44	Decimal +1P	48	Decimal -1P
45	Decimal 0P	49	+5 Volt Return
46	Decimal -3P	50	Chan 2 ID
* Used only by MKS			

Table 10: BCD Connector Pinout for the Type 270-5 (5½ digit display)

## BCD Interface Signals

The 270 instrument can communicate over the REMOTE DISPLAY HOLD, Data Ready, and Enable lines on the BCD connector.

### REMOTE DISPLAY HOLD Line

This line enables remote display control of the 270 instrument. Left open, the display will update at a rate of 2.5 samples per second. Holding this line low prohibits any updates to the display. To command the display to update, generate a positive going pulse with a duration of 50 microseconds, minimum, to 2 milliseconds, maximum.

### Data Ready Line

This line goes high when the data is valid and ready to read.

### Enable Lines

The BCD information is controlled by the enable lines. The 4½ digit 270-4, has six enable lines while the 5½ digit 270-5, has only one. (The displayless unit does not have any enable lines.) When these lines are connected to ground, all of the BCD information is at the connector and is valid when the DATA READY line goes high. When these lines are left open, or connected to +5 V, all of the BCD outputs are open. This is done when several meters are connected in parallel to a common bus. Each meter is strobed for a reading by grounding these control lines, and then when the reading has been taken, the lines are forced high again and the outputs are open.

#### Note



The channel ID and decimal point information is *not* controlled by these enable lines. This data is active at all times.

## Overranging Output on the 5½ Digit Unit (270-5)

The display on the 270 instrument overranges at 130,000 counts. When the display reaches its maximum count, it simply remains locked at that reading. Be wary of readings greater than full scale on these ranges.

---

**Note**

The BCD OVERRANGE signal *will become active* at 130,000 counts.

---

## MULTIPLEX Connector

This 25-pin female Type “D” connector provides access to the logic circuits of the 270 instrument. This connector links the 270 instrument with a 274 multiplexer. When the SENSOR RANGE switch is in the MPX position, the multiplexer controls the placement of the sensor range and channel ID through this connector. Refer to Table 11 for the pinout of the MULTIPLEX connector.

### Note



The displayless unit (270-0) does not have a MULTIPLEX connector.

MULTIPLEX Connector (J405) Pinout			
Pin Number	Description	Pin Number	Description
1	No Connection	14	No Connection
2	10K	15	No Connection
3	1K	16	No Connection
4	100	17	No Connection
5	10	18	0.1
6	1	19	No Connection
7	No Connection	20	No Connection
8	<u>Chan 1 ID Input</u>	21	Remote Read
9	<u>Chan 2 ID Input</u>	22	Digital Ground
10	<u>Chan 3 ID Input</u>	23	Digital Ground
11	Multiplex Select	24	No Connection
12	No Connection	25	Chassis Ground
13	No Connection		

Table 11: MULTIPLEX Connector (J405) Pinout

## Chapter Four: Operation

### How to Configure the 270 Instrument

1. Connect a pressure sensor to the 270 instrument with the appropriate cable.
2. Connect the 270 instrument to any other instrumentation, if applicable.

The upper drawing in Figure 3 shows the correct cables to use to connect the 270 instrument to a single pressure sensor and an MKS controller. The lower drawing shows the Type 270 instrument connected to a Type 274 multiplexer unit.

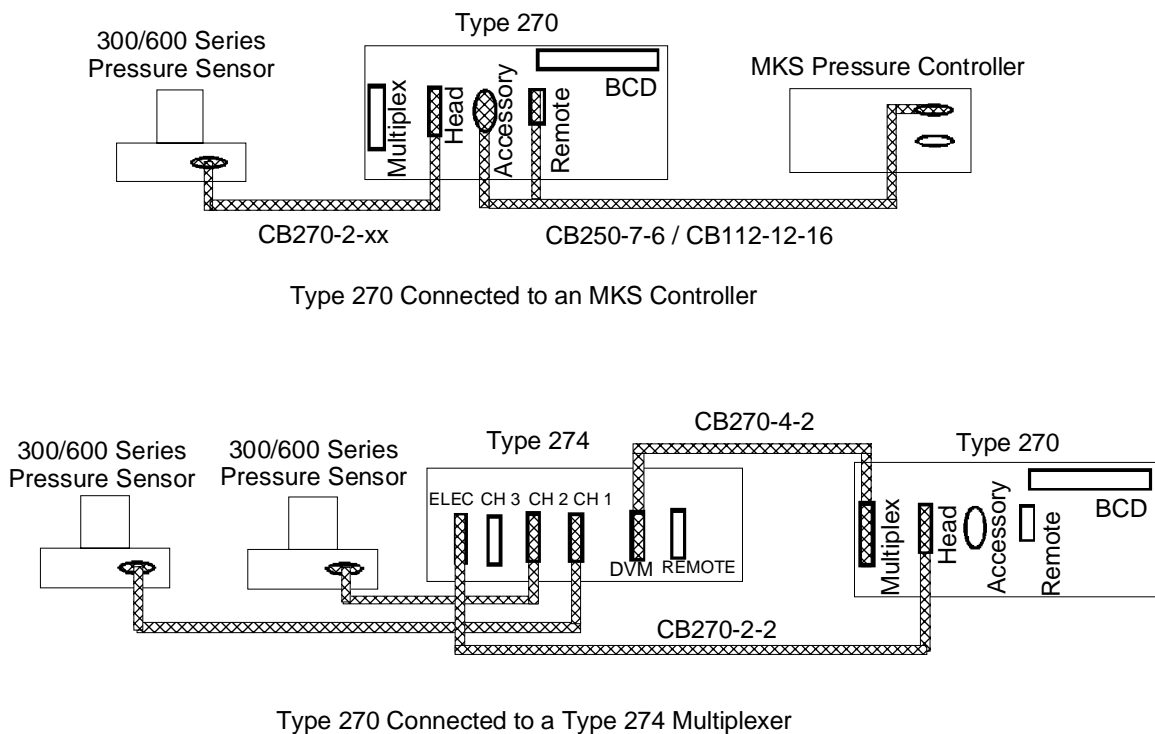

Figure 3: Interconnection Cables



3. Plug the power cable from the 270 instrument into a 115 VAC - 60 Hz power source.  
For a 230 VAC - 50 Hz power source, the power entry module must be set to the proper voltage. Refer to the *How to Change the Line Voltage Selection* section, beginning on page 40.
4. Apply power to the 270 instrument by placing the Power switch in the ON position.
5. *If you are using the 270 with a single pressure sensor*, place the SENSOR RANGE position the switch in the full scale value of the sensor in use.  
*If you are using the 270 with the 274 multiplexer unit*, position the SENSOR RANGE switch in the MPX position. Place the HEAD RANGE IN TORR switches, on the 274, to the full scale value of the sensor in use, for each channel.
6. Position the DISPLAY UNITS selector switch in the mmHg position.
7. *If you are using the 270 with a single pressure sensor*, place the HEATER switch to the REG position.  
*If you are using the 270 with the 274 multiplexer unit*, place the REG HEATER switches, on the 274, to the ON position. Place the REG switch on the 270 in the OFF position.  

This step applies power to the proportional heater circuit in the sensor. There will be a small delay between the closing of this switch and the lighting of the HEATER lamp. The lamp will turn on brightly and then, after the sensor warms up, the lamp will go to a lower intensity. Allow a minimum of four hours to stabilize a “cold” sensor. If possible, leave the heat on the sensor overnight. For optimal performance, leave the heater on constantly.
8. Place the RESPONSE switch in the STD position.  

The STD position offers the best all-around response versus noise performance for pressure measurement. Select the FAST position when you need a fast (1 millisecond) response. Select the SLOW position when reducing the amount of noise level on the DC output is more important than the system response time.
9. Position the RANGE SELECT switch in the NULL position.  
If necessary, adjust the NULL control to produce a zero reading on the front panel display or on an external display.
10. To calibrate the 270 instrument to its internal Full Scale standard, position the RANGE SELECT switch in the F.S. position.  
If necessary, adjust the F.S. control to produce a full scale reading of 10000 on the front panel display or an external display.
11. Pump the system to a pressure below the resolution of the pressure sensor.

12. Position the RANGE SELECT switch in the x0.01 position.

Refer to your sensor's Instruction Manual for the proper pressure to set the zero. If you are using a differential sensor, crossport the unit.

13. Check the zero reading and adjust if necessary.

*If you are using the 270 with a single pressure sensor, use the COARSE and FINE zero controls on the 270 to adjust the zero reading.*

*If you are using the 270 with a 274 multiplex unit, use the COARSE and FINE zero controls on the 274 multiplexer to adjust the zero reading. Repeat steps 11 through 13 for each channel in use.*

---

**Note**

When a 274 multiplexer is attached to the 270 instrument, the zero controls on the 274 unit override the controls on the 270 instrument. Use the zero controls on the multiplexer unit to adjust the zero.

---

14. Position the RANGE SELECT switch in the x1 position and adjust the NULL pot for a zero reading, if necessary.
15. Repeat steps 11 through 14 to produce a zero reading on all ranges.

---

**Note**

The frequency of setting the zero will depend on the application and its accuracy requirements, variations in ambient temperature, and the length of time since the instrument zero was last set. For extremely critical measurement of low pressures, check the zero more often and make minor adjustments, to ensure the most accurate readings.

---

16. Position the DISPLAY UNITS selector switch in the desired display units.
17. Place the RANGE SELECT switch in the x1 position.

The system is now ready to display the pressure range of the sensor. For  $1/10$  of that range, use the x0.1 position; for  $1/100$  use the x0.01 position.

## How to Change the Line Voltage Selection

The 270 instrument can use power from any of the following line voltages:

- 100 VAC
- 120 VAC (*factory default setting*)
- 220 VAC
- 240 VAC

To change the line voltage:

1. Disconnect the power cord from the 270 instrument.

### Warning



---

**To avoid an electrical shock, be sure to disconnect the power cord *before* proceeding.**

---

2. Disconnect all cables from the connectors located at the back of the unit.
3. Insert a small, flat head screw driver under the left hand side of the black plastic cover, and firmly pull towards you to unsnap the cover.

The cover will flip open, from left to right, to expose the line voltage selector drum and the two fuse holders. The two fuse holders are marked with up arrows (  ). Note that the cover is attached firmly, so it requires a strong force from the screw driver to loosen it.

4. Carefully grasp the line voltage selector drum and pull it out of its position.
5. Turn the selector drum to the appropriate line voltage and re-insert it into the 270 instrument so that the voltage value can be read from bottom to top.

The top and bottom of the voltage selector drum are shaped differently so that the drum will only fit into position in the correct orientation. The value of the selected line voltage will be visible through the window in the cover when it is closed.

## How to Select the Range Setting Remotely

1. Position the RANGE SELECT switch in the REMOTE position.
2. Apply the appropriate signal to select the desired range.

Table 12 lists the logic levels and the corresponding ranges.

<b>Remote Range Logic Levels</b>		
<b>Range</b>	<b>Remote Connector (J402)</b>	
	<b>Pin-3</b>	<b>Pin 4</b>
x1	HI	HI
x0.1	LO	HI
x0.01	HI	LO

Table 12: Remote Range Logic Levels

## Additional Procedures for the 0.1 Torr Sensors

The 0.1 Torr sensors require special instructions to adjust the zero setting on the sensor, and to use the remote zero setting on the 270 instrument.

### How to Adjust the Zero on the 0.1 Torr Full Scale Sensor

#### Note



1. **Do not** attempt to zero a 0.1 Torr Full Scale Type 690 or 698 pressure sensor with the Type 270 unit set to the x0.01 range. This configuration will introduce sufficient noise in the system to excessively distort the pressure signal and result in linearity and zero errors.
2. The x1 and x0.1 ranges operate within the specifications.

To zero a Type 690 or 698 0.1 Torr pressure sensor:

1. Power the sensor and turn on the heater.
2. Pump the unit down to a pressure less than  $5 \times 10^{-7}$  Torr.  
It will take at least 16 hours to establish a good, stable zero reading.
3. Center the COARSE and FINE zero controls.  
Turn both controls fully counterclockwise, then turn both controls 15 turns clockwise.
4. Adjust the COARSE zero control on the *sensor* until the display (or output) is nearly zero.

The sensor control is located in a hole in the lower loop in the letter “B” in the word “Baratron” on the top of the sensor. This control is a wirewound pot with approximately 100 turns. Rather than acting as a potentiometer, this control acts as a 100 position switch with about 200 to 1000 ppm F.S. per position (or wire). The stability of the setting is extremely good if the pot is centered on one wire. Time, temperature changes, or vibration may cause the pot to shift over time. Finding the center of a wire is complicated by the variable backlash between the zero control shaft and the wiper. To find the center of a wire:

- A. Verify that for each revolution of the sensor zero control shaft there are four distinct, stable steps in the 270 instrument display (or output).

Beware of unstable  $\frac{1}{2}$  steps. A stable step is one where the output doesn't change while the shaft is turned about  $\frac{1}{8}$  turn farther in the same direction.

- B. Turn the zero control shaft, in either direction, to the stable step nearest zero and record the reading.

It is usually not possible to set the reading to precisely zero because of the resolution of this control.

- C. Turn the shaft an extra  $\frac{1}{2}$  turn in the *same* direction.
- D. Turn the control back slowly until the same output just appears.
- E. Carefully turn the shaft an additional  $\frac{1}{8}$  turn in the same direction.

This will center the pot in the middle of a step for maximum stability.

**Note**

---

The above method is the *only* method that accurately finds the center of a wire. The technique of turning the zero control shaft clockwise until it shifts, turning it counterclockwise until it shifts, and positioning it midway does not work properly.

---

- 5. Adjust the COARSE and FINE zero controls on the 270 instrument to bring the display (or output) to precisely zero.

When using the Fine control, you may need to down range the 270 instrument to the x0.1 range to make the final setting. Do not use any other range settings.

**Using a Low Range Pressure Sensor with the Remote Zero Option**

If you are using a pressure sensor less than 1 Torr Full Scale and your 270 instrument is equipped with the Remote Zero option, you should consult an MKS Service Center. Your 270 instrument may need to be modified.

Please refer to the back cover of this manual for a list of the authorized MKS Calibration and Service Centers.

This page intentionally left blank.

## Chapter Five: Maintenance and Troubleshooting

### General

Should you encounter any difficulties while using your 270 instrument, contact any authorized MKS Calibration and Service Center. If it is necessary for you to return your instrument, please obtain an ERA (Equipment Return Authorization) Number before shipping. The ERA Number expedites handling and ensures proper service of your instrument.

Please refer to the back cover of this manual for a list of the authorized MKS Calibration and Service Centers.

#### **Warning**



---

**All returns to MKS Instruments must be free of harmful, corrosive, radioactive, or toxic materials.**

---



## How to Replace the Fuses

The only maintenance required on the Type 270 instrument is changing the fuses. To replace the fuses:

1. Select the proper fuses.

All units have two fuses installed to *fuse both sides* of the line. The fuse values, marked on the rear panel, are:

- 100/120 VAC = 0.6 Amperes Slow Blow Type
- 220/240 VAC = 0.3 Amperes Slow Blow Type

Refer to Table 13 for a description of the fuses. To change the line voltage selection, refer to the *How to Change the Line Voltage Selection* section on page 40.

Fuses for the Type 270 Instrument		
Nominal Line	Line Voltage Range	Fuse Type
100 VAC	90 - 110 VAC @50/60 Hz 75 VA (max)	0.63A (T), 250 V, 5x20 mm
120 VAC	108 - 132 VAC @50/60 Hz 75 VA (max)	0.63A (T), 250 V, 5x20 mm
220 VAC	198 - 242 VAC @50/60 Hz 75 VA (max)	0.315A (T), 250 V, 5x20 mm
240 VAC	216 - 264 VAC @50/60 Hz 75 VA (max)	0.315A (T), 250 V, 5x20 mm

Table 13: Fuses for the Type 270 Instrument

### Note



1. The fuses are IEC rated (where the name plate value is the expected current *carrying* rating) and not UL or CSA rated (where the name plate value is nearly the current *blowing* rating). Use of UL or CSA rated fuses will cause unnecessary blowing at high loads.
2. Appropriate replacement fuses include:
  - Bussmann GDC-T315 mA or equivalent for the 0.315 A fuse
  - Bussmann GDC-T630 mA or equivalent for the 0.63 A fuse

2. Disconnect the power cord from the 270 instrument.

**Warning**

---

**To avoid an electrical shock, be sure to disconnect the power cord *before* proceeding.**

---

3. Disconnect all cables from the connectors located at the back of the unit.
4. Insert a small, flat head screw driver under the left hand side of the black plastic cover, and firmly pull towards you to unsnap the cover.  

The cover will flip open, from left to right, to expose the line voltage selector drum and the two fuse carriers. The two fuse carriers are marked with up arrows (▲). Note that the cover is attached firmly, so it requires a strong force on the screw driver to loosen it.
5. Carefully slide the fuse carrier out and remove the fuse.
6. Insert the new fuse into the fuse carrier.  

Be certain that the new fuse is the appropriate type for the line voltage selection.
7. Slide the fuse carrier back into the Power Entry module.
8. Close the Power Entry module cover.
9. Connect any cables removed from the back of the 270 instrument in step 3 above.
10. Connect the power cord.

## **Troubleshooting**

This section describes the most common problems encountered with the 270 instrument and offers possible solutions.

**Hint:** If possible, substitute another similar instrument to verify that the problem involves the Type 270 instrument before proceeding.

### **Overrange (>11 Volts) or Erroneous Pressure Readings**

1. Verify that all vacuum fittings are tight and that the sensor is properly pumped down.  
Low range absolute sensors (100 mmHg and below) will be overranged at atmospheric pressure.
2. Connect another meter, either analog or digital, to the output to verify that the display of the 270 instrument is operating correctly.
3. Place the RANGE SELECT switch in the SYS CHK (System Check) position, the DISPLAY UNITS selector in the MMHG position, and perform the following checks:

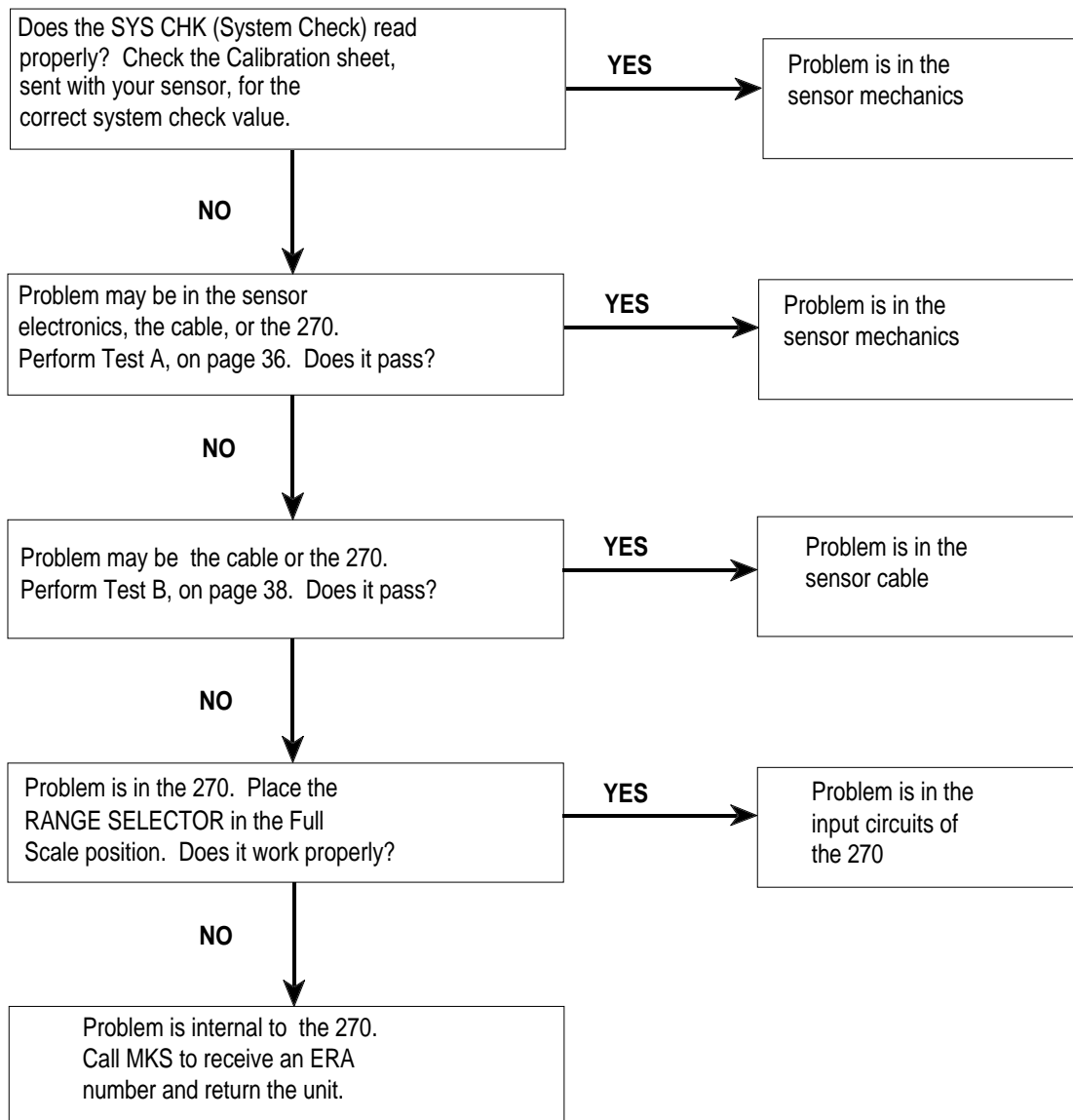

**Test A: Localizing the Malfunction to the Cable or the Electronics Unit**

Equipment Required:

Digital Volt Meter (DVM)

1. Disconnect the sensor cable from the sensor.
2. Place the RANGE SELECT switch in the SYS CHK position.
3. Place the REG switch in the OFF position.
4. Use the DVM to check the voltages at the sensor end of the cable.

Refer to Table 14 for the appropriate voltage values. Reference the DVM to pin H (2).

<b>Sensor Cable Voltage Check</b>		
<b>Sensor Cable Pin Number</b>	<b>Voltage</b>	<b>Function</b>
I or (13)	+12 to +13	Sensor electronics supply voltage
D or (14)	+12 to +13	System Check command
J or (15)	6 Volts RMS	Excitation voltage
<i>Note that some sensor cables use numbers while others use letters.</i>		

Table 14: Sensor Cable Voltage Check

5. Connect two resistors to the sensor cable, as shown in Figure 4.

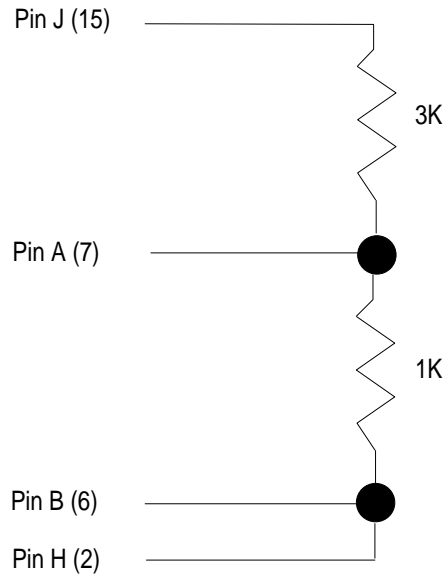

Figure 4: Sensor Cable Plus Two Resistors

This should produce a negative full scale reading,  $\pm 10\%$ , with the RANGE SELECT switch in the SYS CHK (System Check) position.

6. Connect a short circuit across the 1K resistor and place the RANGE SELECT in the x0.01 position. Adjust the COARSE zero control.

You should be able to adjust this control  $\pm 40\%$  of full scale. If you cannot adjust the COARSE zero control sufficiently, send the unit back to MKS for service. Refer to *Customer Support*, page 19, for instructions.

### Test B: Localizing Malfunctions to the Electronics Unit

1. Disconnect the sensor cable from the 270 instrument and check voltages at the sensor connector.
2. Place the RANGE SELECT switch in the SYS CHK position.
3. Place the REG switch in the OFF position.
4. Use the DVM to check the voltages at the sensor end of the cable.

Refer to Table 15 for the correct voltages.

Electronics Unit Voltage Check		
Connector Pin	Voltage	Function
13	+12 to +13	Sensor electronics supply voltage
14	+12 to +13	System Check command
15	6 Volts RMS	Excitation voltage

Table 15: Electronics Unit Voltage Check

5. Repeat step 5 of Test A at the sensor connection.

The results should be the same.

### How to Recalibrate the 270 Unit

Whenever components have been replaced in the 270 instrument, you must recalibrate the instrument.

1. Adjust the NULL control to set the zero reading.
2. Place the DISPLAY UNITS selector in the MMHG position.
3. Position the RANGE SELECT switch in the F.S. position and adjust for  $+10000 \pm 0.01\%$  (100000 for the 270-5).

## Appendix A: Product Specifications

*All specifications are at 23° C, 120 VAC*

Analog Output	0 to $\pm 10$ V on each range, into $>10K$ ohms load, available at rear connectors
Output Linearity	$\pm(0.005\%$ of reading $+0.001\%$ of full scale)
Accuracy (includes non-repeatability)	
x1 Range	100 ppm of reading
x0.1 Range	300 ppm of reading
x0.01 Range	500 ppm of reading
Output Impedance	$<1$ ohm
Output Noise	
0.01 - 0.4 Hz	$< 70$ $\mu$ Volts peak-to-peak on x1 and x0.1 ranges $< 350$ $\mu$ Volts peak-to-peak on x0.01 range
1 kHz - 1 MHz	$<4$ mVolt peak-to-peak
BCD Outputs ( <i>270-4 and 270-5 only</i> )	
Pressure Information	parallel line 3 state logic
Decimal points, channel ID range ID outputs	buffered TTL levels
Output Drive Ability	1 TTL load
Electromagnetic Compatibility <sup>1</sup>	EMC Directive 89/336/EEC
Dimensions	Standard MKS $\frac{1}{2}$ rack, $3\frac{1}{2}$ " H x $9\frac{1}{2}$ " W x 12" D (8.9 cm H x 24.1 cm W x 30.5 cm D)
Display	270-0      no display 270-4 $4\frac{1}{2}$ digit display ( $\frac{1}{2}$ " red segment LED) 270-5 $5\frac{1}{2}$ digit display ( $\frac{1}{2}$ " red segment LED)
Linearity	270-4 $\pm 0.01\%$ of reading $\pm 1$ count 270-5 $\pm 0.001\%$ of reading $\pm 1$ count
Update Rate	270-4      2.5 readings per second 270-5      1.4 readings per second

*(Table continued on next page)*

<sup>1</sup> Requires an overall metal braided shielded cable, properly grounded at both ends, during use.



Displayed Pressure Units	mmHg, mbar, kPa, inHg, inH <sub>2</sub> O, cmH <sub>2</sub> O, psi
Fuses	
90 - 132 VAC	0.6 Amperes Slow Blow Type
180 - 264 VAC	0.3 Amperes Slow Blow Type
Operating Temperature	15° to 40° C (59° to 104° F)
Power Requirement	100, 120, 220, or 240 VAC ±10%, @ 50 - 60 Hz, 40 Watt (21 Watts with heater off)
Ranges	x1, x0.1, and x0.01 of full range of the pressure sensor
Weight	8 lbs. ( 4 kg)
Zero Temperature Coefficient	<0.04 mV/° C

Due to continuing research and development activities, these product specifications are subject to change without notice.

## Index

### **O**

0.1 Torr sensors, using, 42–43

### **A**

Accessories, optional, 21

ACCESSORY connector, 29

### **B**

BCD, 31–34

### **C**

Communications, 34

    Data Ready line, 34

    Enable line, 34

    Remote Display Hold line, 34

Companion products, 23

Customer support, 19

### **D**

Data Ready line, 34

Digital readout, 25

DISPLAY UNITS switch, 26

### **E**

Enable line, 34

### **F**

Front panel, 25–27

Fuses, 46

### **H**

HEAD connector, 30

HEATER lamp, 27

HEATER switch, 27

### **I**

Introduction, 17

### **L**

Line voltage, changing, 40

Location requirements, 24

### **M**

Maintenance, 46

Manual

    conventions, 18

    organization, 18

    terminology, 18

MULTIPLEX connector, 36

### **P**

Power entry module, 30

POWER switch, 27

### **R**

RANGE SELECT switch, 26

Range setting, remotely, 41

Rear panel, 28–34

Recalibration, 52

REMOTE connector, 28

Remote Display Hold line, 34

RESPONSE switch, 27

Returns, 19, 45

## **S**

Scientific notation, lamps for, 25

SENSOR RANGE switch, 26

SENSOR ZERO controls, 26

Setup, 37–39

Specifications, 53–54

## **T**

Type 274 Multiplex unit, 17, 36, 37–39

## **Z**

Zero control, 26



## Artisan Technology Group is your source for quality new and certified-used/pre-owned equipment

- FAST SHIPPING AND DELIVERY
- TENS OF THOUSANDS OF IN-STOCK ITEMS
- EQUIPMENT DEMOS
- HUNDREDS OF MANUFACTURERS SUPPORTED
- LEASING/MONTHLY RENTALS
- ITAR CERTIFIED SECURE ASSET SOLUTIONS

### SERVICE CENTER REPAIRS

Experienced engineers and technicians on staff at our full-service, in-house repair center

### *InstraView*<sup>SM</sup> REMOTE INSPECTION

Remotely inspect equipment before purchasing with our interactive website at [www.instraview.com](http://www.instraview.com) ↗

### WE BUY USED EQUIPMENT

Sell your excess, underutilized, and idle used equipment. We also offer credit for buy-backs and trade-ins. [www.artisanng.com/WeBuyEquipment](http://www.artisanng.com/WeBuyEquipment) ↗

### LOOKING FOR MORE INFORMATION?

Visit us on the web at [www.artisanng.com](http://www.artisanng.com) ↗ for more information on price quotations, drivers, technical specifications, manuals, and documentation

**Contact us:** (888) 88-SOURCE | [sales@artisanng.com](mailto:sales@artisanng.com) | [www.artisanng.com](http://www.artisanng.com)