



Artisan Technology Group is your source for quality new and certified-used/pre-owned equipment

- FAST SHIPPING AND DELIVERY
- TENS OF THOUSANDS OF IN-STOCK ITEMS
- EQUIPMENT DEMOS
- HUNDREDS OF MANUFACTURERS SUPPORTED
- LEASING/MONTHLY RENTALS
- ITAR CERTIFIED SECURE ASSET SOLUTIONS

SERVICE CENTER REPAIRS

Experienced engineers and technicians on staff at our full-service, in-house repair center

*InstraView*SM REMOTE INSPECTION

Remotely inspect equipment before purchasing with our interactive website at www.instraview.com ↗

WE BUY USED EQUIPMENT

Sell your excess, underutilized, and idle used equipment. We also offer credit for buy-backs and trade-ins. www.artisanng.com/WeBuyEquipment ↗

LOOKING FOR MORE INFORMATION?

Visit us on the web at www.artisanng.com ↗ for more information on price quotations, drivers, technical specifications, manuals, and documentation

Contact us: (888) 88-SOURCE | sales@artisanng.com | www.artisanng.com

Last Revised: 2011-10-21 10:33:49.0

Low-Cost M Series Multifunction Data Acquisition - 16-Bit, 250 kS/s, up to 80 Analog Inputs

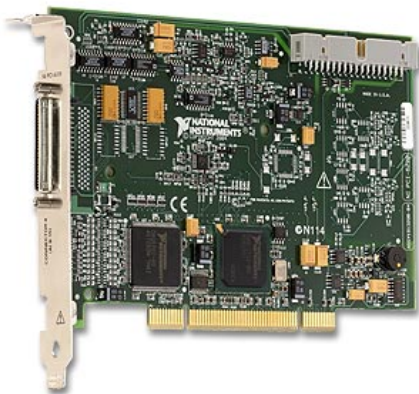

- NI recommends high-speed M Series (NI 625x) for 5X faster sampling rates, high-accuracy M Series (NI 628x) for 4X higher resolution, or industrial M Series (NI 623x) for 60 VDC isolation and superior noise rejection
- 16, 32, or 80 analog inputs at 16 bits, 250 kS/s
- Up to 4 analog outputs at 16 bits, 833 kS/s (6 μ s full-scale settling time)
- Programmable input range (± 10 , ± 5 , ± 1 , ± 0.2 V) per channel
- Up to 48 TTL/CMOS digital I/O lines (up to 32 hardware-timed at 1 MHz)
- Two 32-bit, 80 MHz counter/timers
- Digital triggering
- X1, X2, or X4 quadrature encoder inputs

Overview

NI M Series low-cost multifunction data acquisition (DAQ) devices provide optimized functionality for cost-sensitive applications. They have up to 80 analog inputs, 48 digital I/O lines, four analog outputs, two counter/timers, and digital triggering. Low-cost M Series devices have a one-year calibration interval. For better accuracy, faster speeds, and an extended two-year calibration service, consider high-speed and high-accuracy M Series devices.

[Back to Top](#)

Requirements and Compatibility

OS Information

Linux®
 Mac OS X
 Windows 2000/XP
 Windows 7
 Windows Vista x64/x86

Driver Information

NI-DAQmx
 NI-DAQmx Base

Software Compatibility

ANSI C
 LabVIEW
 LabVIEW SignalExpress
 LabWindows/CVI
 Measurement Studio
 Visual Basic
 Visual Studio .NET

[Back to Top](#)

Comparison Tables

| Family | Bus | Analog Inputs | Analog Input Resolution (bits) | Analog Outputs (AO) | AO Resolution (bits) | Max AO Rate (kS/S) | AO Range (V) | Digital I/O | Correlated (clocked) DIO |
|------------------|---------------|---------------|--------------------------------|---------------------|----------------------|--------------------|--------------|-------------|--------------------------|
| NI 6220 | PCI, PXI | 16 | 16 | - | - | - | - | 24 | 8, up to 1 MHz |
| NI 6221 | PCI, PXI, USB | 16 | 16 | 2 | 16 | 833 | ± 10 | 24 | 8, up to 1 MHz |
| NI 6221 (37-pin) | PCI | 16 | 16 | 2 | 16 | 833 | ± 10 | 10 | 2, up to 1 MHz |
| NI 6224 | PCI, PXI | 32 | 16 | - | - | - | - | 48 | 32, up to 1 MHz |

| Family | Bus | Analog Inputs | Analog Input Resolution (bits) | Analog Outputs (AO) | AO Resolution (bits) | Max AO Rate (kS/S) | AO Range (V) | Digital I/O | Correlated (clocked) DIO |
|---------|---------------|---------------|--------------------------------|---------------------|----------------------|--------------------|--------------|-------------|--------------------------|
| NI 6225 | PCI, PXI, USB | 80 | 16 | 2 | 16 | 833 | ±10 | 24 | 8, up to 1 MHz |
| NI 6229 | PCI, PXI, USB | 32 | 16 | 4 | 16 | 833 | ±10 | 48 | 32, up to 1 MHz |

[Back to Top](#)

Application and Technology

M Series for Test

For test, you can use 16-bit, 250 kS/s analog inputs and 1 MHz digital lines with NI signal conditioning for applications including data logging and sensor measurements. Low-cost M Series devices are compatible with the NI SCC and SCXI signal conditioning platforms, which provide amplification, filtering, and power for virtually every type of sensor. These platforms also are compliant with IEEE 1451.4 smart transducer electronic data sheet (TEDS) sensors, which provide digital storage for sensor data sheet information.

M Series for Control

Low-cost M Series digital lines can drive 24 mA for relay and actuator control. With up to four analog outputs, two 80 MHz counter/timers, and six DMA channels, M Series devices can execute multiple control loops simultaneously. Low-cost M Series devices also have direct support for encoder measurements, protected digital lines, and digital debounce filters for control applications. With up to 80 analog inputs, 32 clocked digital lines at rates of 1 MHz, and four analog outputs, you can execute multiple control loops with a single device. For higher-count control loops, you can use M Series devices in conjunction and tightly synchronized with National Instruments analog output devices for 64 or more loops.

M Series for Design

You can use the wide range of I/O – from 80 analog inputs to 48 digital lines – to measure and verify prototype designs. M Series devices and NI LabVIEW SignalExpress interactive measurement software deliver benchtop measurements to the PC. With LabVIEW SignalExpress interactive configuration-based steps, you can quickly create design verification tests. The fast acquisition and generation rates of low-cost M Series devices along with LabVIEW SignalExpress provide on-the-fly design analysis. You can convert your tested and verified LabVIEW SignalExpress projects to LabVIEW applications for immediate M Series DAQ use and bridge the gap between test, control, and design applications.

Hybrid-Slot-Compatible PXI Modules

PXI M Series modules are hybrid-slot-compatible so that you can use them in both PXI slots and the hybrid slots found in new PXI Express chassis. The PXI Systems Alliance specifies that hybrid-slot-compatible PXI modules use modified slot connectors to mechanically fit in both PXI slots and hybrid slots. This mechanical change:

- Provides compatibility with past, current, and future PXI chassis

- Maintains existing product specifications

- Requires no software changes (application or driver)

- Maintains speed and capability of all PXI communication (PXI Express signaling is not provided)

However, hybrid-slot-compatible PXI modules do not include the pins used to implement PXI local bus communication, which is used for backplane SCXI control from the right-most PXI slot in PXI/SCXI combination chassis (NI PXI-1010, PXI-1011, PXI-1050, and PXI-1052). For these applications, NI provides unmodified PXI M Series modules that maintain the required local bus capabilities. Refer to the SCXI Control of PXI/SCXI Combination Chassis section in the Ordering Information section for part numbers.

Simultaneous and Intelligent Data Acquisition

When you need to obtain performance from a data acquisition device beyond the capabilities of a multifunction data acquisition device, National Instruments provides simultaneous sampling with NI S Series and intelligent data acquisition with NI R Series. The S Series architecture dedicates an analog-to-digital converter (ADC) per channel to provide higher aggregate sampling rates compared to multiplexed devices. S Series devices are ideal for applications including IF digitization, transient recording, ultrasound and sonar testing, and high-energy physics. R Series multifunction DAQ devices contain a field-programmable gate array (FPGA) that is reconfigurable using the LabVIEW FPGA Module. R Series multifunction devices combine analog input, analog output, and digital I/O on a single device. You can customize these devices to develop capabilities such as complete control over the synchronization and timing of all signals and operations; user-defined onboard decision-making logic; and digital lines individually configurable as input, output, counter/timers, pulse-width modulation (PWM), flexible encoder inputs, or user-defined communication protocols.

Industrial M Series

When you need performance and accuracy from a data acquisition device in an electrically noisy or harsh environment, consider industrial NI M Series devices. They offer a set of high-reliability features, including isolation, ±20 mA current I/O, 24 V digital logic levels, and digital debounce filters. Isolation prevents ground loops, rejects high common-mode voltages, and protects users and equipment from high-voltage transients. Four to 20 mA current loops are immune to most sources of electrical noise and voltage (IR) drops along extensive cable lengths. Sourcing or sinking 24 V digital I/O interfaces directly with pumps, valves, relays, and other industry-standard sensors and actuators; programmable debounce filters remove glitches and spikes from switches and relays connected to digital input lines.

Recommended Accessories

Signal conditioning is required for sensor measurements or voltage inputs greater than 10 V. NI SCXI is a versatile, high-performance signal conditioning platform optimized for high-channel-count applications. NI SCC provides portable, flexible signal conditioning options on a per-channel basis. Visit ni.com/sigcon for NI signal conditioning resources. The NI PCI-6221 (37-Pin) offers a 37-pin D-Sub connector that lowers connectivity costs by 80 percent. The D-Sub connector makes the PCI-6221 (37-Pin) ideal for OEM applications; however, its connector is not compatible with SCC or SCXI signal conditioning.

Recommended Driver Software

National Instruments measurement services software, built around NI-DAQmx driver software, includes intuitive application programming interfaces, configuration tools, I/O assistants, and other tools designed to reduce system setup, configuration, and development time. National Instruments recommends using the latest version of NI-DAQmx driver software for application development in NI LabVIEW and LabWindows™/CVI, ANSI C/C++, C#, Visual Basic .NET, and Visual Basic 6.0. To download the most recent version of NI-DAQmx software, visit ni.com/support/daq/versions. Linux and Mac OS X users can program M Series devices with NI-DAQmx Base driver software. M Series devices are compatible with the following versions (or later) of NI application software – LabVIEW, LabWindows/CVI, or Measurement Studio versions 7.x; LabVIEW SignalExpress 1.x; VI Logger 2.0; or LabVIEW with the LabVIEW Real-Time Module 7.1. M Series devices are not compatible with the Traditional NI-DAQ (Legacy) driver.

NI measurement services software speeds up your development with features including the following:

- A guide to create fast and accurate measurements with no programming using the DAQ Assistant

- Automatic code generation to create your application in LabVIEW; LabWindows/CVI; LabVIEW SignalExpress; and C#, Visual Studio .NET, ANSI C/C++, or Visual Basic using Measurement Studio

- Multithreaded streaming technology for 1,000 times performance improvements

- Automatic timing, triggering, and synchronization routing to make advanced applications easy

- Thousands of free software downloads available at ni.com/zone to jump-start your project

Software configuration of all digital I/O features without hardware switches/jumpers

Single programming interface for analog input, analog output, digital I/O, and counters on hundreds of multifunction DAQ hardware devices

M Series devices are compatible with the following versions (or later) of NI application software – LabVIEW, LabWindows/CVI, or Measurement Studio versions 7.x; and LabVIEW SignalExpress 2.x.

[Back to Top](#)

Ordering Information

For a complete list of accessories, visit the product page on ni.com.

| Products | Part Number | Recommended Accessories | Part Number |
|---|-------------|---|-------------|
| NI PCI-6220 | | | |
| NI PCI-6220 Each NI PCI-6220 requires: 1 Cable, 1 Connector Block | 779065-01 | Cable: Shielded - SHC68-68-EPM Cable (2m) **Also available: <i>Unshielded</i> | 192061-02 |
| | | Connector Block: Screw Terminals - SCB-68 **Also available: <i>BNC Termination</i> | 776844-01 |
| NI PXI-6220 | | | |
| NI PXI-6220 Each NI PXI-6220 requires: 1 Cable, 1 Connector Block | 779112-01 | Cable: Shielded - SHC68-68-EPM Cable (2m) **Also available: <i>Unshielded</i> | 192061-02 |
| | | Connector Block: Screw Terminals - SCB-68 **Also available: <i>BNC Termination</i> | 776844-01 |
| NI PCI-6221 | | | |
| NI PCI-6221 Each NI PCI-6221 requires: 1 Cable, 1 Connector Block | 779066-01 | Cable: Shielded - SHC68-68-EPM Cable (2m) **Also available: <i>Unshielded</i> | 192061-02 |
| | | Connector Block: Screw Terminals - SCB-68 **Also available: <i>BNC Termination</i> | 776844-01 |
| NI PCI-6224 | | | |
| NI PCI-6224 Each NI PCI-6224 requires: 2 Cables, 2 Connector Blocks | 779067-01 | Connector 0: | |
| | | Cable: Shielded - SHC68-68-EPM Cable (2m) **Also available: <i>Unshielded</i> | 192061-02 |
| | | Connector Block: Screw Terminals - SCB-68 **Also available: <i>BNC Termination</i> | 776844-01 |
| | | Connector 1: | |
| | | Cable: Shielded - SHC68-68-EPM Cable (2m) **Also available: <i>Unshielded</i> | 192061-02 |
| | | Connector Block: Screw Terminals - SCB-68 **Also available: <i>BNC Termination</i> | 776844-01 |
| NI PXI-6224 | | | |
| NI PXI-6224 Each NI PXI-6224 requires: 2 Cables, 2 Connector Blocks | 779114-01 | Connector 0: | |
| | | Cable: Shielded - SHC68-68-EPM Cable (2m) **Also available: <i>Unshielded</i> | 192061-02 |
| | | Connector Block: Screw Terminals - SCB-68 **Also available: <i>BNC Termination</i> | 776844-01 |
| | | Connector 1: | |
| | | Cable: Shielded - SHC68-68-EPM Cable (2m) **Also available: <i>Unshielded</i> | 192061-02 |
| | | Connector Block: Screw Terminals - SCB-68 **Also available: <i>BNC Termination</i> | 776844-01 |
| NI PCI-6225 | | | |
| NI PCI-6225 Each NI PCI-6225 requires: 2 Cables, 2 Connector Blocks | 779295-01 | Connector 0: | |
| | | Cable: Shielded - SHC68-68-EPM Cable (2m) **Also available: <i>Unshielded</i> | 192061-02 |
| | | Connector Block: Screw Terminals - SCB-68 **Also available: <i>BNC Termination</i> | 776844-01 |
| | | Connector 1: | |
| | | Cable: Shielded - SHC68-68 Cable (2m) **Also available: <i>Unshielded</i> | 191945-02 |
| | | Connector Block: Screw Terminals - SCB-68 **Also available: <i>BNC Termination</i> | 776844-01 |
| NI PXI-6225 | | | |

| | | |
|---|-----------|--|
| NI PXI-6225 Each NI PXI-6225 requires: 2 Cables, 2 Connector Blocks | 779296-01 | Connector 0: Cable: Shielded - SHC68-68-EPM Cable (2m) 192061-02 <i>**Also available: Unshielded</i> Connector Block: Screw Terminals - SCB-68 776844-01 <i>**Also available: BNC Termination</i> Connector 1: Cable: Shielded - SHC68-68 Cable (2m) 191945-02 <i>**Also available: Unshielded</i> Connector Block: Screw Terminals - SCB-68 776844-01 <i>**Also available: BNC Termination</i> |
| NI PCI-6229 | | |
| NI PCI-6229 Each NI PCI-6229 requires: 2 Cables, 2 Connector Blocks | 779068-01 | Connector 0: Cable: Shielded - SHC68-68-EPM Cable (1m) 192061-01 <i>**Also available: Unshielded</i> Connector Block: Screw Terminals - SCB-68 776844-01 <i>**Also available: BNC Termination</i> Connector 1: Cable: Shielded - SHC68-68-EPM Cable (1m) 192061-01 <i>**Also available: Unshielded</i> Connector Block: Screw Terminals - SCB-68 776844-01 <i>**Also available: BNC Termination</i> |
| NI PXI-6229 | | |
| NI PXI-6229 Each NI PXI-6229 requires: 2 Cables, 2 Connector Blocks | 779630-01 | Connector 0: Cable: Shielded - SHC68-68-EPM Cable (2m) 192061-02 <i>**Also available: Unshielded</i> Connector Block: Screw Terminals - SCB-68 776844-01 <i>**Also available: BNC Termination</i> Connector 1: Cable: Shielded - SHC68-68-EPM Cable (2m) 192061-02 <i>**Also available: Unshielded</i> Connector Block: Screw Terminals - SCB-68 776844-01 <i>**Also available: BNC Termination</i> |
| NI PXI-6229 for SCXI Control in PXI/SCXI Combination Chassis Each NI PXI-6229 for SCXI Control in PXI/SCXI Combination Chassis requires: 2 Cables, 2 Connector Blocks | 779115-01 | Connector 0: Cable: Shielded - SHC68-68-EPM Cable (2m) 192061-02 <i>**Also available: Unshielded</i> Connector Block: Screw Terminals - SCB-68 776844-01 <i>**Also available: BNC Termination</i> Connector 1: Cable: Shielded - SHC68-68-EPM Cable (2m) 192061-02 <i>**Also available: Unshielded</i> Connector Block: Screw Terminals - SCB-68 776844-01 <i>**Also available: BNC Termination</i> |
| NI PXI-6221 | | |
| NI PXI-6221 Each NI PXI-6221 requires: 1 Cable, 1 Connector Block | 779629-01 | Cable: Shielded - SHC68-68-EPM Cable (2m) 192061-02 <i>**Also available: Unshielded</i> Connector Block: Screw Terminals - SCB-68 776844-01 <i>**Also available: BNC Termination</i> |
| NI PXI-6221 for SCXI Control in PXI/SCXI Combination Chassis Each NI PXI-6221 for SCXI Control in PXI/SCXI Combination Chassis requires: 1 Cable, 1 Connector Block | 779113-01 | Cable: Shielded - SHC68-68-EPM Cable (2m) 192061-02 <i>**Also available: Unshielded</i> Connector Block: Screw Terminals - SCB-68 776844-01 <i>**Also available: BNC Termination</i> |
| NI PCI-6221 37-pin | | |
| NI PCI-6221 37-pin Each NI PCI-6221 37-pin requires: 1 Cable, 1 Connector Block | 779418-01 | Cable: Shielded - SH37F-37M Cable (2m) 778621-02 Connector Block: Screw Terminals - CB-37FH 778673-01 |

[Back to Top](#)

Software Recommendations

LabVIEW Professional Development System for Windows

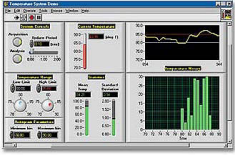

Advanced software tools for large project development
Automatic code generation using DAQ Assistant and Instrument I/O Assistant
Tight integration with a wide range of hardware
Advanced measurement analysis and digital signal processing
Open connectivity with DLLs, ActiveX, and .NET objects
Capability to build DLLs, executables, and MSI installers

NI LabVIEW SignalExpress for Windows



Quickly configure projects without programming
Control over 400 PC-based and stand-alone instruments
Log data from more than 250 data acquisition devices
Perform basic signal processing, analysis, and file I/O
Scale your application with automatic LabVIEW code generation
Create custom reports or easily export data to LabVIEW, DIAdem or Microsoft Excel

NI LabWindows™/CVI for Windows



Real-time advanced 2D graphs and charts
Complete hardware compatibility with IVI, VISA, DAQ, GPIB, and serial
Analysis tools for array manipulation, signal processing statistics, and curve fitting
Simplified cross-platform communication with network variables
Measurement Studio .NET tools (included in LabWindows/CompactRIO Full only)
The mark LabWindows is used under a license from Microsoft Corporation.

NI Measurement Studio Professional Edition

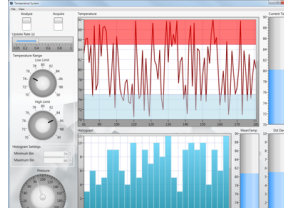

Customizable graphs and charts for WPF, Windows Forms, and ASP.NET Web Forms UI design
Analysis libraries for array operations, signal generation, windowing, filters, signal processing
Hardware integration support with native .NET data acquisition and instrument control libraries
Automatic code generation for all NI-DAQmx data acquisition hardware
Intelligent and efficient data-logging libraries for streaming measurement data to disk
Support for Microsoft Visual Studio .NET 2012/2010/2008

[Back to Top](#)

Support and Services

System Assurance Programs

NI system assurance programs are designed to make it even easier for you to own an NI system. These programs include configuration and deployment services for your NI PXI, CompactRIO, or Compact FieldPoint system. The NI Basic System Assurance Program provides a simple integration test and ensures that your system is delivered completely assembled in one box. When you configure your system with the NI Standard System Assurance Program, you can select from available NI system driver sets and application development environments to create customized, reorderable software configurations. Your system arrives fully assembled and tested in one box with your software preinstalled. When you order your system with the standard program, you also receive system-specific documentation including a bill of materials, an integration test report, a recommended maintenance plan, and frequently asked question documents. Finally, the standard program reduces the total cost of owning an NI system by providing three years of warranty coverage and calibration service. Use the online product advisors at ni.com/advisor to find a system assurance program to meet your needs.

Calibration

NI measurement hardware is calibrated to ensure measurement accuracy and verify that the device meets its published specifications. To ensure the ongoing accuracy of your measurement hardware, NI offers basic or detailed recalibration service that provides ongoing ISO 9001 audit compliance and confidence in your measurements. To learn more about NI calibration services or to locate a qualified service center near you, contact your local sales office or visit ni.com/calibration.

Technical Support

Get answers to your technical questions using the following National Instruments resources.

Support - Visit ni.com/support to access the NI KnowledgeBase, example programs, and tutorials or to contact our applications engineers who are located in NI sales offices around the world and speak the local language.

Discussion Forums - Visit forums.ni.com for a diverse set of discussion boards on topics you care about.

Online Community - Visit community.ni.com to find, contribute, or collaborate on customer-contributed technical content with users like you.

Repair

While you may never need your hardware repaired, NI understands that unexpected events may lead to necessary repairs. NI offers repair services performed by highly trained technicians who quickly return your device with the guarantee that it will perform to factory specifications. For more information, visit ni.com/repair.

Training and Certifications

The NI training and certification program delivers the fastest, most certain route to increased proficiency and productivity using NI software and hardware. Training builds the skills to more efficiently develop robust, maintainable applications, while certification validates your knowledge and ability.

Classroom training in cities worldwide - the most comprehensive hands-on training taught by engineers.

On-site training at your facility - an excellent option to train multiple employees at the same time.

Online instructor-led training - lower-cost, remote training if classroom or on-site courses are not possible.

Course kits - lowest-cost, self-paced training that you can use as reference guides.

Training memberships and training credits - to buy now and schedule training later.

Visit ni.com/training for more information.

Extended Warranty

NI offers options for extending the standard product warranty to meet the life-cycle requirements of your project. In addition, because NI understands that your requirements may change, the extended warranty is flexible in length and easily renewed. For more information, visit ni.com/warranty.

OEM

NI offers design-in consulting and product integration assistance if you need NI products for OEM applications. For information about special pricing and services for OEM customers, visit ni.com/oem.

Alliance

Our Professional Services Team is comprised of NI applications engineers, NI Consulting Services, and a worldwide National Instruments Alliance Partner program of more than 700 independent consultants and integrators. Services range from start-up assistance to turnkey system integration. Visit ni.com/alliance.

[Back to Top](#)

Detailed Specifications

Specifications listed below are typical at 25 °C unless otherwise noted. Refer to the *M Series User Manual* for more information about NI 622x devices.

Analog Input

Number of channels

| | |
|--------------|------------------------------------|
| NI 6220/6221 | 8 differential or 16 single ended |
| NI 6224/6229 | 16 differential or 32 single ended |
| NI 6225 | 40 differential or 80 single ended |

| | |
|----------------|---------|
| ADC resolution | 16 bits |
|----------------|---------|

| | |
|-----|-----------------------------|
| DNL | No missing codes guaranteed |
|-----|-----------------------------|

| | |
|-----|--|
| INL | Refer to the <i>AI Absolute Accuracy Table</i> |
|-----|--|

Sampling rate

| | |
|---------|--|
| Maximum | 250 kS/s single channel, 250 kS/s multi-channel (aggregate) |
|---------|--|

| | |
|---------|------------|
| Minimum | No minimum |
|---------|------------|

| | |
|-----------------|-----------------------|
| Timing accuracy | 50 ppm of sample rate |
|-----------------|-----------------------|

| | |
|-------------------|-------|
| Timing resolution | 50 ns |
|-------------------|-------|

| | |
|----------------|----|
| Input coupling | DC |
|----------------|----|

| | |
|-------------|---------------------------|
| Input range | ±10 V, ±5 V, ±1 V, ±0.2 V |
|-------------|---------------------------|

| | |
|--|-----------------|
| Maximum working voltage for analog inputs (signal + common mode) | ±11 V of AI GND |
|--|-----------------|

| | |
|--------------------|-------|
| CMRR (DC to 60 Hz) | 92 dB |
|--------------------|-------|

Input impedance

Device on

| | |
|---------------|--------------------------------|
| AI+ to AI GND | >10 GΩ in parallel with 100 pF |
|---------------|--------------------------------|

| | |
|---------------|--------------------------------|
| AI- to AI GND | >10 GΩ in parallel with 100 pF |
|---------------|--------------------------------|

Device off

| | |
|---------------|-------|
| AI+ to AI GND | 820 Ω |
|---------------|-------|

| | |
|---------------|-------|
| AI- to AI GND | 820 Ω |
|---------------|-------|

| | |
|--------------------|---------|
| Input bias current | ±100 pA |
|--------------------|---------|

Crosstalk (at 100 kHz)

| | |
|-------------------|--------|
| Adjacent channels | -75 dB |
|-------------------|--------|

| | |
|-----------------------|---------------------|
| Non-adjacent channels | -90 dB ¹ |
|-----------------------|---------------------|

| | |
|--------------------------------|---------|
| Small signal bandwidth (-3 dB) | 700 kHz |
|--------------------------------|---------|

| | |
|-----------------|---------------|
| Input FIFO size | 4,095 samples |
|-----------------|---------------|

| | |
|------------------|---------------|
| Scan list memory | 4,095 entries |
|------------------|---------------|

Data transfers

| | |
|-----------------|--|
| PCI/PXI devices | DMA (scatter-gather), interrupts, programmed I/O |
|-----------------|--|

| | |
|-------------|-----------------------------------|
| USB devices | USB Signal Stream, programmed I/O |
|-------------|-----------------------------------|

Overvoltage protection (AI <0..79>, AI SENSE, AI SENSE 2)

| | |
|-----------|-----------------------------|
| Device on | ±25 V for up to two AI pins |
|-----------|-----------------------------|

| | |
|--|-----------------------------|
| Device off | ±15 V for up to two AI pins |
| Input current during overvoltage condition | ±20 mA max/AI pin |

¹ For USB-6225 devices, channel AI <0..15> crosstalk to channel AI <64..79> is -71 dB; applies to channels with 64-channel separation, for example, AI (x) and AI (x + 64).

Settling Time for Multichannel Measurements

Accuracy, full scale step, all ranges

| | |
|--------------------------|-----------------------|
| ±90 ppm of step (±6 LSB) | 4 μs convert interval |
| ±30 ppm of step (±2 LSB) | 5 μs convert interval |
| ±15 ppm of step (±1 LSB) | 7 μs convert interval |

Typical Performance Graphs

Settling Error Versus Time for Different Source Impedances

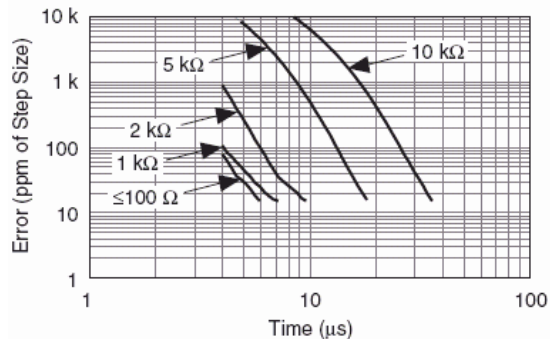

AI <0..79> CMRR

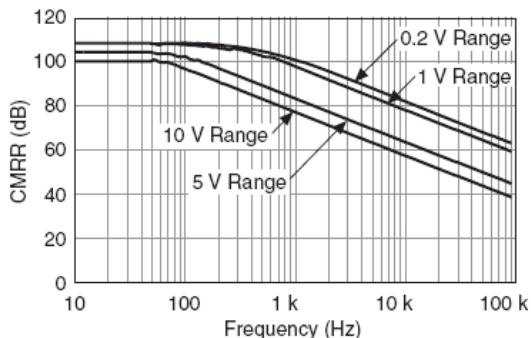

AI <0..79> Small Signal Bandwidth

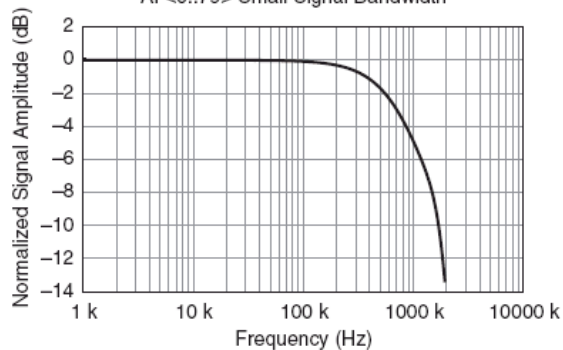

Analog Output

| | |
|---------------------|-----------------------|
| Number of channels | |
| NI 6220/6224 | 0 |
| NI 6221/6225 | 2 |
| NI 6229 | 4 |
| DAC resolution | |
| | 16 bits |
| DNL | |
| | ±1 LSB |
| Monotonicity | |
| | 16 bit guaranteed |
| Maximum update rate | |
| 1 channel | 833 kS/s |
| 2 channels | 740 kS/s per channel |
| 3 channels | 666 kS/s per channel |
| 4 channels | 625 kS/s per channel |
| Timing accuracy | |
| | 50 ppm of sample rate |
| Timing resolution | |
| | 50 ns |

| | |
|--|--|
| Output range | ±10 V |
| Output coupling | DC |
| Output impedance | 0.2 Ω |
| Output current drive | ±5 mA |
| Overdrive protection | ±25 V |
| Overdrive current | 10 mA |
| Power-on state | ±20 mV ² |
| Power-on glitch | 400 mV for 200 ms |
| Output FIFO size | 8,191 samples shared among channels used |
| Data transfers | |
| PCI/PXI devices | DMA (scatter-gather), interrupts, programmed I/O |
| USB devices | USB Signal Stream, programmed I/O |
| AO waveform modes: | |
| Non-periodic waveform | |
| Periodic waveform regeneration mode from onboard FIFO | |
| Periodic waveform regeneration from host buffer including dynamic update | |
| Settling time, full scale step 15 ppm (1 LSB) | 6 μs |
| Slew rate | 15 V/μs |
| Glitch energy | |
| Magnitude | 100 mV |
| Duration | 2.6 μs |

² For all USB-6221/6229 Screw Terminal devices, when powered on, the analog output signal is not defined until after USB configuration is complete.

Calibration (AI and AO)

| | |
|--------------------------|------------|
| Recommended warm-up time | 15 minutes |
| Calibration interval | 1 year |

AI Absolute Accuracy Table

| Nominal Range | | Residual Gain Error (ppm of Reading) | Gain Tempco (ppm/°C) | Reference Tempco | Residual Offset Error (ppm of Range) | Offset Tempco (ppm of Range/°C) | INL Error (ppm of Range) | Random Noise, σ (μVrms) | Absolute Accuracy at Full Scale ¹ (μV) | Sensitivity ² (μV) |
|---------------------|---------------------|--------------------------------------|----------------------|------------------|--------------------------------------|---------------------------------|--------------------------|-------------------------|---|-------------------------------|
| Positive Full Scale | Negative Full Scale | | | | | | | | | |
| 10 | -10 | 75 | 25 | 5 | 20 | 57 | 76 | 244 | 3,100 | 97.6 |
| 5 | -5 | 85 | 25 | 5 | 20 | 60 | 76 | 122 | 1,620 | 48.8 |
| 1 | -1 | 95 | 25 | 5 | 25 | 79 | 76 | 30 | 360 | 12.0 |
| 0.2 | -0.2 | 135 | 25 | 5 | 80 | 175 | 76 | 13 | 112 | 5.2 |

AbsoluteAccuracy = Reading · (GainError) + Range · (OffsetError) + NoiseUncertainty

GainError = ResidualAIGainError + GainTempco · (TempChangeFromLastInternalCal) + ReferenceTempco · (TempChangeFromLastExternalCal)

OffsetError = ResidualAIOffsetError + OffsetTempco · (TempChangeFromLastInternalCal) + INL_Error

NoiseUncertainty = $\frac{\text{RandomNoise} \cdot 3}{\sqrt{100}}$ For a coverage factor of 3 σ and averaging 100 points.

¹ Absolute accuracy at full scale on the analog input channels is determined using the following assumptions:

TempChangeFromLastExternalCal = 10 °C

TempChangeFromLastInternalCal = 1 °C

number_of_readings = 100

CoverageFactor = 3 σ

For example, on the 10 V range, the absolute accuracy at full scale is as follows:

GainError = 75 ppm + 25 ppm · 1 + 5 ppm · 10 GainError = 150 ppm

OffsetError = 20 ppm + 57 ppm · 1 + 76 ppm OffsetError = 153 ppm

$$\text{NoiseUncertainty} = \frac{244 \mu\text{V} \cdot 3}{\sqrt{100}} \quad \text{NoiseUncertainty} = 73 \mu\text{V}$$

$$\text{AbsoluteAccuracy} = 10 \text{ V} \cdot (\text{GainError}) + 10 \text{ V} \cdot (\text{OffsetError}) + \text{NoiseUncertainty} \quad \text{AbsoluteAccuracy} = 3,100 \mu\text{V}$$

² Sensitivity is the smallest voltage change that can be detected. It is a function of noise.

Accuracies listed are valid for up to one year from the device external calibration.

AO Absolute Accuracy Table

| Nominal Range | | Residual Gain Error (ppm of Reading) | Gain Tempco (ppm/°C) | Reference Tempco | Residual Offset Error (ppm of Range) | Offset Tempco (ppm of Range/°C) | INL Error (ppm of Range) | Absolute Accuracy at Full Scale ¹ (μV) |
|---------------------|---------------------|--------------------------------------|----------------------|------------------|--------------------------------------|---------------------------------|--------------------------|---|
| Positive Full Scale | Negative Full Scale | | | | | | | |
| 10 | -10 | 90 | 10 | 5 | 40 | 5 | 128 | 3,230 |

¹ Absolute Accuracy at full scale numbers is valid immediately following internal calibration and assumes the device is operating within 10 °C of the last external calibration. Accuracies listed are valid for up to one year from the device external calibration.

$$\text{AbsoluteAccuracy} = \text{OutputValue} \cdot (\text{GainError}) + \text{Range} \cdot (\text{OffsetError})$$

$$\text{GainError} = \text{ResidualGainError} + \text{GainTempco} \cdot (\text{TempChangeFromLastInternalCal}) + \text{ReferenceTempco} \cdot (\text{TempChangeFromLastExternalCal})$$

$$\text{OffsetError} = \text{ResidualOffsetError} + \text{AOOffsetTempco} \cdot (\text{TempChangeFromLastInternalCal}) + \text{INL_Error}$$

Digital I/O/PFI

Static Characteristics

Number of channels

NI 6220/6221 (68-pin)/6225 24 total
8 (P0.<0..7>) 16 (PFI <0..7>/P1, PFI <8..15>/P2)

PCI-6221 (37-pin) 10 total
2 (P0.<0, 1>) 8 (PFI <0..7>/P1)

NI 6224/6229 48 total
32 (P0.<0..31>) 16 (PFI <0..7>/P1, PFI <8..15>/P2)

Ground reference

D GND

Direction control

Each terminal individually programmable as input or output

Pull-down resistor

50 kΩ typical, 20 kΩ minimum

Input voltage protection³

±20 V on up to two pins

³ Stresses beyond those listed under *Input voltage protection* may cause permanent damage to the device.

Waveform Characteristics (Port 0 Only)

Terminals used

NI 6220/6221 (68-pin)/6225 Port 0 (P0.<0..7>)

PCI-6221 (37-pin) Port 0 (P0.<0, 1>)

NI 6224/6229 Port 0 (P0.<0..31>)

Port/sample size

NI 6220/6221 (68-pin)/6225 Up to 8 bits

PCI-6221 (37-pin) Up to 2 bits

NI 6224/6229 Up to 32 bits

Waveform generation (DO) FIFO

2,047 samples

Waveform acquisition (DI) FIFO

2,047 samples

DI or DO Sample Clock frequency⁴

0 to 1 MHz

Data transfers

PCI/PXI devices DMA (scatter-gather), interrupts, programmed I/O

USB devices USB Signal Stream, programmed I/O

DO or DI Sample Clock source⁵

Any PFI, RTSI, AI Sample or Convert Clock, AO Sample Clock, Ctr *n* Internal Output, and many other signals

⁴ Performance can be dependent on bus latency and volume of bus activity.

⁵ The digital subsystem does not have its own dedicated internal timing engine. Therefore, a sample clock must be provided from another subsystem on the device or an external source.

PFI/Port 1/Port 2 Functionality⁶

| | |
|--------------------------|--|
| Functionality | Static digital input, static digital output, timing input, timing output |
| Timing output sources | Many AI, AO, counter, DI, DO timing signals |
| Debounce filter settings | 125 ns, 6.425 μs, 2.56 ms, disable; high and low transitions; selectable per input |

⁶ Port 2 is not available on PCI-6221 (37-pin) devices.

| Recommended Operation Conditions, PCI/PXI Devices | | |
|---|-------|--------|
| Level | Min | Max |
| Input high voltage (V_{IH}) | 2.2 V | 5.25 V |
| Input low voltage (V_{IL}) | 0 V | 0.8 V |
| Output high current (I_{OH}) | | |
| P0.<0..31> | — | -24 mA |
| PFI <0..15>/P1/P2 | — | -16 mA |
| Output low current (I_{OL}) | | |
| P0.<0..31> | — | 24 mA |
| PFI <0..15>/P1/P2 | — | 16 mA |

| Recommended Operation Conditions, USB Devices | | |
|---|-------|--------|
| Level | Min | Max |
| Input high voltage (V_{IH}) | 2.2 V | 5.25 V |
| Input low voltage (V_{IL}) | 0 V | 0.8 V |
| Output high current (I_{OH}) | | |
| P0.<0..15> | — | -24 mA |
| P0.<16..31> | — | -16 mA |
| PFI <0..15>/P1/P2 | — | -16 mA |
| Output low current (I_{OL}) | | |
| P0.<0..15> | — | 24 mA |
| P0.<16..31> | — | 16 mA |
| PFI <0..15>/P1/P2 | — | 16 mA |

| Electrical Characteristics | | |
|---|-------|--------|
| Level | Min | Max |
| Positive-going threshold (V_{T+}) | — | 2.2 V |
| Negative-going threshold (V_{T-}) | 0.8 V | — |
| Delta VT hysteresis ($V_{T+} - V_{T-}$) | 0.2 V | — |
| I_{IL} input low current ($V_{in} = 0$ V) | — | -10 μA |
| I_{IH} input high current ($V_{in} = 5$ V) | — | 250 μA |

Digital I/O Characteristics⁶

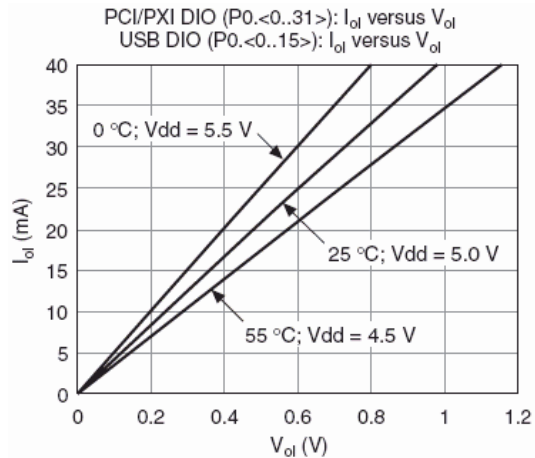
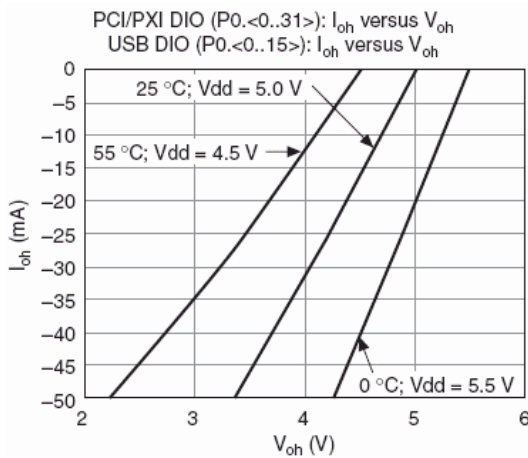

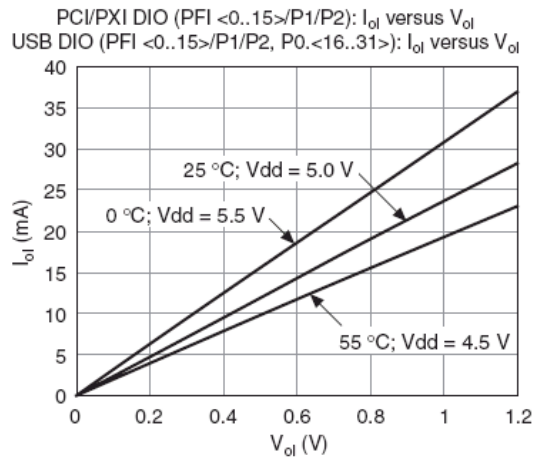
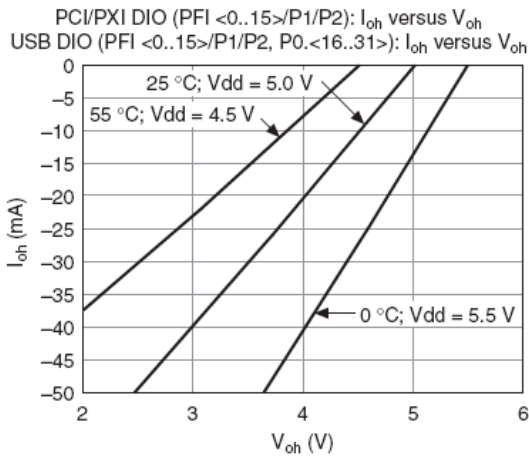

General-Purpose Counter/Timers

| | |
|-------------------------------|--|
| Number of counter/timers | 2 |
| Resolution | 32 bits |
| Counter measurements | Edge counting, pulse, semi-period, period, two-edge separation |
| Position measurements | X1, X2, X4 quadrature encoding with Channel Z reloading; two-pulse encoding |
| Output applications | Pulse, pulse train with dynamic updates, frequency division, equivalent time sampling |
| Internal base clocks | 80 MHz, 20 MHz, 0.1 MHz |
| External base clock frequency | 0 MHz to 20 MHz |
| Base clock accuracy | 50 ppm |
| Inputs | Gate, Source, HW_Arm, Aux, A, B, Z, Up_Down |
| Routing options for inputs | Any PFI, RTSI, PXI_TRIG, PXI_STAR, analog trigger, many internal signals |
| FIFO | 2 samples |
| Data transfers | |
| PCI/PCIe/PXI/PXIe devices | Dedicated scatter-gather DMA controller for each counter/timer; interrupts, programmed I/O |
| USB devices | USB Signal Stream, programmed I/O |

Frequency Generator

| | |
|--|-----------------|
| Number of channels | 1 |
| Base clocks | 10 MHz, 100 kHz |
| Divisors | 1 to 16 |
| Base clock accuracy | 50 ppm |
| Output can be available on any PFI or RTSI terminal. | |

Phase-Locked Loop (PLL)

| | |
|------------------|--|
| Number of PLLs | 1 |
| Reference signal | PXI_STAR, PXI_CLK10, RTSI <0..7> |
| Output of PLL | 80 MHz Timebase; other signals derived from 80 MHz Timebase including 20 MHz and 100 kHz Timebases |

External Digital Triggers

| | |
|------------------------|---|
| Source | Any PFI, RTSI, PXI_TRIG, PXI_STAR |
| Polarity | Software-selectable for most signals |
| Analog input function | Start Trigger, Reference Trigger, Pause Trigger, Sample Clock, Convert Clock, Sample Clock Timebase |
| Analog output function | Start Trigger, Pause Trigger, Sample Clock, Sample Clock Timebase |

| | |
|--|---|
| Counter/timer functions | Gate, Source, HW_Arm, Aux, A, B, Z, Up_Down |
| Digital waveform generation (DO) function | Sample Clock |
| Digital waveform acquisition (DI) function | Sample Clock |
| Device-To-Device Trigger Bus | |
| PCI/PCIe devices | RTSI <0..7> ⁷ |
| PXI/PXIe devices | PXI_TRIG <0..7>, PXI_STAR |
| USB devices | None |
| Output selections | 10 MHz Clock; frequency generator output; many internal signals |
| Debounce filter settings | 125 ns, 6.425 μ s, 2.56 ms, disable; high and low transitions; selectable per input |

⁷ In other sections of this document, *RTSI* refers to RTSI <0..7> for PCI devices or PXI_TRIG <0..7> for PXI devices.

Bus Interface

| | |
|---------------------------------|---|
| PCI/PXI devices | 3.3 V or 5 V signal environment |
| USB devices | USB 2.0 Hi-Speed or full-speed ⁸ |
| DMA channels (PCI/PXI devices) | 6, analog input, analog output, digital input, digital output, counter/timer 0, counter/timer 1 |
| USB Signal Stream (USB devices) | 4, can be used for analog input, analog output, digital input, digital output, counter/timer 0, counter/timer 1 |

All PXI-625x devices support one of the following features:
 May be installed in PXI Express hybrid slots
 Or, may be used to control SCXI in PXI/SCXI combo chassis

⁸ If you are using a USB M Series device in full-speed mode, device performance will be lower and you will not be able to achieve maximum sampling/update rates.

| M Series Device | M Series Part Number | SCXI Control in PXI/SCXI Combo Chassis | PXI Express Hybrid Slot Compatible |
|---|----------------------|--|------------------------------------|
| PXI-6220 | 191332B-04 | No | Yes |
| PXI-6221 | 191332B-03 | No | Yes |
| | 191332B-13 | Yes | No |
| PXI-6224 | 191332B-02 | No | Yes |
| PXI-6225 | 192227A-01 | No | Yes |
| PXI-6229 | 191332B-01 | No | Yes |
| | 191332B-11 | Yes | No |
| Earlier versions of PXI-6220/6221/6224/6229 | 191332A-0x | Yes | No |

Power Requirements

| | |
|---|----------------------|
| Current draw from bus during no-load condition ⁹ | |
| PCI/PXI devices | |
| +5 V | 0.02 A ¹⁰ |
| +3.3 V | 0.25 A ¹⁰ |
| +12 V | 0.15 A |
| Current draw from bus during AI and AO overvoltage condition ⁹ | |
| PCI/PXI devices | |
| +5 V | 0.02 A ¹⁰ |
| +3.3 V | 0.25 A ¹⁰ |
| +12 V | 0.25 A |

 **Caution** USB-622x devices must be powered with NI offered AC adapter or a National Electric Code (NEC) Class 2 DC source that meets the power requirements for the device and has appropriate safety certification marks for country of use.

| | |
|-------------------------------|---|
| USB power supply requirements | 11 to 30 VDC, 20 W, locking or non-locking power jack with 0.080" diameter center pin, 5/16-32 thread for locking collars |
|-------------------------------|---|

⁹ Does not include P0/PFI/P1/P2 and +5 V terminals.

¹⁰ PXI-6221 (37-pin) devices do not use +3.3 V from the bus. The 3.3 V current draw, shown in the *Power Requirements* section, comes from the +5 V instead.

Power Limits

 **Caution** Exceeding the power limits may cause unpredictable behavior by the device and/or PC/chassis.

| | |
|--|-----------------------|
| PCI devices | |
| +5 V terminal (connector 0) | 1 A max ¹¹ |
| +5 V terminal (connector 1) | 1 A max ¹¹ |
| PXI devices | |
| +5 V terminal (connector 0) | 1 A max ¹¹ |
| +5 V terminal (connector 1) | 1 A max ¹¹ |
| P0/PFI/P1/P2 and +5 V terminals combined | 2 A max |
| USB devices | |
| +5 V terminal | 1 A max ¹¹ |
| P0/PFI/P1/P2 and +5 V terminals combined | 2 A max |
| Power supply fuse | 2 A, 250 V |

¹¹ Has a self-resetting fuse that opens when current exceeds this specification.

Physical Requirements

Printed circuit board dimensions

| | |
|------------------------------|-------------------------------|
| PCI-6220/6221/6224/6225/6229 | 9.7 x 15.5 cm (3.8 x 6.1 in.) |
| PXI-6220/6221/6224/6225/6229 | Standard 3U PXI |

Enclosure dimensions (includes connectors)

| | |
|-----------------------------------|---|
| USB-6221/6225/6229 Screw Terminal | 26.67 x 17.09 x 4.45 cm (10.5 x 6.73 x 1.75 in.) |
| USB-6221/6229 BNC | 28.6 x 17 x 6.9 cm (11.25 x 6.7 x 2.7 in.) |
| USB-6225 Mass Termination | 18.8 x 17.09 x 4.45 cm (7.4 x 6.73 x 1.75 in.) |
| USB-6221/6225/6229 OEM | Refer to the <i>NI USB-622x/625x OEM User Guide</i> |

Weight

| | |
|------------------------------|----------------------|
| PCI-6220 | 91 g (3.2 oz) |
| PCI-6221 (68-pin) | 92 g (3.2 oz) |
| PCI-6221 (37-pin) | 95 g (3.3 oz) |
| PCI-6224 | 99 g (3.5 oz) |
| PCI-6225 | 103 g (3.6 oz) |
| PCI-6229 | 101 g (3.5 oz) |
| PXI-6220 | 158 g (5.5 oz) |
| PXI-6221 | 162 g (5.7 oz) |
| PXI-6224 | 170 g (5.9 oz) |
| PXI-6225 | 174 g (6.1 oz) |
| PXI-6229 | 171 g (6.0 oz) |
| USB-6221 Screw Terminal | 1.2 kg (2 lb 10 oz) |
| USB-6225/6229 Screw Terminal | 1.24 kg (2 lb 11 oz) |
| USB-6225 Mass Termination | 907 g (2 lb) |
| USB-6221 OEM | 131 g (4.6 oz) |
| USB-6225/6229 OEM | 162 g (5.7 oz) |

I/O connector

| | |
|------------------------------|--------------------------------|
| PCI/PXI-6220/6221 (68-pin) | 1 68-pin VHDCI |
| PCI/PXI-6224/6225/6229 | 2 68-pin VHDCI |
| PCI-6221 (37-pin) | 1 37-pin D-SUB |
| USB-6221 Screw Terminal | 64 screw terminals |
| USB-6225/6229 Screw Terminal | 128 screw terminals |
| USB-6221 BNC | 21 BNCs and 30 screw terminals |

| | |
|---|--------------------------------|
| USB-6229 BNC | 32 BNCs and 60 screw terminals |
| USB-6225 Mass Termination | 2 68-pin SCSI |
| USB-6221/6225/6229 Screw Terminal/ USB-6221/6229 BNC screw terminal wiring | 16-28 AWG |

Maximum Working Voltage¹²

| | |
|--|------------------------------|
| NI 6220/6221/6224/6225/6229 channel-to-earth | 11 V, Measurement Category I |
|--|------------------------------|

 **Caution** Do *not* use for measurements within Categories II, III, or IV.

¹² *Maximum working voltage* refers to the signal voltage plus the common-mode voltage.

Environmental

Operating temperature

| | |
|------------------------------------|-----------------------------|
| PCI/PXI devices | 0 to 55 °C |
| USB devices | 0 to 45 °C |
| Storage temperature | -20 to 70 °C |
| Humidity | 10 to 90% RH, noncondensing |
| Maximum altitude | 2,000 m |
| Pollution Degree (indoor use only) | 2 |

Shock and Vibration (PXI Devices Only)

| | |
|-------------------|---|
| Operational shock | 30 g peak, half-sine, 11 ms pulse (Tested in accordance with IEC-60068-2-27. Test profile developed in accordance with MIL-PRF-28800F.) |
| Random vibration | |
| Operating | 5 to 500 Hz, 0.3 g _{rms} |
| Nonoperating | 5 to 500 Hz, 2.4 g _{rms} (Tested in accordance with IEC-60068-2-64. Nonoperating test profile exceeds the requirements of MIL-PRF-28800F, Class 3.) |

Safety

This product is designed to meet the requirements of the following standards of safety for electrical equipment for measurement, control, and laboratory use:

IEC 61010-1, EN 61010-1
UL 61010-1, CSA 61010-1

 **Note** For UL and other safety certifications, refer to the product label or visit ni.com/certification, search by model number or product line, and click the appropriate link in the Certification column.

Electromagnetic Compatibility

This product is designed to meet the requirements of the following standards of EMC for electrical equipment for measurement, control, and laboratory use:

EN 61326 EMC requirements; Minimum Immunity
EN 55011 Emissions; Group 1, Class A
CE, C-Tick, ICES, and FCC Part 15 Emissions; Class A

 **Note** For EMC compliance, operate this device with shielded cables.

CE Compliance

This product meets the essential requirements of applicable European Directives, as amended for CE marking, as follows:

73/23/EEC; Low-Voltage Directive (safety)
89/336/EEC; Electromagnetic Compatibility Directive (EMC)

 **Note** Refer to the Declaration of Conformity (DoC) for this product for any additional regulatory compliance information. To obtain the DoC for this product, visit ni.com/certification, search by model number or product line, and click the appropriate link in the Certification column.

Environmental Management

National Instruments is committed to designing and manufacturing products in an environmentally responsible manner. NI recognizes that eliminating certain hazardous substances from our products is beneficial not only to the environment but also to NI customers.

For additional environmental information, refer to the NI and the Environment Web page at ni.com/environment. This page contains the environmental regulations and directives with which NI complies, as well as other environmental information not included in this document.

Waste Electrical and Electronic Equipment (WEEE)



At the end of their life cycle, all products must be sent to a WEEE recycling center. For more information about WEEE recycling centers and National Instruments WEEE initiatives, visit ni.com/environment/weee.htm.

电子信息产品污染控制管理办法（中国 RoHS）



中国客户 National Instruments 符合中国电子信息产品中限制使用某些有害物质指令 (RoHS)。
关于 National Instruments 中国 RoHS 合规性信息，请登录 ni.com/environment/rohs_china。
(For information about China RoHS compliance, go to ni.com/environment/rohs_china.)

[Back to Top](#)

Pinouts/Front Panel Connections

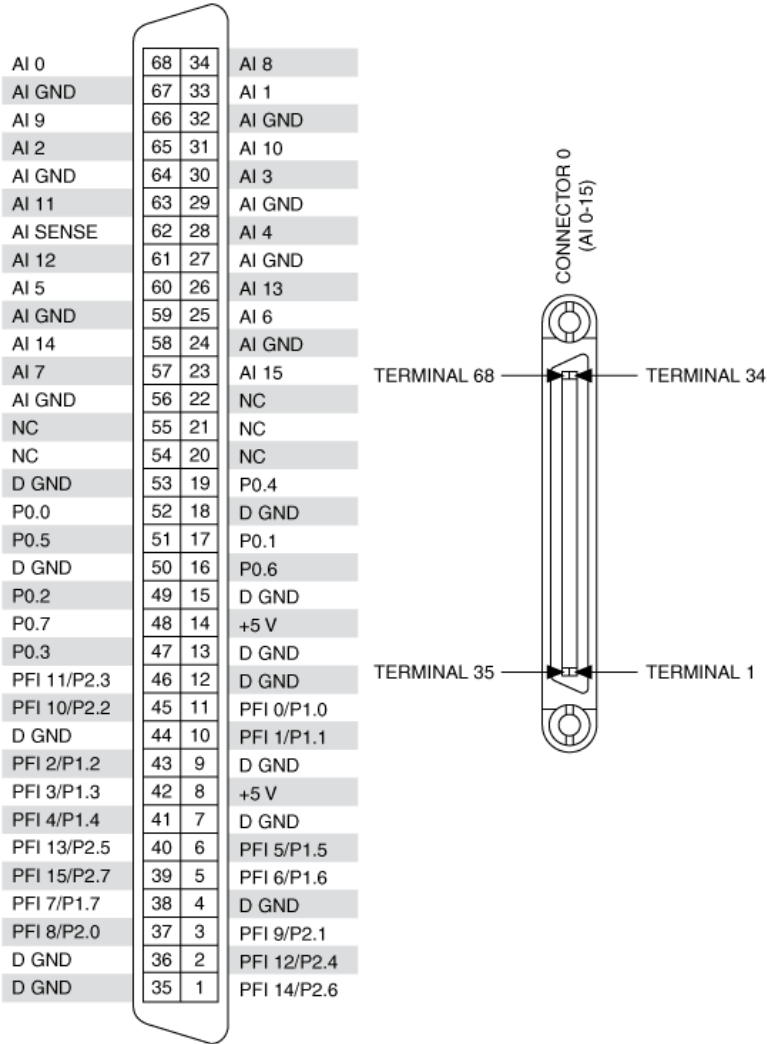

NC = No Connect

PCI/PXI-6220 Pinout

| | | | |
|-------------|----|----|-------------|
| AI 0 | 68 | 34 | AI 8 |
| AI GND | 67 | 33 | AI 1 |
| AI 9 | 66 | 32 | AI GND |
| AI 2 | 65 | 31 | AI 10 |
| AI GND | 64 | 30 | AI 3 |
| AI 11 | 63 | 29 | AI GND |
| AI SENSE | 62 | 28 | AI 4 |
| AI 12 | 61 | 27 | AI GND |
| AI 5 | 60 | 26 | AI 13 |
| AI GND | 59 | 25 | AI 6 |
| AI 14 | 58 | 24 | AI GND |
| AI 7 | 57 | 23 | AI 15 |
| AI GND | 56 | 22 | AO 0 |
| AO GND | 55 | 21 | AO 1 |
| AO GND | 54 | 20 | NC |
| D GND | 53 | 19 | P0.4 |
| P0.0 | 52 | 18 | D GND |
| P0.5 | 51 | 17 | P0.1 |
| D GND | 50 | 16 | P0.6 |
| P0.2 | 49 | 15 | D GND |
| P0.7 | 48 | 14 | +5 V |
| P0.3 | 47 | 13 | D GND |
| PFI 11/P2.3 | 46 | 12 | D GND |
| PFI 10/P2.2 | 45 | 11 | PFI 0/P1.0 |
| D GND | 44 | 10 | PFI 1/P1.1 |
| PFI 2/P1.2 | 43 | 9 | D GND |
| PFI 3/P1.3 | 42 | 8 | +5 V |
| PFI 4/P1.4 | 41 | 7 | D GND |
| PFI 13/P2.5 | 40 | 6 | PFI 5/P1.5 |
| PFI 15/P2.7 | 39 | 5 | PFI 6/P1.6 |
| PFI 7/P1.7 | 38 | 4 | D GND |
| PFI 8/P2.0 | 37 | 3 | PFI 9/P2.1 |
| D GND | 36 | 2 | PFI 12/P2.4 |
| D GND | 35 | 1 | PFI 14/P2.6 |

NC = No Connect

PCI/PXI-6221 (68-Pin) Pinout

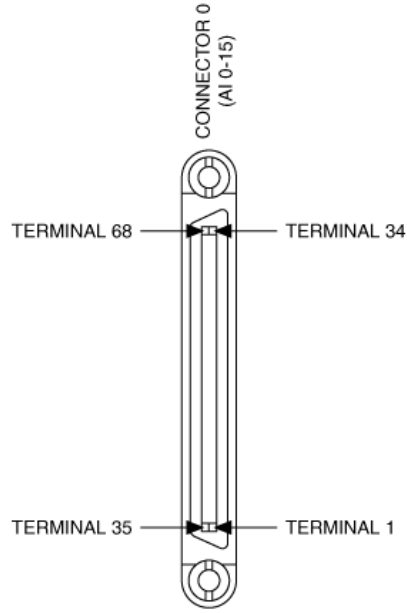

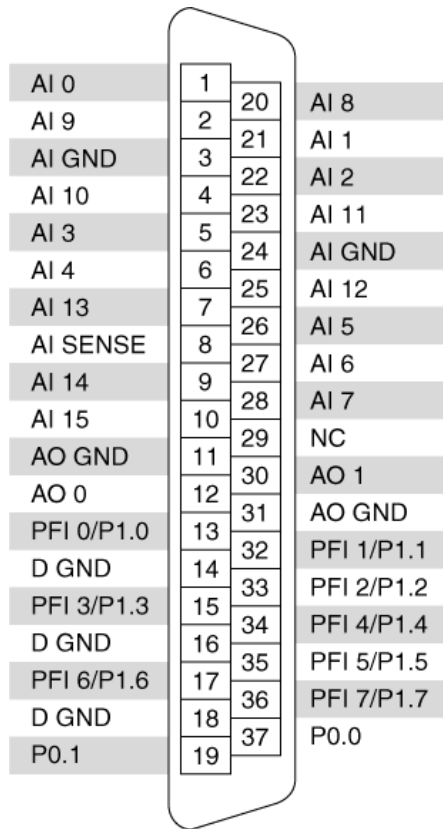

NC = No Connect

PCI-6221 (37-Pin) Pinout

| | | | |
|-------------|----|----|-------------|
| AI 0 | 68 | 34 | AI 8 |
| AI GND | 67 | 33 | AI 1 |
| AI 9 | 66 | 32 | AI GND |
| AI 2 | 65 | 31 | AI 10 |
| AI GND | 64 | 30 | AI 3 |
| AI 11 | 63 | 29 | AI GND |
| AI SENSE | 62 | 28 | AI 4 |
| AI 12 | 61 | 27 | AI GND |
| AI 5 | 60 | 26 | AI 13 |
| AI GND | 59 | 25 | AI 6 |
| AI 14 | 58 | 24 | AI GND |
| AI 7 | 57 | 23 | AI 15 |
| AI GND | 56 | 22 | NC |
| NC | 55 | 21 | NC |
| NC | 54 | 20 | NC |
| D GND | 53 | 19 | P0.4 |
| P0.0 | 52 | 18 | D GND |
| P0.5 | 51 | 17 | P0.1 |
| D GND | 50 | 16 | P0.6 |
| P0.2 | 49 | 15 | D GND |
| P0.7 | 48 | 14 | +5 V |
| P0.3 | 47 | 13 | D GND |
| PFI 11/P2.3 | 46 | 12 | D GND |
| PFI 10/P2.2 | 45 | 11 | PFI 0/P1.0 |
| D GND | 44 | 10 | PFI 1/P1.1 |
| PFI 2/P1.2 | 43 | 9 | D GND |
| PFI 3/P1.3 | 42 | 8 | +5 V |
| PFI 4/P1.4 | 41 | 7 | D GND |
| PFI 13/P2.5 | 40 | 6 | PFI 5/P1.5 |
| PFI 15/P2.7 | 39 | 5 | PFI 6/P1.6 |
| PFI 7/P1.7 | 38 | 4 | D GND |
| PFI 8/P2.0 | 37 | 3 | PFI 9/P2.1 |
| D GND | 36 | 2 | PFI 12/P2.4 |
| D GND | 35 | 1 | PFI 14/P2.6 |

NC = No Connect

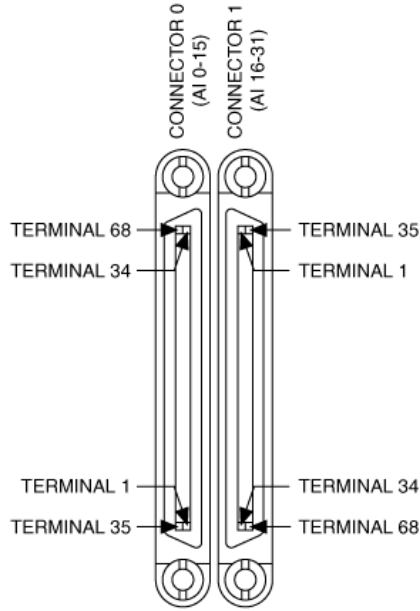

PCI/PXI-6224 Pinout

| | | | |
|--------|----|----|------------|
| P0.30 | 1 | 35 | D GND |
| P0.28 | 2 | 36 | D GND |
| P0.25 | 3 | 37 | P0.24 |
| D GND | 4 | 38 | P0.23 |
| P0.22 | 5 | 39 | P0.31 |
| P0.21 | 6 | 40 | P0.29 |
| D GND | 7 | 41 | P0.20 |
| +5 V | 8 | 42 | P0.19 |
| D GND | 9 | 43 | P0.18 |
| P0.17 | 10 | 44 | D GND |
| P0.16 | 11 | 45 | P0.26 |
| D GND | 12 | 46 | P0.27 |
| D GND | 13 | 47 | P0.11 |
| +5 V | 14 | 48 | P0.15 |
| D GND | 15 | 49 | P0.10 |
| P0.14 | 16 | 50 | D GND |
| P0.9 | 17 | 51 | P0.13 |
| D GND | 18 | 52 | P0.8 |
| P0.12 | 19 | 53 | D GND |
| NC | 20 | 54 | NC |
| NC | 21 | 55 | NC |
| NC | 22 | 56 | AI GND |
| AI 31 | 23 | 57 | AI 23 |
| AI GND | 24 | 58 | AI 30 |
| AI 22 | 25 | 59 | AI GND |
| AI 29 | 26 | 60 | AI 21 |
| AI GND | 27 | 61 | AI 28 |
| AI 20 | 28 | 62 | AI SENSE 2 |
| AI GND | 29 | 63 | AI 27 |
| AI 19 | 30 | 64 | AI GND |
| AI 26 | 31 | 65 | AI 18 |
| AI GND | 32 | 66 | AI 25 |
| AI 17 | 33 | 67 | AI GND |
| AI 24 | 34 | 68 | AI 16 |

NC = No Connect

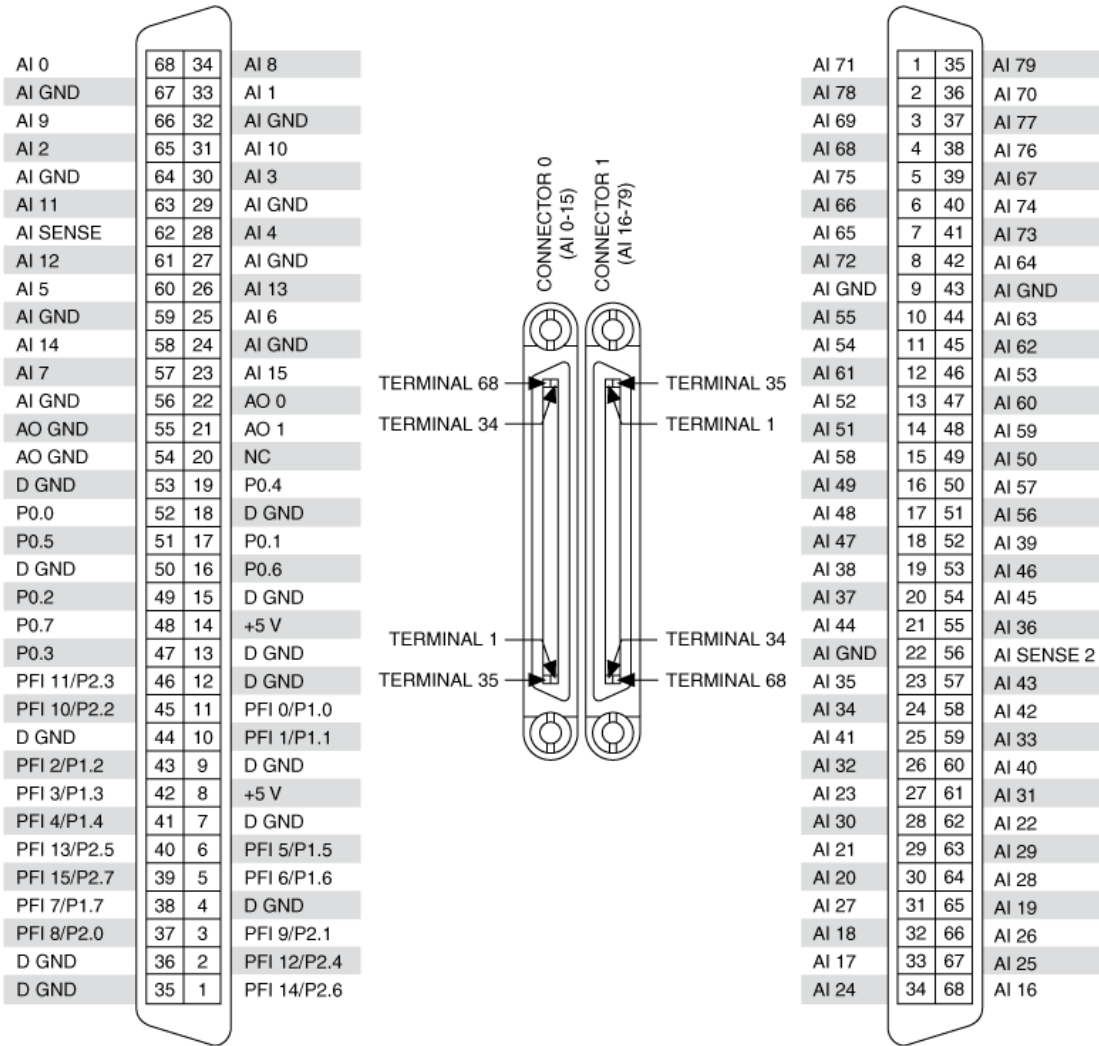

NC = No Connect

PCI/PXI-6225 Pinout

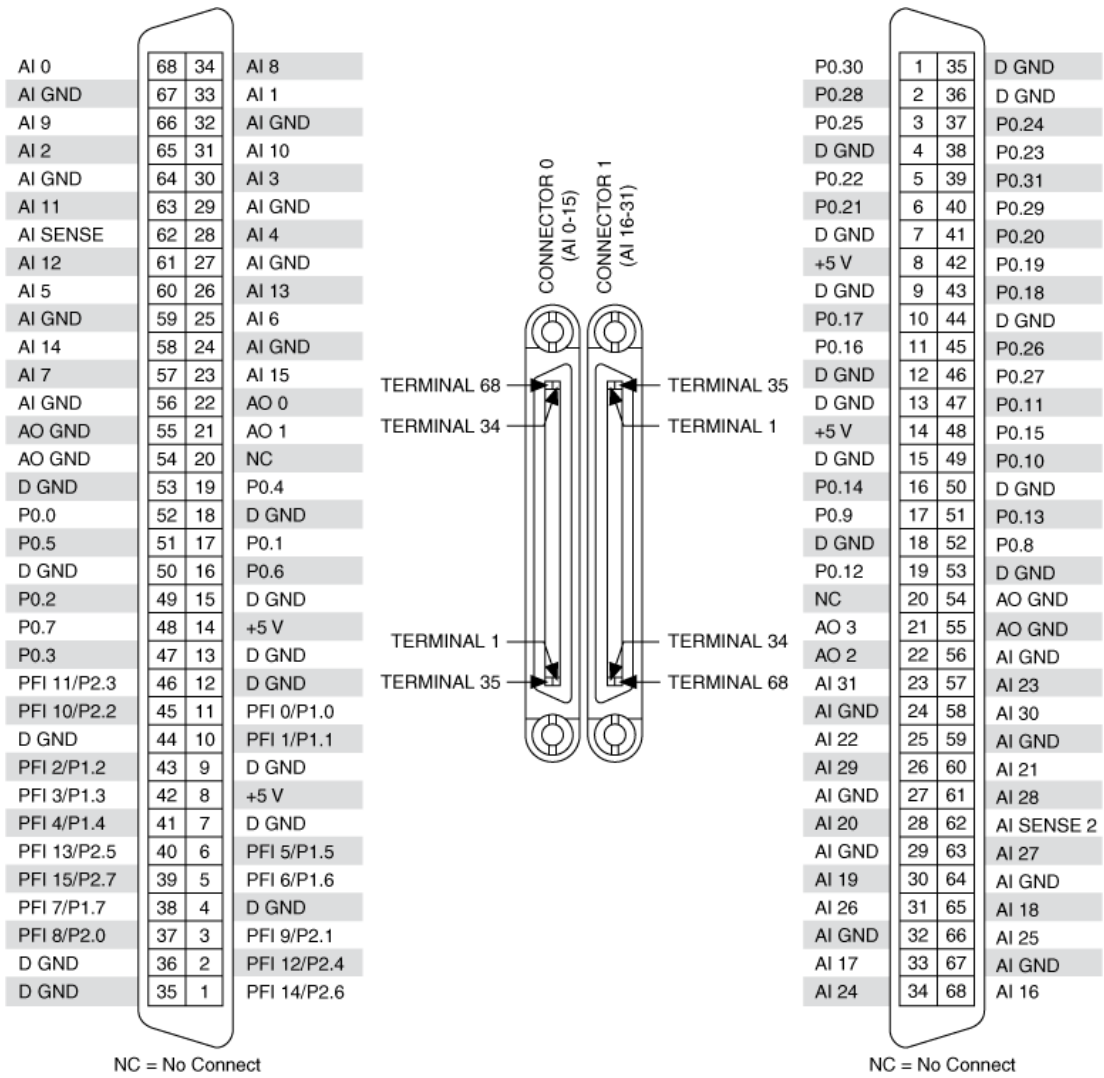

PCI/PXI-6229 Pinout

[Back to Top](#)

©2008 National Instruments. All rights reserved. CVI, LabVIEW, Measurement Studio, National Instruments, NI, ni.com, SCXI, and SignalExpress are trademarks of National Instruments. The mark LabWindows is used under a license from Microsoft Corporation. Windows is a registered trademark of Microsoft Corporation in the United States and other countries. Linux® is the registered trademark of Linus Torvalds in the U.S. and other countries. Other product and company names listed are trademarks or trade names of their respective companies.

[My Profile](#) | [RSS](#) | [Privacy](#) | [Legal](#) | [Contact NI](#) © 2012 National Instruments Corporation. All rights reserved.



Artisan Technology Group is your source for quality new and certified-used/pre-owned equipment

- FAST SHIPPING AND DELIVERY
- TENS OF THOUSANDS OF IN-STOCK ITEMS
- EQUIPMENT DEMOS
- HUNDREDS OF MANUFACTURERS SUPPORTED
- LEASING/MONTHLY RENTALS
- ITAR CERTIFIED SECURE ASSET SOLUTIONS

SERVICE CENTER REPAIRS

Experienced engineers and technicians on staff at our full-service, in-house repair center

*InstraView*SM REMOTE INSPECTION

Remotely inspect equipment before purchasing with our interactive website at www.instraview.com ↗

WE BUY USED EQUIPMENT

Sell your excess, underutilized, and idle used equipment. We also offer credit for buy-backs and trade-ins. www.artisanng.com/WeBuyEquipment ↗

LOOKING FOR MORE INFORMATION?

Visit us on the web at www.artisanng.com ↗ for more information on price quotations, drivers, technical specifications, manuals, and documentation

Contact us: (888) 88-SOURCE | sales@artisanng.com | www.artisanng.com