



www.DanaherMotion.com

Installation Instructions For SLO-SYN[®] Models SS2000MD7 & SS2000MD7-128 Translator/Drive

Document Number: 400030-035
Rev K



Copyright Information

© Copyright 1998 - 2003 Danaher Motion - All rights reserved.
Printed in the United States of America.

NOTICE:

Not for use or disclosure outside of Danaher Motion except under written agreement. All rights are reserved. No part of this book shall be reproduced, stored in retrieval form, or transmitted by any means, electronic, mechanical, photocopying, recording, or otherwise without the written permission from the publisher. While every precaution has been taken in the preparation of the book, the publisher assumes no responsibility for errors or omissions. Neither is any liability assumed for damages resulting from the use of the information contained herein.

This document is proprietary information of Danaher Motion that is furnished for customer use ONLY. No other uses are authorized without written permission of Danaher Motion. Information in this document is subject to change without notice and does not represent a commitment on the part of Danaher Motion. Therefore, information contained in this manual may be updated from time-to-time due to product improvements, etc., and may not conform in every respect to former issues.

SAFETY

Before installing and operating your SLO-SYN motion control product, it is extremely important that you read and understand this safety section. The SLO-SYN product will deliver years of reliable, trouble-free, safe operation if you heed the cautions and warnings as well as follow the instructions contained in this manual.

Safe symbols used in this manual are:



Warnings are provided to alert you to possible damage to equipment and potential electrical shock hazards to personnel.



Cautions are provided to alert you to possible damage to equipment.



Notes alert you to helpful information.

GENERAL SAFETY INFORMATION

Dangerous voltages, currents, temperatures, and energy levels exist within this unit, on certain accessible terminals, and at the motor. NEVER operate the unit with its protective cover removed! Exercise caution when installing and using this unit. Only qualified personnel should attempt to install and/or operate this product. It is essential that proper electrical practices, applicable electrical codes, and the information in this manual be strictly followed.



Dangerous high voltages exist in this product. Be certain the power has been removed for a minimum of five (5) minutes before any service work or circuit board configuration changes are performed.



Voltage is present on unprotected pins when the unit is operational.



The "PWR ON" LED must be off for approximately 30 seconds before making or breaking the motor connections.



Motors powered by this drive may develop extremely high torque. Be sure to disconnect power to this drive BEFORE doing any mechanical work.



This unit is designed for 24 to 75 VDC input only (See Electrical Specifications).



Reconfiguration of the circuit in ANY way not shown in this manual voids the warranty.



Failure to follow the installation instructions in this manual voids the warranty.

Customer Support Contact Information

Danaher Motion products are available nationwide through an extensive authorized distributor network. These distributors offer literature, technical assistance and a wide range of models off the shelf for fastest possible delivery.

Danaher Motion sales engineers are conveniently located to provide prompt attention to customers' needs. Call the nearest office listed for ordering and application information or for the address of the closest authorized distributor.

In the US and Canada

13500-J South Point Blvd.

Charlotte, NC 28273

Phone: (704) 588-5693

Fax: (704) 588-5695

Email: sales2@danahermotion.com

Web: www.DanaherMotion.com

In Europe

Danaher Motion GmbH & Co. KG

Robert-Bosch-Straße 10

64331 Weiterstadt, Germany

Phone: +49 (0) 6151-8796-10

Fax: +49 (0) 6151-8796-123

Web: www.DanaherMotion.de

Table of Contents

| | |
|---|-----------|
| 1. INTRODUCTION | 1 |
| 1.1. PRODUCT FEATURES..... | 1 |
| 2. QUICK START | 2 |
| 3. INSTALLATION | 3 |
| 3.1. MOUNTING | 3 |
| 3.2. CONNECTOR LOCATIONS AND PIN ASSIGNMENTS | 4 |
| 3.2.1. <i>MOTOR CONNECTIONS</i> | 5 |
| 3.2.2. <i>MOTOR WIRING CONFIGURATIONS</i> | 6 |
| 3.2.3. <i>POWER INPUT</i> | 7 |
| 4. HARDWARE SPECIFICATIONS | 9 |
| 4.1. MECHANICAL | 9 |
| 4.2. ELECTRICAL | 9 |
| 4.3. ENVIRONMENTAL | 9 |
| 4.4. MOTOR COMPATIBILITY | 9 |
| 4.5. CURRENT SETTINGS..... | 11 |
| 4.6. STEP RESOLUTION..... | 11 |
| 4.7. SIGNAL SPECIFICATIONS..... | 12 |
| 4.7.1. <i>CONNECTOR PIN ASSIGNMENTS</i> | 12 |
| 4.7.2. <i>SIGNAL DESCRIPTIONS</i> | 12 |
| 4.7.3. <i>LEVEL REQUIREMENTS</i> | 13 |
| 4.7.4. <i>TIMING REQUIREMENTS</i> | 13 |
| 4.8. INDICATOR LIGHTS | 15 |
| 5. TORQUE VERSUS SPEED CHARACTERISTICS | 16 |
| 5.1. MOTOR PERFORMANCE | 16 |
| 5.2. TYPICAL TORQUE VERSUS SPEED CURVES | 17 |
| 6. TROUBLESHOOTING | 30 |
| 6.1. IN GENERAL | 30 |
| 6.2. SPECIFICALLY..... | 30 |

APPENDIX A: TROUBLESHOOTING ELECTRICAL INTERFERENCE 31

1. INTRODUCTION

It is important that you understand how this SLO-SYN® SS2000MD7 Translator/Drive is installed and operated before you attempt to use it. **We strongly recommend that you read this manual completely before proceeding with the installation of this unit.**

This manual is an installation and operation guide to the SLO-SYN SS2000MD7 (MD7-128) Translator Drive. Section 1 provides an overview of the drive and its features. Section 2 lists the steps necessary to place the drive into operation. General wiring information and the physical mounting of the unit and connections to the drive are covered in Section 3.

The complete specifications provide easily-referenced information concerning electrical, mechanical, and environmental requirements as well as information for setting the motor current level.

Torque versus speed characteristics with appropriate SLO-SYN stepper motors are shown in Section 5. Troubleshooting in Section 6 provides procedures to follow if the Translator/Drive fails to operate properly.

1.1. Product Features

The SLO-SYN SS2000MD7 (MD7-128) Translator/Drive is a bipolar, speed adjustable, two-phase PWM drive that uses power MOSFET devices. The MD7 is set to operate a stepper motor in 1/2, 1/10, 1/25, or 1/100 microsteps. The MD7-128 is set to operate a stepper motor in full, 1/16, 1/64, or 1/128 microsteps. The maximum running speed is 3,000 rpm. To reduce the chances of electrical noise, the control signals are optically isolated from the drive circuit.

- UL-recognized under Component Program, File #E146240
- Switch-selectable current levels of 1 through 7 amps
- Full short-circuit protection (phase-to-phase and phase-to-ground)
- Undervoltage and transient overvoltage protection
- Thermal protection
- Efficient thermal design
- Optically-isolated inputs
- Current and Windings Off reduction capabilities
- Switch-selectable step resolution
- Compact size
- Sturdy all aluminum case

2. QUICK START

The following instructions are the minimum steps necessary to make your drive operational.



Always disconnect the power to the unit and be certain that the "PWR ON" LED is OFF before connecting or disconnecting the motor leads. FAILURE TO DO THIS RESULTS IN A SHOCK HAZARD AND MAY DAMAGE THE DRIVE.



Always operate the unit with the motor and drive enclosure GROUNDED. Be sure to twist the wires together for each motor phase as well as those for the DC input. Six twists per foot is a good guideline.

1. Check to see that the motor is compatible with the drive. Refer to Section 4.4 for a list of compatible motors.
2. Set the correct current level for the motor per the instructions in Section 4.5. **Heat sinking is required if a current of 4 amps or higher is used.**
3. Select the appropriate step resolution and set the switches (Section 4.6).
4. Wire the motor per Section 3.2.
5. Connect the power source to the DC input terminal strip. Be sure to follow the instructions for connecting the filter capacitor as instructed in Section 3.2.



If the motor operates erratically, refer to Section 5.



Clockwise and counter-clockwise directions are properly oriented when viewing the motor from the end OPPOSITE the mounting flange.

3. INSTALLATION

3.1. Mounting

The SLO-SYN drive is mounted by fastening its mounting brackets to a flat surface (shown below). If the Heat Sink Assembly (part number 221576-001) is mounted against a bulkhead, apply a thin coating to thermal compound between the heat sink and the mounting surface before fastening the unit in place. **DO NOT** use too much thermal compound. It is better to use too little than too much.

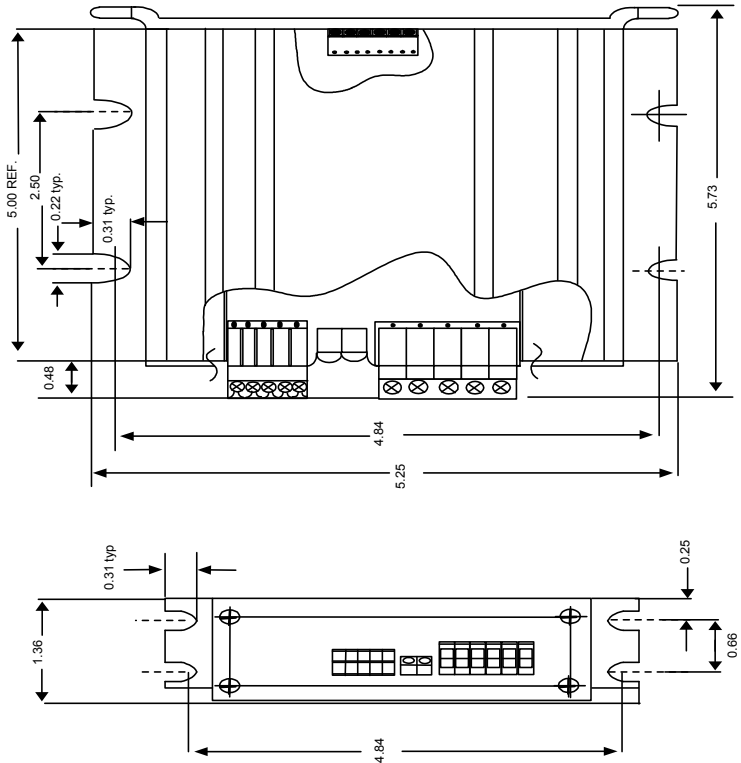

Case temperature should not exceed +70° C (+158° F). A heat sink, such as Superior Electric Heat Sink Assembly 221576-001, must be used when the drive is operated at a current setting of 4 amps or more. In this case, mount the unit upright (with the cooling fins vertical) or proper cooling will not occur. Airflow should not be obstructed. Forced air cooling may be required to maintain temperature within the stated limits.



When selecting a mounting location, it is important to leave at least two inches (51 mm) of space around the top, bottom, and sides of the unit to allow proper airflow for cooling.

It is also important to keep the drive away from obvious noise sources. If possible, locate the drive in its own metal enclosure to shield it and it's wiring from electrical noise sources. If this is not possible, keep the drive at least three feet from any noise sources.

3.2. Connector Locations and Pin Assignments

The figure below shows the connector locations for the SLO-SYN SS2000MD7 (MD7-128) Translator/Drive.



3.2.1. Motor Connections

All motor connections are made via the 6-pin connector, part number 218397-006. Pin assignments for this connector are given below. Motor connections are shown in the next figure.

| <u>Pin</u> | <u>Assignment</u> |
|------------|-------------------|
| 1 | M1 (Phase A) |
| 2 | M3 (Phase A) |
| 3 | M4 (Phase B) |
| 4 | M5 (Phase B) |



*Motor Phase A is M1 and M3. Motor Phase B is M4 and M5. The motor frame **MUST** be grounded.*

Cabling from the drive to the motor should be with a shielded, twisted-pair cable. As a guideline, the wires for each motor phase should be twisted about six times per foot.

Danaher Motion Superior Electric offers the following motor cable configurations. These cables have unterminated leads on both ends.

| <u>Length</u> | <u>Part Number</u> |
|----------------|--------------------|
| 10 ft (3 m) | 216022-031 |
| 25 ft (7.6 m) | 216022-032 |
| 50 ft (15.2 m) | 216022-033 |
| 75 ft (22.8 m) | 216022-034 |

3.2.2. Motor Wiring Configurations

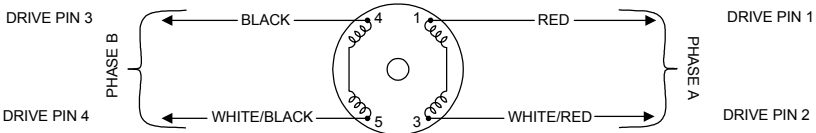

4-LEAD MOTORS

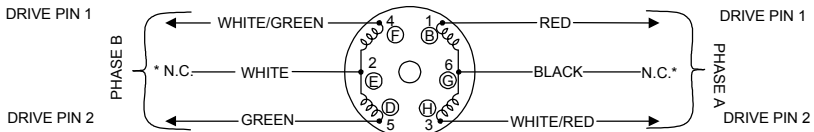

6-LEAD MOTORS

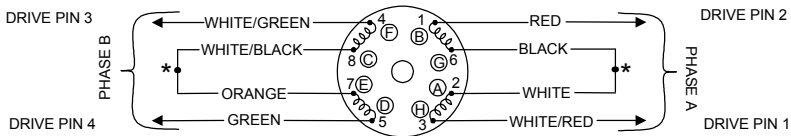

8-LEAD MOTORS, SERIES CONNECTIONS

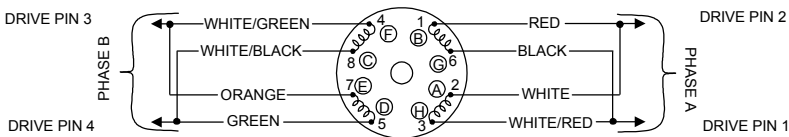

8-LEAD MOTORS, PARALLEL CONNECTIONS

* These leads must be insulated and isolated from other leads or ground.



Circled letters identify terminals for connector motors, numbers identify those for terminal box motors.

3.2.3. Power Input

The DC input power is connected to pins 5 and 6 of the power connector. Pin 5 [Vm(+)] is the power supply plus (+) connection and pin 6 [Vm(-)] is the power supply minus (-) connection.

An unregulated supply similar to the one shown below is preferable. If a regulated supply is used, it must be a linear regulated supply and capable of operating with the added filter capacitor. A switching regulated supply is NOT recommended for use with this drive. It is important that capacitor C1 be connected within three feet (0.9 m) of the input terminals. The capacitor must be of the correct value and have the proper current and voltage parameters (see component list).

It is recommended that the power supply leads be twisted together (6 twists per foot).



If the power supply is grounded, it must only be grounded on the negative side or the short circuit protection does not operate properly.

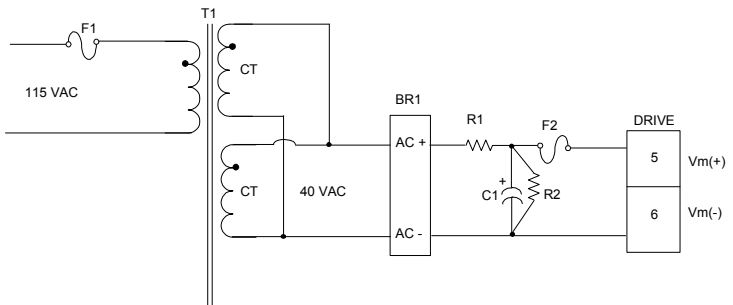

The cable between the filter capacitor (C1) and the drive should be twisted six times per foot. Maximum wire length is three feet. Use #16 AWG or larger wire.

Component List

| 5 amp or lower setting | |
|-------------------------------|--|
| F1 | 3 amp time delay, Bussman MDA-3 or equivalent. |
| F2 | 15 amp very fast acting, Bussman GBB-15 or equivalent. |
| R1 | 5 Ω surge limiter, Phillips 2322-654-61508 or equivalent. |
| F2 | 4.7 k Ω , 2 watts, $\pm 5\%$. |
| T1 | 160 VA Bicon Electronics BU216AS040D, Signal Transformer 80-2 or equivalent. |
| BR1 | General Instrument GBPC3502 or equivalent. |
| C1 | 4700 μf, 6.9 amp ripple current, 100 VDC, United Chemi-Con 36DA472F100AL2A or equivalent. |

| 6 and 7 amp settings | |
|-----------------------------|--|
| F1 | 6 amp time delay, Bussman MDA-6 or equivalent. |
| F2 | 15 amp very fast acting, Bussman GBB-15 or equivalent. |
| R1 | 4 Ω surge limiter, Phillips 2322-654-61408 or equivalent. |
| F2 | 4.7 k Ω , 2 watts, $\pm 5\%$. |
| T1 | 320 VA Bicon Electronics BU233AS040D, Signal Transformer 80-2 or equivalent. |
| BR1 | General Instrument GBPC3502 or equivalent. |
| C1 | 6800 μf, 9.4 amp ripple current, 100 VDC, United Chemi-Con 36DA682F100Ad2A or equivalent. |

4. HARDWARE SPECIFICATIONS

4.1. Mechanical

| | | |
|--------|----------|---------------------------|
| Size | (Inches) | 4.375 H x 1.36 W x 5.73 D |
| | (mm) | 111 H x 35 W x 146 D |
| Weight | (pounds) | 1.5 |
| | (grams) | 680 |

4.2. Electrical

| | |
|---|----------------------|
| DC Input Range (VDC) | 24 (Min) to 75 (Max) |
| AC Current | (see Motor Table) |
| Drive Power Dissipation Worst Case (watts) | 40 |

4.3. Environmental

| | |
|-----------------------|---|
| Operating Temperature | Free air ambient, Natural Convection. Maximum heat sink temperature of 158° F (70° C) must be maintained. Forced air cooling may be required. |
| Fahrenheit | +32° to +122° |
| Celsius | 0° to +50° |
| Storage Temperature | |
| Fahrenheit | -40° to +167° |
| Celsius | -40° to +75° |
| Humidity | 95% maximum, non-condensing |
| Altitude | 10,000 feet (3048 meters) maximum |

4.4. Motor Compatibility

| | |
|-----------------------|---|
| Motor Types | Danaher Motion Superior Electric M and KM Series |
| Frame Sizes | |
| M Series | M061 (NEMA 23D) through M092 (NEMA 34) |
| KM Series | KML060 (NEMA 23) through KML093 (NEMA 34) |
| Number of Connections | 4, 6, 8 |
| Maximum Inductance | 1 millihenry |
| Maximum Resistance | = 0.25 x VDC Supply / I Setting |
| Example: | VDC = 60 I Setting = 7 R max. = 0.25 x 60 / 7 = 2.1 Ω |



Maximum resistance is the total of the motor plus the cable.



Do NOT use larger frame size motor than those listed or the drive may be damaged. If a larger frame size motor must be used, consult the factory for recommendations.

MOTORS FOR USE WITH THE SS2000MD7 TRANSLATOR/DRIVE

| Motor | Winding | Connection | Current Setting (amperes) | Power Supply Current | |
|-----------|---------|------------|---------------------------|----------------------|---------------|
| | | | | Standstill (ADC) | Maximum (ADC) |
| M061 | 08 | Series | 3 | 1.0 | 2.0 |
| M062 | 09 | Series | 3 | 1.0 | 2.0 |
| M062 | 09 | Parallel | 6 | 1.5 | 4.0 |
| M063 | 09 | Series | 3 | 1.0 | 2.0 |
| M063 | 09 | Parallel | 6 | 1.5 | 4.0 |
| M091 | 09 | Series | 4 | 1.5 | 2.0 |
| M091 | 09 | Parallel | 6 | 1.5 | 4.0 |
| M092 | 09 | Series | 4 | 2.0 | 2.0 |
| M092 | 09 | Parallel | 7 | 2.0 | 4.0 |
| M093 | 14 | Series | 5 | 2.0 | 2.0 |
| M093 | 14 | Parallel | 7 | 2.0 | 4.0 |
| KML060F05 | - | - | 3 | 1.0 | 2.0 |
| KML060F08 | - | - | 4 | 1.0 | 2.0 |
| KML061F05 | - | - | 3 | 1.0 | 2.0 |
| KML061F07 | - | - | 3 | 1.0 | 3.5 |
| KML062F13 | - | - | 6 | 1.5 | 4.5 |
| KML063F07 | - | - | 3 | 1.0 | 2.0 |
| KML063F13 | - | - | 7 | 2.0 | 4.5 |
| KML091F07 | - | - | 4 | 1.5 | 2.5 |
| KML091F13 | - | - | 6 | 1.5 | 4.0 |
| KML092F07 | - | - | 4 | 2.0 | 2.0 |
| KML092F13 | - | - | 7 | 2.0 | 4.5 |
| KML093F07 | - | - | 4 | 2.0 | 2.0 |
| KML093F14 | - | - | 7 | 2.0 | 4.5 |



Power supply currents shown are measured at the output of the rectifier bridge.

M061, M062, and M063 motor listed include LS, LE, CS, FC, and FD versions. M091, M092, and M093 motors include FC and FD versions with 6 or 8 leads. Motors with windings other than those listed can be used as long as the current ratings listed on the motors are NOT exceeded. **Consult the factory for recommendations concerning the use of M111 and M112 frame size motors.**

4.5. Current Settings

The proper current setting for each motor is shown on the individual torque vs. speed curve. Use this current level to obtain the torque shown. The access hole for the switches that set the motor current level is located on the back of the unit (see next figure). Switches 1 through 6 are used to select the current level. Select the desired operating current by setting the appropriate switch to position 1 (ON). The OFF position is labeled "0." Only one switch should be ON. If two or more switches are ON, the one selecting the highest current level is the active switch. The switch settings are:

| <u>Position</u> | <u>Current (amps)</u> |
|-----------------|-----------------------|
| None | 1.0 |
| 1 | 2.0 |
| 2 | 3.0 |
| 3 | 4.0* |
| 4 | 5.0* |
| 5 | 6.0* |
| 6 | 7.0* |

** Heat sinking is recommended at current settings of 4 amps or higher. The drive case temperature MUST NOT exceed 70° C.*

4.6. Step Resolution

The number of pulses per revolution is selected using positions 7 and 8 of the switch described in Section 4.5. The following chart shows the correct switch setting for each available step resolution.

| <u>Switch Position</u> | | <u>Step Resolution</u> | | <u>Pulses Per Revolution</u> | |
|------------------------|----------|------------------------|----------------|------------------------------|----------------|
| <u>7</u> | <u>8</u> | <u>MD7</u> | <u>MD7-128</u> | <u>MD7</u> | <u>MD7-128</u> |
| 0 | 0 | 1/2 | Full | 400 | 200 |
| 1 | 0 | 1/10 | 1/16 | 2,000 | 3,200 |
| 0 | 1 | 1/25 | 1/64 | 5,000 | 12,800 |
| 1 | 1 | 1/100 | 1/128 | 20,000 | 25,600 |



4.7. Signal Specifications

4.7.1. Connector Pin Assignments

All connections are made via the 5-pin connector, part number 221536-005.

| <u>Pin</u> | <u>Assignment</u> |
|------------|-------------------|
| 1 | OPTO |
| 2 | PULSE |
| 3 | DIR |
| 4 | AWO |
| 5 | RDCE |

4.7.2. Signal Descriptions

| | |
|-------|--|
| OPTO | Opto-Isolator Supply User supplied power for the opto-isolators. |
| PULSE | Pulse Input A low-to-high transition on this pin advances the motor one step. The step size is determined by the Step Resolution switch setting. |
| DIR | Direction Input When this signal is high, motor rotation is clockwise. Rotation is counter-clockwise when this signal is low. |
| AWO | All Windings Off Input When this signal is low, AC and DC current to the motor is zero. There is NO holding torque when the AWO signal is low. |
| RDCE | Reduce Current Input The motor current is 50% of the selected value when this signal is low. Holding torque is also reduced when this signal is low. |



If you are using the drive with an SS2001 or SS2001-V control, the READY input and the OPTO input on the control MUST be jumpered together.

4.7.3. Level Requirements

OPTO

| | |
|---------------|-----------------------|
| Voltage (VDC) | 4.5 to 6.0 |
| Current | 16 mA per signal used |

Other Signals

Voltage

| | | |
|-------------|--------|---------------|
| Low | \leq | 0.8 VDC |
| | \leq | 0.0 VDC |
| High | \leq | OPTO |
| | \leq | OPTO – 1 volt |

Current

| | | |
|-------------|--------|--------|
| Low | \leq | 16 mA |
| High | \leq | 0.2 mA |

4.7.4. Timing Requirements

PULSE

| | |
|--------------------------|-----------|
| Max. Frequency | 500 kHz |
| Max. Rise and Fall Times | 1 μ s |
| Min. Pulse Width | 1 μ s |

Other Signals

| | |
|---------------|-------------------|
| Response Time | \leq 50 μ s |
|---------------|-------------------|

Suggested Methods For Control Interface

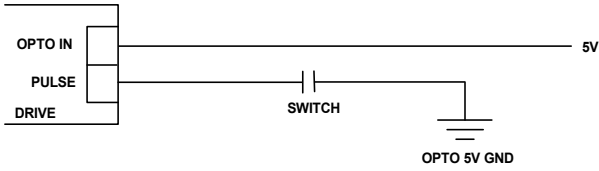
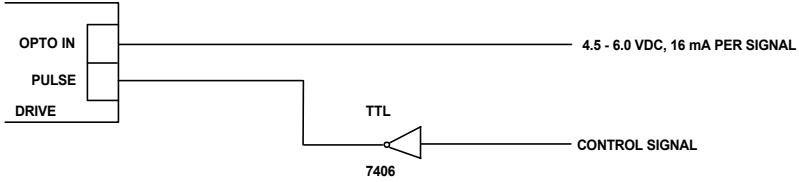
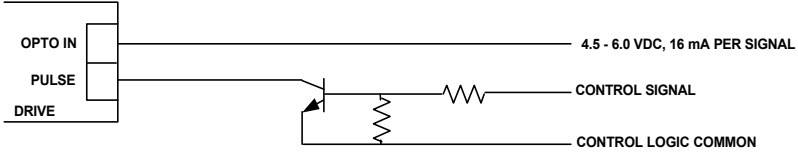
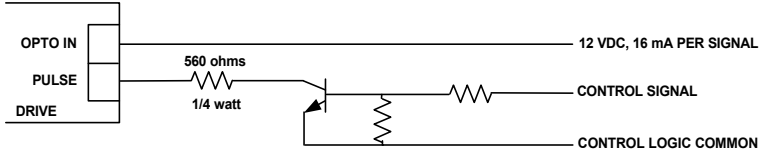

4.8. Indicator Lights

"POWER" LED, Red

Lights when the drive logic power supply is present, indicating that the drive is energized.

"FAULT" LED, Red

Lights to indicate over current condition. This condition is a result of motor winding errors or a ground fault.

Lights also indicate the heat sink temperature has exceeded a safe level for reliable operation.

Recovery from over-current or over-temperature condition requires removing and then reapplying power.

5. TORQUE VERSUS SPEED CHARACTERISTICS

5.1. Motor Performance

All stepper motors exhibit instability at their natural frequency and harmonics of that frequency. Typically, this instability occurs at speeds between 50 and 1000 full steps per second and, depending on the dynamic motor parameters, causes excessive velocity modulation or improper positioning. This type of instability is represented by the open area at the low end of each Torque vs. Speed curve.

There are also other instabilities that cause a loss of torque at stepping rates outside the range of natural resonance frequencies. One such instability is broadly defined as mid-range instability. Usually, the damping of the system and acceleration/deceleration through the resonance areas aid in reducing instability to a level that provides smooth shaft velocity and accurate positioning. If instability does cause unacceptable performance under actual operating conditions, the following techniques can be used to reduce velocity modulation.

1. Avoid constant speed operation at the motor's unstable frequencies. Select a base speed that is above the motor's resonant frequencies and adjust acceleration and deceleration to move the motor through unstable regions quickly.
2. The motor winding current can be reduced as described in Section 4.5. Lowering the current reduces torque proportionally. The reduced energy delivered to the motor can decrease velocity modulation.
3. Use microstepping to provide smoother operation and reduce the effects of mid-range instability. Microstepping reduces the shaft speed for a given pulse input rate.

5.2. Typical Torque Versus Speed Curves



The test conditions used when obtaining the torque versus speed data are listed in the lower left-hand corner of each curve.

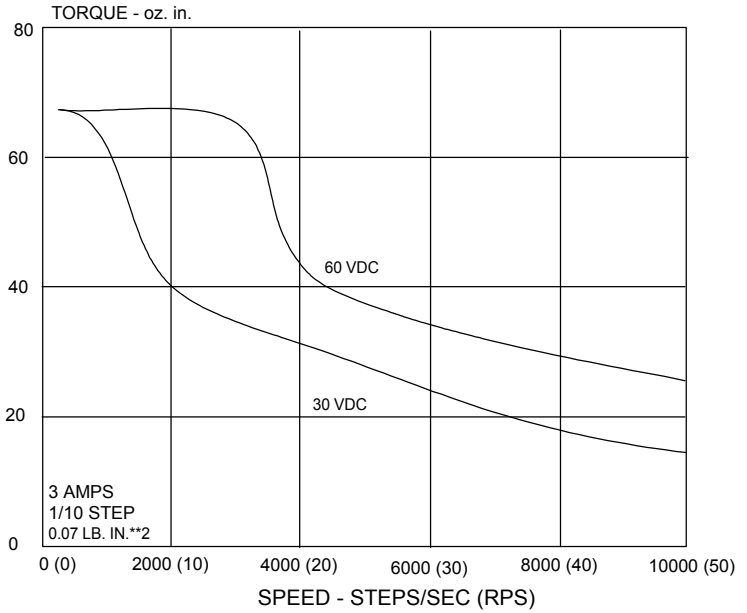

M061-LE08 MOTOR, 3 AMPS SERIES CONNECTION

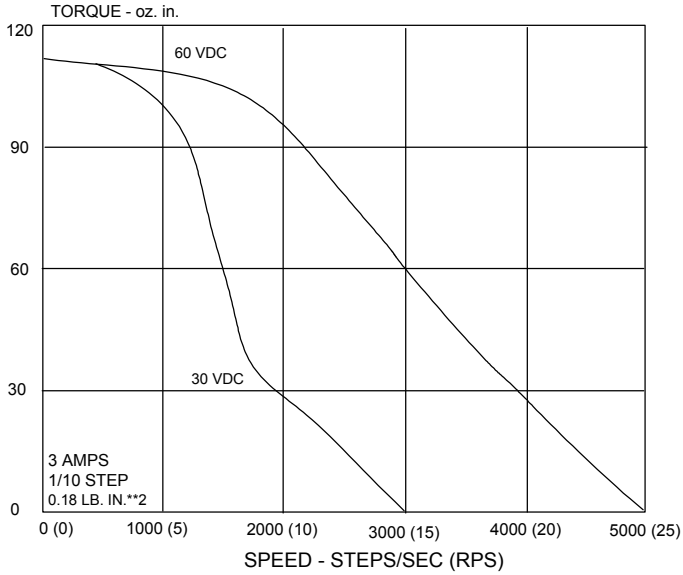

M062-LE09 MOTOR, 3 AMPS SERIES CONNECTION

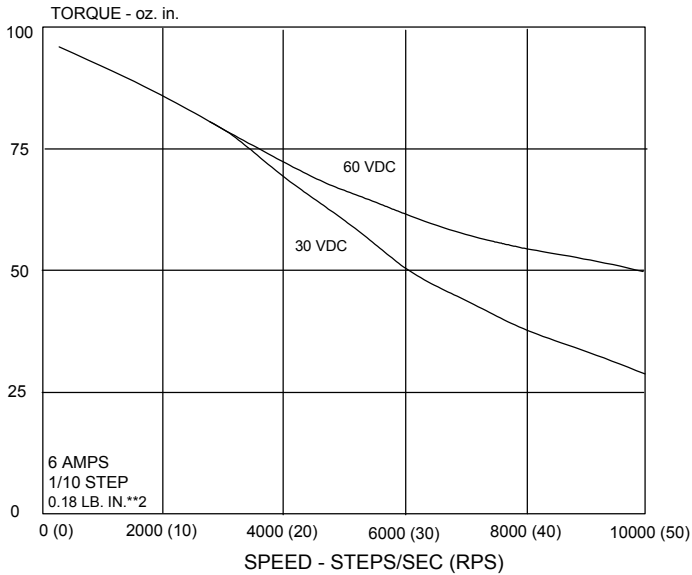

M062-LE09 MOTOR, 6 AMPS PARALLEL CONNECTION

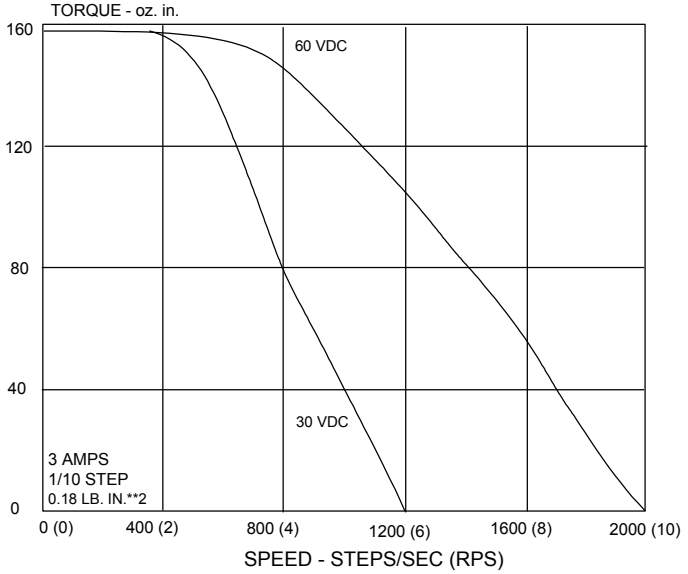

M063-LE09 MOTOR, 3 AMPS SERIES CONNECTION

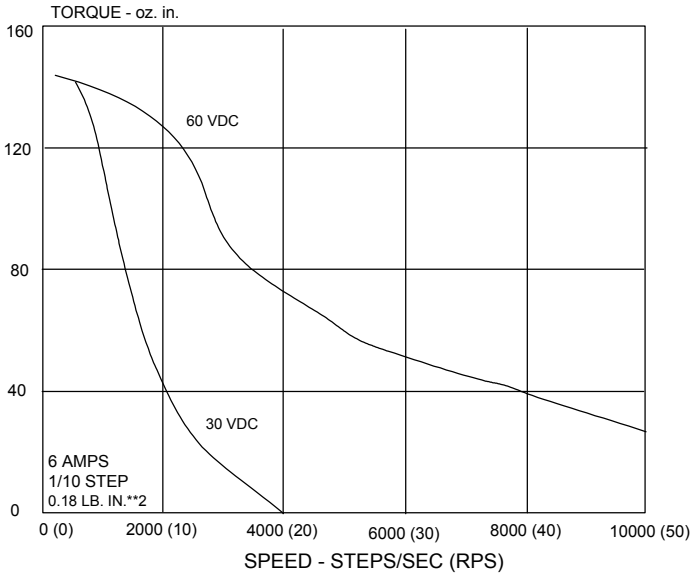

M063-LE09 MOTOR, 6 AMPS PARALLEL CONNECTION

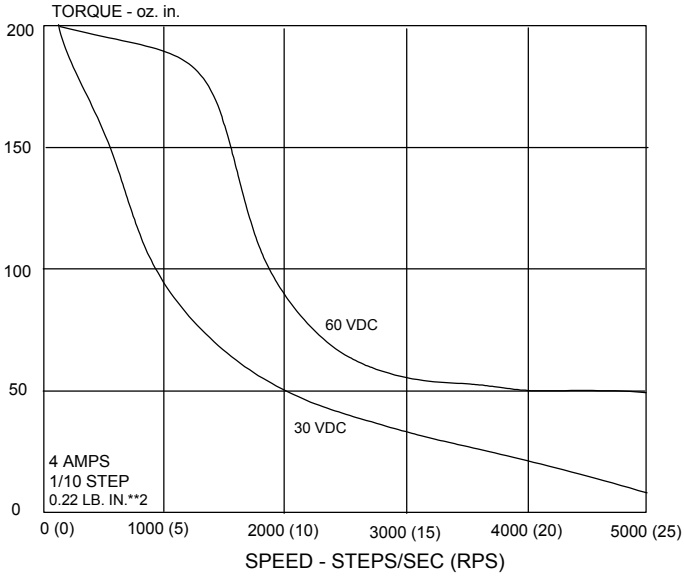

M091-FD8009 or M091-FD8109 MOTOR, 4 AMPS SERIES CONNECTION

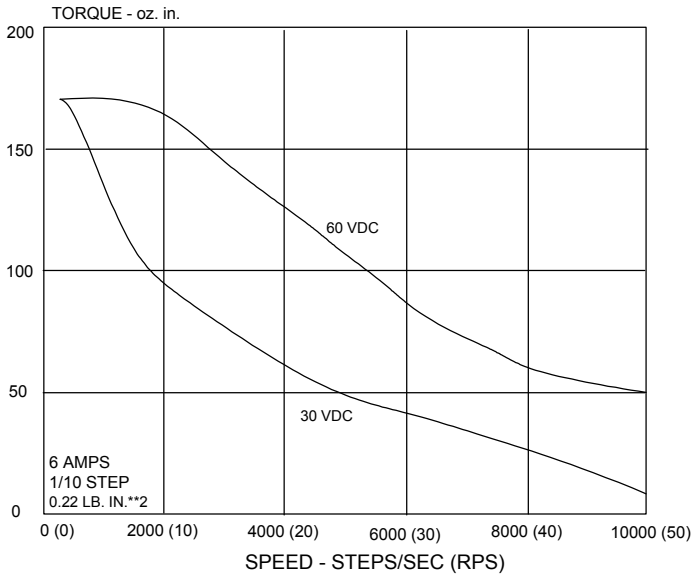

M091-FD8009 or MD091-FD8109 MOTOR, 6 AMPS PARALLEL CONNECTION

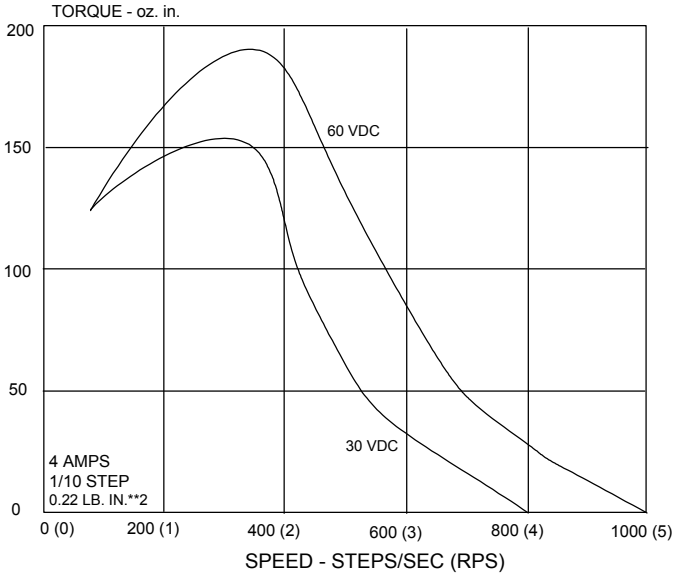

M092-FD8009 or M092-FD8109 MOTOR, 4 AMPS SERIES CONNECTION

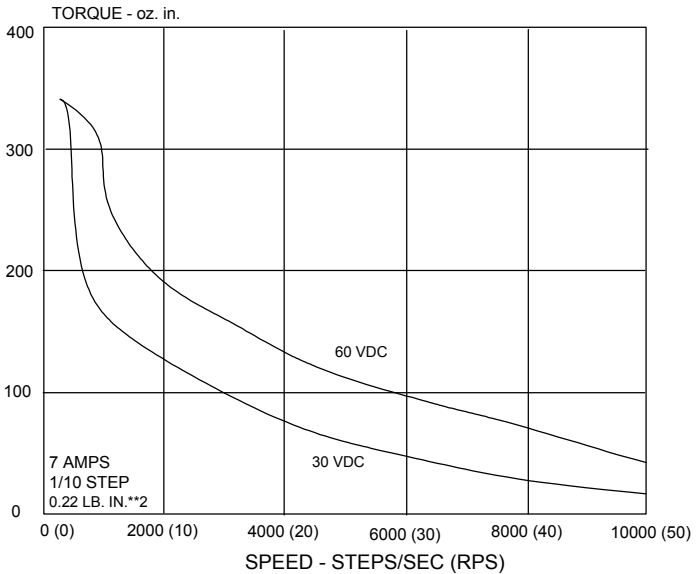

M092-FD8009 or MD092-FD8109 MOTOR, 7 AMPS PARALLEL CONNECTION

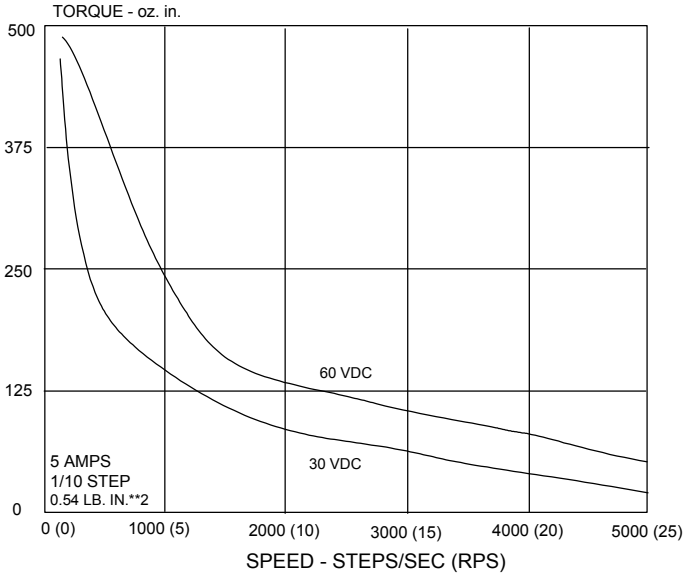

M093-FD8114 or M093-FD8014 MOTOR, 5 AMPS SERIES CONNECTION

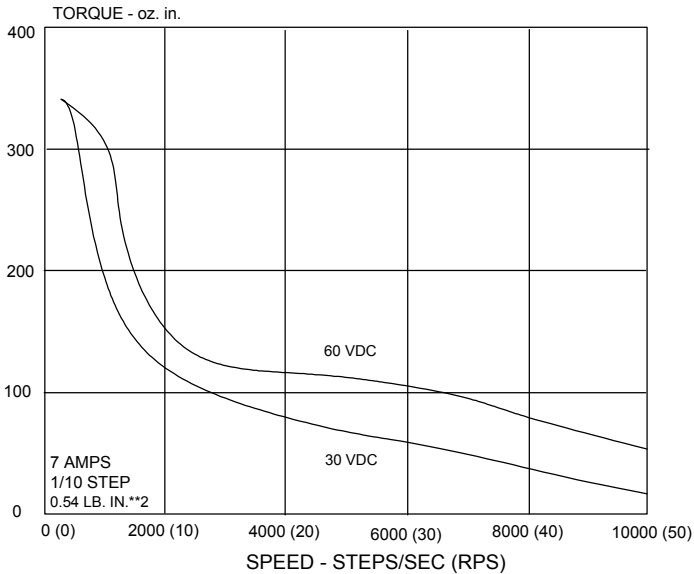

M093-FD8114 or MD093-FD8014 MOTOR, 7 AMPS PARALLEL CONNECTION

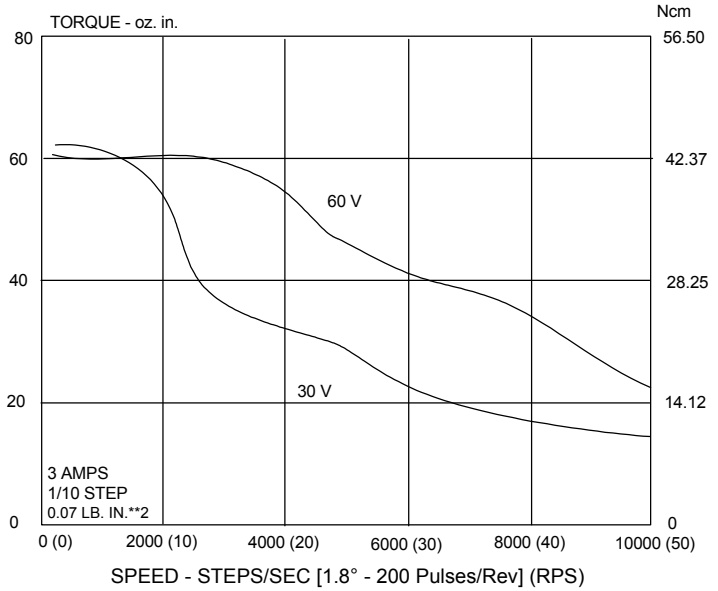

KML060F05 MOTOR, 3 Amp

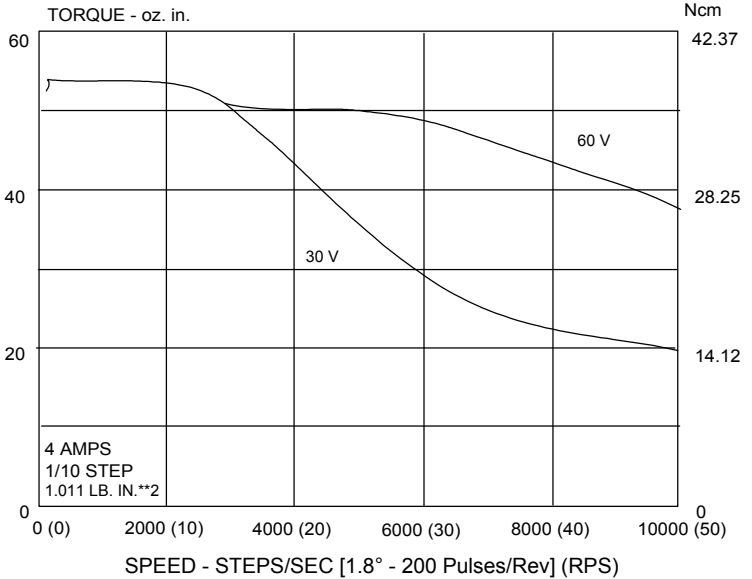

KML060F08 MOTOR, 4 Amp

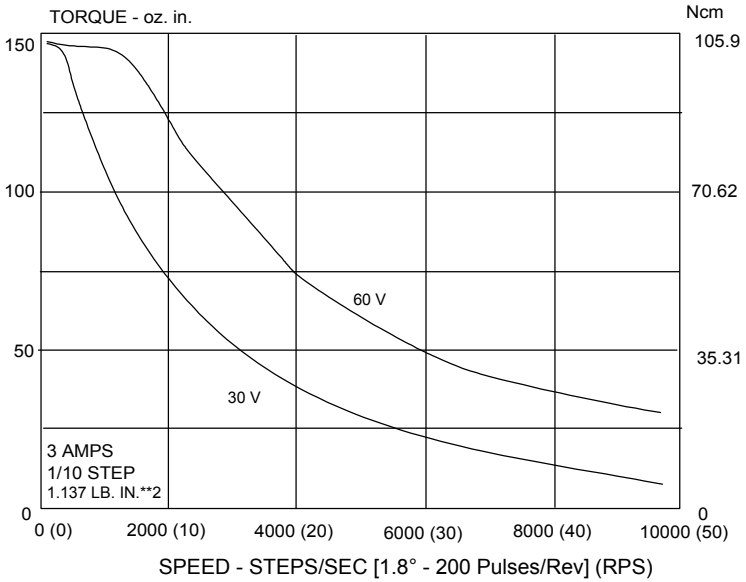

KML061F05 MOTOR, 3 Amp

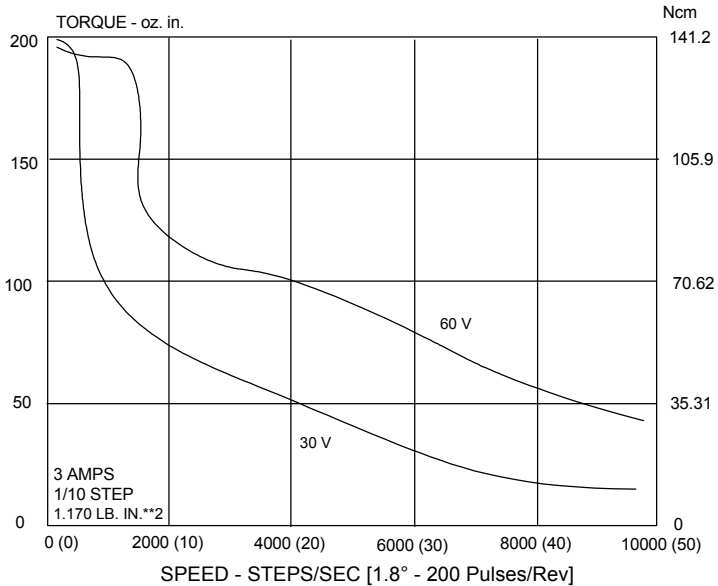

KML062F07 MOTOR, 3 Amp

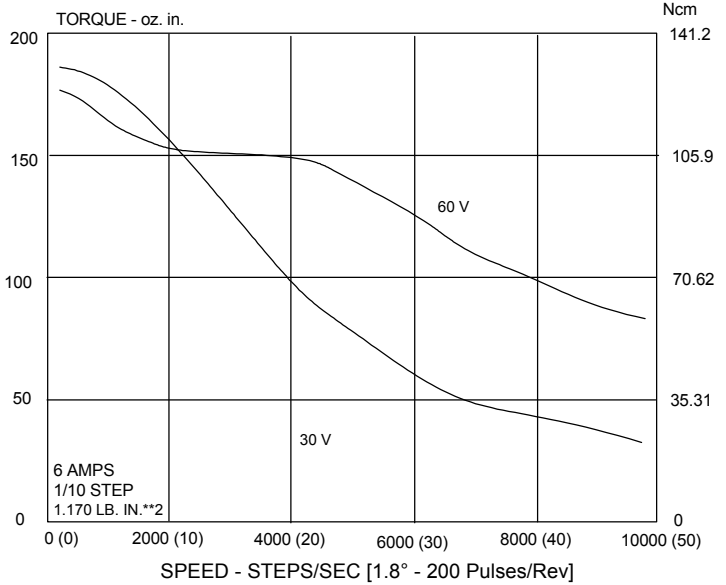

KML062F13 MOTOR, 6 Amp

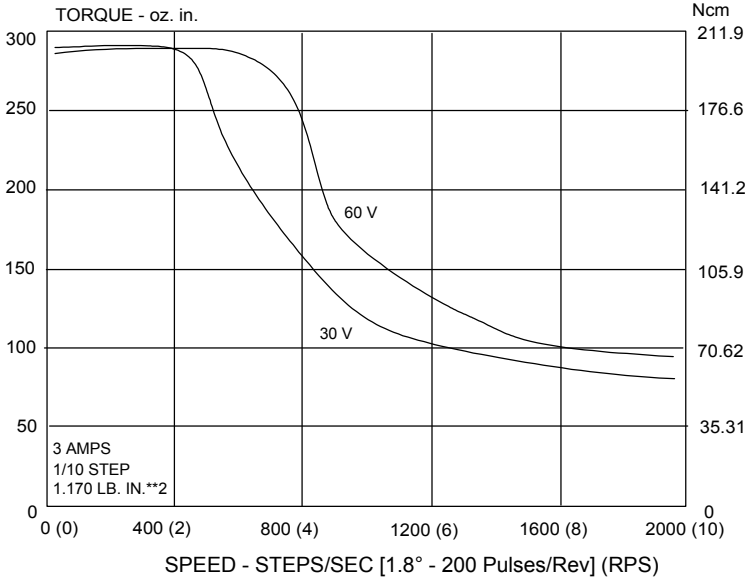

KML063F07 MOTOR, 3 Amp

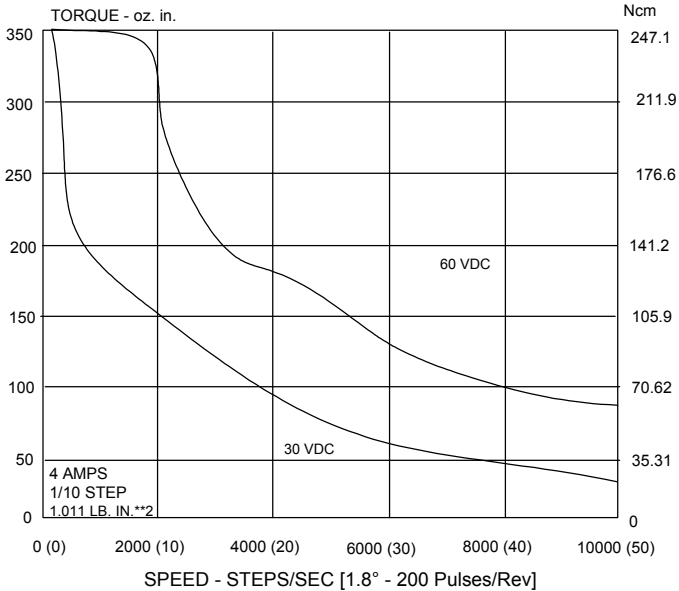
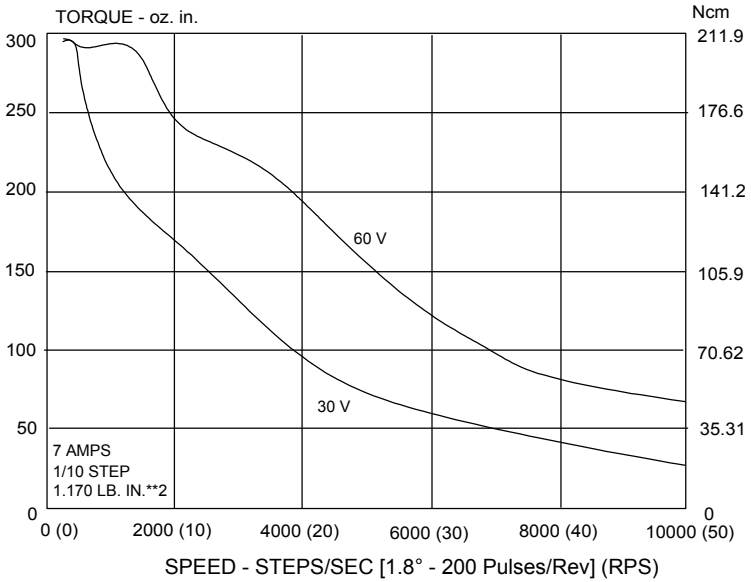

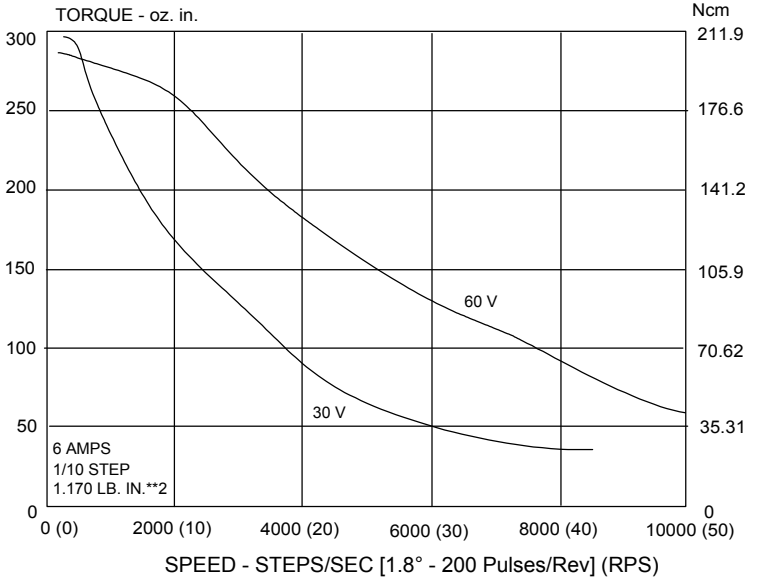

KML091F13 MOTOR, 6 Amp

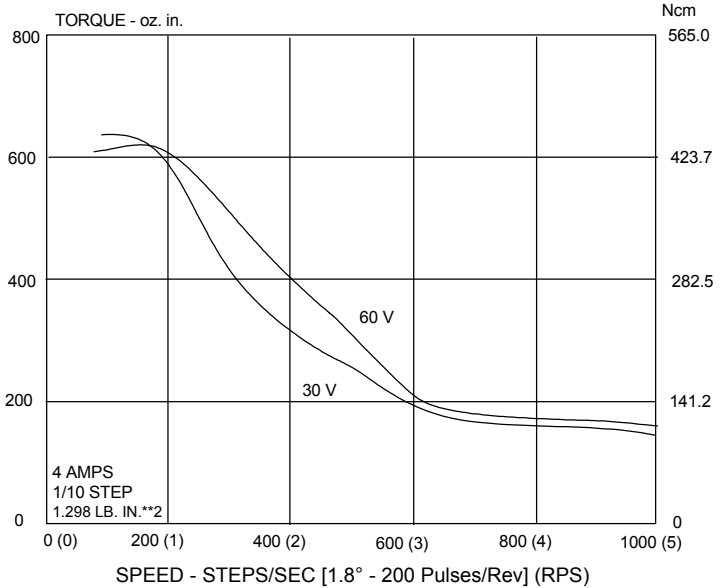

KML092F07 MOTOR, 4 Amp

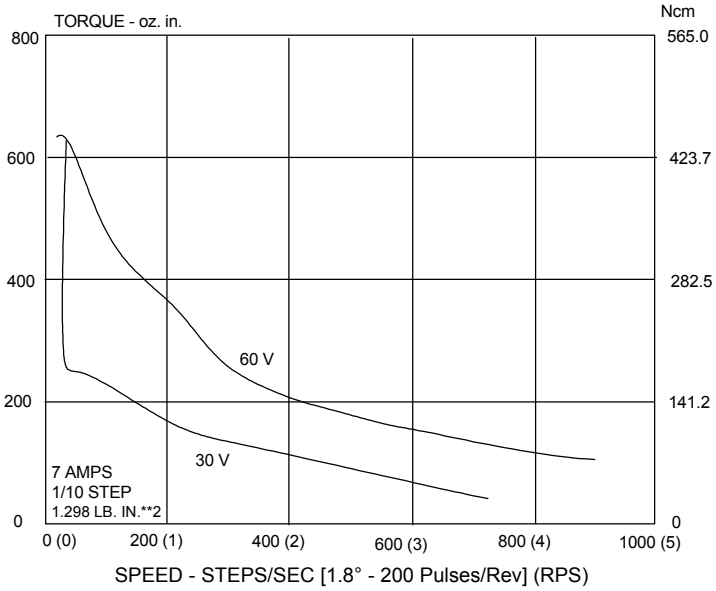

KML092F13 MOTOR, 7 Amp

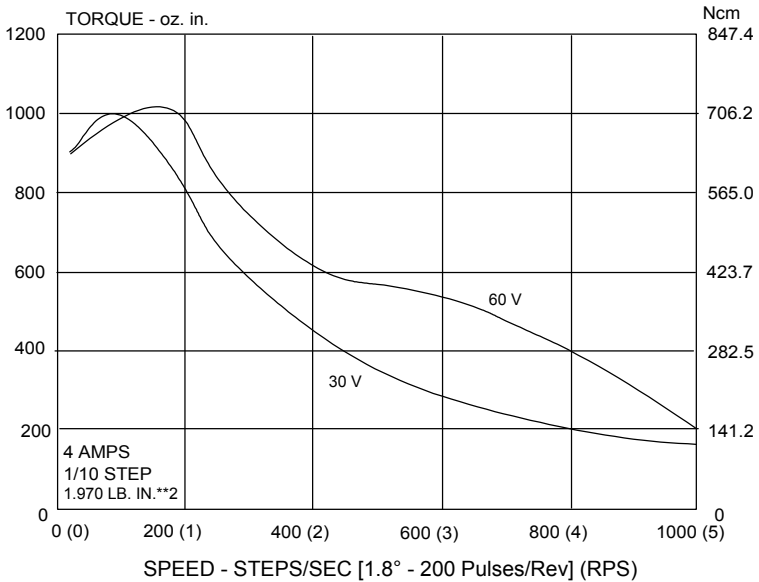

KML093F07 MOTOR, 4 Amp

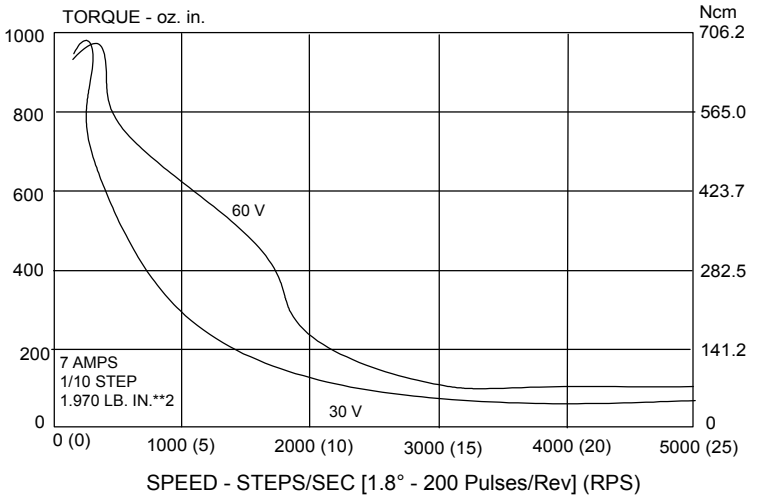

KML093F14 MOTOR, 7 Amp

6. TROUBLESHOOTING



Motors connected to this drive can develop high torque and large amounts of mechanical energy.



Keep clear of the motor shaft and all parts mechanically linked to the motor shaft.



*Turn off all power to the drive **BEFORE** performing work on parts mechanically coupled to the motor.*

If installation and operating instructions have carefully been followed, this unit should perform correctly. If the motor fails to step properly, the following checklist will help locate the correct the problem.

6.1. In General

- Check all installation wiring carefully for wiring errors or poor connections.
- Check to see that the proper voltage levels are being supplied to the unit. Be sure the "POWER ON" LED lights when power is applied.
- Be sure the motor is a correct model for use with this unit.

6.2. Specifically

IF MOTOR DIRECTION (CW, CCW) IS REVERSED, Check For:

Reversed connections to the Motor Connector. Reversing the phase A or the phase B connections reverses the direction of motor rotation.

IF THE MOTOR IS ERRATIC, Check For:

Supply voltage out of tolerance.

Improper motion parameters (low speed, acceleration or deceleration, jog speed, home speed, and feed rate). Set parameters on controller supplying pulse input to drive.

Filter capacitor missing or too low in value.

IF TORQUE IS LOW, Check For:

All Windings Off active or Reduced Current active.

Improper supply voltage.

IF "POWER" INDICATOR IS NOT LIT, Check For:

Improper input wiring and voltage levels.

Blown supply circuit fuse or tripped input circuit breaker.

IF "FAULT" INDICATOR IS LIT, Check For:

Improper motor wiring.

Grounded or shorted wiring to the motor or shorted motor.

Improper motor type or incorrect Current Select switch setting.

Ambient temperature around drive above 50 (122°F).

Heat sink temperature above 70°C (158°F).

Restricted air flow around drive.

If a malfunction occurs that cannot be corrected by making the preceding checks, contact Danaher Motion Customer Support.

APPENDIX A: TROUBLESHOOTING ELECTRICAL INTERFERENCE

Electrical interference problems are common with today's computer-based controls, and such problems are often difficult to diagnose and cure. If such a problem occurs with your system, it is recommended that the following checks be made to locate the cause of the problem.

1. Check the quality of the AC line voltage using an oscilloscope and a line monitor. If line voltage problems exist, use appropriate line conditioning, such as line filters or isolation transformers.
2. Be certain proper wiring practices are followed for location, grounding, wiring, and relay suppression.
3. Double-check the grounding connections to be sure they are good electrical connections and are as short and direct as possible.
4. Try operating the drive with all suspected noise sources switched off. If the drive functions properly, switch the noise sources on again (one at a time) and try to isolate the one(s) causing the interference problems. When a noise source is located, try rerouting wiring, suppressing relays, or other measures to eliminate the problem.

**SAVE THESE
INSTRUCTIONS**

WARRANTY AND LIMITATION OF LIABILITY

Danaher Motion Superior Electric (the "Company") warrants to the first end user purchaser (the "purchaser") of equipment manufactured by the Company that such equipment, if new, unused and in original unopened cartons at the time of purchase, are free from defects in material and workmanship under normal use and service for a period of one year from the date of shipment from the Company's factory or a warehouse of the Company in the event that the equipment is purchased from the Company or for a period of one year from the date of shipment from the business establishment of an authorized distributor of the Company in the event that the equipment is purchased from an authorized distributor.

THE COMPANY'S OBLIGATION UNDER THIS WARRANTY SHALL BE STRICTLY AND EXCLUSIVELY LIMITED TO REPAIRING OR REPLACING, AT THE FACTOR OR A SERVICE CENTER OF THE COMPANY, ANY SUCH EQUIPMENT OR PARTS THEREOF WHICH AN AUTHORIZED REPRESENTATIVE OF THE COMPANY FINDS TO BE DEFECTIVE IN MATERIAL OR WORKMANSHIP UNDER NORMAL USE AND SERVICE WITHIN SUCH PERIOD OF ONE YEAR. THE COMPANY RESERVES THE RIGHT TO SATISFY SUCH OBLIGATION IN FULL BY REFUNDING THE FULL PURCHASE PRICE OF ANY SUCH DEFECTIVE EQUIPMENT. This warranty does not apply to any equipment, which has been tampered with or altered in any way, which has been improperly installed or which has been subject to misuse, neglect, or accident.

THE FOREGOING WARRANTY IS IN LIEU OF ANY OTHER WARRANTIES, EXPRESS OR IMPLIED, INCLUDING, WITHOUT LIMITATION, ANY IMPLIED WARRANTY OF MERCHANTABILITY OR FITNESS FOR A PARTICULAR PURPOSE, and of any other obligations or liabilities on the part of the Company, and no person is authorized to assume for the Company any other liability with respect to equipment manufactured by the Company. The Company shall have no liability with respect to equipment not of its manufacture. THE COMPANY SHALL HAVE NO LIABILITY WHATSOEVER IN ANY EVENT FOR PAYMENT OF ANY INCIDENTAL OR CONSEQUENTIAL DAMAGES, INCLUDING, WITHOUT LIMITATION, DAMAGES FOR INJURY TO ANY PERSON OR PROPERTY.

Written authorization to return any equipment or parts thereof must be obtained from the Company. The Company shall not be responsible for any transportation charges.

IF FOR ANY REASON ANY OF THE FOREGOING PROVISIONS SHALL BE INEFFECTIVE, THE COMPANY'S LIABILITY FOR DAMAGES ARISING OUT OF ITS MANUFACTURE OR SALE OF EQUIPMENT, OR USE THEREOF, WHETHER SUCH LIABILITY IS BASED ON WARRANTY, CONTRACT, NEGLIGENCE, STRICT LIABILITY IN TORT OR OTHERWISE, SHALL NOT IN ANY EVENT EXCEED THE FULL PURCHASE PRICE OF SUCH EQUIPMENT.

Any action against the Company based upon any liability or obligation arising hereunder or under any law applicable to the sale of equipment, or the use thereof, must be commenced within one year after the cause of such action arises.

The right to make engineering refinements on all products is reserved. Dimensions and other details are subject to change.

