



Artisan Technology Group is your source for quality new and certified-used/pre-owned equipment

- FAST SHIPPING AND DELIVERY
- TENS OF THOUSANDS OF IN-STOCK ITEMS
- EQUIPMENT DEMOS
- HUNDREDS OF MANUFACTURERS SUPPORTED
- LEASING/MONTHLY RENTALS
- ITAR CERTIFIED SECURE ASSET SOLUTIONS

SERVICE CENTER REPAIRS

Experienced engineers and technicians on staff at our full-service, in-house repair center

*InstraView*SM REMOTE INSPECTION

Remotely inspect equipment before purchasing with our interactive website at www.instraview.com ↗

WE BUY USED EQUIPMENT

Sell your excess, underutilized, and idle used equipment. We also offer credit for buy-backs and trade-ins. www.artisanng.com/WeBuyEquipment ↗

LOOKING FOR MORE INFORMATION?

Visit us on the web at www.artisanng.com ↗ for more information on price quotations, drivers, technical specifications, manuals, and documentation

Contact us: (888) 88-SOURCE | sales@artisanng.com | www.artisanng.com

VMIPMC-6003 PMC-Based ControlNet Module

Installation Guide



A GE Fanuc Company

12090 South Memorial Parkway
Huntsville, Alabama 35803-3308, USA
(256) 880-0444 ♦ (800) 322-3616 ♦ Fax: (256) 882-0859
522-756003-000 Rev. A



A GE Fanuc Company

12090 South Memorial Parkway
Huntsville, Alabama 35803-3308, USA
(256) 880-0444 ♦ (800) 322-3616 ♦ Fax: (256) 882-0859

COPYRIGHT AND TRADEMARKS

© Copyright 2002. The information in this document has been carefully checked and is believed to be entirely reliable. While all reasonable efforts to ensure accuracy have been taken in the preparation of this manual, VMIC assumes no responsibility resulting from omissions or errors in this manual, or from the use of information contained herein.

VMIC reserves the right to make any changes, without notice, to this or any of VMIC's products to improve reliability, performance, function, or design.

VMIC does not assume any liability arising out of the application or use of any product or circuit described herein; nor does VMIC convey any license under its patent rights or the rights of others.

For warranty and repair policies, refer to VMIC's Standard Conditions of Sale.

AMXbus, BITMODULE, COSMODULE, DMAbus, IOMax, IOWorks Foundation, IOWorks Manager, IOWorks Server, MAGICWARE, MEGAMODULE, PLC ACCELERATOR (ACCELERATION), Quick Link, RTnet, Soft Logic Link, SRTbus, TESTCAL, "The Next Generation PLC", The PLC Connection, TURBOMODULE, UCLIO, UIOD, UPLC, Visual Soft Logic Control(ler), **VMEaccess**, VMEbus Access, **VMEmanager**, **VMEmonitor**, VMEnet, VMEnet II, and **VMEprobe** are trademarks and The I/O Experts, The I/O Systems Experts, The Soft Logic Experts, and The Total Solutions Provider are service marks of VMIC.

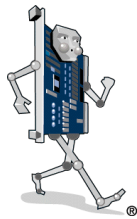

(I/O man figure)



(IOWorks man figure)



The I/O man figure, IOWorks, IOWorks man figure, UIOC, Visual IOWorks and the VMIC logo are registered trademarks of VMIC.

ActiveX, Microsoft, Microsoft Access, MS-DOS, Visual Basic, Visual C++, Win32, Windows, Windows NT, and XENIX are registered trademarks of Microsoft Corporation.

Celeron and MMX are trademarks, and Intel and Pentium are registered trademarks of Intel Corporation.

PICMG and CompactPCI are registered trademarks of PCI Industrial Computer Manufacturers' Group.

Other registered trademarks are the property of their respective owners.

VMIC

All Rights Reserved

This document shall not be duplicated, nor its contents used for any purpose, unless granted express written permission from VMIC.



A GE Fanuc Company

12090 South Memorial Parkway
Huntsville, Alabama 35803-3308, USA
(256) 880-0444 ♦ (800) 322-3616 ♦ Fax: (256) 882-0859

Table of Contents

| | |
|---------------------------------------------------------|----|
| Overview | 7 |
| Functional Description | 8 |
| PCI Local Bus | 8 |
| Embedded Microprocessor | 8 |
| Shared Memory (RAM) | 8 |
| Memory (RAM)..... | 8 |
| Flash ROM | 8 |
| Software Functionality | 8 |
| ControlNet Connectivity | 9 |
| Redundant Media..... | 9 |
| Hardware Design | 9 |
| Media Connection | 9 |
| Environmental Requirements | 10 |
| CE Testing | 10 |
| Certifications | 10 |
| Reference Material List..... | 11 |
| Safety Summary | 12 |
| Ground the System | 12 |
| Do Not Operate in an Explosive Atmosphere | 12 |
| Keep Away from Live Circuits | 12 |
| Do Not Service or Adjust Alone | 12 |
| Do Not Substitute Parts or Modify System | 12 |
| Dangerous Procedure Warnings | 12 |
| Safety Symbols Used in This Manual..... | 13 |
| Chapter 1 - Configuration and Installation | 15 |
| Unpacking Procedures | 16 |
| System Requirements | 16 |

| | |
|-----------------------------------------------------------|-----------|
| Physical Installation | 17 |
| ControlNet Module Device Driver Installation | 18 |
| Front Bezel Status LEDs | 19 |
| ControlNet Status LED Interpretation | 19 |
| ControlNet Status LED Definitions | 20 |
| Connecting the ControlNet Module to the Network | 22 |
| Maintenance | 23 |
| Maintenance | 23 |
| Maintenance Prints | 24 |

Overview

Contents

| | |
|------------------------------------------|----|
| Functional Description | 8 |
| Reference Material List | 11 |
| Safety Summary | 12 |
| Safety Symbols Used in This Manual | 13 |

Introduction

The VMIPMC-6003 is a PMC-based ControlNet Module. The module permits a host Single Board Computer (SBC) with an available PCI Mezzanine Card (PMC) slot to communicate over the ControlNet network. The VMIPMC-6003 emulates Rockwell Automation's 1784-PCICS ControlNet Module and is designed to be fully compatible with Rockwell Automation's SoftLogix 5800 software running under Windows NT.

The VMIPMC-6003 has two BNC connectors located on the front bezel supporting redundant media.

The VMIPMC-6003 PMC-Based ControlNet Module has several useful features:

- On-board high-speed processor (NS486SXF)
- 32-bit/33 MHz, 5 V signaling
- 2 Mbyte Memory (DRAM)
- 512 Kbyte Flash ROM
- Transfer rate of 5 Mbit/s
- Scan ControlNet I/O under SoftLogix
- ControlNet Connectivity for RSLinx and RSNetWorx
- PCI revision 2.2 compliant

Functional Description

The VMIPMC-6003 is a 32-bit, 33 MHz PMC ControlNet Module. The ControlNet Module is capable of scanning I/O using the Rockwell Automation SoftLogix 5800 software. The ControlNet Module will appear to the SoftLogix as a Rockwell Automation 1784-PCICS PCI ControlNet Module.

PCI Local Bus

The VMIPMC-6003 is based on the PCI Local Bus Specification Rev. 2.2.

Embedded Microprocessor

An NS486SXF Microprocessor is used as the Embedded Microprocessor for the module. The Embedded Microprocessor's firmware manages data transfers across the ControlNet network and the Shared Memory.

The Embedded Microprocessor is also responsible for maintaining the network. It manages and organizes the I/O devices, and performs I/O scans.

Shared Memory (RAM)

Shared Memory (RAM) provides the data interface between the Embedded Microprocessor and the PCI Local bus. PCI Local bus accesses to the Shared Memory are controlled by handshaking signals provided by the PCI interface chip. Embedded Microprocessor accesses to the Shared Memory are controlled by logic in a Programmable Logic Device on the module.

Simultaneous access to the Shared Memory is controlled internally by the Shared Memory. Either the PCI interface chip or the Embedded Microprocessor is placed in wait states until the contention is removed.

Memory (RAM)

The VMIPMC-6003 has 2 Mbytes of Dynamic RAM (DRAM) for use as program memory by the Embedded Microprocessor.

Flash ROM

The VMIPMC-6003 has 512 Kbyte of Flash ROM for storing the firmware. This Flash Memory device also may contain non-volatile information required for use by the network. The Flash ROM is re-programmable so that firmware updates are possible.

Software Functionality

The VMIPMC-6003 provides the hardware interface for SoftLogix to scan ControlNet I/O. Since the ControlNet Module emulates the 1784-PCICS, software functionality is provided by the drivers for the 1784-PCICS; no other special software is required. The VMIPMC-6003 contains embedded firmware that allows the module to manage the ControlNet network and transfer data across the Shared Memory to the PCI bus. The ControlNet Module does not perform I/O logic, and therefore is not programmable. The supported operating system platform is Windows NT.

ControlNet Connectivity

The VMIPMC-6003 has two BNC connectors located on the front bezel, labeled Port A and Port B. This allows the VMIPMC-6003 to support Redundant Media. The two BNC connectors provide connectivity to a ControlNet network. ControlNet Port A provides the primary connection to the network. ControlNet Port B provides support for redundant media. If redundant media is not used, the network should be connected to ControlNet Port A only. ControlNet Port B is left unconnected.

Redundant Media

The ControlNet network provides the option of installing a second cable between nodes. With redundant media, nodes send identical signals on two separate segments. The receiving node continuously compares the signals quality and selects the better cable in case one is improperly installed, not connected or fails.

Hardware Design

The VMIPMC-6003 form factor is a single-size CMC card. Its construction conforms to the CMC and PMC standard specification in appearance, size and material. The P1 and P2 connectors are populated on the module, while the P3 and P4 connectors are not populated. The module is keyed for 5 V PCI bus signaling only. Figure 1 below is the functional block diagram.

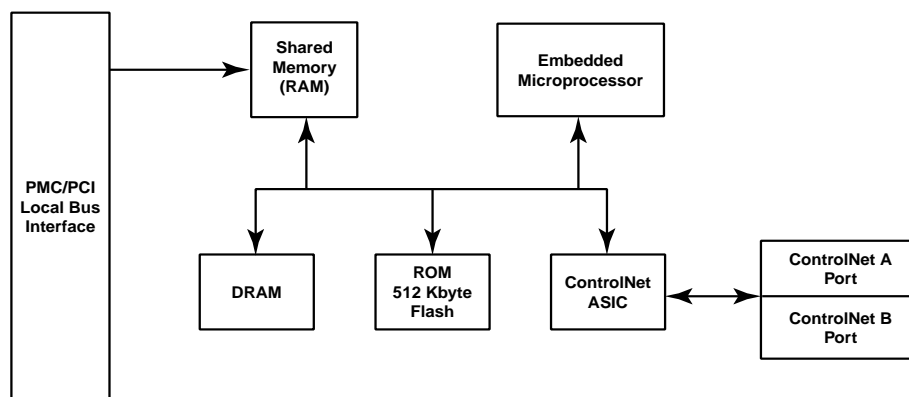

Figure 1 VMIPMC-6003 Functional Block Diagram

Media Connection

The VMIPMC-6003 uses a Quad-shield RG-6 Coaxial cable and Tap. This is the main system trunk cable. The Tap is used for connection to the network using the Coaxial cables. VMIC does not supply the cable or Tap. The cable and Tap are available from the following source:

| | |
|--------------------------------------------------------------------------------------------------------------------------------------------------------------------------------------------------------------------------------|------------------------------------------------------------------------------------------------------------------------------------------------------------------------------------------------|
| Rockwell Automation 1201 South Second ST. Milwaukee, WI 53204-2496, USA (414) 382-2000 FAX: (414) 382-4444 www.ab.com/catalogs/b113/comm/cnet.html | Allen-Bradley ControlNet Network, ControlNet Media Quad-Shield RG-6 Coaxial Cable: Part Number: 1786-RG6 ControlNet Tap: Part Number: 1786-TPR, -TPS, -TPYR or -TPYS |
|--------------------------------------------------------------------------------------------------------------------------------------------------------------------------------------------------------------------------------|------------------------------------------------------------------------------------------------------------------------------------------------------------------------------------------------|

Environmental Requirements

The VMIPMC-6003 is designed to operate in an industrial environment where there is little control over the ambient conditions. The product is expected to operate in a temperate range from 0° C to 60° C.

CE Testing

The VMIPMC-6003 is designed to meet the following CE specifications:

- Conducted Immunity EN 61000-4-6
- Conducted Emissions EN 55011
- Radiated Emissions EN 55011
- Radiated Immunity EN 61000-4-3
- Electrical Fast Transient/Burst EN 61000-4-4
- ESD EN 61000-4-2
- Surge Immunity EN 61000-4-5

Certifications

The VMIPMC-6003 is designed to meet the following certifications:

- Recognized by Underwriters Laboratories per UL508 and cUL Hazardous Locations, Class 1, Div. 2, Groups A, B, C and D.
- Compliant with EU96 Low Voltage directives - Safety Requirements EN61131-2 Programmable Controllers, Part 2.

Reference Material List

Refer to the *PCI Local bus Rev. 2.2 Specification*, available from the following source:

PCI Special Interest Group
P.O. Box 14070
Portland, OR 97214
U.S.: (800) 433-5177
International: (503) 797-4207
FAX: (503) 234-6762

For a detailed explanation of the Common Mezzanine Card Family and its characteristics, refer to the *CMC Specification, P1386/Draft 2.0* from:

IEEE Standards Department
Copyrights and Permissions
445 Hoes Lanes, P.O. Box 1331
Piscataway, NJ 08855-1331, USA

For a detailed explanation of the Physical and Environmental Layers for PCI Mezzanine Cards, refer to the *PMC Specification, P1386.1/Draft 2.0* from:

IEEE Standards Department
Copyrights and Permissions
445 Hoes Lanes, P.O. Box 1331
Piscataway, NJ 08855-1331, USA

Refer to the ControlNet Specification for a detailed explanation of the ControlNet Network. The *ControlNet Specification* is available from the following source:

ControlNet International, Ltd.
20423 State Road 7 · Suit 315
Boca Raton, FL 33498, USA
(561) 477-7966
FAX: (561) 477-6621
E-Mail: controlnet@powerinternet.com
www.controlnet.org

Refer to Rockwell Automation for a detailed explanation of the *1784-PCICS ControlNet Module, RSLinx, RSNetworx for ControlNet and the SoftLogix 5800 software* available from the following source:

Rockwell Automation
1201 South Second ST,
Milwaukee, WI 53204-2496, USA
(414) 382-2000
FAX: (414) 382-4444
E-Mail: racie3net@ra.rockwell.com

Refer to Product Specification 800-756003-000 available from:

VMIC
12090 South Memorial Pkwy.
Huntsville, AL 35803-3308, USA
(256) 880-0444 · Toll Free: (800) 322-3616
FAX: (256) 882-0859
www.vmic.com

Safety Summary

The following general safety precautions must be observed during all phases of the operation, service and repair of this product. Failure to comply with these precautions or with specific warnings elsewhere in this manual violates safety standards of design, manufacture and intended use of this product.

VMIC assumes no liability for the customer's failure to comply with these requirements.

Ground the System

To minimize shock hazard, the chassis and system cabinet must be connected to an electrical ground. A three-conductor AC power cable should be used. The power cable must either be plugged into an approved three-contact electrical outlet or used with a three-contact to two-contact adapter with the grounding wire (green) firmly connected to an electrical ground (safety ground) at the power outlet.

Do Not Operate in an Explosive Atmosphere

Do not operate the system in the presence of flammable gases or fumes. Operation of any electrical system in such an environment constitutes a definite safety hazard.

Keep Away from Live Circuits

Operating personnel must not remove product covers. Component replacement and internal adjustments must be made by qualified maintenance personnel. Do not replace components with power cable connected. Under certain conditions, dangerous voltages may exist even with the power cable removed. To avoid injuries, always disconnect power and discharge circuits before touching them.

Do Not Service or Adjust Alone

Do not attempt internal service or adjustment unless another person, capable of rendering first aid and resuscitation, is present.

Do Not Substitute Parts or Modify System









Because of the danger of introducing additional hazards, do not install substitute parts or perform any unauthorized modification to the product. Return the product to VMIC for service and repair to ensure that safety features are maintained.

Dangerous Procedure Warnings

Warnings, such as the example below, precede only potentially dangerous procedures throughout this manual. Instructions contained in the warnings must be followed.

STOP: Dangerous voltages, capable of causing death, are present in this system. Use extreme caution when handling, testing and adjusting.

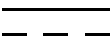
Safety Symbols Used in This Manual

| | |
|------------------------------------------------------------------------------------------------------------------------------------------------------------------------|----------------------------------------------------------------------------------------------------------------------------------------------------------------------------------------------------------------------------------------------------------------------------------------------------------------------------|
|  | Indicates dangerous voltage (terminals fed from the interior by voltage exceeding 1000 V are so marked). |
|  OR  | Protective conductor terminal. For protection against electrical shock in case of a fault. Used with field wiring terminals to indicate the terminal which must be connected to ground before operating equipment. |
|  | Low-noise or noiseless, clean ground (earth) terminal. Used for a signal common, as well as providing protection against electrical shock in case of a fault. Before operating the equipment, terminal marked with this symbol must be connected to ground in the manner described in the installation (operation) manual. |
|  OR  | Frame or chassis terminal. A connection to the frame (chassis) of the equipment which normally includes all exposed metal structures. |
|  | Alternating current (power line). |
|  | Direct current (power line). |
|  | Alternating or direct current (power line). |

STOP: This symbol informs the operator that a practice or procedure should not be performed. Actions could result in injury or death to personnel, or could result in damage to or destruction of part or all of the system.

WARNING: This sign denotes a hazard. It calls attention to a procedure, a practice or a condition, which, if not correctly performed or adhered to, could result in injury or death to personnel.

CAUTION: This sign denotes a hazard. It calls attention to an operating procedure, a practice or a condition, which, if not correctly performed or adhered to, could result in damage to or destruction of part or all of the system.

NOTE: Calls attention to a procedure, a practice, a condition or the like, which is essential to highlight.

Configuration and Installation

Contents

| | |
|-------------------------------------------------------|----|
| Unpacking Procedures | 16 |
| Physical Installation..... | 17 |
| Front Bezel Status LEDs | 19 |
| Connecting the ControlNet Module to the Network | 22 |

Introduction

This chapter describes the installation of the board. Cable configuration and board layout are illustrated in this chapter also.

Unpacking Procedures

CAUTION: Some of the components assembled on VMIC's products may be sensitive to electrostatic discharge and damage may occur on boards that are subjected to a high-energy electrostatic field. When the board is placed on a bench for configuring, etc., it is suggested that conductive material should be inserted under the board to provide a conductive shunt. Unused boards should be stored in the same protective boxes in which they were shipped.

Upon receipt, any precautions found in the shipping container should be observed. All items should be carefully unpacked and thoroughly inspected for damage that might have occurred during shipment. The board(s) should be checked for broken components, damaged printed circuit board(s), heat damage, and other visible contamination. All claims arising from shipping damage should be filed with the carrier and a complete report sent to VMIC together with a request for advice concerning the disposition of the damaged item(s).

System Requirements

Before installing the VMIPMC-6003 ControlNet Module, check your system for the following required or minimum configuration requirements:

- One open 32-bit bus master PMC site
- 64 Mbyte of system memory
- The latest system BIOS installed on the motherboard
- Operating system; Microsoft Windows NT 4.0, service pack 3 or service pack 4 is required

Physical Installation

CAUTION: Do not install or remove the board while power is applied.

Host systems containing PMC card sites vary widely in appearance and board installation procedures. VMIC recommends examining the host system installation procedures prior to installing this board.

1. Remove the PMC slot cover bracket where the board is to be installed per the host unit hardware documentation.
2. Insert this board firmly onto the PMC connectors (see Figure 1-1 for installation of the VMIPMC-6003.)
3. Secure the VMIPMC-6003 board to the PMC connectors using the four screws provided.

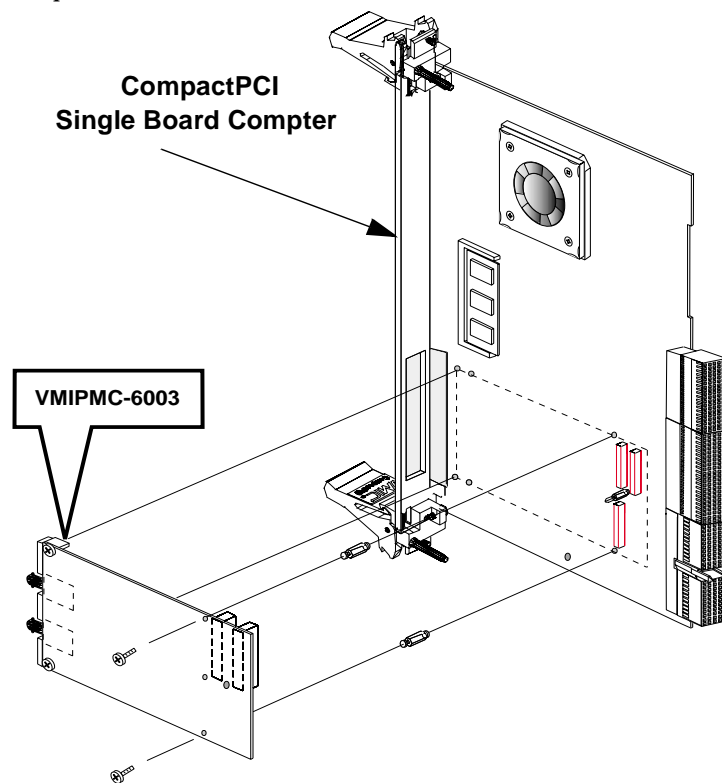

NOTE: The VMIPMC-6003 is designed to interface with any suitable PMC compliant baseboard using a direct PCI bus interface compliant with v2.2 of the PCI signalling specification as defined by IEEE P1386.1 Draft 2.0.

Figure 1-1 Installing the VMIPMC-6003

4. Slide the SBC into the chassis, firmly seating the board onto the backplane connectors. Secure the SBC to the chassis using the screws in the front panel.
5. Turn the power on. The computer's PCI BIOS automatically assigns resources to the adapter. If you get a PCI configuration error, see *PCI Configuration Troubleshooting* in the SBC's documentation.

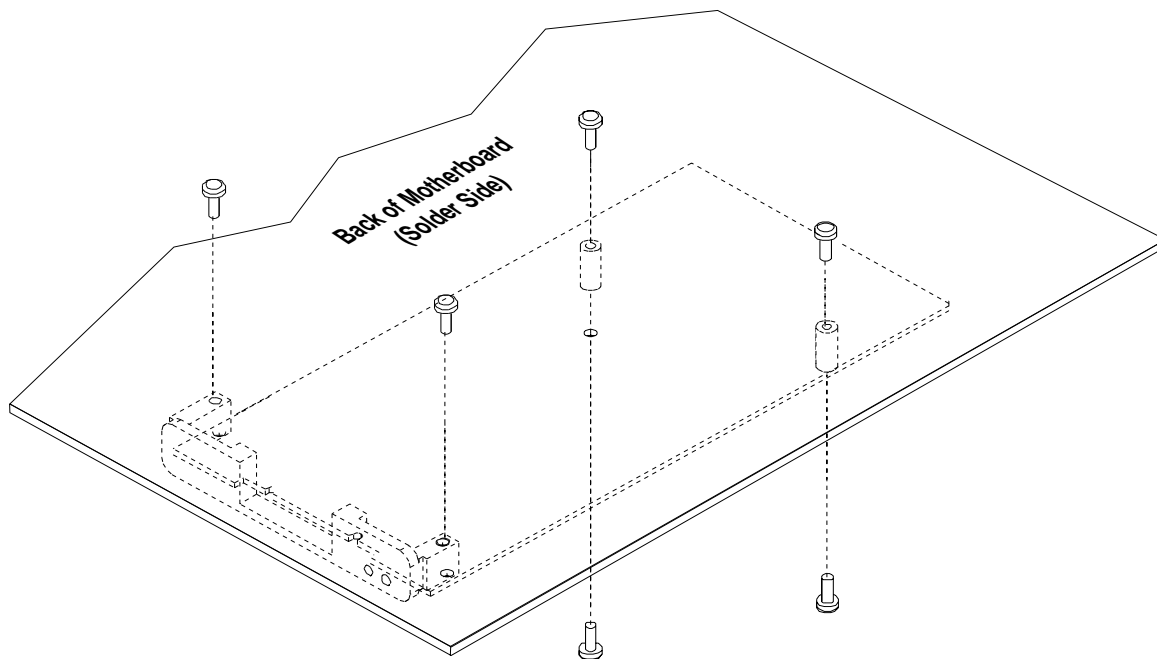

NOTE: All mounting screws are supplied by VMIC.

Figure 1-2 Location of Mounting Screws (Motherboard Solder Side)

ControlNet Module Device Driver Installation

The following releases of Rockwell Software RSLinx include the device drivers for the VMIPMC-6003, which emulates the 1784-PCIC card:

- RSLinx 2.1 Service Pack 2 and later
- RSLinx 2.2 and later

Refer to the online Help in RSLinx for information on how to configure the driver for the VMIPMC-6003 (1784-PCIC). For more information about RSLinx, visit:

www.software.rockwell.com

Front Bezel Status LEDs

The VMIPMC-6003 has two status LEDs located on the front bezel. The status LEDs are used to give a visual status of the VMIPMC-6003 during normal operations (see Figure 1-3 on page 21 for an illustration of the front bezel). See Table 1-1 below and Table 1-2 on page 20 for more information.

ControlNet Status LED Interpretation

- **Steady** - LED is on continuously in the defined state.
- **Alternating** - The two LEDs alternate between the two defined states at the same time (applies to both LEDs viewed together). The two LEDs are always in opposite states, out of phase.
- **Flashing** - The LEDs alternate between the two defined states (applies to each LED viewed independent of the other). If both LEDs flash, they must flash together, in phase.

Table 1-1 Front Panel Status LEDs

| LED Color | Description |
|------------------------------|--------------------------------------------------------------------|
| OFF | No power Driver not started Card faulted Channel disabled |
| Steady Red | Faulted card |
| Alternating Red/Green | Self-Test |
| Alternating Red/Off | Incorrect node configuration Duplicate node address |
| Steady Green | Normal operation |
| Flashing Green/Off | Temporary network errors |
| Flashing Red/Off | Media fault No other nodes present on network |
| Flashing Red/Green | Incorrect node address Incorrect network configuration |

ControlNet Status LED Definitions

Table 1-2 LED Error Definitions

| Port A or Port B | Cause | Action |
|-----------------------|---------------------------------------------------------------------------------------------------------------------------|-----------------------------------------------------------------------------------------------------------------------------------------------------------------------------------------------------------------------------------------------------------------------------------------------------------------------------------------------------------------------------|
| Off | No Power | None or apply power to the SBC |
| | PCICS driver not started | <ul style="list-style-type: none"> Start RSLinx Verify that the PCICS driver has been configured properly in RSLinx |
| | Faulted card | <ul style="list-style-type: none"> Check operating system event log for details of fault (if the operating system supports an event log) Cycle power to the SBC Verify that you have firmly mated the ControlNet Module to the motherboard PMC site and all screws are tightened If fault persists, contact VMIC Customer Service |
| Steady Red | Faulted card | <ul style="list-style-type: none"> Cycle power to the SBC Verify that you have firmly mated the ControlNet Module to the motherboard PMC site and all screws are tightened If fault persists, contact VMIC Customer Service |
| Alternating Red/Green | Self-Test | None |
| Alternating Red/Off | <ul style="list-style-type: none"> Incorrect node configuration Duplicate ControlNet node address | <ul style="list-style-type: none"> Check ControlNet Module node address and other ControlNet configuration parameters |
| OFF | Channel disabled | <ul style="list-style-type: none"> Program network for redundant media, if required |
| Steady Green | Normal Operation | None |
| Flashing Green/Off | Temporary network errors | <ul style="list-style-type: none"> Check media for broken cables, loose connectors, missing terminators, etc. If condition persists, refer to the ControlNet Planning and Installation Manual, publication 1786-6.2-1 |
| Flashing Red/Off | Media Fault | <ul style="list-style-type: none"> Check media for broken cables, loose connectors, missing terminators, etc. If condition persists, refer to the ControlNet Planning and Installation Manual, publication 1786-6.2-1 |
| | No other nodes present on network | <ul style="list-style-type: none"> Add other nodes to the network |
| Flashing Red/Green | Incorrect node address | <ul style="list-style-type: none"> Change ControlNet Module node address so that it is less than or equal to UMAX (see note) Stop and restart the ControlNet Module driver in RSLinx |
| | Incorrect Network configuration | <ul style="list-style-type: none"> Reconfigure the ControlNet network so that UMAX (see note) is greater than or equal to the ControlNet Module node address |

NOTE: UMAX is the highest node address on a ControlNet network that can transmit data.

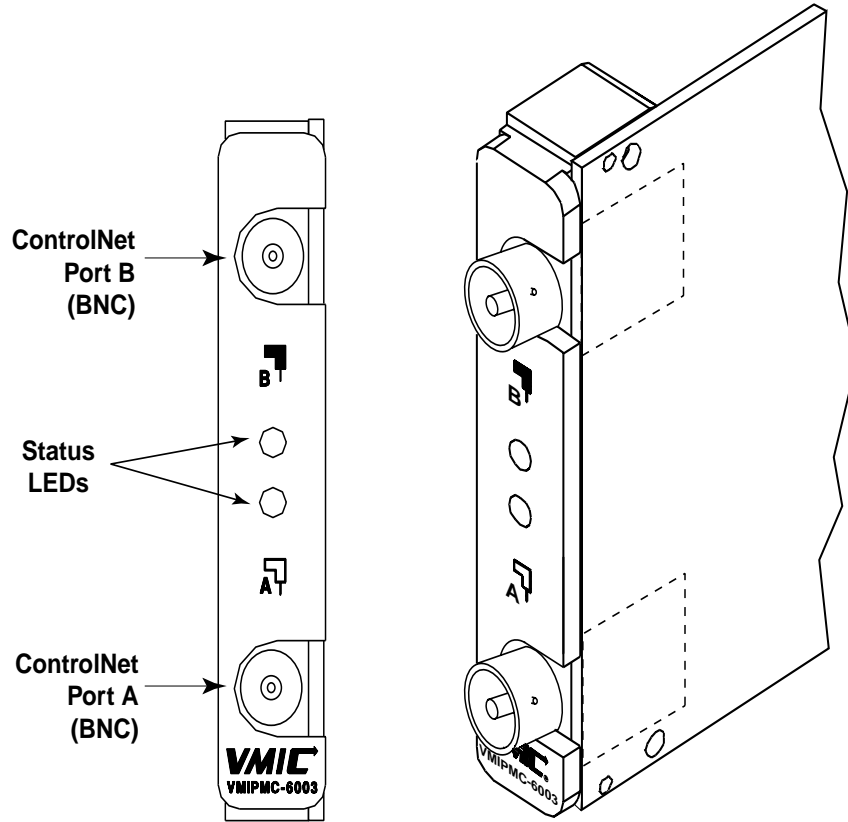



Figure 1-3 VMIPMC-6003 Front Bezel

NOTE: Actual ControlNet products are labeled with these icons.  

Connecting the ControlNet Module to the Network

Figure 1-4 below illustrates how to connect the ControlNet Module directly to the ControlNet network, using Quad-Shield RG-6 coaxial cable and the ControlNet Tap.

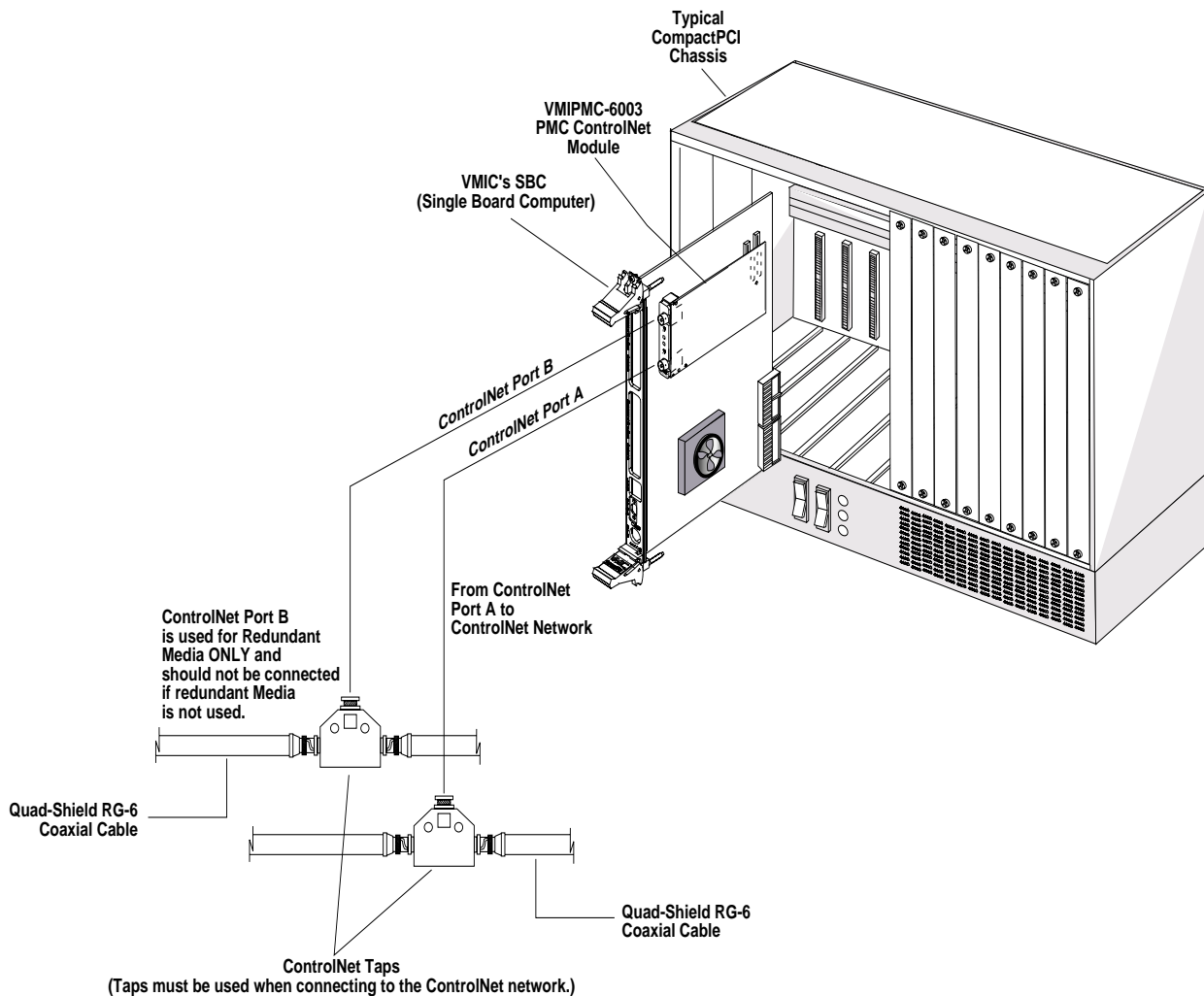

Figure 1-4 Connecting the VMIPMC-6003 to the ControlNet Network

NOTE: When connecting the VMIPMC-6003 to the ControlNet network, the ControlNet Tap must be used to interconnect the cables.

Maintenance

Maintenance

This section provides information relative to the care and maintenance of VMIC's products. If the product malfunctions, verify the following:

- Software
- System configuration
- Electrical connections
- Jumper or configuration options
- Boards are fully inserted into their proper connector location
- Connector pins are clean and free from contamination
- No components of adjacent boards are disturbed when inserting or removing the board from the chassis
- Quality of cables and I/O connections

If the product must be returned, contact VMIC for a Return Material Authorization (RMA) Number. **This RMA Number must be obtained prior to any return.**

Contact VMIC customer Service at 1-800-240-7782, or
E-mail: customer.service@vmic.com .

Maintenance Prints

User level repairs are not recommended. The drawings and tables in this manual are for reference purposes only.



Artisan Technology Group is your source for quality new and certified-used/pre-owned equipment

- FAST SHIPPING AND DELIVERY
- TENS OF THOUSANDS OF IN-STOCK ITEMS
- EQUIPMENT DEMOS
- HUNDREDS OF MANUFACTURERS SUPPORTED
- LEASING/MONTHLY RENTALS
- ITAR CERTIFIED SECURE ASSET SOLUTIONS

SERVICE CENTER REPAIRS

Experienced engineers and technicians on staff at our full-service, in-house repair center

*InstraView*SM REMOTE INSPECTION

Remotely inspect equipment before purchasing with our interactive website at www.instraview.com ↗

WE BUY USED EQUIPMENT

Sell your excess, underutilized, and idle used equipment. We also offer credit for buy-backs and trade-ins. www.artisanng.com/WeBuyEquipment ↗

LOOKING FOR MORE INFORMATION?

Visit us on the web at www.artisanng.com ↗ for more information on price quotations, drivers, technical specifications, manuals, and documentation

Contact us: (888) 88-SOURCE | sales@artisanng.com | www.artisanng.com