



Artisan Technology Group is your source for quality new and certified-used/pre-owned equipment

- FAST SHIPPING AND DELIVERY
- TENS OF THOUSANDS OF IN-STOCK ITEMS
- EQUIPMENT DEMOS
- HUNDREDS OF MANUFACTURERS SUPPORTED
- LEASING/MONTHLY RENTALS
- ITAR CERTIFIED SECURE ASSET SOLUTIONS

SERVICE CENTER REPAIRS

Experienced engineers and technicians on staff at our full-service, in-house repair center

*InstraView*SM REMOTE INSPECTION

Remotely inspect equipment before purchasing with our interactive website at www.instraview.com ↗

WE BUY USED EQUIPMENT

Sell your excess, underutilized, and idle used equipment. We also offer credit for buy-backs and trade-ins. www.artisanng.com/WeBuyEquipment ↗

LOOKING FOR MORE INFORMATION?

Visit us on the web at www.artisanng.com ↗ for more information on price quotations, drivers, technical specifications, manuals, and documentation

Contact us: (888) 88-SOURCE | sales@artisanng.com | www.artisanng.com



Universal I/O Chassis

(Cat. No. 1771-A1B, -A2B, -A3B, -A3B1, -A4B Series B)

To the Installer

To install an I/O chassis you	See page
important user information	1
prepare for installation	4
allow sufficient mounting space	4
mount the I/O chassis and ground bus	8
ground the chassis	9
set the power supply configuration jumper	13
set the switches on the backplane assembly	13
provide power to the I/O chassis	14
install I/O modules	16
hazardous location approval	18
specifications	19

Important User Information

Because of the variety of uses for the products described in this publication, those responsible for the application and use of these products must satisfy themselves that all necessary steps have been taken to assure that each application and use meets all performance and safety requirements, including any applicable laws, regulations, codes and standards. In no event will Allen–Bradley be responsible or liable for indirect or consequential damage resulting from the use or application of these products.

Any illustrations, charts, sample programs, and layout examples shown in this publication are intended solely for purposes of example. Since there are many variables and requirements associated with any particular installation, Allen–Bradley does not assume responsibility or liability (to include intellectual property liability) for actual use based upon the examples shown in this publication.

Allen–Bradley publication SGI–1.1, Safety Guidelines for Application, Installation, and Maintenance of Solid–State Control (available from your local Allen–Bradley office), describes some important differences between solid–state equipment and electromechanical devices that should be taken into consideration when applying products such as those described in this publication.

Reproduction of the contents of this copyrighted publication, in whole or part, without written permission of Rockwell Automation, is prohibited.

Throughout this publication, notes may be used to make you aware of safety considerations. The following annotations and their accompanying statements help you to identify a potential hazard, avoid a potential hazard, and recognize the consequences of a potential hazard.

WARNING

Identifies information about practices or circumstances that can cause an explosion in a hazardous environment, which may lead to personal injury or death, property damage, or economic loss.

ATTENTION

Identifies information about practices or circumstances that may lead to personal injury or death, property damage, or economic loss.

IMPORTANT

Identifies information that is critical for successful application and understanding of the product.

ATTENTION**Environment and Enclosure**

This equipment is intended for use in a Pollution Degree 2 industrial environment, in overvoltage Category II applications (as defined in IEC publication 60664–1), at altitudes up to 2000 meters without derating.

This equipment is considered Group 1, Class A industrial equipment according to IEC/CISPR Publication 11. Without appropriate precautions, there may be potential difficulties ensuring electromagnetic compatibility in other environments due to conducted as well as radiated disturbance.

This equipment is supplied as “open type” equipment. It must be mounted within an enclosure that is suitably designed for those specific environmental conditions that will be present, and appropriately designed to prevent personal injury resulting from accessibility to live parts. The interior of the enclosure must be accessible only by the use of a tool. Subsequent sections of this publication may contain additional information regarding specific enclosure type ratings that are required to comply with certain product safety certifications.

See NEMA Standards publication 250 and IEC publication 60529, as applicable, for explanations of the degrees of protection provided by different types of enclosures. Also, see the appropriate sections in this publication, as well as the Allen–Bradley publication 1770–4.1, (“Industrial Automation Wiring and Grounding Guidelines”), for additional installation requirements pertaining to this equipment.

Prepare for Installation

Make sure you have these items:

I/O-group-label set (cat. no. 1771-XB)

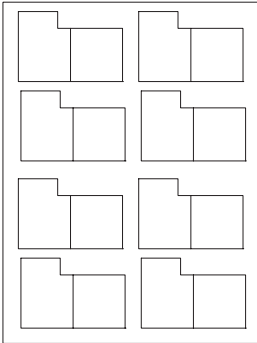

Hardware kit (cat. no. 1771-RK)

plastic keying bands
(number depends on size of chassis)

- 9 1771-A1B
- 18 1771-A2B
- 27 1771-A3B, 1771-A3B1
- 36 1771-A4B

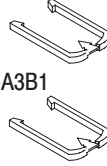

1 star washer



1 cup washer



4 flat washers

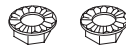

2 #10-32 nuts
with captive lock washers

Documentation

(if you are installing I/O modules or power supplies)

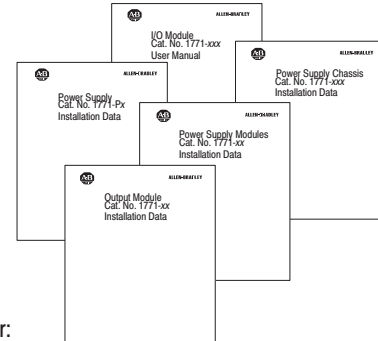

for your:

- programmable controller or I/O adapter module
- external power supply and/or power supply chassis
(if you are using external power supplies)
- communication modules and/or I/O modules
- power-supply modules

Allow Sufficient Mounting Space

For these mounting dimensions	See page
I/O chassis	6
I/O chassis with external power supply	7

Make sure you meet these minimum spacing requirements.

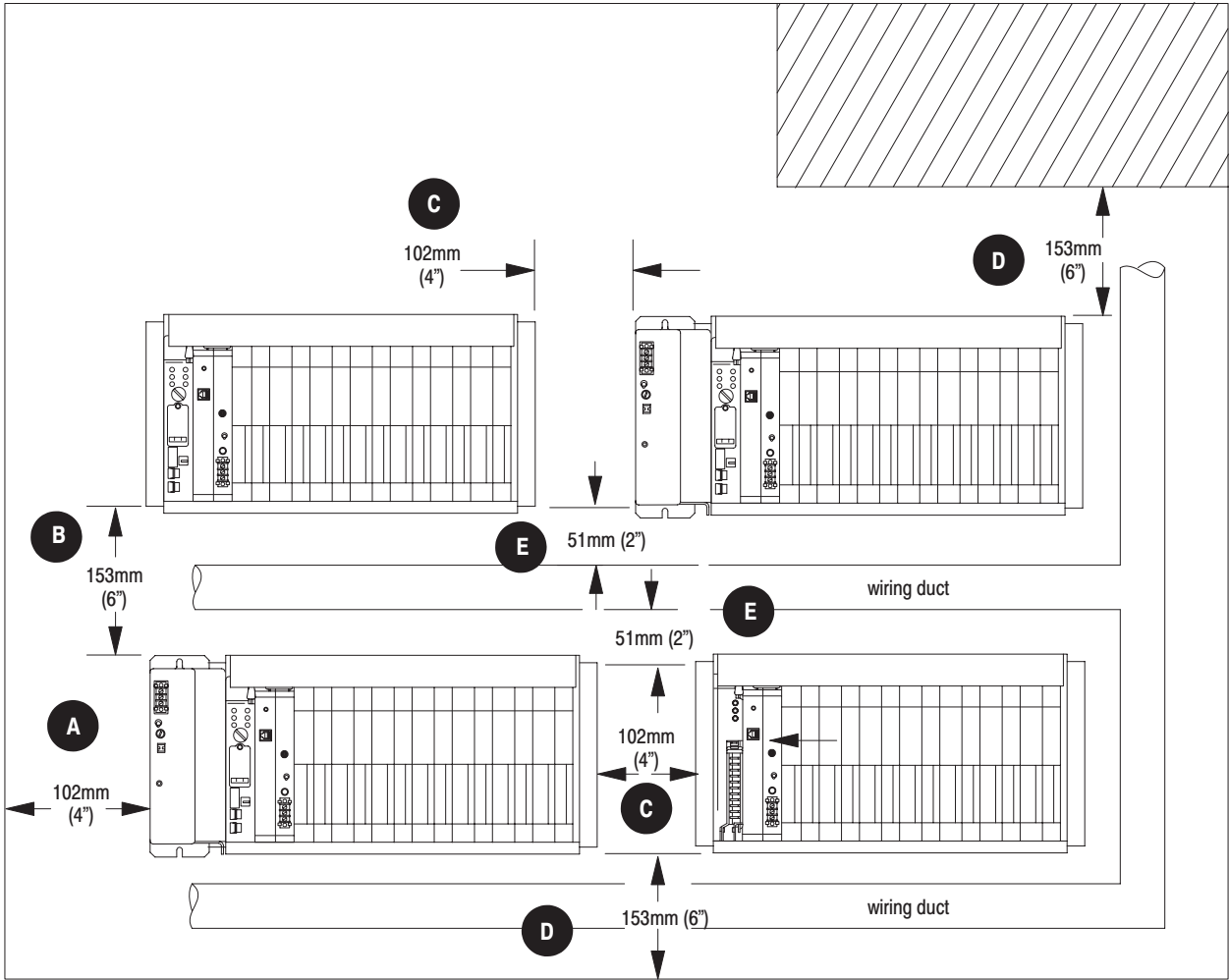

- A** Minimum distance between a major component and the sides of an enclosure is 102mm (4 inches).
- B** Minimum vertical separation between major components is 153mm (6 inches).
- C** Minimum horizontal separation between major components is 102mm (4 inches).
- D** Minimum vertical distance between a major component and the top or bottom of an enclosure is 153mm (6 inches).
- E** Minimum distance between major components and wiring ducts or terminal strips is 51mm (2 inches).

13082

I/O Chassis Mounting Dimensions

1771-A1B
1771-A2B
1771-A3B1
1771-A4B

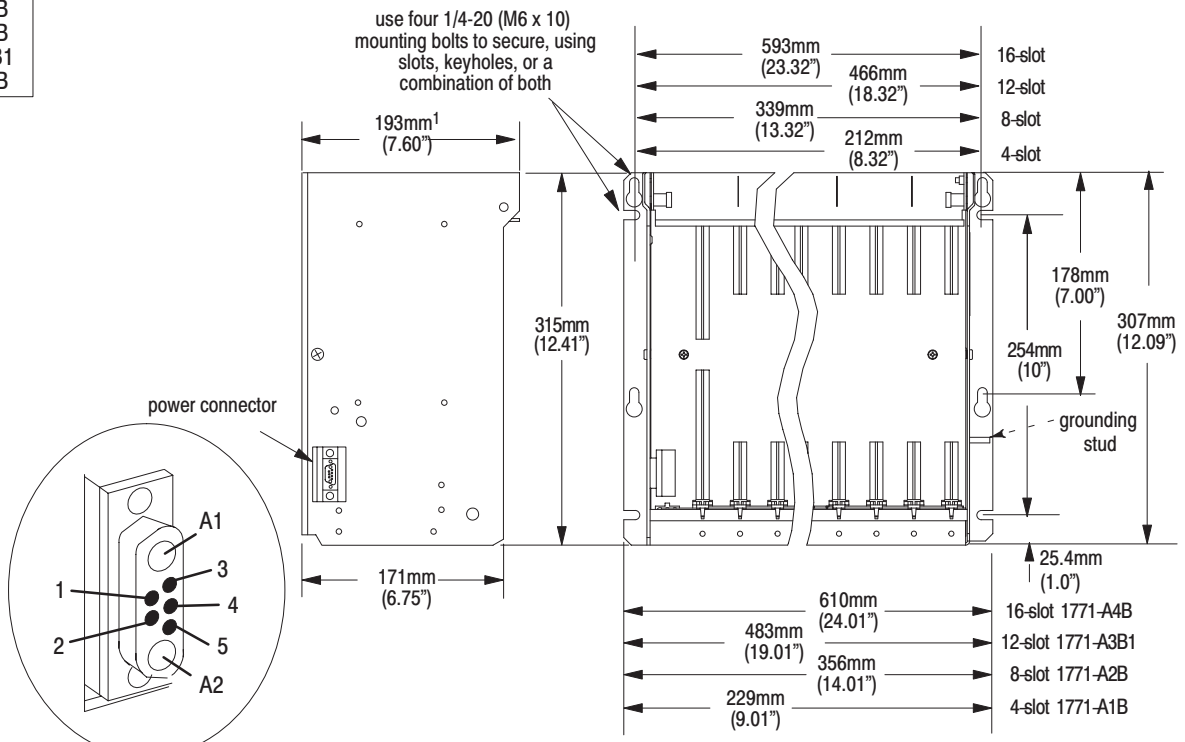

- A1 backplane common
- A2 backplane +5V dc
- 1 no connection
- 2 backplane processor enable
- 3 backplane +5V dc sense
- 4 backplane signal ground sense
- 5 no connection

13445

1771-A3B

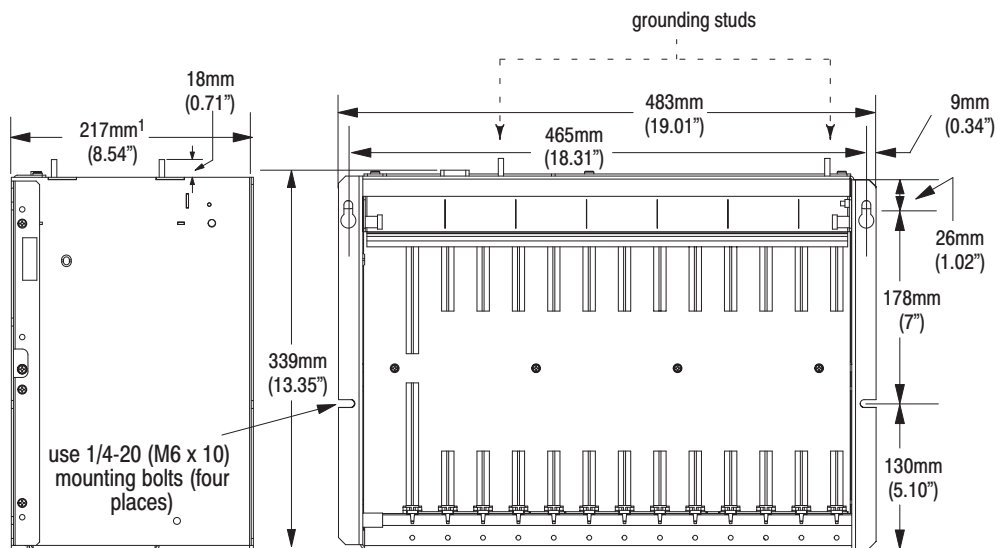

¹Total maximum depth dimension per installation depends on module wiring and connectors.

12450-1

I/O Chassis with External Power Supply Mounting Dimensions

1771-A1B
1771-A2B
1771-A3B1
1771-A4B

You can mount 1771-P1, -P2, -P7 and -PS7 power supplies on the left side plate of the I/O chassis, or up to 5 cable-feet from the I/O chassis.

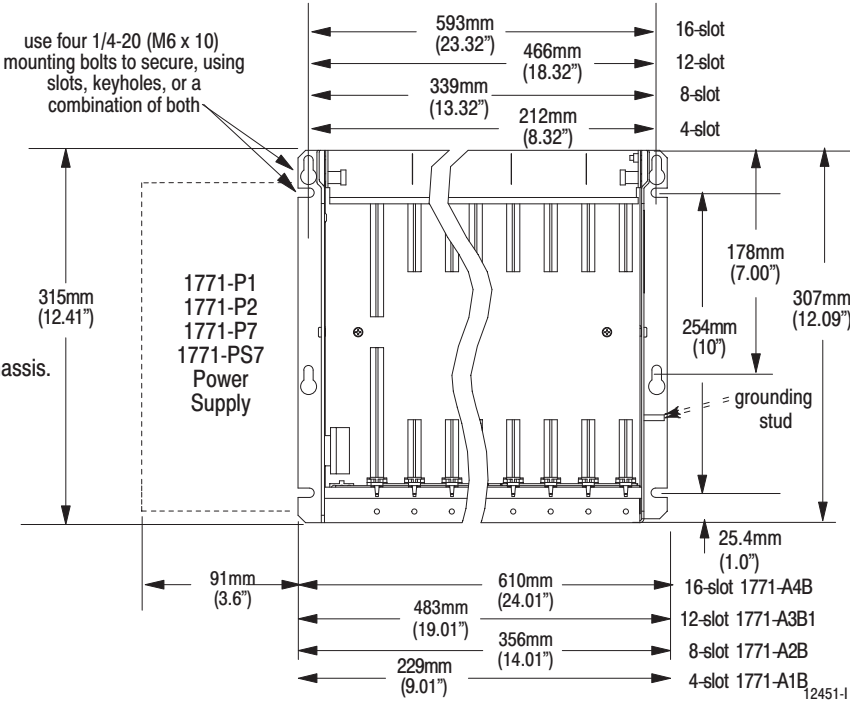

1771-A3B

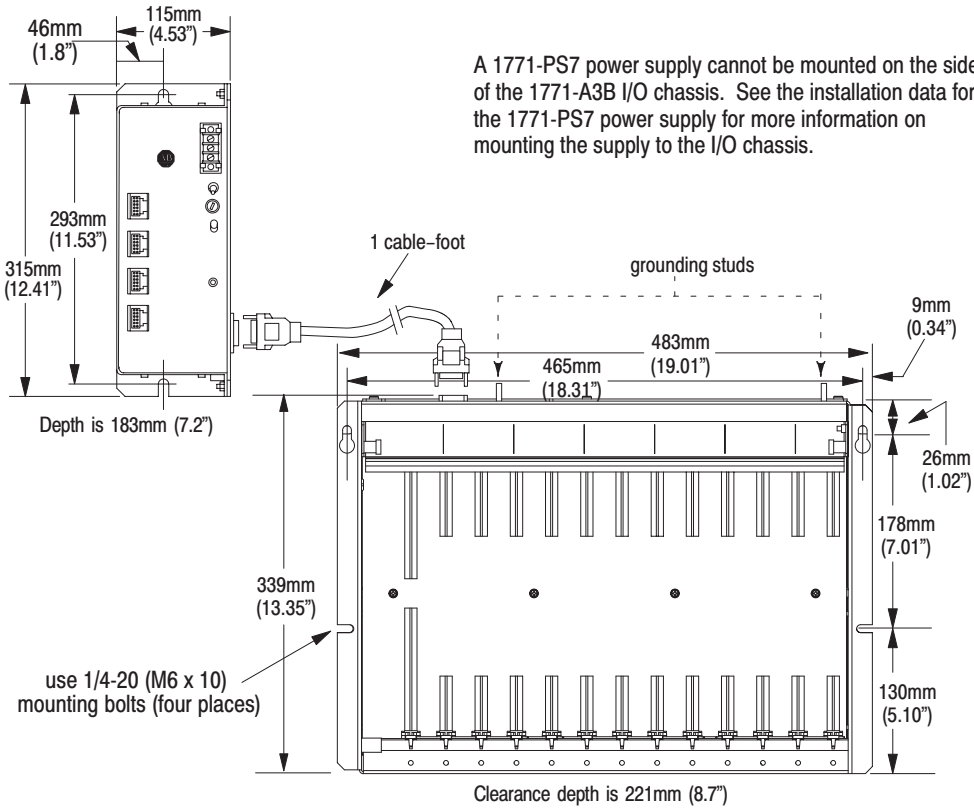

A 1771-PS7 power supply cannot be mounted on the side of the 1771-A3B I/O chassis. See the installation data for the 1771-PS7 power supply for more information on mounting the supply to the I/O chassis.

Mount the I/O Chassis and Ground Bus

If you have this I/O chassis	Type of mount
1771-A1B, -A2B, -A3B1, -A4B	panel mount (rear mount)
1771-A3B	19" rack mount (front mount) or panel mount (rear mount)

Each enclosure must contain a central ground bus. The ground bus is the common connection for each chassis within the enclosure and the enclosure itself. Use either bolts or welded studs to mount the I/O chassis and central ground bus. If you are mounting a chassis to the back panel of an enclosure, use 1/4-20 (M6 x 10) mounting bolts.

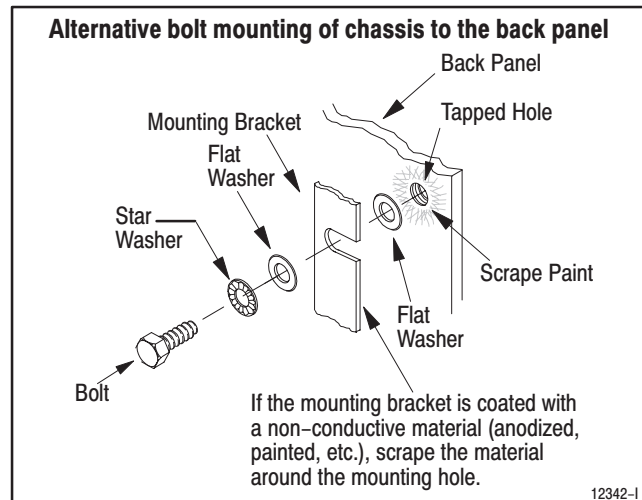
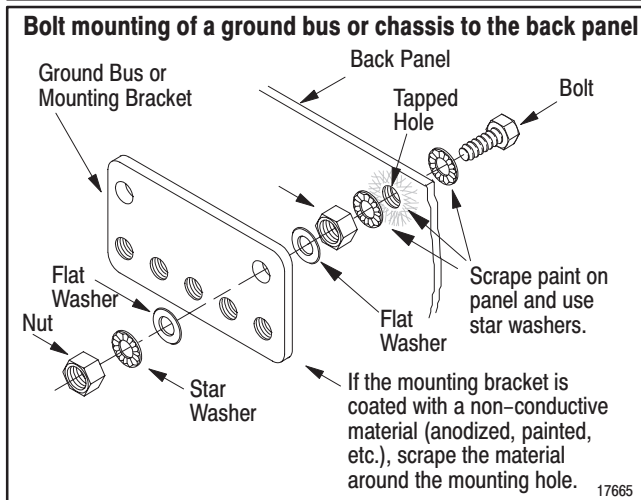
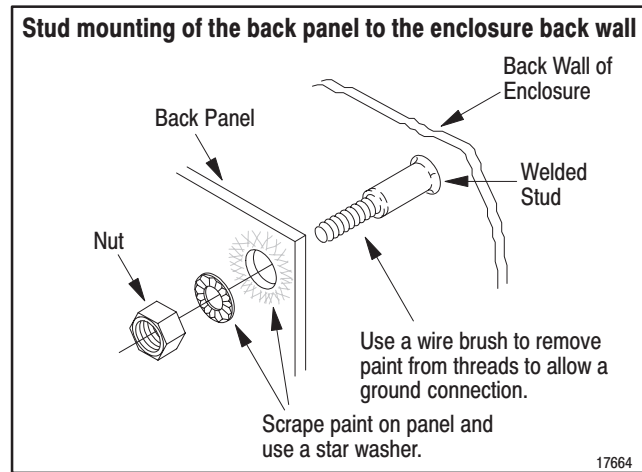
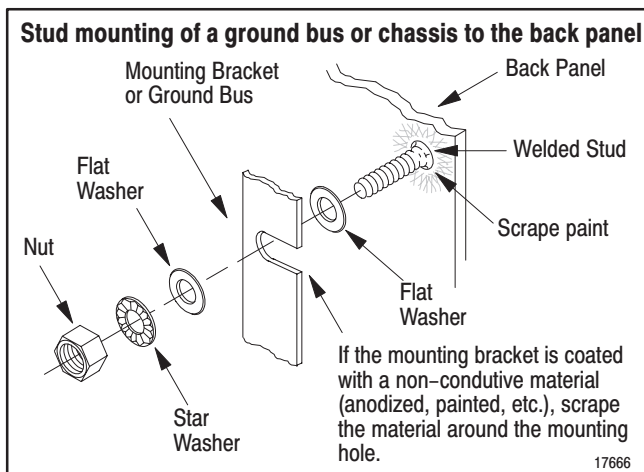

ATTENTION



If the mounting brackets of a chassis do not lay flat before the nuts are tightened, use additional washers as shims so that the chassis will not be warped by tightening the nuts. Warping a chassis could damage the backplane and cause poor connections.

For further information, refer to publication 1770-4.1, "Industrial Automation Wiring and Grounding Guidelines."

Ground Your I/O Chassis

To properly ground your I/O chassis	See page
verify that your system-design plans are using the correct system grounding configuration	9
ground the chassis	10
connect equipment grounding conductors	11
connect a ground bus to the grounding electrode system	12
ground shielded cables	12

Verify Grounding Configuration

Remote I/O Systems

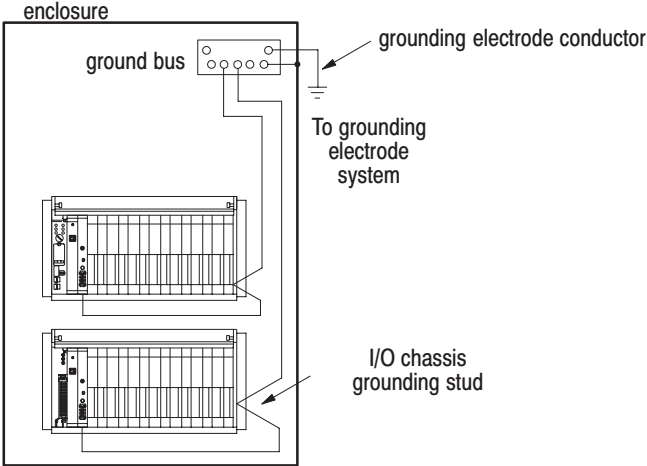

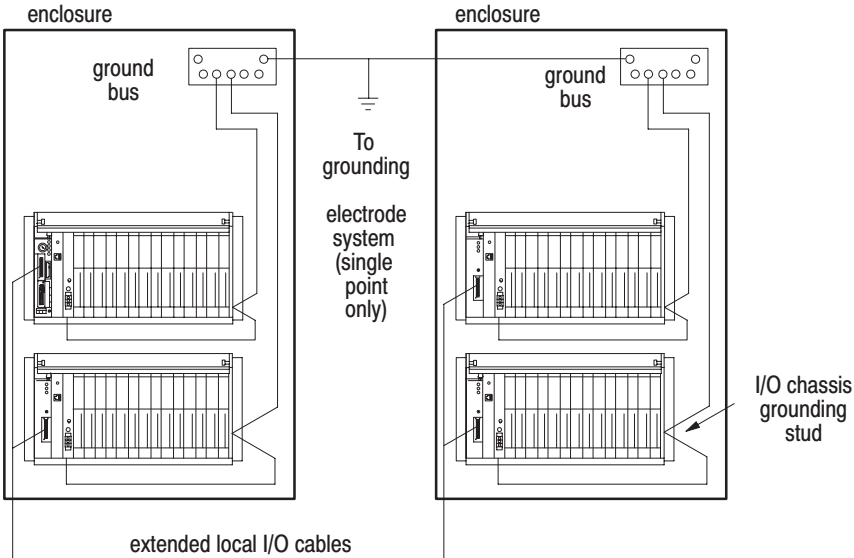

Extended-Local I/O Systems



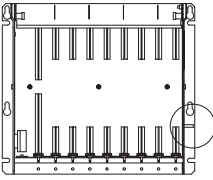
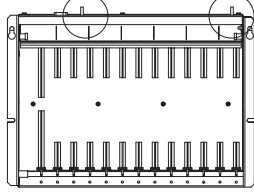

19938

Ground the Chassis

This I/O chassis	Has grounding stud(s) located
1771-A1B 1771-A2B 1771-A3B1 1771-A4B	
1771-A3B ¹	 <div data-bbox="893 567 1412 703"> <p>ATTENTION To prevent ground loops from occurring, use only one grounding stud when grounding your equipment.</p>  </div>

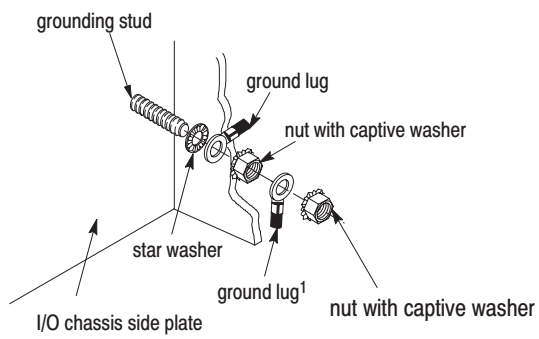
Use the following information, along with the installation manual for your programmable controller to ground the I/O chassis and your I/O modules.

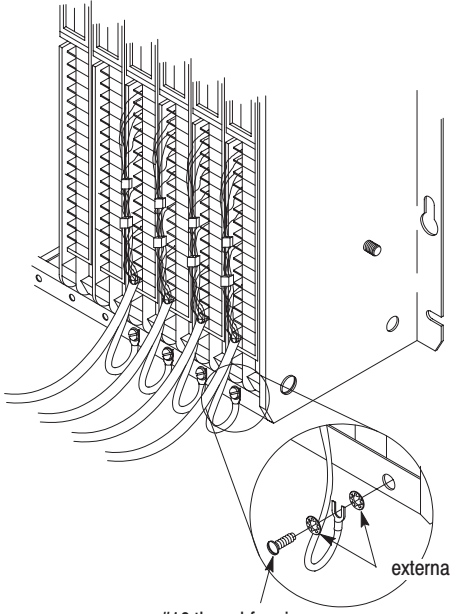
Chassis Ground	Single-point Grounding
<p>When you connect grounding conductors to the I/O chassis grounding stud, place a star washer under the first lug, then place a nut with captive lock washer on top of each ground lug. Torque the nut with captive washer to 18(±3) pound-inches.</p>  <p>¹Use the cup washer if crimp-on lugs are not used.</p>	<p>ATTENTION Use single-point grounding for extended-local I/O system. The systems must be grounded properly for proper performance.</p>   <p>#10 thread-forming screw</p> <p>external-tooth washers</p>

19923

Connect Equipment Grounding Conductor

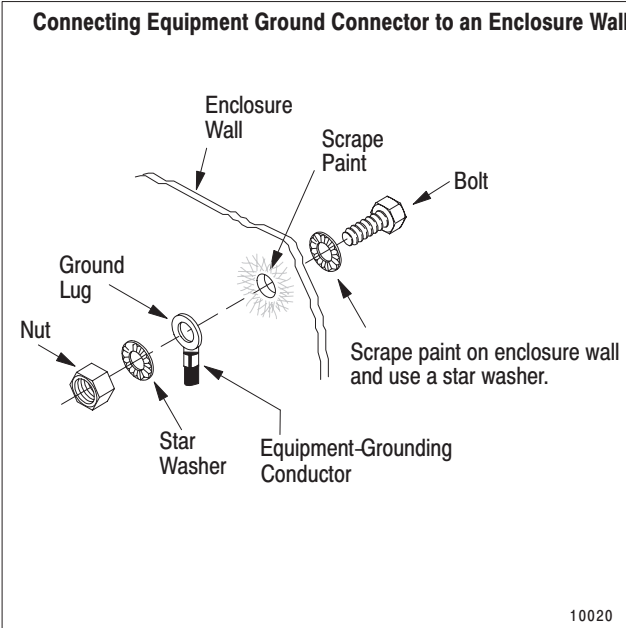
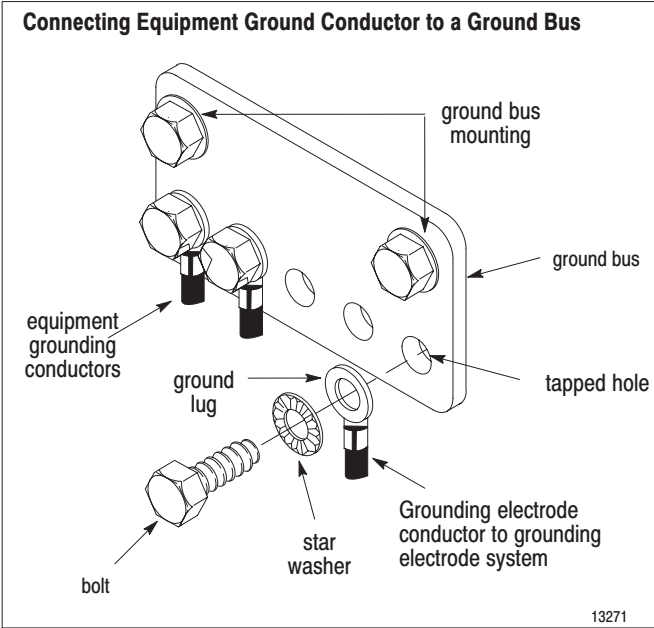

Functional Ground

- use 2.54cm (1in.) copper braid or 10.0mm² (8 AWG) copper wire to connect each chassis, the enclosure and a central ground bus mounted on the back-panel
- use a steel enclosure to guard against electromagnetic interference (EMI)
- make sure the enclosure door viewing window is a laminated screen or a conductive optical substrate (to block EMI)

Protective Earth Ground

- use a 2.5mm² (14 AWG) copper wire for the equipment grounding conductors
- install a bonding wire [2.5mm² (14AWG) minimum] for electrical contact between the door and the enclosure; do not rely on the hinge

IMPORTANT

Do not lay one ground lug directly on top of the other; this type of connection can become loose due to compression of the metal lugs.
 Place the first lug between a star washer and a nut with a captive star washer.
 After tightening the nut, place the second lug between the first nut and a second nut with a captive star washer.

Connect an equipment grounding conductor directly from each chassis to an individual bolt on the ground bus.

For chassis with	Connect the equipment grounding conductor using
a ground stud	the grounding stud

Connect Ground Bus to Grounding-Electrode System

The grounding-electrode system is at earth-ground potential and is the central ground for all electrical equipment and ac power within any facility. Use a grounding-electrode conductor to connect the ground bus to the grounding-electrode system. Use at minimum 8 AWG copper wire for the grounding-electrode conductor to guard against EMI. The National Electrical Code specifies safety requirements for the grounding-electrode conductor.

Ground Shielded Cables

Certain connections require shielded cables to help reduce the effects of electrical noise coupling. Ground each shield at one end only. A shield grounded at both ends forms a ground loop which could cause faulty PLC-5 processor operation.

Ground each shield at the end specified in the appropriate publication for the product.

Avoid breaking shields at junction boxes. Many types of connectors for shielded conductors are available from various manufacturers. If you do break a shield at a junction box:

- connect only category-2 conductors in the junction box
- do not strip the shield back any further than necessary to make a connection
- connect the shields of the two cable segments to ensure continuity along the entire length of the cable

For more information about grounding the chassis, see *Industrial Automation Wiring and Grounding Guidelines* (publication 1770-4.1).



Set the Power Supply Configuration Jumper

Set the power supply configuration jumper according to the power supply you are using.

ATTENTION



If you do not properly configure the power supply configuration jumper, the processor will fail.

If you are using	Set jumper to
a power-supply module or a processor with an integral power supply (1772-LSP, -LWP, -LXP or -LZP)	 <p>Y N "Y" position</p>
a power supply external to the I/O chassis	 <p>Y N "N" position</p>

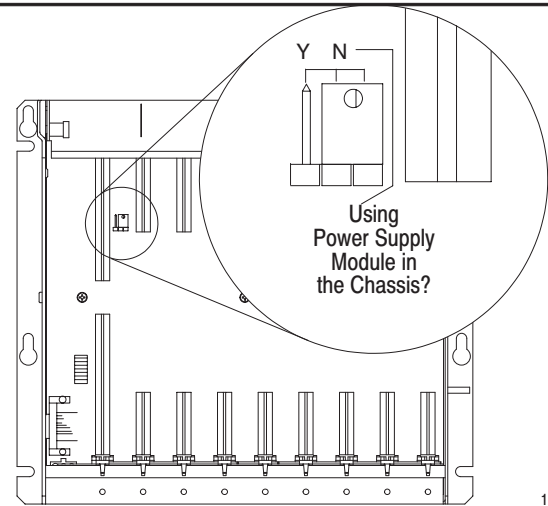

12620-I

IMPORTANT

You cannot power a single I/O chassis with both a power-supply module and an external power supply.

Set the Switches on the Backplane Assembly

Use the installation manual for your programmable controller or adapter module to set the switches.

ATTENTION



If you do not properly configure the backplane switch assembly, various system failures may occur.

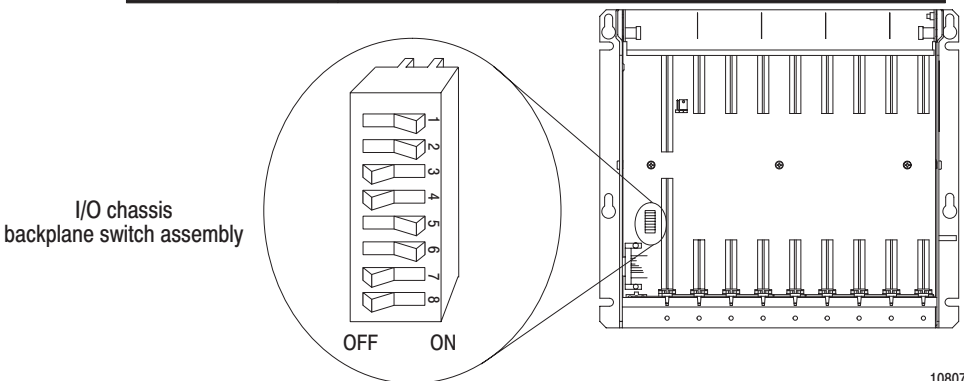

10807-I

Provide Power to the I/O Chassis

Your I/O chassis can receive power through:

- processors with integral power supplies that provide 2-4A
- power-supply modules that provide 3-8A
- external power supplies that provide 6.5-16A
(*external power supplies are not designed for parallel operation*)

Power-supply modules are designed for parallel operation using 1771-CT cables. See your power supply installation documentation (1771 I/O Chassis and Power Supplies product data, publication 1771-2.185) for possible configurations.

IMPORTANT

The 1772-LSP, -LWP, -LXP, and -LZP processor modules already contain a power supply so you can only parallel one additional power-supply module with these processor modules.

ATTENTION



Do not connect an external power supply and a power-supply module to the same I/O chassis; they are incompatible.

WARNING



If you insert or remove any module or power supply while backplane power is on, an electrical arc can occur. This could cause an explosion in hazardous location installations. Be sure power is removed or the area is nonhazardous before proceeding.

WARNING



If you connect or disconnect any cable or wiring with power applied to this module or the device on the other end of the cable or wire, an electrical arc can occur. This could cause an explosion in hazardous location installations. Be sure power is removed or the area is nonhazardous before proceeding.

If your I/O chassis is receiving power through	Then
an external power supply or a power supply chassis	continue with this section
power-supply modules	go to page 16

Attaching a Power Supply to an I/O Chassis

The I/O chassis has two power connectors. You connect the external power supply or power supply chassis (1771-PSC) to the I/O chassis using these connectors and the appropriate power supply cables.

IMPORTANT

Use the installation data for your power supply or power supply chassis (1771 I/O Chassis and Power Supplies product data, publication 1771-2.185) to properly mount it to your I/O chassis.

If you mount a power supply to any I/O chassis, place the flat washers provided between each mounting screw and the power supply mounting bracket. If you do not use the flat washers, the mounting screw intrudes into the I/O chassis and interferes with module insertion.

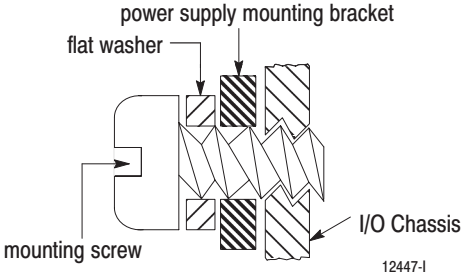

This I/O chassis	Has power connectors located
1771-A1B 1771-A2B 1771-A3B1 1771-A4B	
1771-A3B	

Install Your I/O Modules

The left-most slot of each chassis accepts either a processor module or an I/O adapter module. The other slots in the chassis accept communication modules, I/O modules and power-supply modules.

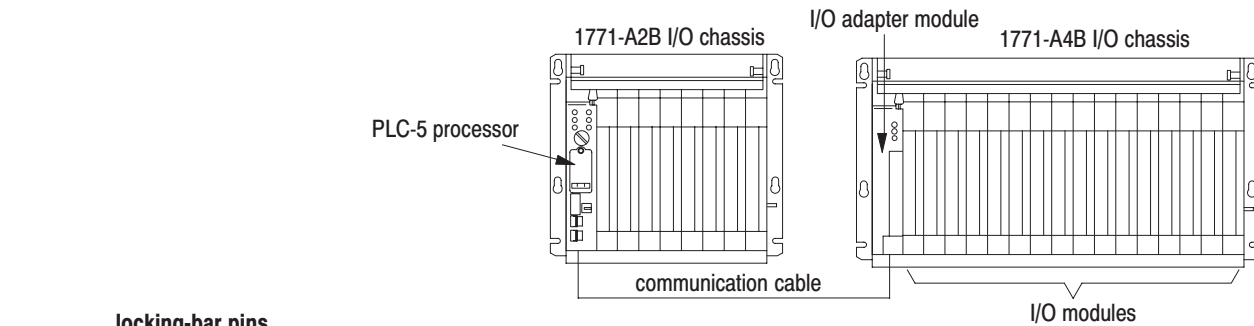

11865

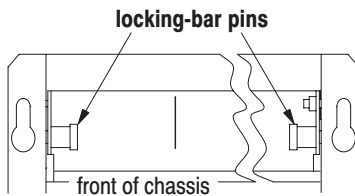

12453-1

To insert a module:

1. Pull the locking-bar pins to release the locking bar and swing it up.
2. Use the installation data/user manual for your module to:
 - a. position the keying bands in the backplane connectors to correspond to the key slots on the module. This prevents you from inserting the wrong module in this slot.

ATTENTION

Observe the following precautions when inserting or removing keys:



- insert or remove keys with your fingers
- make sure that key placement is correct

Incorrect keying or the use of a tool can result in damage to the backplane connector and possible system faults.

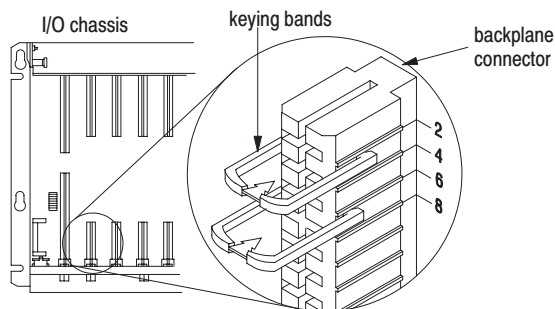

Each I/O module is slotted in two places at the rear edge of the circuit board. These slots are intended to mate with the plastic keys supplied with each chassis.

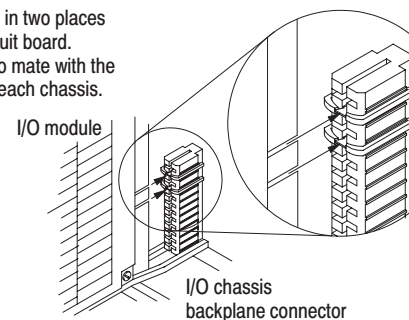

- b. install the module.

IMPORTANT

Firmly press the module into the chassis backplane connector. The chassis locking bar will not close if any modules are not seated properly.

Repeat for each module you install.

- 3. Swing the chassis locking bar down into place to secure the modules. Make sure the locking pins engage.
- 4. Apply the I/O group labels over the scored lines on the I/O chassis locking bar as shown below. On each label, record the I/O rack number, I/O group number and terminal numbering for each module.

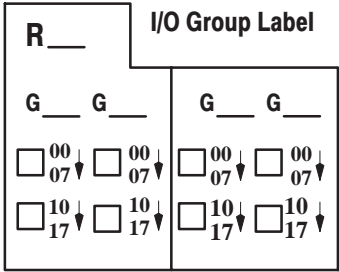

A digital 8-point I/O module has its terminals numbered:

← 00-07 (left slot) or ← 10-17 (right slot)

A digital 16-point I/O module has its terminals numbered:

← 00-07 and ← 10-17

A digital 32-point I/O module in any slot has its terminals numbered for two I/O groups.

1st I/O group - 00-07 and 10-17

2nd I/O group - 00-07 and 10-17

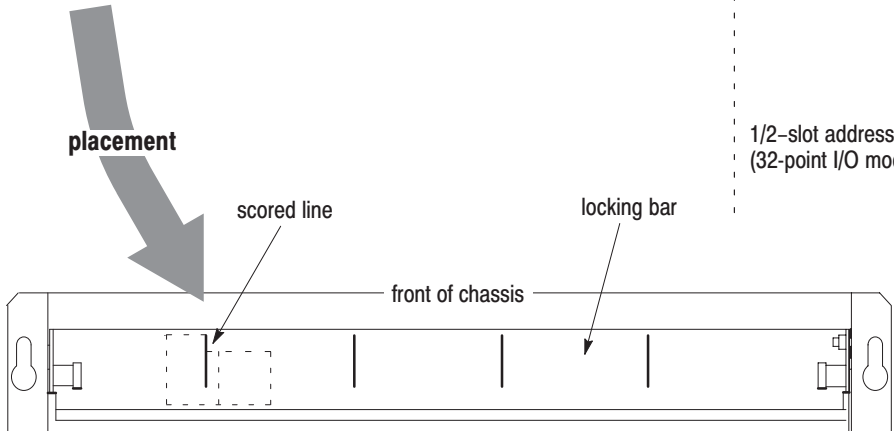

Examples:

2-slot addressing (8-point I/O modules)

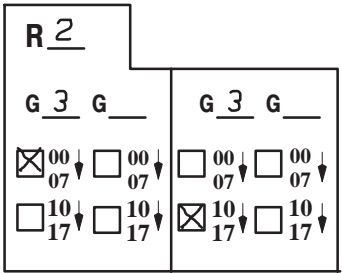

1-slot addressing (16-point I/O modules)

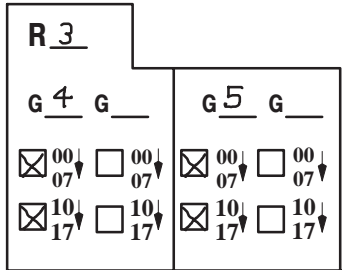

1/2-slot addressing (32-point I/O modules)

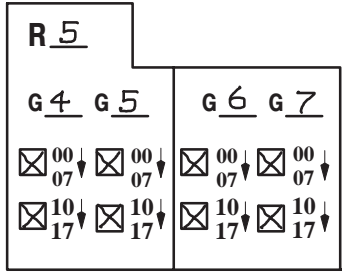

12448-I

- 5. Use your module's installation data to make other wiring connections.
- 6. Apply power to the system and run tests as required.

The following information applies when operating this equipment in hazardous locations:

Products marked “CL I, DIV 2, GP A, B, C, D” are suitable for use in Class I Division 2 Groups A, B, C, and D Hazardous Locations and nonhazardous locations only. Each product is supplied with markings on the rating nameplate indicating the hazardous location temperature code. When combining products within a system, the most adverse temperature code (lowest “T” number) may be used to help determine the overall temperature code of the system. Combinations of equipment in your system are subject to investigation by the local Authority Having Jurisdiction at the time of installation.

WARNING



EXPLOSION HAZARD -

- Do not disconnect equipment unless power has been removed or the area is known to be nonhazardous.
- Do not disconnect connections to this equipment unless power has been removed or the area is known to be nonhazardous. Secure any external connections that mate to this equipment by using screws, sliding latches, threaded connectors, or other means provided with this product.
- Substitution of components may impair suitability for Class I, Division 2.
- If this product contains batteries, they must only be changed in an area known to be nonhazardous.

Informations sur l'utilisation de cet équipement en environnements dangereux:

Les produits marqués CL I, DIV 2, GP A, B, C, D ne conviennent que une utilisation en environnements de Classe I Division 2 Groupes A, B, C, D dangereux et non dangereux. Chaque produit est livré avec des marquages sur sa plaque d'identification qui indiquent le code de température pour les environnements dangereux. Lorsque plusieurs produits sont combinés dans un système, le code de température le plus défavorable (code de température le plus faible) peut être utilisé pour déterminer le code de température global du système. Les combinaisons d'équipements dans le système sont sujettes à inspection par les autorités locales qualifiées au moment de l'installation.

AVERTISSEMENT



RISQUE D'EXPLOSION -

- Couper le courant ou s'assurer que l'environnement est classé non dangereux avant de débrancher l'équipement.
- Couper le courant ou s'assurer que l'environnement est classé non dangereux avant de débrancher les connecteurs. Fixer tous les connecteurs externes reliés à cet équipement à l'aide de vis, loquets coulissants, connecteurs filetés ou autres moyens fournis avec ce produit.
- La substitution de composants peut rendre cet équipement inadapté à une utilisation en environnement de Classe 1, Division 2.
- S'assurer que l'environnement est classé non dangereux avant de changer les piles.

Specifications

I/O Chassis Series B (Cat. No.)	Type of Mount	General Dimensions (W x H x D)	Weight (without modules)	I/O Module Slots	Maximum Backplane Current @ 5V dc	Compatible Replacement for Chassis	
						Series A	Supersedes
1771-A1B	panel	229 x 315 x 193mm (9.0 x 12.4 x 7.6 inches)	3.6kg (8lbs)	4	16A	1771-A1B	1771-A1
1771-A2B	panel	356 x 315 x 193mm (14.0 x 12.4 x 7.6 inches)	4.5kg (10lbs)	8	16A	1771-A2B	1771-A2
1771-A3B	panel or 19" rack	483 x 339 x 221mm (19.0 x 13.35 x 8.7 inches)	5.9kg (13lbs)	12	24A	1771-A3B	none
1771-A3B1	panel	483 x 315 x 193mm (19.0 x 12.4 x 7.6 inches)	5.9kg (13lbs)	12	24A	1771-A3B1	none
1771-A4B	panel	610 x 315 x 193mm (24.0 x 12.4 x 7.6 inches)	7.3kg (16lbs)	16	24A	1771-A4B	1771-A4

General Specifications

Environmental Conditions Operating Temperature	IEC 60068-2-1 (Test Ad, Operating Cold) IEC 60068-2-2 (Test Bd, Operating Dry Heat) IEC 60068-2-14 (Test Nb, Operating Thermal Shock) 32 to 140°F (0 to 60°C)
Storage Temperature	IEC 60068-2-1 (Test Ab, Unpackaged, Nonoperating Cold) IEC 60068-2-2 (Test Bb, Unpackaged, Nonoperating Dry Heat) IEC 60068-2-14 (Test Na, Unpackaged, Nonoperating Thermal Shock) -40 to 185°F (-40 to 85°C)
Relative Humidity	IEC 60068-2-30 (Test Db, Unpackaged, Nonoperating Damp Heat) 5 to 95%, noncondensing
Shock Operating Nonoperating	IEC 60068-2-27 (Test Ea, Unpackaged Shock) 15g 30g
Vibration	IEC 60068-2-6 (Test Fc, Operating) 2g @ 10-500Hz
Emissions	CISPR 11 Group 1, Class A
ESD Immunity	IEC 61000-4-2 4KV Indirect Discharges
Radiated RF Immunity	IEC 61000-4-3 10V/m with 1kHz sine-wave 80% AM from 30MHz to 1000MHz
Enclosure Type Rating	None (open style)

Agency Certification (when product is marked)	UL	UL Listed Industrial Control Equipment
	CSA	CSA Certified Process Control Equipment for Class I, Division 2 Group A, B, C, D Hazardous Locations
	CE ¹	European Union 89/336/EEC EMC Directive, compliant with: EN 50081-2, Industrial Emissions EN 50082-2, Industrial Immunity European Union 73/23/EEC LVD Directive, compliant with: EN 61131-2, Programmable Controllers
	C-Tick ¹	Australian Radiocommunications Act, compliant with: AS/NZS 2064, Industrial Emissions

¹ See the Product Certification link at www.ab.com for Declarations of Conformity, Certificates, and other certification details.



Allen-Bradley, a Rockwell Automation Business, has been helping its customers improve productivity and quality for more than 90 years. We design, manufacture and support a broad range of automation products worldwide. They include logic processors, power and motion control devices, operator interfaces, sensors and a variety of software. Rockwell is one of the world's leading technology companies.



Worldwide representation.

Argentina • Australia • Austria • Bahrain • Belgium • Brazil • Bulgaria • Canada • Chile • China, PRC • Colombia • Costa Rica • Croatia • Cyprus • Czech Republic • Denmark • Ecuador • Egypt • El Salvador • Finland • France • Germany • Greece • Guatemala • Honduras • Hong Kong • Hungary • Iceland • India • Indonesia • Ireland • Israel • Italy • Jamaica • Japan • Jordan • Korea • Kuwait • Lebanon • Malaysia • Mexico • Netherlands • New Zealand • Norway • Pakistan • Peru • Philippines • Poland • Portugal • Puerto Rico • Qatar • Romania • Russia-CIS • Saudi Arabia • Singapore • Slovakia • Slovenia • South Africa, Republic • Spain • Sweden • Switzerland • Taiwan • Thailand • Turkey • United Arab Emirates • United Kingdom • United States • Uruguay • Venezuela • Yugoslavia

Allen-Bradley Headquarters, 1201 South Second Street, Milwaukee, WI 53204 USA, Tel: (1) 414 382-2000 Fax: (1) 414 382-4444



Artisan Technology Group is your source for quality new and certified-used/pre-owned equipment

- FAST SHIPPING AND DELIVERY
- TENS OF THOUSANDS OF IN-STOCK ITEMS
- EQUIPMENT DEMOS
- HUNDREDS OF MANUFACTURERS SUPPORTED
- LEASING/MONTHLY RENTALS
- ITAR CERTIFIED SECURE ASSET SOLUTIONS

SERVICE CENTER REPAIRS

Experienced engineers and technicians on staff at our full-service, in-house repair center

*InstraView*SM REMOTE INSPECTION

Remotely inspect equipment before purchasing with our interactive website at www.instraview.com ↗

WE BUY USED EQUIPMENT

Sell your excess, underutilized, and idle used equipment. We also offer credit for buy-backs and trade-ins. www.artisanng.com/WeBuyEquipment ↗

LOOKING FOR MORE INFORMATION?

Visit us on the web at www.artisanng.com ↗ for more information on price quotations, drivers, technical specifications, manuals, and documentation

Contact us: (888) 88-SOURCE | sales@artisanng.com | www.artisanng.com