



## Artisan Technology Group is your source for quality new and certified-used/pre-owned equipment

- FAST SHIPPING AND DELIVERY
- TENS OF THOUSANDS OF IN-STOCK ITEMS
- EQUIPMENT DEMOS
- HUNDREDS OF MANUFACTURERS SUPPORTED
- LEASING/MONTHLY RENTALS
- ITAR CERTIFIED SECURE ASSET SOLUTIONS

### SERVICE CENTER REPAIRS

Experienced engineers and technicians on staff at our full-service, in-house repair center

### *InstraView*<sup>SM</sup> REMOTE INSPECTION

Remotely inspect equipment before purchasing with our interactive website at [www.instraview.com](http://www.instraview.com) ↗

### WE BUY USED EQUIPMENT

Sell your excess, underutilized, and idle used equipment. We also offer credit for buy-backs and trade-ins. [www.artisanng.com/WeBuyEquipment](http://www.artisanng.com/WeBuyEquipment) ↗

### LOOKING FOR MORE INFORMATION?

Visit us on the web at [www.artisanng.com](http://www.artisanng.com) ↗ for more information on price quotations, drivers, technical specifications, manuals, and documentation

**Contact us:** (888) 88-SOURCE | [sales@artisanng.com](mailto:sales@artisanng.com) | [www.artisanng.com](http://www.artisanng.com)

# Model 2416 Process Controller

## User Manual

Part No HA025041\_12

Date August 2014



**Eurotherm**<sup>®</sup>  
by **Schneider** Electric

This page is intentionally blank

# MODEL 2416 PID CONTROLLER

## INSTALLATION AND OPERATION HANDBOOK

Contents	Page
<b>1. Chapter 1 INSTALLATION</b> .....	<b>1-2</b>
<b>1.1 MECHANICAL INSTALLATION</b> .....	<b>1-3</b>
1.1.1 Controller labels.....	1-3
1.1.2 Outline dimensions.....	1-3
1.1.3 Panel cut-out and recommended minimum spacing of controllers.....	1-3
1.1.4 To install the controller.....	1-3
1.1.5 Unplugging and plugging-in the controller.....	1-3
<b>1.2 Electrical installation</b> .....	<b>1-4</b>
1.2.1 Rear Terminal Layout.....	1-4
1.2.2 Fixed connections.....	1-5
1.2.3 Plug-in module connections.....	1-5
1.2.4 Snubbers.....	1-6
1.2.5 Communications module.....	1-6
1.2.6 Wiring of 2-wire EIA-485 serial communications link.....	1-7
<b>1.3 Typical wiring diagram</b> .....	<b>1-8</b>
1.3.1 Logic Drive Fan Out.....	1-8
<b>1.4 Motorised valve connections</b> .....	<b>1-9</b>
<b>2. Chapter 2 OPERATION</b> .....	<b>2-1</b>
<b>2.1 FRONT PANEL LAYOUT</b> .....	<b>2-2</b>
<b>2.2 basic operation</b> .....	<b>2-3</b>
2.2.1 Alarms.....	2-3
<b>2.3 Operating modes</b> .....	<b>2-3</b>
2.3.1 Automatic mode.....	2-4
2.3.2 Manual mode.....	2-5
<b>2.4 Parameters and how to access them</b> .....	<b>2-6</b>
2.4.1 List header displays.....	2-6
2.4.2 Parameter names.....	2-7
2.4.3 Parameter displays.....	2-7
2.4.4 To change the value of a parameter.....	2-7
<b>2.5 Navigation Diagram</b> .....	<b>2-8</b>
<b>2.6 PArameter tables</b> .....	<b>2-10</b>
<b>2.7 Alarms</b> .....	<b>2-13</b>
2.7.1 Alarm annunciation.....	2-13
2.7.2 Alarm acknowledgement and resetting.....	2-13
2.7.3 Alarm modes.....	2-13
2.7.4 Alarm types.....	2-13
2.7.5 Process alarms.....	2-13
<b>2.8 Diagnostic alarms</b> .....	<b>2-14</b>
<b>3. Chapter 3 ACCESS LEVELS</b> .....	<b>3-1</b>
<b>3.1 THE DIFFERENT ACCESS LEVELS</b> .....	<b>3-1</b>
<b>3.2 SELECTING AN ACCESS LEVEL</b> .....	<b>3-2</b>
<b>3.3 Edit level</b> .....	<b>3-3</b>
3.3.1 Setting operator access to a parameter.....	3-3
3.3.2 Hiding or revealing a complete list.....	3-3
3.3.3 Promoting a parameter.....	3-3
3.3.4 Returning to Operator Level.....	3-3
<b>4. Chapter 4 TUNING</b> .....	<b>4-1</b>
<b>4.1 WHAT IS TUNING?</b> .....	<b>4-1</b>
<b>4.2 AUTOMATIC TUNING</b> .....	<b>4-2</b>
4.2.1 One-shot Tuning.....	4-2
4.2.2 How to tune.....	4-2
4.2.3 Typical automatic tuning cycle.....	4-2
4.2.4 Calculation of the cutback values.....	4-2
4.2.5 Adaptive tune.....	4-2
<b>4.3 MANUAL TUNING</b> .....	<b>4-3</b>
4.3.1 Setting the cutback values.....	4-3
4.3.2 Integral action and manual reset.....	4-4
4.3.3 Automatic droop compensation (Adc).....	4-4
4.3.4 Tune Error.....	4-4
<b>4.4 motorised valve control</b> .....	<b>4-5</b>
4.4.1 Commissioning the Motorised Valve Controller.....	4-6
4.4.2 Adjusting the minimum on-time 'mP L'.....	4-6
4.4.3 Inertia and backlash settings.....	4-6
<b>4.5 Gain scheduling</b> .....	<b>4-7</b>
<b>5. Chapter 5 PROGRAMMER OPERATION</b> .....	<b>5-1</b>
<b>5.1 What Is Setpoint Programming?</b> .....	<b>5-2</b>
<b>5.2 Programmer States</b> .....	<b>5-3</b>
<b>5.3 Running A Program From The Run List</b> .....	<b>5-4</b>
<b>5.4 Running A Program Using The Run/Hold Button</b> .....	<b>5-5</b>
<b>5.5 Automatic Behaviour</b> .....	<b>5-5</b>
5.5.1 Servo.....	5-5

5.5.2	Holdback.....	5-5
5.5.3	Power failure.....	5-6
<b>5.6</b>	<b>Configuring The Programmer .....</b>	<b>5-7</b>
5.6.1	Creating a New Program or Modifying an Existing One.....	5-9
<b>6.</b>	<b>Chapter 6 CONFIGURATION.....</b>	<b>1</b>
6.1	Selecting Configuration Level.....	2
6.2	Selecting a Configuration Parameter .....	3
6.2.1	Parameter names .....	3
6.3	Changing the Passwords .....	3
6.4	Leaving Configuration Level.....	3
6.5	navigation diagram ( <i>PART A</i> ).....	4
6.6	Configuration Parameter Tables.....	6
<b>7.</b>	<b>Chapter 7 User Calibration .....</b>	<b>7-1</b>
7.1	What is the Purpose of User Calibration?.....	7-1
7.2	User Calibration Enable.....	7-1
7.3	Offset Calibration.....	7-2
7.4	Two-point calibration.....	7-3
7.5	Calibration points and Calibration offsets .....	7-6
<b>8.</b>	<b>Chapter 8 LOAD CURRENT MONITORING AND DIAGNOSTICS.....</b>	<b>8-1</b>
8.1	Example Wiring Diagram (For Mode 1 & 2 Operation) .....	8-2
8.2	Operation.....	8-3
8.2.1	To Read Load Current (modes 2 and 5 only) .....	8-3
8.2.2	To Display Load Current Continuously in the Lower Readout (modes 2 and 5 only).....	8-3
8.2.3	Display Modes .....	8-3
8.2.4	How Heater Alarms Are Displayed .....	8-4
8.3	To Set the Alarm Trip Levels.....	8-5
8.4	Short Circuit SSR Alarm and Heater Fail Alarm.....	8-5
8.5	Relay Outputs.....	8-5
8.6	To Configure PDS Load Current Diagnostics .....	8-6
8.7	To Configure the Logic Module For PDS Modes 1 or 2.....	8-6
8.8	To Configure Low and High Current Trip Alarms .....	8-7
8.9	To Attach Soft Alarms To A Relay Output .....	8-7
8.10	The Scaling Factor.....	8-8
8.10.1	To Adjust the Scaling Factor .....	8-8
<b>Appendix A</b>	<b>UNDERSTANDING THE ORDERING CODE .....</b>	<b>A-1</b>
<b>Appendix B</b>	<b>SAFETY and EMC INFORMATION .....</b>	<b>B-1</b>
<b>Appendix C</b>	<b>TECHNICAL SPECIFICATION.....</b>	<b>C-1</b>

“This product is covered by one or more of the following US Patents:  
 5,484,206; Additional patents pending.  
 PDSIO and INSTANT ACCURACY are trademarks of Eurotherm.”

## 1. Chapter 1 INSTALLATION

The 2416 controller is a versatile, high stability temperature or process controller, with self and adaptive tuning, in 1/16 DIN size (48 x 48mm). It has a modular hardware construction, which accepts up to three plug-in output modules and one communications module, to satisfy a wide range of control requirements. All 2416 controllers have a basic 8-segment programmer built-in as standard.

The 2416 is available as either a:

- standard controller: Model 2416/CC
- setpoint programming controller: Models 2416/CP and 2416/P4
- motorised valve controller: Model 2416/VC
- setpoint programming motorised valve controller: Models 2416/VP and 2416/V4

This chapter consists of two parts:

- MECHANICAL INSTALLATION
- ELECTRICAL INSTALLATION

**Before proceeding, please read the chapter called, *Safety and EMC Information*.**

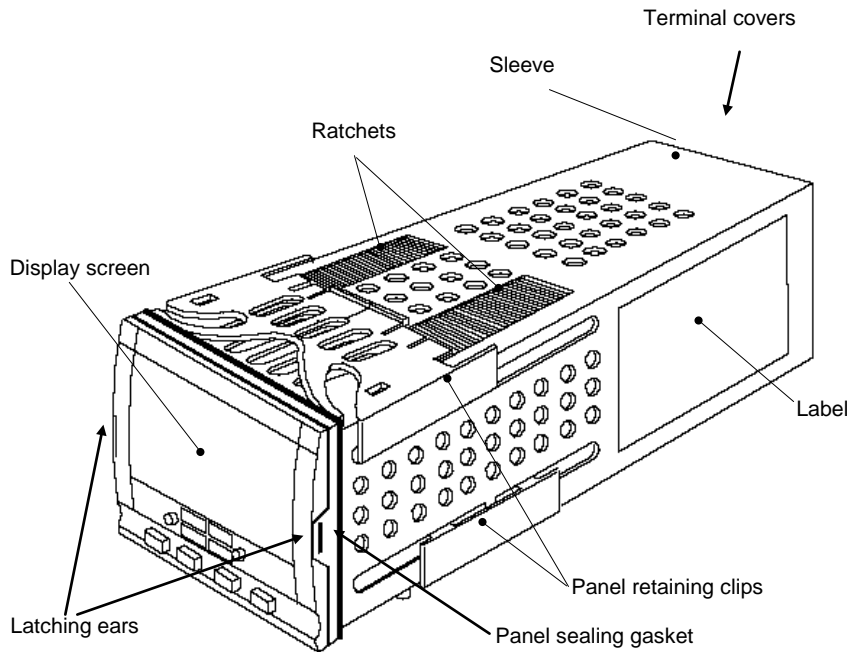

Figure 1-1: 2416 1/16 DIN controller

## 1.1 MECHANICAL INSTALLATION

### 1.1.1 Controller labels

The labels on the sides of the controller identify the ordering code, the serial number, and the wiring connections.

Appendix A, *Understanding the Ordering Code* explains the hardware and software configuration of your particular controller.

### 1.1.2 Outline dimensions

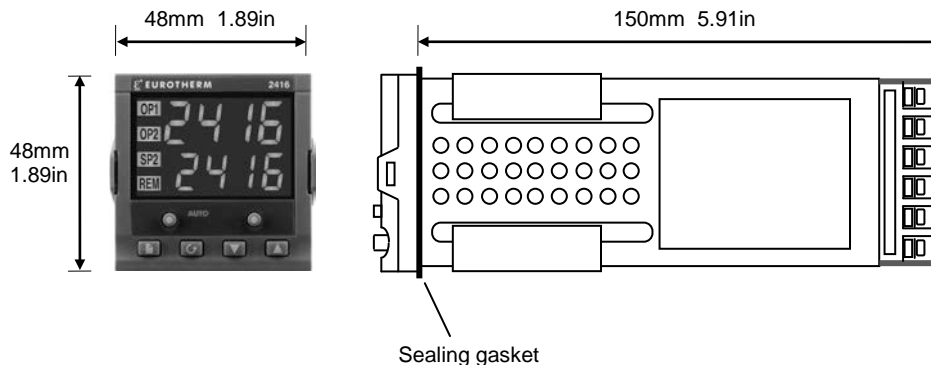

Figure 1-2: Outline Dimensions

The electronic assembly of the controller plugs into a rigid plastic sleeve, which in turn fits into the standard DIN size panel cut-out shown in Figure 1-3.

### 1.1.3 Panel cut-out and recommended minimum spacing of controllers

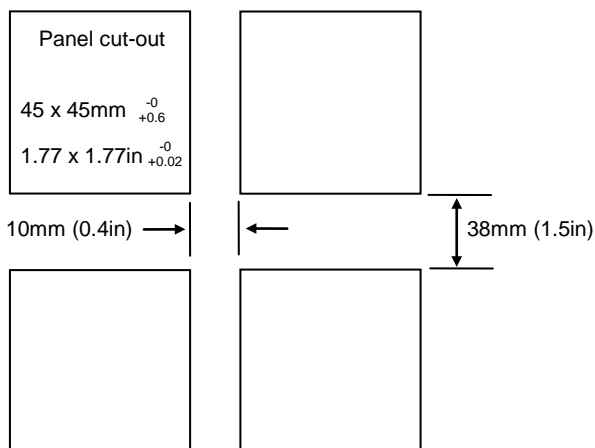

Figure 1-3: Panel cut-outs and minimum spacing

### 1.1.4 To install the controller

1. Prepare the control panel cut-out to the size shown in Figure 1-3.
2. Insert the controller through the panel cut-out.
3. Spring the upper and lower panel retaining clips into place. Secure the controller in position by holding it level and pushing both retaining clips forward.
4. Peel off the plastic film protecting the front of the indicator.

If the panel retaining clips subsequently need removing, in order to extract the controller from the control panel, they can be unhooked from the side with either your fingers or a screwdriver.

### 1.1.5 Unplugging and plugging-in the controller

If required, the controller can be unplugged from its sleeve by easing the latching ears outwards and pulling it forward out of the sleeve. When plugging the controller back into its sleeve, ensure that the latching ears click into place in order to secure the IP65 sealing.

## 1.2 ELECTRICAL INSTALLATION

This section consists of five topics:

- Rear terminal layout
- Fixed connections
- Plug-in module connections
- Typical wiring diagram
- Motorised valve connections



**Warning:** You must ensure that the controller is correctly configured for your application. Incorrect configuration could result in damage to the process being controlled, and/or personal injury. It is your responsibility, as the installer, to ensure that the configuration is correct. The controller may either have been configured when ordered, or may need configuring now. See Chapter 6, Configuration.

All electrical connections are made to the screw terminals at the rear of the controller. These screw terminals accept wire sizes from 0.5 to 2.5mm<sup>2</sup> (14 to 22 awg) and should be tightened to a torque of 0.4 Nm (3.5 lb in). If you wish to use crimp connectors, we recommend AMP part number 16500. These accept wire sizes from 0.5 to 1.5 mm<sup>2</sup> (16 to 22 AWG).

### 1.2.1 Rear Terminal Layout

Terminals are arranged in three columns at the rear of the controller. Each column is protected by a clear plastic hinged cover to prevent hands or metal making accidental contact with live wires. Viewed from the rear and with the controller upright, the right-hand column carries the connections for the power supply and sensor input. The other two columns carry the connections to the plug-in modules. The connections depend upon the type of module installed, if any. To discover which plug-in modules are installed in your controller, please refer to the ordering code and wiring data on the labels on the sides of the controller.

The rear terminal layout is shown below.

Note: The plug-in sleeve supplied with high voltage controllers are keyed to prevent a low voltage unit being inserted into them.

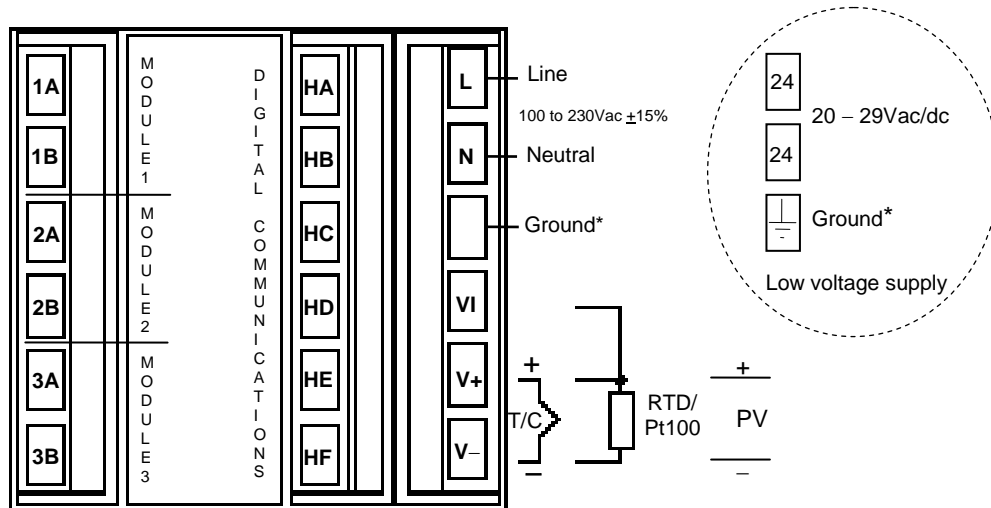

Figure 1-4: Rear terminal layout

\*The ground connection is provided as a return for internal EMC filters. It is not required for safety purposes, but must be connected in order to satisfy EMC requirements.



### 1.2.2 Fixed connections

The power supply and sensor inputs are always wired to the same fixed positions whatever plug-in modules are installed.

#### Power supply connections

These are as shown in Figure 1-4.

#### Sensor input connections

The diagrams below show the connections for the various types of input.

The input will have been configured in accordance with the ordering code.

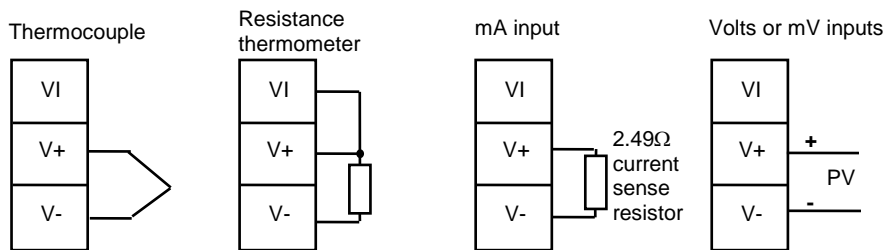

Figure 1-5: Sensor input connections



**Warning:** Do not connect more than one sensor to any one input

### 1.2.3 Plug-in module connections

In Figure 1-4, Modules 1, 2 and 3, and Comms are plug-in modules.

#### Modules 1, 2 and 3

Module positions 1, 2 and 3 each have two terminals. They will accept four types of module: Relay, Logic (non-isolated), Triac, and DC (non-isolated) output.

Collectively, these can be configured to operate in six different ways:

Heating control

Cooling control

Alarm output

Program event output

PDS mode 1\*, which provides logic heating using a Eurotherm TE10S solid state relay with feedback of a load failure alarm.

PDSIO mode 2\*, which provides logic heating using a Eurotherm TE10S solid state relay, with feedback of the load current reading and two alarms: solid state relay failure and heater circuit failure.

\* PDS stands for 'Pulse Density Signalling Input/Output'. This is a proprietary technique developed by Eurotherm for bi-directional transmission of analogue and digital data over a simple 2-wire connection.

### 1.2.4 Snubbers

The relay and triac modules have an internal 15nF/100Ω ‘snubber’ connected across their output, which is used to prolong contact life and to suppress interference when switching inductive loads, such as mechanical contactors and solenoid valves.



**Warning:** When the relay contact is open or the triac is off, the snubber circuit passes 0.6mA at 110Vac and 1.2mA at 240Vac. You must ensure that this current, passing through the snubber, will not hold on low power electrical loads. It is your responsibility as the installer to ensure that this does not happen. If the snubber circuit is not required, it can be removed from the relay module (but not the triac) by breaking the PCB track that runs crosswise adjacent to the edge connectors of the module. Insert the blade of a screwdriver into one of the two slots that bound it, and twist.

The table below shows the module connections and which functions each module can perform. The heating output is normally connected to module 1, the cooling output to module 2 and the alarm output to module 3, although the actual function of each module will depend upon how your controller has been configured.

Note: Module 1 is connected to terminals 1A and 1B

Module 2 is connected to terminals 2A and 2B

Module 3 is connected to terminals 3A and 3B.

Module type	Terminal identity		Possible functions
	A	B	
Relay: 2-pin (2A, 264 Vac max.)			Heating, Cooling, or Alarm output Program event output Valve raise or lower
Logic: non-isolated (18Vdc at 20mA)			Heating, Cooling, or Alarm output PDSIO mode 1, PDSIO mode 2, Program event
Triac (1A, 30 to 264Vac)			Heating, Cooling, Program event Valve raise or lower
DC control: non-isolated (10Vdc, 20mA max.)			Heating, Cooling. Retransmission of PV, setpoint or control output

Table 1-1: Module 1, 2 and 3 connections

To check which modules are installed in your particular controller, and which functions they are configured to perform, refer to the ordering code and the wiring information on the controller side labels.

### 1.2.5 Communications module

The Communications module position will accept any of the modules listed in Table 1-2 below.

The serial communications can be configured for either Modbus, or EI bisynch protocol.

Communications module	Terminal identity (COMMS)					
	HA	HB	HC	HD	HE	HF
2-wire EIA-485 serial communications	–	–	–	Common	A (+)	B (–)
EIA-232 serial communications	–	–	–	Common	Rx	Tx
4-wire EIA-485 serial communications	–	A' (Rx+)	B' (Rx–)	Common	A (Tx+)	B (Tx–)
PDSIO Setpoint retransmission	–	–	–	–	Signal	Common
PDSIO remote setpoint input	--	--	--	--	Signal	Common

Table 1-2: Communications connections

1.2.6 Wiring of 2-wire EIA-485 serial communications link

2-wire EIA-485 is a connection which allows up to 32 controllers to be multi-dropped from a single communications link over a distance of up to 1.2Km. To ensure reliable operation of the communications link, (without data corruption due to noise or line reflections) the connections between the controller should be made using a twisted pair of wires inside a screened cable with the connections terminated with resistors in the manner shown in this diagram. This diagram also shows the use of a Eurotherm KD485 converter to connect the EIA-485 link into a standard EIA-232 computer port.

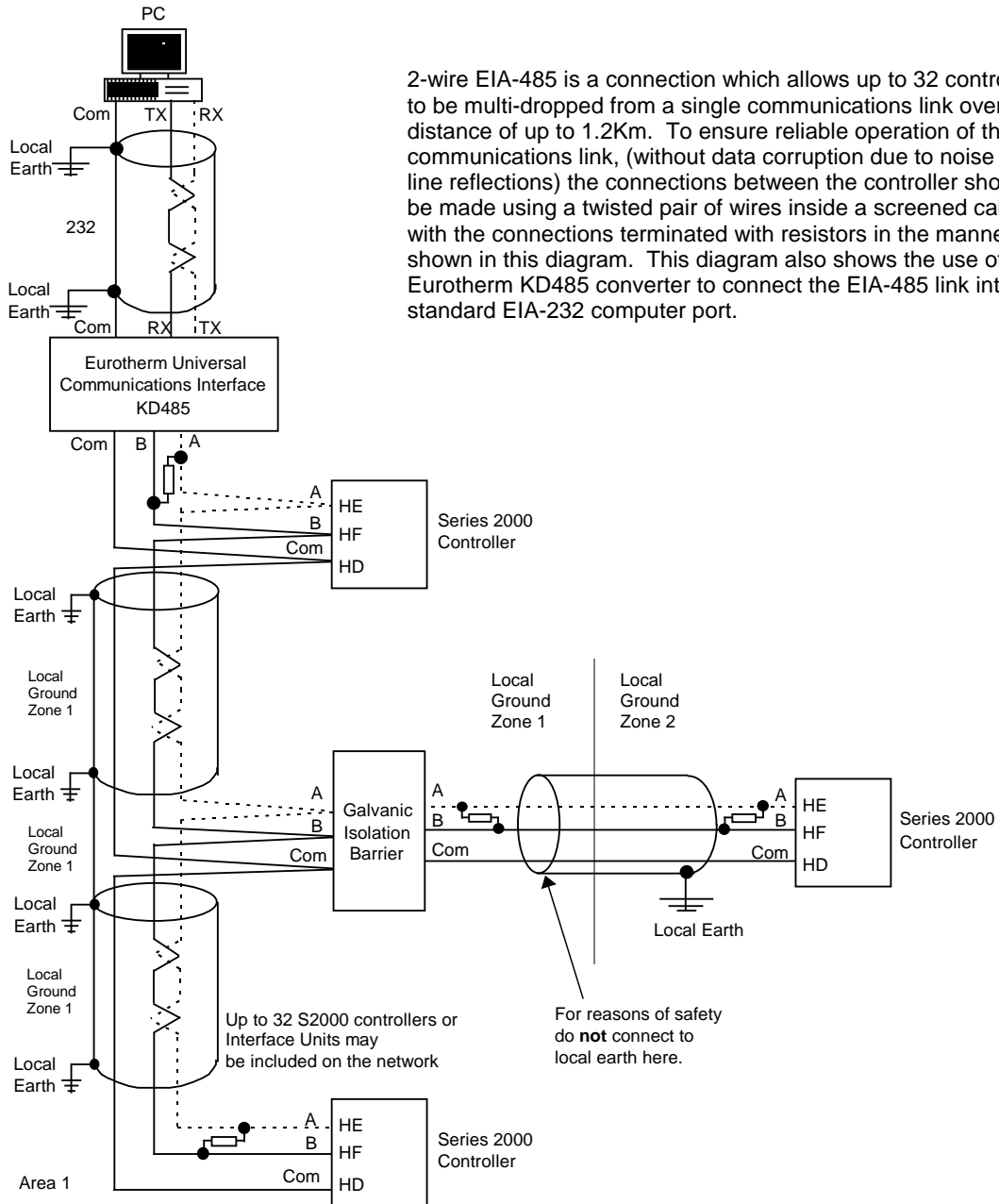

**Note:**  
 All resistors are 220 ohm 1/4W carbon composition.  
 Local grounds are at equipotential. Where equipotential is not available wire into separate zones using a galvanic isolator.  
 Use a repeater (KD845) for more than 32 units.

Figure 1-6: EIA-485 wiring

### 1.3 TYPICAL WIRING DIAGRAM

The example shown in Figure 1-7 is a 2416 heat and cool temperature controller with thermocouple input, logic output driving a solid state relay to provide regulation of power to a heater and triac output driving a cooling solenoid valve.

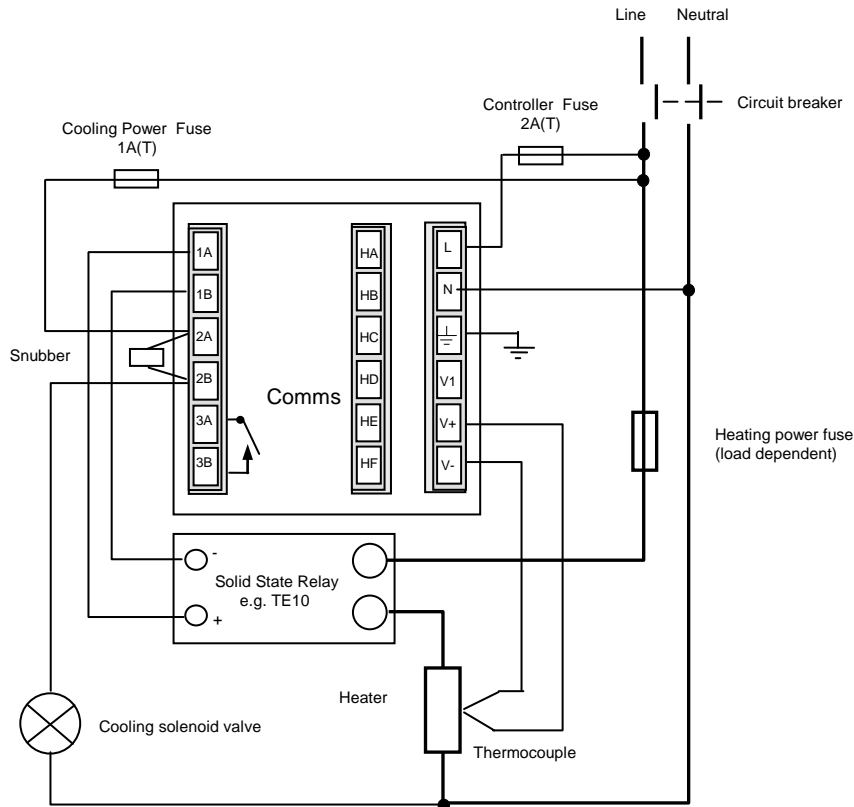

Figure 1-7: Typical wiring diagram

Safety requirements for permanently connected equipment state:

- A switch or circuit breaker shall be included in the building installation
- It shall be in close proximity to the equipment and within easy reach of the operator
- It shall be marked as the disconnecting device for the equipment.

Note: a single switch or circuit breaker can drive more than one instrument.

For logic drive capability see following chart:-

#### 1.3.1 Logic Drive Fan Out

The logic outputs from the 2400 series controllers are capable of driving more than one solid state relay (SSR) in series or parallel. The following table shows the number of SSRs which can be driven depending on type of SSR. S = Series; P = Parallel.

	Drive mA	SVDA	RVDA	TE10S	425S		
		Logic DC	Logic DC	Logic DC	Logic 10V	Logic 24V	Logic 20mA
Logic	18V @20mA	4S6P	4S3P	3S2P	3S3P	1S2P	6S1P
Triple logic	12V @9mA	3S3P	2S1P	2S1P	2S1P	1	4S1P

	450			TC1027CE	TE200S	TC2000C E	RS3DA
	Standard	TTL	Multi-drive	Logic V	Logic DC	Logic DC	Logic DC
Logic	2S3P	1S2P	6S1P	3S3P	3S3P	3S1P	4S2P
Triple logic	1	1	4S1P	2S1P	2S1P	0	0

### 1.4 MOTORISED VALVE CONNECTIONS

Motorised valves are wired to relay, or triac, outputs installed in module positions 1 and 2. The convention is to configure Output 1 as the RAISE output and Output 2 as the LOWER output. The controller does not require a position feedback potentiometer.

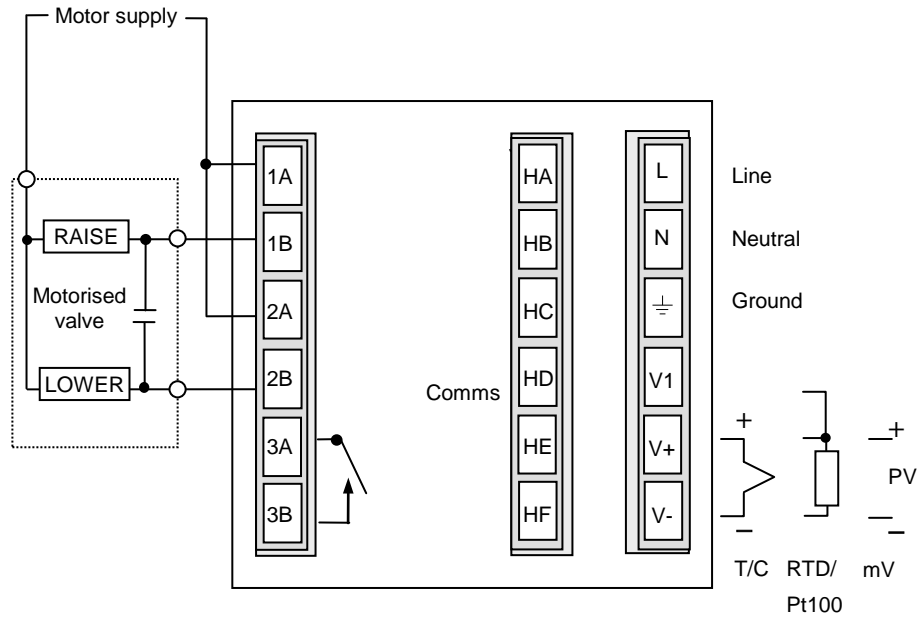

Figure 1-8: Motorised valve controller connections

## 2. Chapter 2 OPERATION

This chapter has nine topics:

- FRONT PANEL LAYOUT
- BASIC OPERATION
- OPERATING MODES
- AUTOMATIC MODE
- MANUAL MODE
- PARAMETERS AND HOW TO ACCESS THEM
- NAVIGATION DIAGRAM
- PARAMETER TABLES
- ALARM MESSAGES

## 2.1 FRONT PANEL LAYOUT

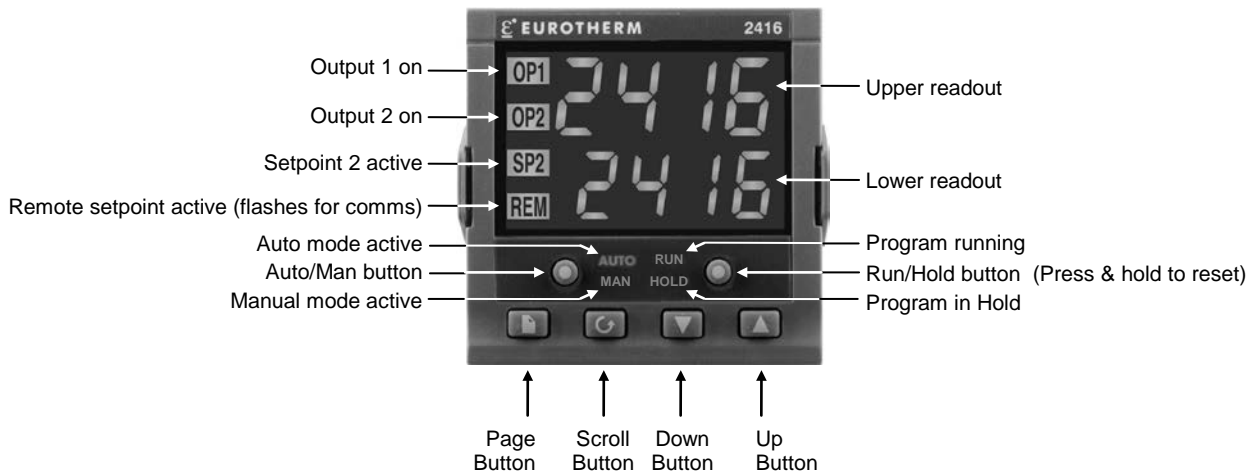

Figure 2-1: Front panel layout







Button or indicator	Name		Explanation
OP1	Output 1	If a DC output is installed, OP1 & OP2 will not light	When lit, it indicates that the output installed in module position 1 is on. This is normally the heating output on a temperature controller.
OP2	Output 2		When lit, it indicates that the output installed in module position 2 is on. This is normally the cooling output on a temperature controller.
SP2	Setpoint 2		When lit, this indicates that setpoint 2, (or a setpoint 3-16) has been selected.
REM	Remote setpoint		When lit, this indicates that a remote setpoint input has been selected. 'REM' will also flash when communications is active.
	Auto/Manual button		When pressed, this toggles between automatic and manual mode: <ul style="list-style-type: none"> <li>• If the controller is in automatic mode the AUTO light will be lit.</li> <li>• If the controller is in manual mode, the MAN light will be lit.</li> </ul> The Auto/Manual button can be disabled in configuration level.
	Run/Hold button		<ul style="list-style-type: none"> <li>• Press once to start a program (RUN light on.)</li> <li>• Press again to hold a program (HOLD light on)</li> <li>• Press again to cancel hold and continue running (HOLD light off and RUN light ON)</li> <li>• Press and hold in for two seconds to reset a program (RUN and HOLD lights off)</li> </ul> The RUN light will flash at the end of a program. The HOLD light will flash during holdback or when a PDS retransmission output is open circuit.
	Page button		Press to select a new list of parameters.
	Scroll button		Press to select a new parameter in a list.
	Down button		Press to decrease a value in the lower readout.
	Up button		Press to increase a value in lower readout.

Table 2-1: Buttons and indicators

## 2.2 BASIC OPERATION

Switch on the power to the controller. It runs through a self-test sequence for about three seconds and then shows the temperature, or process value, in the upper readout and the setpoint in the lower readout. This is called the Home display. It is the one that you will use most often.

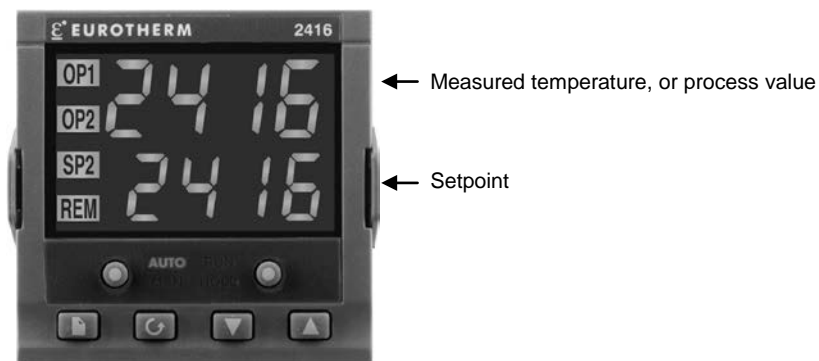





Figure 2-2: Home display

On this display you can adjust the setpoint by pressing the  or  buttons. Two seconds after releasing either button, the display blinks to show that the controller has accepted the new value.

Note: You can get back to the Home display at any time by pressing  and  together. Alternatively you will always be returned to the Home display if no button is pressed for 45 seconds, or whenever the power is turned on. If, however, a flashing alarm message is present the controller reverts to the Home display after 10 seconds.

### 2.2.1 Alarms

If the controller detects an alarm condition, it flashes an alarm message in the Home display. For a list of all the alarm messages, their meaning and what to do about them, see *Alarms* at the end of this chapter.

## 2.3 OPERATING MODES

The controller has two basic modes of operation:

- **Automatic mode** in which the output power is automatically adjusted to maintain the temperature or process value at the setpoint.
- **Manual mode** in which you can adjust the output power independently of the setpoint.

You toggle between the modes by pressing the AUTO/MAN button. The displays which appear in each of these modes are explained in this chapter.

Two other modes are also available:

- **Remote Setpoint mode** in which the setpoint is generated from an external source.

In this mode the REM light will be on.

- **Programmer mode** which is explained in Chapter 5, *Programmer Operation*.



### 2.3.1 Automatic mode

You will normally work with the controller in automatic mode. If the MAN light is on, press the AUTO/MAN button to select automatic mode. The AUTO light will come on.

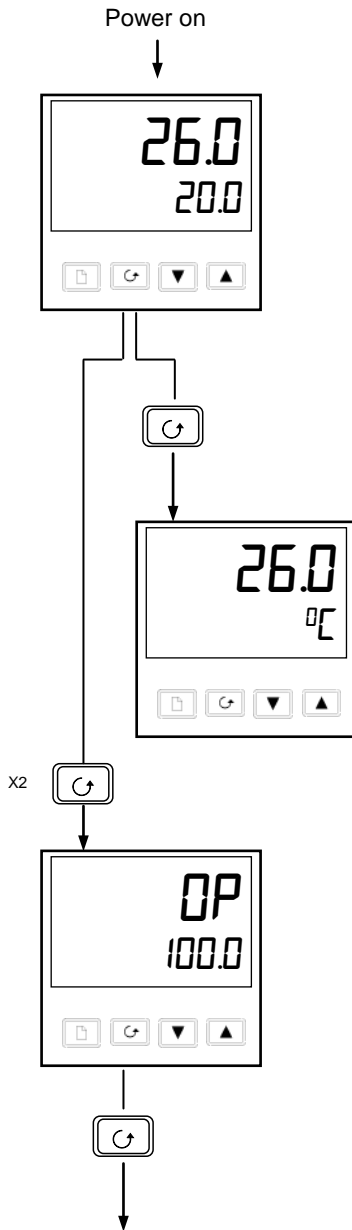

#### The Home display

Check that the AUTO light is on.

The upper readout shows the measured temperature, or process value. The lower readout shows the setpoint.

To adjust the setpoint up or down, press or .

*(Note: If Setpoint Rate Limit has been enabled, then the lower readout will show the active setpoint. If or is pressed, it will change to show and allow adjustment of, the target setpoint.)*

Press once

#### Display units

A single press of the button will flash the display units for 0.5 seconds, after which you will be returned to the **Home** display.

Flashing of the display units may have been disabled in configuration, in which case a single press will take you straight to the display shown below.

Press twice

#### % Output power demand

The % output power demand is displayed in the lower readout. This is a read-only value. You cannot adjust it.

Press and together to return to the **Home** display.

If the controller is configured as Valve Position and Manual is selected the Output Power is displayed as *UPDS*. This is the inferred position of the valve

Press

Pressing from the Output Power display may access further parameters. These may be in this scroll list if the 'Promote' feature has been used (see Chapter 3, *Edit Level*). When you reach the end of this scroll list, pressing will return you to the **Home** display.

### 2.3.2 Manual mode

If the AUTO light is on, press the AUTO/MAN button to select manual mode. The MAN light will come on

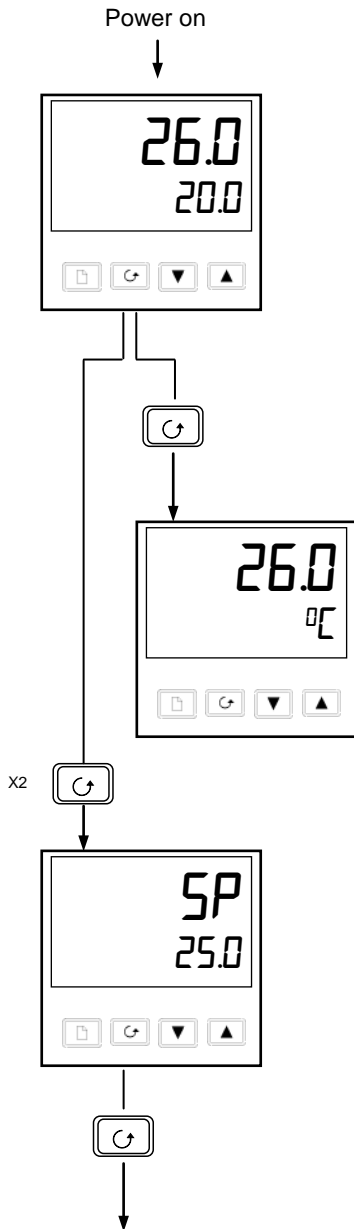

#### The Home display

Check that the MAN light is on.

The upper readout shows the measured temperature or process value. The lower readout shows the % output.

To adjust the output, press or .

*(Note: If Output Rate Limit has been enabled, then the lower readout will show the working output. If or is pressed, it will change to show and allow adjustment of, the target output.)*

Press once

#### Display Units

A single press of will flash the display units for 0.5 seconds, after which you will be returned to the Home display.

Flashing of the display units may have been disabled in configuration in which case you a single press will take you straight to the display shown below.

Press twice

#### Setpoint

To adjust the setpoint value, press or .

Press

Pressing from the Output Power display may access further parameters. Other parameters may be in this scroll list if the 'Promote' feature has been used (see Chapter 3, *Edit Level*). When you reach the end of this scroll list, pressing will return you to the **Home** display.

## 2.4 PARAMETERS AND HOW TO ACCESS THEM

Parameters are settings, within the controller, that determine how the controller will operate. For example, alarm setpoints are parameters that set the points at which alarms will occur. For ease of access, the parameters are arranged in lists as shown in the navigation diagram – section **Error! Reference source not found.**. The lists are:

- Home list*
- Run list*
- Programming list*
- Alarm list*
- Autotune list*
- PID list*
- Motor list*
- Setpoint list*
- Input list*
- Output list*
- Communications list*
- Information list*
- Access list.*

Each list has a 'List Header' display.

### 2.4.1 List header displays

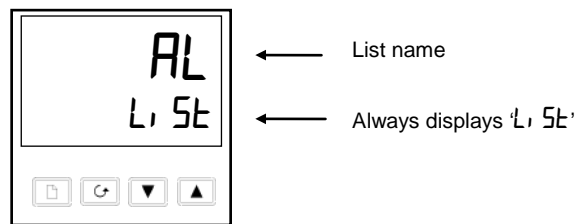





Figure 2-3: Typical list header display

A list header can be recognised by the fact that it always shows 'L, St' in the lower readout. The upper readout is the name of the list. In the above example, 'AL' indicates that it is the Alarm list header. List header displays are read-only.

**To step through the list headers,** press .

Depending upon how your controller has been configured, a single press may momentarily flash the display units. If this is the case, a double press will be necessary to take you to the first list header. Keep pressing  to step through the list headers, eventually returning you to the Home display.

**To step through the parameters within a particular list,** press .

When you reach the end of the list, you will return to the list header. From within a list you can return to the current list header at any time can by pressing . To step to the next list header, press  once again.

### 2.4.2 Parameter names

In the navigation diagram, (Figure 2-5) each box depicts the display for a selected parameter.

The upper readout shows the name of the parameter and the lower readout its value.

The Operator parameter tables later in this chapter list all the parameter names and their meaning.

The navigation diagram shows all the parameters that can, *potentially*, be present in the controller. In practice, only those associated with a particular configuration will appear.

The shaded boxes in the diagram indicate parameters that are hidden in normal operation. To see all the available parameters, you must select Full access level. For more information about this, see Chapter 3, *Access Levels*.

### 2.4.3 Parameter displays

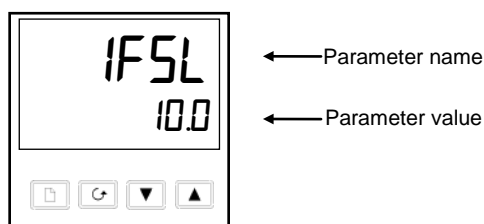



Figure 2-4: Typical parameter display

Parameter displays show the controller's current settings. The layout of parameter displays is always the same: the upper readout shows the parameter name and the lower readout its value. Alterable parameters can be changed using  or . In the above example, the parameter mnemonic is *IFSL* (indicating *Alarm 1, full scale low*), and the parameter value is *10.0*.

### 2.4.4 To change the value of a parameter

First, select the required parameter. The parameter name is shown in the upper readout and the parameter value in the lower readout.

To change the parameter value, press either  or . During adjustment, single presses change the value by one digit.

Keeping the button pressed speeds up the rate of change.

Two seconds after releasing either button, the display blinks to show that the controller has accepted the new value.

## 2.5 NAVIGATION DIAGRAM PART A

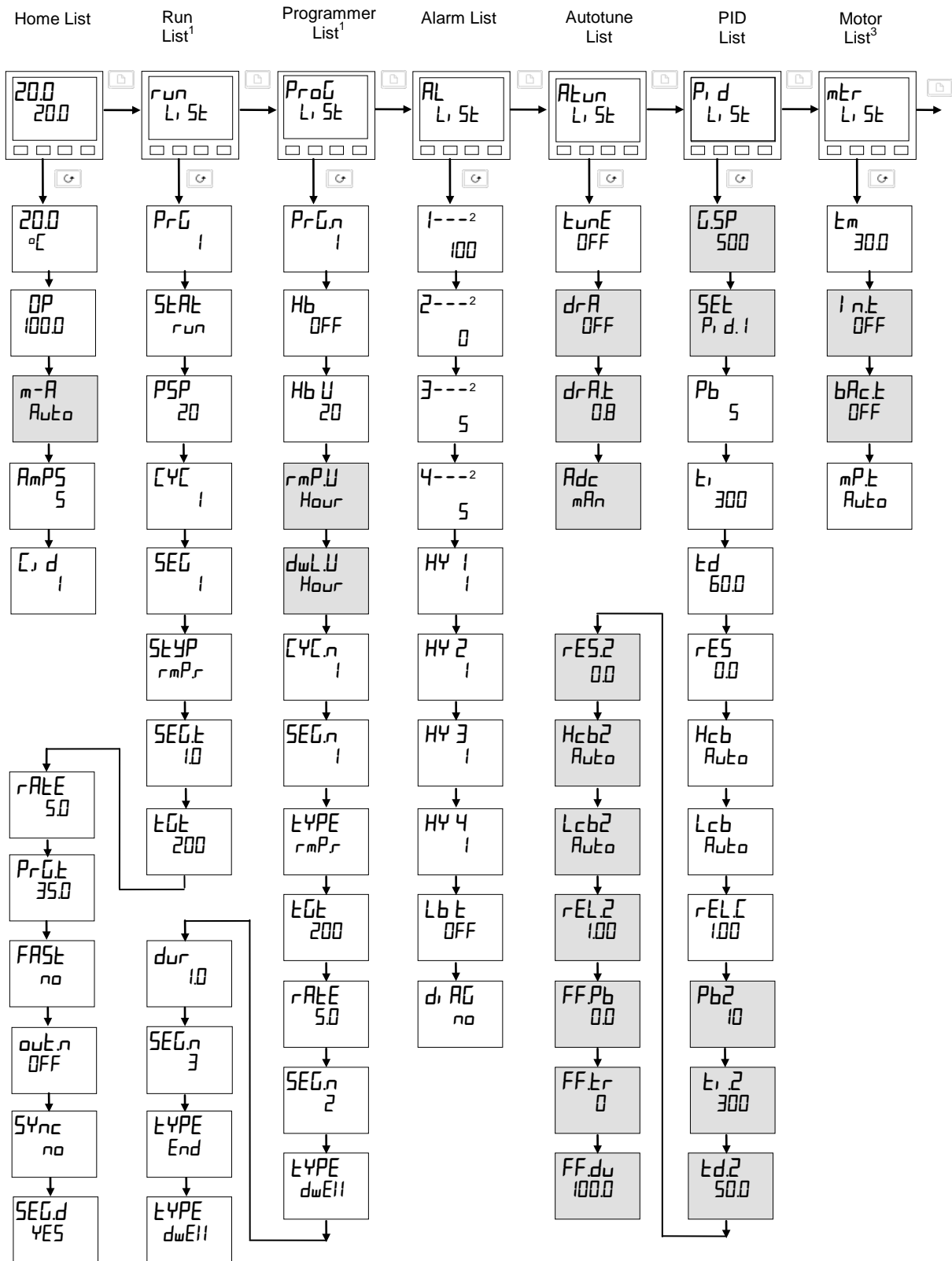

Figure 2-5: Navigation diagram  
Part A

**NAVIGATION DIAGRAM**  
**(PART B)**

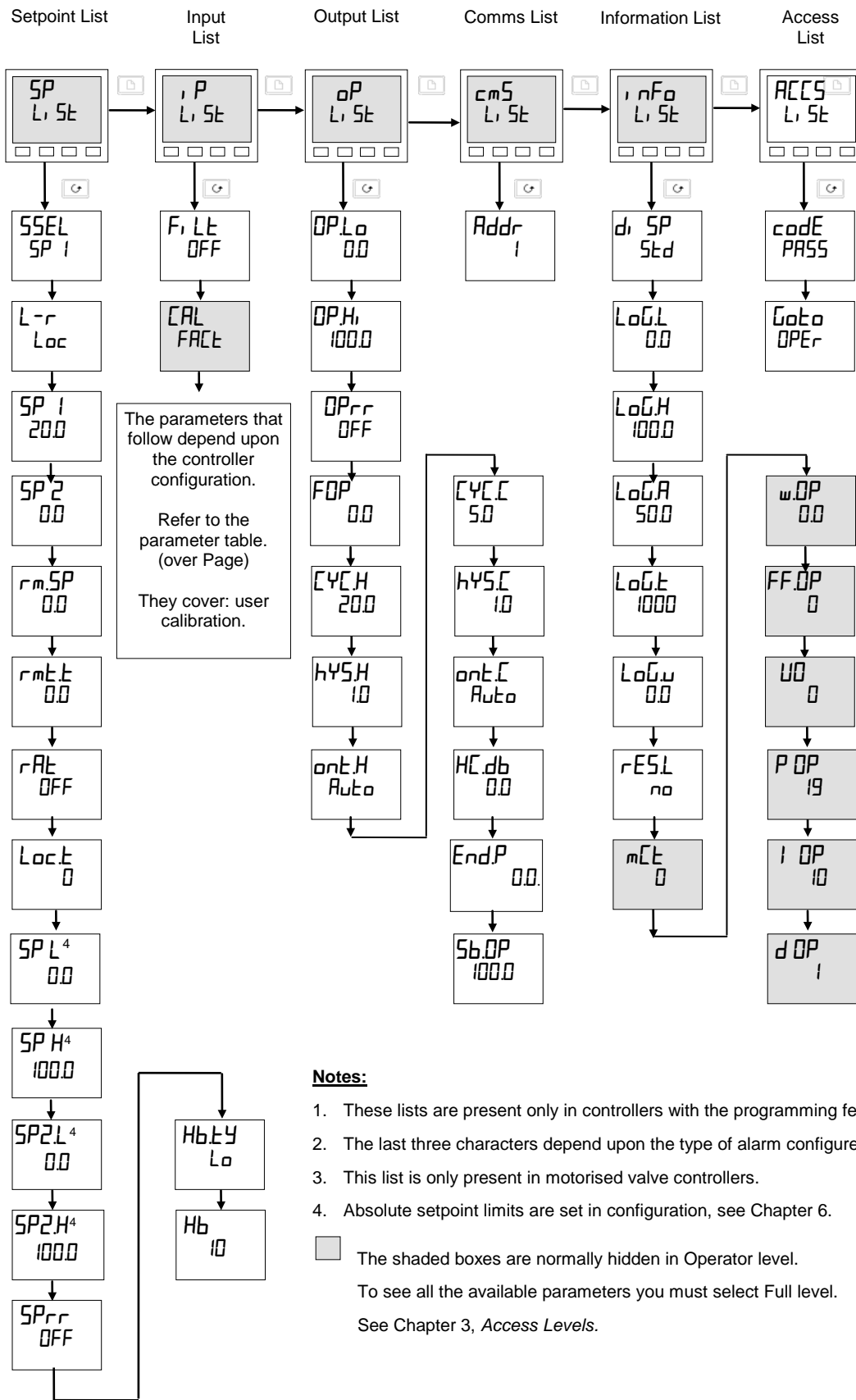

Figure 2-5: Navigation diagram (Part B)

**2.6 PARAMETER TABLES**

Name	Description
<b>Home list</b> <i>Extra parameters may be present if promote feature has been used.</i>	
Home	Measured value and Setpoint
OP	% Output level
SP	Target setpoint (if in Manual mode )
m-A	Auto-man select
AMP5	Heater current (With PDSIO mode 2)
C, d	Customer defined identification number

<b>Program run list – Present only in setpoint programming controllers</b>	
PRG	Active program number (Only on 4 program versions)
STAT	Program status (OFF, run, hold, HbAc, End)
PSP	Programmer setpoint
CYC	Number of cycles remaining in the program
SEG	Active segment number
SEYP	Active segment type
SEGL	Segment time remaining in the segment units
EGE	Target setpoint
rAEE	Ramp rate (if a rate segment)
PRGL	Program time remaining in hours
FAST	Fast run through program (no / YES)
outn	Event output states (OFF / on) (not 8-segment programmer)
Sync	Not operational in 2416. Set to no.
SEGd	Flash active segment type in the lower readout of the home display (no / YES) This parameter can only be changed when the program is in reset

<b>Program edit list – Present only in setpoint programming controllers</b>	
PRGn	Select program number (Only on 4 program versions)
Hb	Holdback type (OFF, Lo, Hi, or bAnd)
Hb U	Holdback value (in display units)
rmpU	Ramp units (Sec, min, or Hour) [for both rmpR and rmpL type segments]
dwLU	Dwell units (Sec, min, or Hour)
CYCn	Number of program cycles (1 to 999, or 'cont')
SEGN	Segment number
TYPE	Segment type:(End) (rmpR=ramp rate) (rmpL=ramp time) (dwell) (STEP) (cALL)

<i>The following parameters depend on the TYPE selected, as shown below.</i>							
	End	rmpR	rmpL	dwell	STEP	cALL	
Hb		✓	✓	✓	✓		Holdback type: OFF, Lo, Hi, or bAnd
EGE		✓	✓		✓		Target setpoint for a 'rmp' or 'STEP' segment
rAEE		✓					Ramp rate for a 'rmpR' segment
dur			✓	✓			'dwell' time / time to target for a 'rmpL' segment
PRGn						✓	cALLed Program number
CYCn						✓	No. of cycles of cALLed program
outn	✓	✓	✓	✓	✓		Event output: OFF/on (not 8-segment programmer)
Sync		✓	✓	✓	✓		Not operational in 2416. Set to no.
EndL	✓						End of prog – dwell, STEP, S OP

Name	Description
<b>Alarm list</b>	
1 - - -	Alarm 1 setpoint value
2 - - -	Alarm 2 setpoint value
3 - - -	Alarm 3 setpoint value
4 - - -	Alarm 4 setpoint value
<i>In place of dashes, the last three characters indicate the alarm type as follows:</i>	
<i>Note: It is possible to indicate only up to four alarm conditions (known as soft alarms). They can be "wired" to operate relays within the limitations of the number of output modules available. For more information see Configuration - Chapter 6.</i>	
-FSL	PV Full scale low alarm
-FSH	PV Full scale high alarm
-dEu	PV Deviation band alarm
-dHi	PV Deviation high alarm
-dLo	PV Deviation low alarm
-LCr	Load Current low alarm
-HCr	Load Current high alarm
-FL2	Not available in 2416
-FH2	Not available in 2416
-LOP	Working Output low alarm
-HOP	Working Output high alarm
-LSP	Working Setpoint low alarm
-HSP	Working Setpoint high alarm
4rAL	Rate of change alarm (AL 4 only)
HY 1	Alarm 1 Hysteresis (display units)
HY 2	Alarm 2 Hysteresis (display units)
HY 3	Alarm 3 Hysteresis (display units)
HY 4	Alarm 4 Hysteresis (display units)
Lb t	Loop Break Time in minutes
d, AC	Enable Diagnostic alarms 'na' / 'YES'

Name	Autotune list
tunE	One-shot autotune enable
drA	Adaptive tune enable
drAL	Adaptive tune trigger level in display units. Range = 1 to 9999
Rdc	Automatic Droop Compensation (PD control only)

Name	Description
P, d	<b>PID list</b>
GSP	If Gain Scheduling has been enabled (see Chapter 4), this parameter sets the PV below which 'P, d, 1' is active and above which 'P, d, 2' is active.
SEt	'P, d, 1' or 'P, d, 2' selected
Pb	Proportional Band (SEt 1) (in display units)
t, 1	Integral Time in secs (SEt 1)
t, d	Derivative Time in secs (SEt 1)
rES	Manual Reset (%) (SEt 1)
Hcb	Cutback High (SEt 1)
Lcb	Cutback Low (SEt 1)
rEL 1	Relative Cool Gain (SEt 1)
Pb 2	Proportional Band (SEt 2)
t, 2	Integral Time in secs (SEt 2)
t, d 2	Derivative Time in secs (SEt 2)
rES 2	Manual Reset (%) (SEt 2)
Hcb 2	Cutback High (SEt 2)
Lcb 2	Cutback Low (SEt 2)
rEL 2	Relative Cool Gain (SEt 2)
<i>The following three parameters are used for cascade control. If this facility is not being used, then they can be ignored.</i>	
FFPb	SP, or PV, feedforward propband
FFt r	Feedforward trim %
FFdu	PID feedforward limits ± %

Name	Motor list - see Table 4-3
t, m	Valve travel time in seconds
i, n, t	Valve inertia time in secs
b, AC, t	Valve backlash time in secs
m, P, t	Minimum ON time of output pulse
U, br	Not available in 2416



Name	Description
<b>SP</b>	<b>Setpoint list</b>
<i>SEEL</i>	Select <i>SP 1</i> to <i>SP 16</i> , depending on configuration
<i>L-r</i>	Local ( <i>Loc</i> ) or remote ( <i>rmE</i> ) setpoint select
<i>SP 1</i>	Setpoint one value
<i>SP 2</i>	Setpoint two value
<i>rmSP</i>	Remote setpoint value
<i>rmE</i>	Remote setpoint trim
<i>rRE</i>	Ratio setpoint
<i>LocE</i>	Local setpoint trim
<i>SP L</i>	Setpoint 1 low limit
<i>SP H</i>	Setpoint 1 high limit
<i>SP2L</i>	Setpoint 2 low limit
<i>SP2H</i>	Setpoint 2 high limit
<i>LocL</i>	Local trim low
<i>LocH</i>	Local trim high
Theses parameters only appear if PDSIO is fitted and <i>LocE</i> (remote setpoint + local trim) in SP Config list is selected	
<i>SPrr</i>	Setpoint Rate Limit
<i>HbEY</i>	Holdback Type for setpoint rate limit ( <i>OFF</i> , <i>Lo</i> , <i>Hi</i> , or <i>bAnd</i> )
<i>Hb</i>	Holdback Value for setpoint rate limit in display units. ( <i>HbEY</i> ≠ <i>OFF</i> )

<i>i P</i>	Input list
<i>FiLE</i>	IP filter time constant (0.0 - 999.9 seconds).
<i>EmiS</i>	Emissivity - when the input is configured for a pyrometer
<i>The next 3 parameters appear only if User Calibration has been enabled. (Refer to Chapter 7.) By default they are hidden when in Operator level. To prevent unauthorised adjustment, we recommend that they are only made available in FULL access level.</i>	
<i>CAL</i>	' <i>FACT</i> ' - reinstates the factory calibration and disables User calibration. Next 2 parameters will not appear. ' <i>USER</i> ' - reinstates any previously set User calibration. All parameters below now appear.
<i>CALS</i>	Selected calibration point - ' <i>nonE</i> ', ' <i>PiL</i> ', ' <i>PiH</i> '
<i>AdJ</i>	User calibration adjust, if <i>CALS</i> = ' <i>PiL</i> ', ' <i>PiH</i> '  <i>Do not make adjustments using the AdJ parameter unless you wish to change the controller calibration.</i>
<i>OFFS.i</i>	IP calibration offset
<i>mU.i</i>	IP measured value (at terminals)
<i>CJC.i</i>	IP Cold Junction Compensation
<i>Li.i</i>	IP Linearised Value
<i>PUSL</i>	PV Select. Not operational in 2416

Name	Description
<b>oP</b>	<b>Output list</b>
<i>Does not appear if Motorised Valve control configured.</i>	
<i>oPLo</i>	Low power limit (%)
<i>oPHi</i>	High power limit (%)
<i>oPrR</i>	Output Rate Limit (% per sec)
<i>FoP</i>	Forced output level (%)
<i>CYCH</i>	Heat cycle time (0.2S to 999.9S)
<i>hYSH</i>	Heat hysteresis (display units)
<i>onEH</i>	Heat output min. on-time (secs) Auto (0.05S), or 0.1 - 999.9S
<i>CYCL</i>	Cool cycle time (0.2S to 999.9S)
<i>hYSL</i>	Cool hysteresis (display units)
<i>onEL</i>	Cool output min. on-time (secs) Auto (0.05S), or 0.1 - 999.9S
<i>HEdb</i>	Heat/cool deadband (display units)
<i>EndP</i>	Power level in programmer in end segment. This is a single parameter for all programs
<i>SbOP</i>	Sensor Break Output Power (%)

<i>cmS</i>	Comms list
<i>Addr</i>	Communications Address

<i>inFo</i>	Information list
<i>diSP</i>	Configure lower readout of Home display to: <i>nonE</i> , <i>Std</i> , <i>Lcur</i> , <i>oP</i> , <i>StRE</i> , <i>PrGE</i>
<i>LoGL</i>	PV minimum
<i>LoGH</i>	PV maximum
<i>LoGA</i>	PV mean value
<i>LoGE</i>	Time PV above Threshold level
<i>LoGu</i>	PV Threshold for Timer Log
<i>rESL</i>	Logging Reset - ' <i>YES/no</i> '
<i>The following set of parameters is for diagnostic purposes.</i>	
<i>mCE</i>	Processor utilisation factor
<i>wOP</i>	Working output
<i>FFoP</i>	Feedforward component of output
<i>UD</i>	PID output to motorised valve
<i>PoP</i>	Proportional component of output
<i>IoP</i>	Integral component of output
<i>doP</i>	Derivative component of output



<i>ACCS</i>	Access List
<i>codE</i>	Access password
<i>Goto</i>	Goto level - <i>OPER</i> , <i>FULL</i> , <i>EdiE</i> or <i>conf</i>
<i>Conf</i>	Configuration password

## 2.7 ALARMS

### 2.7.1 Alarm annunciation

Alarms are flashed as messages in the Home display. A new alarm is displayed as a double flash followed by a pause, old (acknowledged) alarms as a single flash followed by a pause. If there is more than one alarm condition, the display cycles through all the relevant alarm messages. Table 2-1 and Table 2-2 list all of the possible alarm messages and their meanings.

### 2.7.2 Alarm acknowledgement and resetting

Pressing both  and  at the same time will acknowledge any new alarms and reset any latched alarms.

### 2.7.3 Alarm modes

Alarms will have been set up to operate in one of several modes, either:

- **Non-latching**, which means that the alarm will reset automatically when the Process Value is no longer in the alarm condition.
- **Latching**, which means that the alarm message will continue to flash even if the alarm condition no longer exists and will only clear when reset.
- **Blocking**, which means that the alarm will only become active after it has first entered a safe state on power-up.

### 2.7.4 Alarm types

There are **two** types of alarm: **Process alarms** and **Diagnostic alarms**.

### 2.7.5 Process alarms

These warn that there is a problem with the process which the controller is trying to control.

Alarm Display	What it means	Alarm Display	What it means
<u>F</u> S <u>L</u> *	PV Full Scale Low alarm	<u>F</u> L <u>L</u> *	Not available in 2416
<u>F</u> S <u>H</u> *	PV Full Scale High alarm	<u>F</u> H <u>L</u> *	Not available in 2416
<u>d</u> E <u>u</u> *	PV Deviation Band alarm	<u>L</u> O <u>P</u> *	Working Output Low alarm
<u>d</u> H <u>i</u> *	PV Deviation High alarm	<u>H</u> O <u>P</u> *	Working Output High alarm
<u>d</u> L <u>o</u> *	PV Deviation Low alarm	<u>L</u> S <u>P</u> *	Working Setpoint Low alarm
<u>L</u> C <u>r</u> *	Load Current Low alarm	<u>H</u> S <u>P</u> *	Working Setpoint High alarm
<u>H</u> C <u>r</u> *	Load Current High alarm	<u>4</u> r <u>R</u> <u>L</u>	PV Rate of change alarm Always assigned to Alarm 4

\* In place of the dash, the first character will indicate the alarm number.

Table 2-2: Process Alarms

## 2.8 DIAGNOSTIC ALARMS

These indicate that a fault exists in either the controller or the connected devices.

Display shows	What it means	What to do about it
EEEr	<i>Electrically Erasable Memory Error:</i> The value of an operator, or configuration, parameter has been corrupted.	This fault will automatically take you into Configuration level. Check all of the configuration parameters before returning to Operator level. Once in Operator level, check all of the operator parameters before resuming normal operation. If the fault persists, or occurs frequently, contact Eurotherm.
5br	<i>Sensor Break:</i> Input sensor is unreliable or the input signal is out of range.	Check that the sensor is correctly connected.
Lbr	<i>Loop Break</i> The feedback loop is open circuit.	Check that the heating and cooling circuits are working properly.
LdF	<i>Load failure</i> Indication that there is a fault in the heating circuit or the solid state relay.	This is an alarm generated by feedback from a Eurotherm TE10S solid state relay (SSR) operating in PDSIO mode 1 - see Chapter 1, <i>Electrical Installation</i> . It indicates either an open or short circuit SSR, blown fuse, missing supply or open circuit heater.
SSrF	<i>Solid state relay failure</i> Indication that there is a fault in the solid state relay.	This is an alarm generated by feedback from a Eurotherm TE10S solid state relay (SSR) operating in PDSIO mode 2 - see Chapter 1, <i>Electrical Installation</i> . It indicates either an open or short circuit condition in the SSR.
HtrF	<i>Heater failure</i> Indication that there is a fault in heating circuit.	This is an alarm generated by feedback from a Eurotherm TE10S solid state relay (SSR) operating in PDSIO mode 2 - see Chapter 1, <i>Electrical Installation</i> . It indicates either a blown fuse, missing supply, or open circuit heater.
CTOP	<u>C</u> urrent <u>T</u> ransformer <u>O</u> pen <u>C</u> ircuit	Indicates that the PDS input is open circuit. Mode 5 only
CTSh	<u>C</u> urrent <u>T</u> ransformer <u>S</u> hort <u>C</u> ircuit	Indicates that the PDS input is short circuit Mode 5 only
HwEr	<i>Hardware error</i> Indication that a module is of the wrong type, missing, or faulty.	Check that the correct modules are fitted.
no, o	<i>No I/O</i> None of the expected I/O modules is fitted.	This error message normally occurs when pre-configuring a controller without installing any of the required I/O modules.
rmEF	<i>Remote input failure.</i> Either the PDSIO input, or the remote DC input, is open or short circuit	Check for open, or short circuit wiring on the PDSIO, or remote DC, input.
LLLL	<i>Out of range low reading</i>	Check the value of the input.
HHHH	<i>Out of range high reading</i>	Check the value of the input.
Err1	<i>Error 1: ROM self-test fail</i>	Return the controller for repair.
Err2	<i>Error 2: RAM self-test fail</i>	Return the controller for repair.
Err3	<i>Error 3: Watchdog fail</i>	Return the controller for repair.
Err4	<i>Error 4: Keyboard failure</i> Stuck button, or a button was pressed during power up.	Switch the power off and then on, without touching any of the controller buttons.
Err5	<i>Error 5: Faulty internal communications.</i>	Check printed circuit board interconnections. If the fault cannot be cleared, return the controller for repair.
Err6	Digital filter chip faulty or loose board inside controller	Return the controller for repair.
Err7	PV id failure/PSU failure	Return the controller for repair.
Err8	Module 1 id error	Faulty or loose module or may be isolation problem
Err9	Module 2 id error	Faulty or loose module or may be isolation problem
ErrA	Module 3 id error	Faulty or loose module or may be isolation problem
dCF	DC output fail	Return the controller for repair
tEr	Tune error – shown If any one stage of the auto-tuning process exceeds two hours	Check response time of process: check that the sensor has not failed: check that the loop is not broken. Acknowledge by pressing 'page' key and 'scroll' key together
Pbr	Potentiometer break	Check that the feedback potentiometer is correctly connected or the pot is not open circuit

Table 2-3: Diagnostic Alarms

### 3. Chapter 3 ACCESS LEVELS

This chapter describes the different levels of access to the operating parameters within the controller.

There are three topics:

- THE DIFFERENT ACCESS LEVELS
- SELECTING AN ACCESS LEVEL
- EDIT LEVEL

#### 3.1 THE DIFFERENT ACCESS LEVELS

There are four access levels:

- **Operator level**, which you will normally use to operate the controller.
- **Full level**, which is used to commission the controller.
- **Edit level**, which is used to set up the parameters that you want an operator to be able to see and adjust when in Operator level.
- **Configuration level**, which is used to set up the fundamental characteristics of the controller.

Access level	Display shows	What you can do	Password Protection
Operator	<i>OPER</i>	In this level, operators can view and adjust the value of parameters defined in Edit level (see below).	No
Full	<i>FULL</i>	In this level, all the parameters relevant to a particular configuration are visible. All alterable parameters may be adjusted.	Yes
Edit	<i>Edi t</i>	In this level, you can determine which parameters an operator is able to view and adjust in Operator level. You can hide, or reveal, complete lists, individual parameters within each list and you can make parameters read-only or alterable. (See Edit level at the end of this chapter).	Yes
Configuration	<i>conF</i>	This special level allows access to set up the fundamental characteristics of the controller.	Yes

Table 3-1: Access levels

### 3.2 SELECTING AN ACCESS LEVEL

Access to Full, Edit or Configuration levels is protected by a password to prevent unauthorised access.

If you need to change the password, see Chapter 6, *Configuration*.

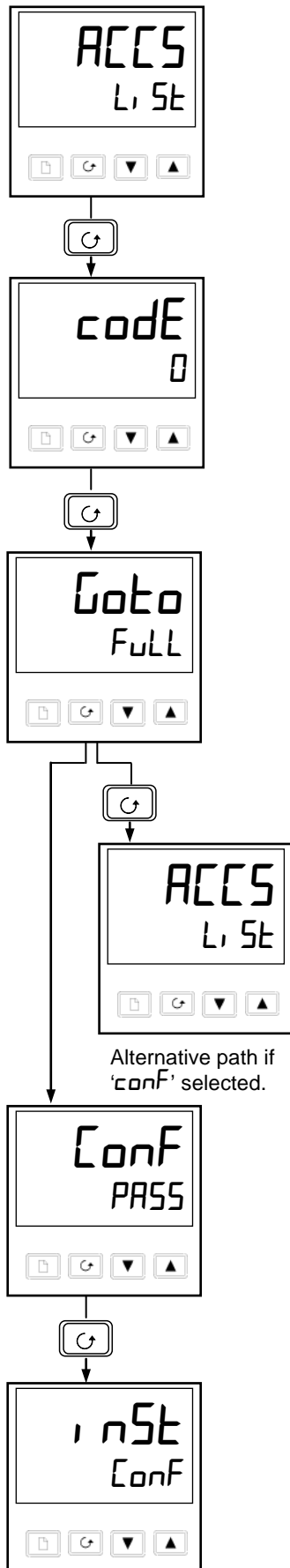

#### Access List Header

Press until you reach the access list header 'ACCS'.

Press

#### Password entry

The password is entered from the 'code' display.

Enter the password using or . Once the correct password has been entered, there is a two second delay after which the lower readout will change to show 'PASS' indicating that access is now unlocked.

The pass number is set to '1' when the controller is shipped from the factory.

(A special case exists if the password has been set to '0'. In this case access will be permanently unlocked and the lower readout will always show 'PASS').

Press to proceed to the 'Goto' page.

(If an *incorrect* password has been entered and the controller is still 'locked' then pressing returns you to the 'ACCS' list header.)

#### Level selection

The 'Goto' display allows you to select the required access level.

Use and to select from the following display codes:

- OPER: Operator level
- FULL: Full level
- Edit: Edit level
- CONF: Configuration level

#### Access to Read-only configuration

From the 'ACCS' list display, press to 'code'. Then press and together will take you into Read-Only Configuration without entering a password. This will allow you to view all of the configuration parameters, but not adjust them. If no button is pressed for ten seconds, you will be returned to the Home display. Alternatively, pressing and together takes you immediately back to the Home display.

Press

If you selected either 'OPER', 'FULL' or 'Edit' level you will be returned to the 'ACCS' list header in the level that you chose. If you selected 'CONF', you will get a display showing 'CONF' in the upper readout (see below).

#### Configuration password

When the 'CONF' display appears, you must enter the Configuration password in order to gain access to this level. Do this by repeating the password entry procedure described in the previous section.

The configuration password is set to '2' when the controller is shipped from the factory. If you need to change the configuration password, see Chapter 6, *Configuration*.

Press

#### Configuration level



The first display of configuration is shown. See Chapter 6, *Configuration*, for details of the configuration parameters.

### 3.3 EDIT LEVEL

Edit level is used to set which parameters you can view and adjust in Operator level. It also gives access to the 'Promote' feature, which allows you to select and add ('Promote') up to twelve parameters into the Home display list, thereby giving simple access to commonly used parameters.

#### 3.3.1 Setting operator access to a parameter

First you must select **Edi t** level, as shown on the previous page.

Once in **Edi t** level, you select a list, or a parameter within a list, in the same way as you would in Operator, or Full, level – that is to say, you move from list header to list header by pressing , and from parameter to parameter within each list using .

**However, in Edit level what is displayed is not the value of a selected parameter, but a code representing that parameter's availability in Operator level.**

When you have selected the required parameter, use  and  buttons to set its availability in Operator level.

There are four codes:

- **ALtEr** Makes a parameter alterable in Operator level.
- **PrO** Promotes a parameter into the Home display list.
- **rEAd** Makes a parameter, or list header, read-only (*it can be viewed but not altered*).
- **Hi dE** Hides a parameter, or list header.

For example:

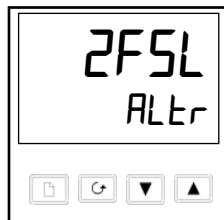

The parameter selected is Alarm 2, Full Scale Low

It will be alterable in Operator level

#### 3.3.2 Hiding or revealing a complete list

To hide a complete list of parameters, all you have to do is hide the list header. If a list header is selected, only two selections are available: **rEAd** and **Hi dE**.

(It is not possible to hide the **'ALCS'** list, which always displays the code: **'L, St'**.)

#### 3.3.3 Promoting a parameter

Scroll through the lists to the required parameter and choose the **'PrO'** code. The parameter is then automatically added (promoted) into the Home display list. (The parameter will also be accessible, as normal, from the standard lists.) A maximum of twelve parameters can be promoted. Promoted parameters are automatically 'alterable'.

Please note, in the **'PrOGL St'**, the parameters from segment number (**SEGN**) onwards *cannot* be promoted.

#### 3.3.4 Returning to Operator Level

To return to operator level from either **'FULL'** or **'Edi t'** level, repeat entry of the password and select **'OPER'** on the **'GoTo'** display.

In **'Edi t'** level, the controller will automatically return to operator level if no button is pressed for 45 seconds.

## 4. Chapter 4 TUNING

Before tuning please read Chapter 2, *Operation*, to learn how to select and change a parameter.

This chapter has five main topics:

- WHAT IS TUNING?
- AUTOMATIC TUNING
- MANUAL TUNING
- COMMISSIONING OF MOTORISED VALVE CONTROLLERS
- GAIN SCHEDULING

### 4.1 WHAT IS TUNING?

In tuning, you match the characteristics of the controller to that of the process being controlled in order to obtain good control. Good control means:

- Stable 'straight-line' control of the temperature at setpoint without fluctuation
- No overshoot, or undershoot, of the temperature setpoint
- Quick response to deviations from the setpoint caused by external disturbances, thereby restoring the temperature rapidly to the setpoint value.

Tuning involves calculating and setting the value of the parameters listed in Table 4-1. These parameters appear in the '*P, d*' list.

Parameter	Code	Meaning or Function
Proportional band	$Pb$	The bandwidth, in display units, over which the output power is proportioned between minimum and maximum.
Integral time	$t_i$	Determines the time taken by the controller to remove steady-state error signals.
Derivative time	$t_d$	Determines how strongly the controller will react to the rate-of-change of the measured value.
High Cutback	$Hcb$	The number of display units, above setpoint, at which the controller will increase the output power, in order to prevent undershoot on cool down.
Low cutback	$Lcb$	The number of display units, below setpoint, at which the controller will cutback the output power, in order to prevent overshoot on heat up.
Relative cool gain	$rEL$	Only present if cooling has been configured and a module is fitted. Sets the cooling proportional band, which equals the $Pb$ value divided by the $rEL$ value.

Table 4-1: Tuning parameters

## 4.2 AUTOMATIC TUNING

Two automatic tuning procedures are provided in the 2416:

- **A one-shot tuner** which automatically sets up the initial values of the parameters listed in Table 4-1 on the previous page.
- **Adaptive tuning** which continuously monitors the error from setpoint and modifies the PID values if necessary.

### 4.2.1 One-shot Tuning

The 'one-shot' tuner works by switching the output on and off to induce an oscillation in the measured value. From the amplitude and period of the oscillation, it calculates the tuning parameter values.

If the process cannot tolerate full heating or cooling being applied during tuning, then the level of heating or cooling can be restricted by setting the heating and cooling power limits in the 'OP' list. However, the measured value *must* oscillate to some degree for the tuner to be able to calculate values.

A One-shot Tune can be performed at any time, but normally it is performed only once during the initial commissioning of the process. However, if the process under control subsequently becomes unstable (because its characteristics have changed), you can re-tune again for the new conditions.

It is best to start tuning with the process at ambient temperature. This allows the tuner to calculate more accurately the low cutback and high cutback values which restrict the amount of overshoot, or undershoot.

### 4.2.2 How to tune

1. Set the setpoint to the value at which you will normally operate the process.
2. In the 'Auto' list, select 'TUNE' and set it to 'ON'.
3. Press the Page and Scroll buttons together to return to the Home display. The display will flash 'TUNE' to indicate that tuning is in progress.
4. The controller induces an oscillation in the temperature by first turning the heating on, and then off. The first cycle is not complete until the measured value has reached the required setpoint.
5. After two cycles of oscillation the tuning is completed and the tuner switches itself off.
6. The controller then calculates the tuning parameters listed in Table 4-1 and resumes normal control action.

If you want 'Proportional only', 'PD', or 'PI' control, you should set the 'P', 'I' or 'D' parameters to **OFF** before commencing the tuning cycle. The tuner will leave them off and will not calculate a value for them.

### 4.2.3 Typical automatic tuning cycle

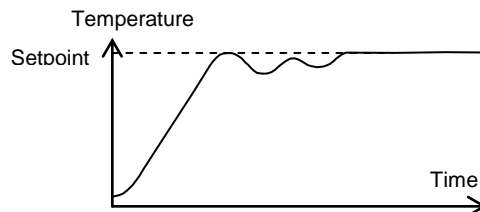

### 4.2.4 Calculation of the cutback values

*Low cutback* and *High cutback* are values that restrict the amount of overshoot or undershoot that occurs during large step changes in temperature (for example, under start-up conditions).

If either low cutback, or high cutback, is set to 'Auto' the values are fixed at three times the proportional band, and are not changed during automatic tuning.

### 4.2.5 Adaptive tune

Adaptive tuning is a background algorithm, which continuously monitors the error from setpoint and analyses the control response during process disturbances. If the algorithm recognises an oscillatory, or under-damped, response it recalculates the  $P_b$ ,  $I_t$  and  $D_d$  values.

Adaptive tune is triggered whenever the error from setpoint exceeds a trigger level. This trigger level is set in the parameter 'dRTE', which is found in the Autotune list. The value is in display units. It is automatically set by the controller, but can also be manually re-adjusted.

*Adaptive tune should be used with:*

1. Processes whose characteristics change as a result of changes in the load, or setpoint.
2. Processes that cannot tolerate the oscillation induced by a One-shot tune.

*Adaptive tune should not be used:*

1. Where the process is subjected to regular external disturbances that could mislead the adaptive tuner.
2. On highly interactive multiloop applications. However, moderately interactive loops, such as multi-zone extruders, should not give a problem.



### 4.3 MANUAL TUNING

If for any reason automatic tuning gives unsatisfactory results, you can tune the controller manually. There are a number of standard methods for manual tuning. The one described here is the Ziegler-Nichols method.

With the process at its normal running temperature:

1. Set the Integral Time ' $t_i$ ' and the Derivative Time ' $t_d$ ' to *OFF*.
2. Set High Cutback and Low Cutback, ' $H_{cb}$ ' and ' $L_{cb}$ ', to *Auto*.
3. Ignore the fact that the temperature may not settle precisely at the setpoint.
4. If the temperature is stable, reduce the proportional band ' $P_b$ ' so that the temperature just starts to oscillate. If the temperature is already oscillating, increase the proportional band until it just stops oscillating. Allow enough time between each adjustment for the loop to stabilise. Make a note of the proportional band value ' $B$ ' and the period of oscillation ' $T$ '.
5. Set the  $P_b$ ,  $t_i$  and  $t_d$  parameter values according to the calculations given in Table 4-2.

Type of control	Proportional band ' $P_b$ '	Integral time ' $t_i$ '	Derivative time ' $t_d$ '
Proportional only	2xB	OFF	OFF
P + I control	2.2xB	0.8xT	OFF
P + I + D control	1.7xB	0.5xT	0.12xT

Table 4-2: Tuning values

#### 4.3.1 Setting the cutback values

The above procedure sets up the parameters for optimum steady state control. If unacceptable levels of overshoot or undershoot occur during start-up, or for large step changes in temperature, then manually set the cutback parameters ' $L_{cb}$ ' and ' $H_{cb}$ '.

**Proceed as follows:**

1. Set the low and high cutback values to three proportional bandwidths (that is to say,  $L_{cb} = H_{cb} = 3 \times P_b$ ).
2. Note the level of overshoot, or undershoot, that occurs for large temperature changes (see the diagrams below).

In example (a) increase ' $L_{cb}$ ' by the overshoot value. In example (b) reduce ' $L_{cb}$ ' by the undershoot value.

**Example (a)**

**Example (b)**

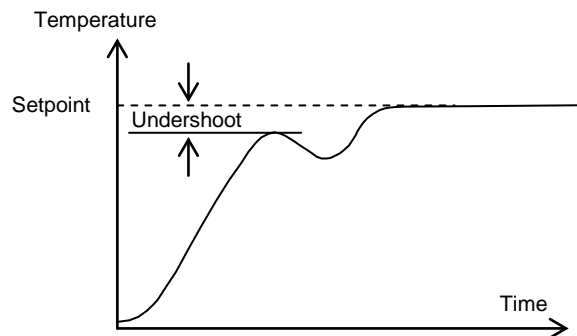
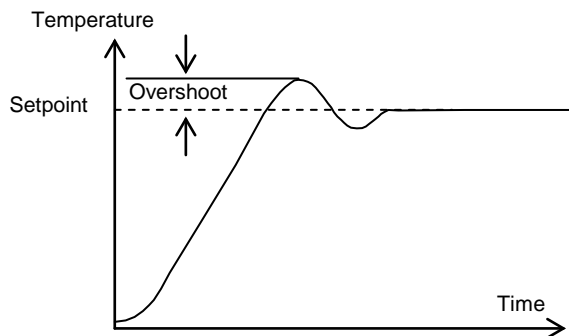

Where the temperature approaches setpoint from above, you can set ' $H_{cb}$ ' in a similar manner.

### 4.3.2 Integral action and manual reset

In a full three-term controller (that is, a PID controller), the integral term '**I**' automatically removes steady state errors from the setpoint. If the controller is set up to work in two-term mode (that is, PD mode), the integral term will be set to '**OFF**'. Under these conditions the measured value may not settle precisely at setpoint. When the integral term is set to '**OFF**' the parameter *manual reset* (code '**RES**') appears in the '**PID SET**' in '**FULL**' level. This parameter represents the value of the power output that will be delivered when the error is zero. You must set this value manually in order to remove the steady state error.

### 4.3.3 Automatic droop compensation (Adc)

The steady state error from the setpoint, which occurs when the integral term is set to '**OFF**' is sometimes referred to as 'droop'. '**Adc**' automatically calculates the manual reset value in order to remove this droop. To use this facility, you must first allow the temperature to stabilise. Then, in the autotune parameter list, you must set '**Adc**' to '**ALC**'. The controller will then calculate a new value for manual reset, and switch '**Adc**' to '**MAN**'.

'**Adc**' can be repeated as often as you require, but between each adjustment you must allow time for the temperature to stabilise.

### 4.3.4 Tune Error

If any one stage of the automatic tuning process is not completed within two hours a diagnostic alarm will occur. The display shows **TUEr** - Tune Error.

This alarm could occur if:

1. The process to be tuned has a very slow response time
2. The sensor has failed or is incorrectly aligned
3. The loop is broken or not responding correctly

### 4.4 MOTORISED VALVE CONTROL

The 2416 can be configured for motorised valve control as an alternative to the standard PID control algorithm. This algorithm is designed specifically for positioning motorised valves.

These are ordered, pre-configured, as Model numbers:

- 2416/VC motorised valve controllers
- 2416/VP motorised valve controllers with a single setpoint programmer
- 2416/V4 motorised valve controllers storing four setpoint programs.

Figure 1-8 in Chapter 1 shows how to connect a motorised valve controller. The control is performed by delivering open, or close, pulses in response to the control demand signal.

The motorised valve algorithm operates in the so-called *boundless* mode, which does not require a position feedback potentiometer for control purposes.

The desired control mode is selected in the 'nSt' list in configuration level.

The following parameter list will appear in the navigation diagram shown in Chapter 2, if your controller is configured for motorised valve control.

Name	Description	Values		
		Min	Max	Default
<i>mtr</i>	<b>Motor list</b>			
<i>tm</i>	Valve travel time in seconds. This is the time taken for the valve to travel from its fully closed position to its fully open position.	0.1	240.0	30.0
<i>int</i>	Valve inertia time in seconds. This is the time taken for the valve to stop moving after the output pulse is switched off.	OFF	20.0	OFF
<i>brct</i>	Valve backlash time in seconds. This is the minimum on-time required to reverse the direction of the valve. i.e. the time to overcome the mechanical backlash.	OFF	20.0	OFF
<i>mpt</i>	Output pulse minimum on-time, in seconds.	Auto	100.0	Auto
<i>ubr</i>	Valve sensor break strategy.	rEst, uP, dwn		rEst

Table 4-3: Motorised valve parameter list

#### 4.4.1 Commissioning the Motorised Valve Controller

The commissioning procedure for bounded control mode is as follows:

1. Measure the time taken for the valve to be raised from its fully closed to its fully open position and enter this as the value in seconds into the 'tm' parameter.
2. Set all the other parameters to the default values shown in Table 4-3.

The controller can then be tuned using any of the automatic, or manual, tuning procedures described earlier in this chapter. As before, the tuning process, either automatic or manual, involves setting the values of the parameters in Table 4-1.

#### 4.4.2 Adjusting the minimum on-time 'mPL'

The default value of 0.2 seconds is satisfactory for most processes. If, however, after tuning the process, the valve activity is excessively high, with constant oscillation between raise and lower pulses, the minimum on-time can be increased.

The minimum on-time determines how accurately the valve can be positioned and therefore the control accuracy. The shorter the time, the more precise the control. However, if the time is set too short, process noise will cause an excessively busy valve.

#### 4.4.3 Inertia and backlash settings

The default values are satisfactory for most processes, i.e. 'OFF'.

**Inertia** is the time taken for the valve to stop after the output pulse is turned off. If this causes a control problem, the inertia time needs to be determined and then entered into the parameter, 'In'. The inertia time is subtracted from the raise and lower output pulse times, so that the valve moves the correct distance for each pulse.

**Backlash** is the output pulse time required to reverse the direction of the valve, i.e. the time taken to overcome the mechanical backlash of the linkages. If the backlash is sufficient to cause a control problem, then the backlash time needs to be determined and then entered into the parameter, 'bAcL'.

The above two values are not part of the automatic tuning procedure and must be entered manually.

## 4.5 GAIN SCHEDULING

Gain scheduling is the automatic transfer of control between one set of PID values and another. In the case of the 2416 controller, this is done at a presettable process value. It is used for the more difficult to control processes which exhibit large changes in their response time or sensitivity at, for example, high and low temperatures, or when heating or cooling.

The 2416 has two sets of PID values. You can select the active set from either a parameter in the PID list, or you can transfer automatically in gain scheduling mode. The transfer is bumpless and will not disturb the process being controlled.

To use gain scheduling, follow the steps below:



### Step 1: Enable in configuration level

Gain scheduling must first be enabled in Configuration level. Goto the *Inst Conf* list, select the parameter *GSch*, and set it to *YES*.

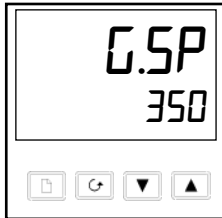

### Step 2: Set the transfer point

Once gain scheduling has been enabled, the parameter *G.SP* will appear at the top of the *PID* list in *FULL* access level. This sets the value at which transfer occurs. *PID1* will be active when the process value is below this setting and *PID2* when the process value is above it. The best point of transfer depends on the characteristics of the process. Set a value between the control regions that exhibit the greatest change.

### Step 3: Tuning

You must now set up the two sets of PID values. The values can be manually set, or automatically tuned as described earlier in this chapter. When tuning automatically you must tune twice, once above the switching point *G.SP* and again below the switching point. When tuning, if the process value is below the transfer point *G.SP* the calculated values will automatically be inserted into *PID1* set and if the process value is above *G.SP*, the calculated values will automatically be inserted into *PID2* set.

## 5. Chapter 5 PROGRAMMER OPERATION

This chapter deals with the setpoint programming option. All 2416 instruments have a basic 8-segment programmer built-in as standard. This facility must be enabled by the user, as explained in section 5.6, *Configuring the Programmer*.

Other programmer versions are listed below, and have 16-segments in each program.

Standard controller with:

a single program: Model 2416/CP.

four stored programs: Model 2416/P4.

Motorised valve controller with:

a single program: Model 2416/VP.

four stored programs: Model 2416/V4.

The 8-segment programmer differs from the other programmers in that it will not provide event outputs. Otherwise they all operate in the same way.

There are seven topics:

- WHAT IS SETPOINT PROGRAMMING?
- PROGRAMMER STATES
- RUNNING A PROGRAM FROM THE RUN LIST
- RUNNING A PROGRAM USING THE RUN/HOLD BUTTON
- AUTOMATIC BEHAVIOUR
- CONFIGURING THE PROGRAMMER
- CREATING A NEW PROGRAM, OR MODIFYING AN EXISTING PROGRAM.

To understand how to select and change parameters in this chapter you will need to have read Chapter 2, *Operation* and Chapter 3, *Access Levels*.

### 5.1 What Is Setpoint Programming?

Many applications need to vary temperature, or process value, with time. Such applications need a controller which varies a setpoint as a function of time. All 2416 programmer models will do this.

The setpoint is varied by using a *setpoint program*. Within each 2416 controller there is a software module, called *the programmer*, which stores one, or more, such programs and drives the setpoint according to the selected program. The program is stored as a series of 'ramp' and 'dwell' segments, as shown below.

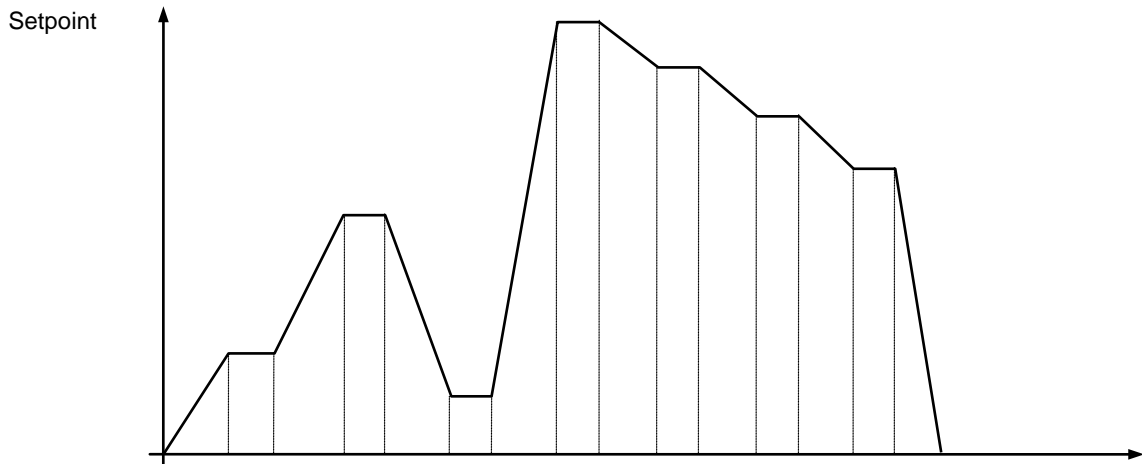

Figure 5-1: Setpoint profile

(If the 8-segment programmer is being used, then the information in the next paragraph does **not** apply.)

In each segment you can define the state of up to two outputs, each of which can be used to trigger external events. These are called *event outputs* and can drive either relay, logic, or triac outputs, depending on the modules installed.

A program is executed either, once, repeated a set number of times, or repeated continuously. If repeated a set number of times, then the number of cycles must be specified as part of the program.

There are five different types of segment:



<b>Ramp</b>		<b>The setpoint ramps linearly</b> , from its current value to a new value, either at a set rate (called <i>ramp-rate programming</i> ), or in a set time (called <i>time-to-target programming</i> ). You must specify the ramp rate, or the ramp time, and the target setpoint, when creating or modifying a program.
<b>Dwell</b>		<b>The setpoint remains constant</b> for a specified period.
<b>Step</b>		<b>The setpoint steps instantaneously</b> from its current value to a new value.
<b>Call</b>		<b>The main program calls another program as a subroutine.</b> The called program then drives the setpoint until it returns control to the main program. This facility is only available on those controllers capable of storing 4 programs.
<b>End</b>		<b>A program either ends in this segment, or repeats.</b> You specify which is the case when you create, or modify, a program (see the final topic in this chapter). When a program ends, the programmer is put into either, a continuous Dwell state with all outputs staying unchanged, or the Reset state.

Table 5-1: Segment types

## 5.2 Programmer States

Programs has five states:– *Reset, Run, Hold, Holdback* and *End*.

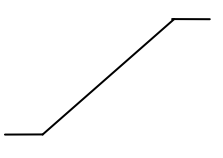
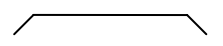
State	Description	Indication
<b>Reset</b>	In Reset, the programmer is inactive and the controller behaves as a standard controller, with the setpoint determined by the value set in the lower readout.	<b>Both the RUN and HOLD lights will be off</b>
<b>Run</b>	In Run, the programmer varies the setpoint according to the active program.	<b>RUN light on</b>
<b>Hold</b>	In Hold, the program is frozen at its current point. In this state you can make temporary changes to any program parameter (for example, a target setpoint, a dwell time, or the time remaining in the current segment). <b>Such changes only remain effective until the program is reset and run again, when they are overwritten by the stored program values.</b>  <b>Note:</b> When a program is running, you <u>cannot</u> alter a <b>CALLed</b> program until it becomes active within that program.	<b>HOLD light on</b>
<b>Holdback</b>	Holdback indicates that the measured value is deviating from the setpoint by more than a pre-set amount and that the program is in Hold, waiting for the process to catch up. See <i>Holdback</i> in the section on Automatic behaviour later this Chapter.	<b>HOLD light flashes</b>
	A master controller can re-transmit a setpoint value to a number of slave units using PDSIO setpoint retransmission. Any of the slave units can generate a holdback signal which will also flash the <b>HOLD</b> light. Holdback will also occur if the PDSIO output is open circuit. This can be disabled in configuration by selecting the <b>PdS</b> output as <b>SPnH</b> - 'setpoint retransmission without holdback'	<b>HOLD light flashes</b>
<b>End</b>	The program is complete.	<b>RUN light flashes</b>

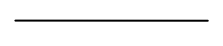
Table 5-2: Program states



### 5.3 Running A Program From The Run List

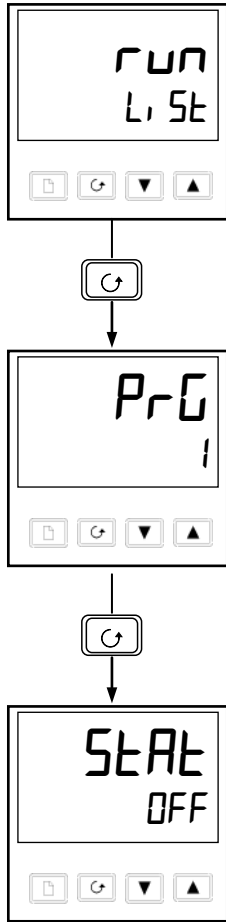

#### The Run List

From the Home display, press until you reach the 'run' list header.

Press

#### Program number

This display will only appear on controllers that can hold more than one program (Models 2416/P4 & 2416/V4). Use or to select the required program number, from 1 to 4.

Press

#### Status selection

Use or to select:

- **run** Run program.
- **hold** Hold program.
- **OFF** Program reset.

After two seconds, the lower readout blinks and the chosen state is now active.

To return to the Home display press and together.

#### Other parameters

To access the other parameters in the 'run' list, continue to press . These parameters are shown in the 'Program run list' in Chapter 2, Parameter Tables. They show the current status of the active program.

#### Temporary changes

Temporary changes can be made to the parameters in this 'run' list, (for example a setpoint, ramp rate, or an unelapsed time), by first placing the programmer into 'hold'. Such changes will remain active only for the duration of the segment; the segment parameters will revert to their original (stored) values whenever the segment is re-executed.

## 5.4 Running A Program Using The Run/Hold Button

If you are using a four (4) program version of the controller, you must first select the number of the program that you want to run. Do this in the 'run' list - see the previous topic, *Running a program from the Run list*.

Then:

	<p>RUN / HOLD button</p>	<p>Press once to run a program (RUN light on)</p> <p>Press again to hold a program (HOLD light on)</p> <p>Press again to cancel hold and continue running (HOLD light off, RUN light on)</p> <p>Press and hold in for two seconds to reset a program (RUN and HOLD lights off).</p>
---	------------------------------	---



**Note:**

The RUN/HOLD button can be disabled, either when ordering the controller, or subsequently in configuration. This will force you to operate the programmer from the 'run' list all the time. The main advantage of this method is that it will reduce the chance of accidentally changing the state of a program.

## 5.5 Automatic Behaviour

The preceding topics explain how to operate the programmer manually.

The following topics cover aspects of its automatic behaviour: *Servo*, *Holdback* and *Power Failure*.

### 5.5.1 Servo

When a program is RUN, the setpoint can start either from the initial controller setpoint, or from the process value. Whichever it is, the starting point is called the 'servo' point and you set it up in configuration. When the program starts, the transition of the setpoint to its starting point is called 'servoing'.

The normal method is to servo to the process value, because this will produce a smooth and bumpless start to the program. However, if you want to guarantee the time period of the first segment, you should set the controller to servo to its setpoint.

### 5.5.2 Holdback

As the setpoint ramps up, or down (or dwells), the measured value may lag behind, or deviate from, the setpoint by an undesirable amount. 'Holdback' is available to freeze the program at its current state, should this occur. The action of Holdback is the same as a deviation alarm. It can be enabled, or disabled. Holdback has **two** parameters - a *value* and a *type*.

If the error from the setpoint exceeds the set 'holdback' value, then the Holdback feature, if enabled, will automatically freeze the program at its current point and flash the HOLD light. When the error comes within the holdback value, the program will resume normal running.

There are *four* different Holdback types. The choice of type is made by setting a parameter when creating a program, and may be one of the following:-

'OFF' – **Disables Holdback** – therefore no action is taken.

'Lo' – **Deviation Low Holdback** holds the program back when the process variable deviates *below* the setpoint by more than the holdback value.

'Hi' – **Deviation High Holdback** holds the program back when the process variable deviates *above* the setpoint by more than the holdback value.

'band' – **Deviation Band Holdback** is a combination of the two. It holds the program back when the process variable deviates *either above, or below*, the setpoint by more than the holdback value.

There is a single Holdback Value which applies to the whole program. However, the Holdback type and whether or not it is enabled, can be applied to the program as a whole, or individually in each segment.

### 5.5.3 Power failure

If power is lost and then restored, while a program is running, the behaviour of the programmer is determined by the setting of the parameter '*PwrF*' *Power fail strategy* in Programmer configuration. This can have one of three settings: - *cont* (Continue), *rmb* (Ramp from PV), or *rset* (Reset).

**If '*cont*' is selected,** then when power is restored the program continues from where it was interrupted when power was lost. All parameters, such as the setpoint and time remaining in the active segment, will be restored to their power-down values. For applications that need to bring the measured process value to the setpoint as soon as possible, this is the best strategy.

**If '*rmb*' is selected,** then when power is restored the setpoint starts at ('servos to') the current measured value, and then ramps to the target setpoint of the active segment at the last ramp rate used by the program. This strategy provides a smoother recovery. The two diagrams below illustrate the respective responses, Figure 5-2 if power fails during a dwell segment and Figure 5-3 if it fails during a ramp segment.

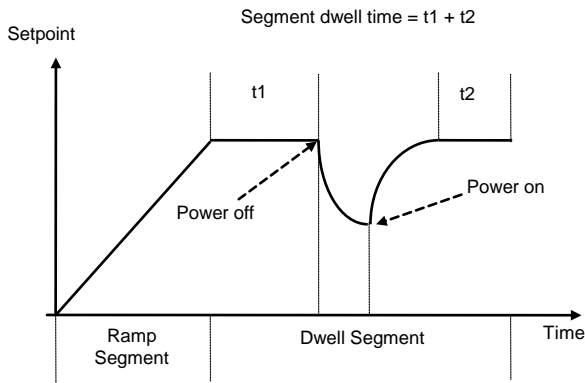

Figure 5-2: Continue after a power fail

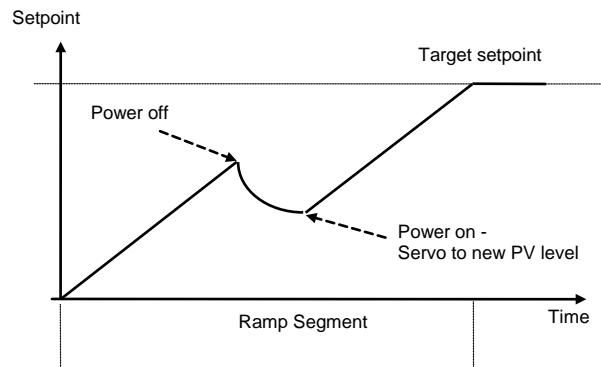

Figure 5-3: Ramp back after a power fail

**If '*rset*' is selected,** then when power is restored the program terminates.

## 5.6 Configuring The Programmer

Configuration defines:

- the number of stored programs (*Multi programmer only*)
- the holdback strategy
- the power fail strategy
- the servo type
- if event outputs are available. (*Multi programmer only*)

When first installing a programmer, you should check that the configuration conforms to your requirement.

**To check or change** the configuration, select Configuration level. See Chapter 6.

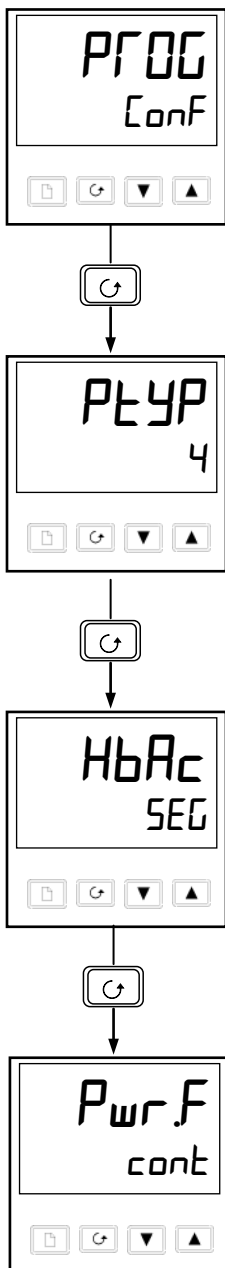

### Programmer list header

After selecting Configuration mode, press  until the *PROG Conf* header is displayed.

Press 

### Number of programs

Use  or  to select:

- *nonE*: Disable built-in 8-segment programmer
- *I*: Enable built-in 8-segment programmer

For 16-segment programmers:

- *nonE*: no programs
- *I*: One stored program
- *4*: Four stored programs

Press 

### Holdback Strategy

Use  or  to select:

- *SEG*: Holdback type to be set in each segment
- *PrAc*: Holdback type to be set for the whole program

Press 

### Power fail strategy

Use  or  to select:

- *cont*: Continue from last setpoint
- *rmpb*: Ramp from PV to setpoint at last ramp rate
- *rSEt*: Reset the program

*Continued on next page*

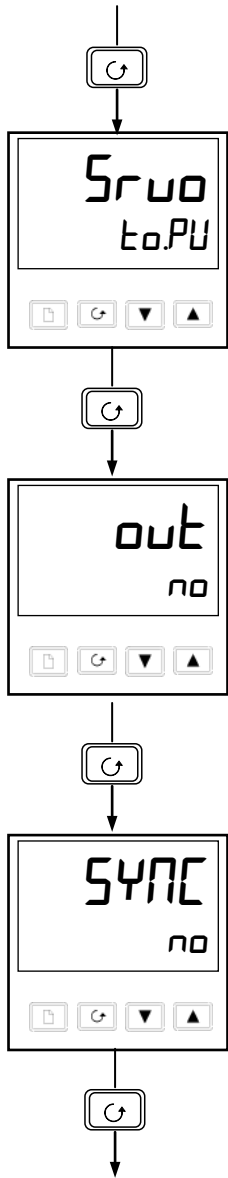

Press 

**Servo type**

Use  or  to select:

- to.PU Servo to PV
- to.SP Servo to SP

Press 

**Event Outputs (not in 8-segment programmer)**

Use  or  to select:

- no: Event outputs disabled
- YES: Event outputs enabled

Note: The term Sync appears on 2416 but is not operational and should be set to no. It appears in order to maintain software consistency with 2408 and 2404 controllers.

Press  to return to the list header

**5.6.1 Creating a New Program or Modifying an Existing One**

The only difference between creating a new program and modifying an existing one, is that a new program starts with all its segments set to 'End' in the 'TYPE' parameter. The procedure for both consists of setting up the parameters in the 'Prog' list of the Operation Navigation Diagram shown in Chapter 2. As explained earlier, under 'Programmer States', temporary changes can be made to these parameters while in the HOLD state, but permanent changes (to the stored values) can only be made when the programmer is in the Reset state. So, before modifying a stored program first make sure that it is in Reset and then follow the procedure below:

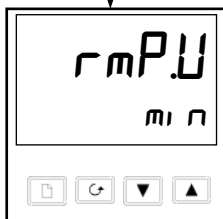
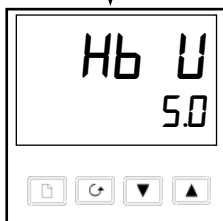
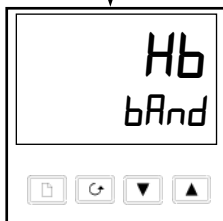
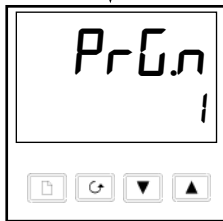
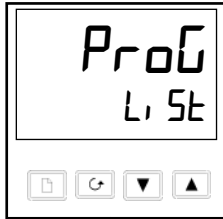

**Program edit list**

From the Home display press until you reach the 'Prog List' header.

Press

**Program number**

This display only appears on the four-program controllers.

Use or to select the number of the program which you wish to modify (from 1 to 4).

Press

**Holdback type**

[Only appears when Holdback has been selected for the whole program.]

Use or to select:

- OFF Holdback disabled
- L<sub>a</sub> Deviation Low Holdback
- H<sub>i</sub> Deviation High Holdback.
- b<sub>And</sub> Deviation Band Holdback

Press

**Holdback value**

Use or to set a value.

Press

**Ramp units**

Use or to select:

- 5E<sub>c</sub>
- m<sub>i</sub> n
- Hour

*Continued on the next page.*

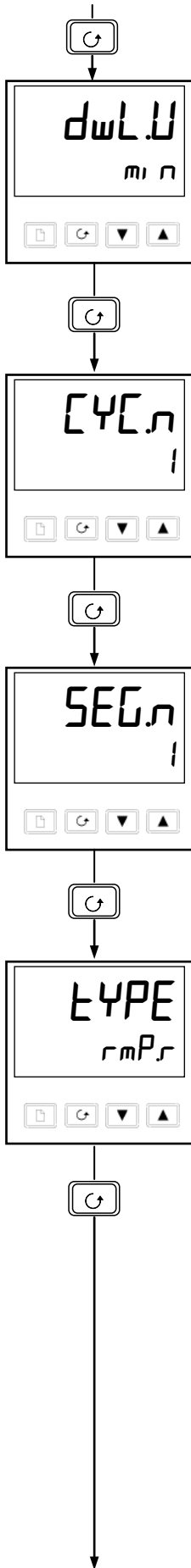

Press

**Dwell units**

Use or to select:

- SEc
- mi n
- Hour

Press

**Number of program cycles**

Use or to set the number of program cycles required from 1 to 999, or 'cont' for continuous cycling.

Press

**Segment number**

Use or to select the number, [1 to 8 (8-seg programmer)], or 1 to 16.

The parameters that follow 'SEG.n' set up the characteristics of the individually-selected segment number. By defining the characteristics of each segment of the program, you define the whole program.

Press

**Segment type**

Select the segment type using or .

- rmpR Ramp to a new setpoint at a set rate
- rmpE Ramp to a new setpoint in a set time
- dwEII Dwell for a set time
- StEP Step to a new setpoint
- cALL Call another program as a subroutine (only available in 4-program controllers)
- End Make this segment end of program.

Press

The parameters that follow 'TYPE' depend on the type of segment selected.

Parameter	Segment type selected					
	rmpR	rmpE	dwEII	StEP	cALL	End
Hb	✓	✓	✓	✓		
tGt	✓	✓		✓		
rAtE	✓					
dur		✓	✓			
PrGn					✓	
outn	✓	✓	✓	✓		✓
cYcn					✓	
dwEII						✓
EndE						✓
Pwr						✓

Continued on next page

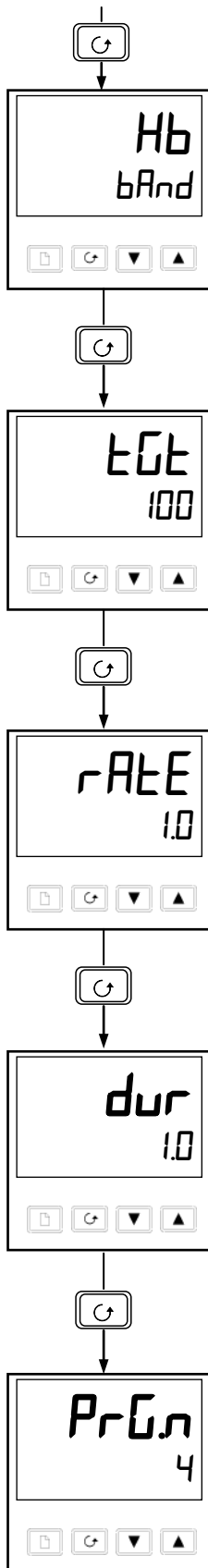

Press

**Holdback type**

[Only appears when Holdback per segment has been selected.]

Use or to select:

- OFF: Holdback disabled
- Lo: Deviation Low Holdback
- Hi : Deviation High Holdback
- bAnd: Deviation Band Holdback

Press

**Target setpoint**

Target setpoint for 'rmpL', 'rmpH' or 'STEP' segments.

Set the target setpoint using or .

Press

**Ramp Rate**

Ramp rate for 'rAtE' segments.

Using or , set a value for the ramp rate, ranging from 0.00 to 999.9 (the units will be the ramp units ('rmpU') set earlier in this sequence).

Press

**Duration time**

Time for a 'durE' segment, or time to target for a 'rmpH' segment.

Set the time using or . You have set the units earlier in this sequence.

Press

**Called program number**

Only appears for 'cALL' segments. (4-program controllers only)

Set a called program number from 1 to 4, using or .

*Continued on next page*



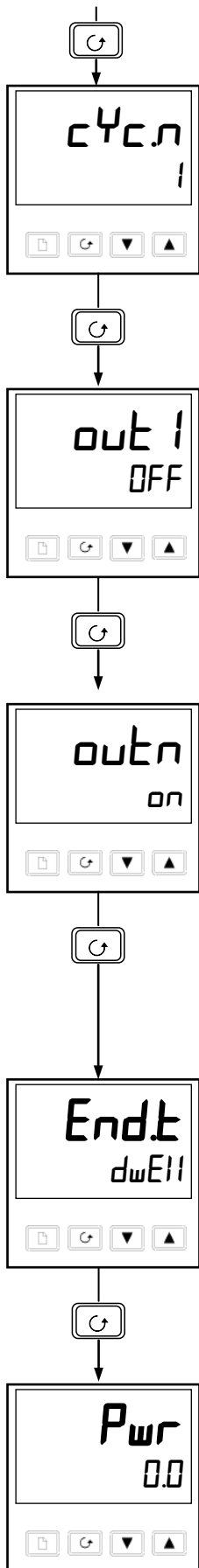

Press

**Number of cycles of the called program**

Only appears for 'cALL' segments. (4-program controllers only)

Set the number of cycles of the cALLed program from 1 to 999, using or .

Press

**Event output 1** (not 8-segment programmer)

Appears in all segments, except 'cALL' segments.

Use or to set output 1:

- OFF Off in the current segment
- on On the current segment.

Press

**Further event outputs** (not 8-segment programmer)

Up to eight (8) event outputs may appear in this list where 'n' = event number .

Pressing will step through all the remaining event outputs. **In practice**, the 2416 has a **maximum of three physical outputs**, although more than one event can be combined onto a single physical output. See Chapter 6, Configuration.

Use or to set:

- OFF Off in the current segment
- on On the current segment.

Press

**End segment type**

Use or to select:

- dwEll An indefinite dwell
- rSEt Reset
- SOP End Segment Output Power Level

Press

**Power Value** [End Segment]

Use or to set the power value in the range ±100.0%.

This power level is clipped by the parameters 'OP.H' and 'OP.L' before being applied to the process.

**In programmer/controller software versions 3.56 onwards, this parameter has been replaced by a parameter EndP which appears at the end of the output list, see Chapter 2.**

Press to return to the PRoG-LS header

## 6. Chapter 6 CONFIGURATION

This chapter consists of six topics:

- SELECTING CONFIGURATION LEVEL
- SELECTING A CONFIGURATION PARAMETER
- LEAVING CONFIGURATION LEVEL
- CHANGING THE PASSWORDS
- NAVIGATION DIAGRAM
- CONFIGURATION PARAMETER TABLES.

In configuration level you set up the fundamental characteristics of the controller.

These are:

- The type of control (e.g. reverse or direct acting)
- The Input type and range
- The Setpoint configuration
- The Alarms configuration
- The Programmer configuration
- The Communications configuration
- The Modules 1, 2 & 3 configuration
- Calibration
- The Passwords





**Warning:** Configuration is protected by a password and should only be carried out by a qualified person, authorised to do so. Incorrect configuration could result in damage to the process being controlled and/or personal injury. It is the responsibility of the person commissioning the process to ensure that the configuration is correct.



**Caution:** It is recommended to maintain a record of instrument configurations or use Eurotherm iTools to make clone copies of fully working instruments. Store this securely as a back up record to be used to restore the configuration and other settings should the instrument need to be replaced in the future. iTools and the iTools Help Manual HA028838 is available from [www.eurotherm.co.uk](http://www.eurotherm.co.uk).

### 6.1 Selecting Configuration Level

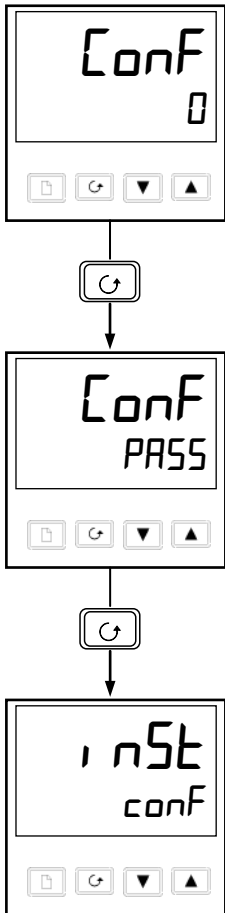

There are two alternative methods of selecting Configuration level:

- If you have already powered up, then follow the access instructions given in Chapter 3, *Access levels*.
- Alternatively, press  and  together when powering up the controller. This will take you directly to the 'CONF' password display.



#### Password entry

When the 'CONF' display appears, you must enter the Configuration password (which is a number) in order to gain access to Configuration level.

Enter the password using the  or  buttons.



The configuration password is set to '2' when the controller is shipped from the factory.

Press 

Once the correct password has been entered, there is a two second delay, after which the lower readout will change to 'PASS' indicating that access is now unlocked.

**Note:** Note: A special case exists if the password has been set to '0'. In this situation, access is permanently unlocked and the lower readout will always show 'PASS'.

Press  to enter configuration.

(If an incorrect password has been entered and the controller is still 'locked' then pressing  at this point will take you to the 'Err' display with 'no' in the lower readout. Simply press  to return to the 'CONF' display.)

You will obtain the first display of configuration.

## 6.2 Selecting a Configuration Parameter

The configuration parameters are arranged in lists as shown in the navigation diagram in Figure 6.5.



To step through the list headers, press the Page  button.

To step through the parameters within a particular list press the Scroll  button.

When you reach the end of the list you will return to the list header.

You can return directly to the list header at any time by pressing the Page  button.

### 6.2.1 Parameter names

Each box in the navigation diagram shows the display for a particular parameter. The upper readout shows the name of the parameter and the lower readout its value. For a definition of each parameter, see the Configuration Parameter Tables at the end of this chapter. To change the value of a selected parameter, use the  and  buttons.

The navigation diagram shows all the lists headers and parameters that can, potentially, be present in the controller. In practice, those actually present will vary according to the particular configuration choices you make.

## 6.3 Changing the Passwords

There are TWO passwords. These are stored in the Password configuration list and can be selected and changed in the same manner as any other configuration parameter.

The password names are:



- '*ALCP*' which protects access to Full level and Edit level
- '*cnFP*' which protects access to Configuration level.

## 6.4 Leaving Configuration Level

To leave the Configuration level and return to Operator level Press  until the 'E I t' display appears.

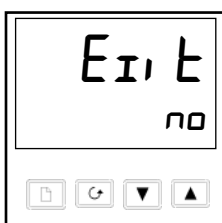
Alternatively, pressing  and  together will take you directly to the 'E I t' display.



Use  or  to select 'YES'. After a two-second delay, the display will blank then revert to the Home display in Operator level.

### 6.5 NAVIGATION DIAGRAM (PART A)

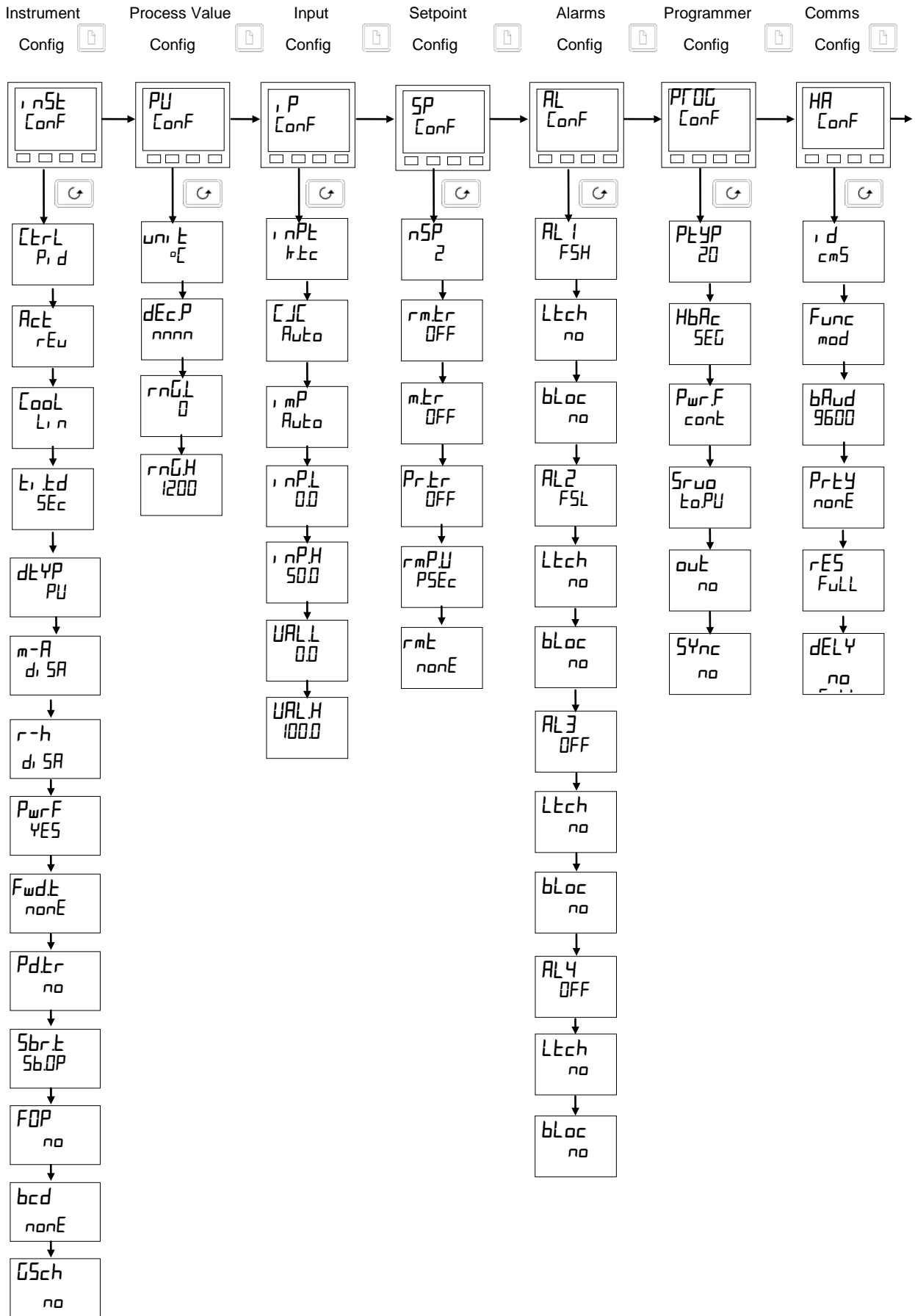
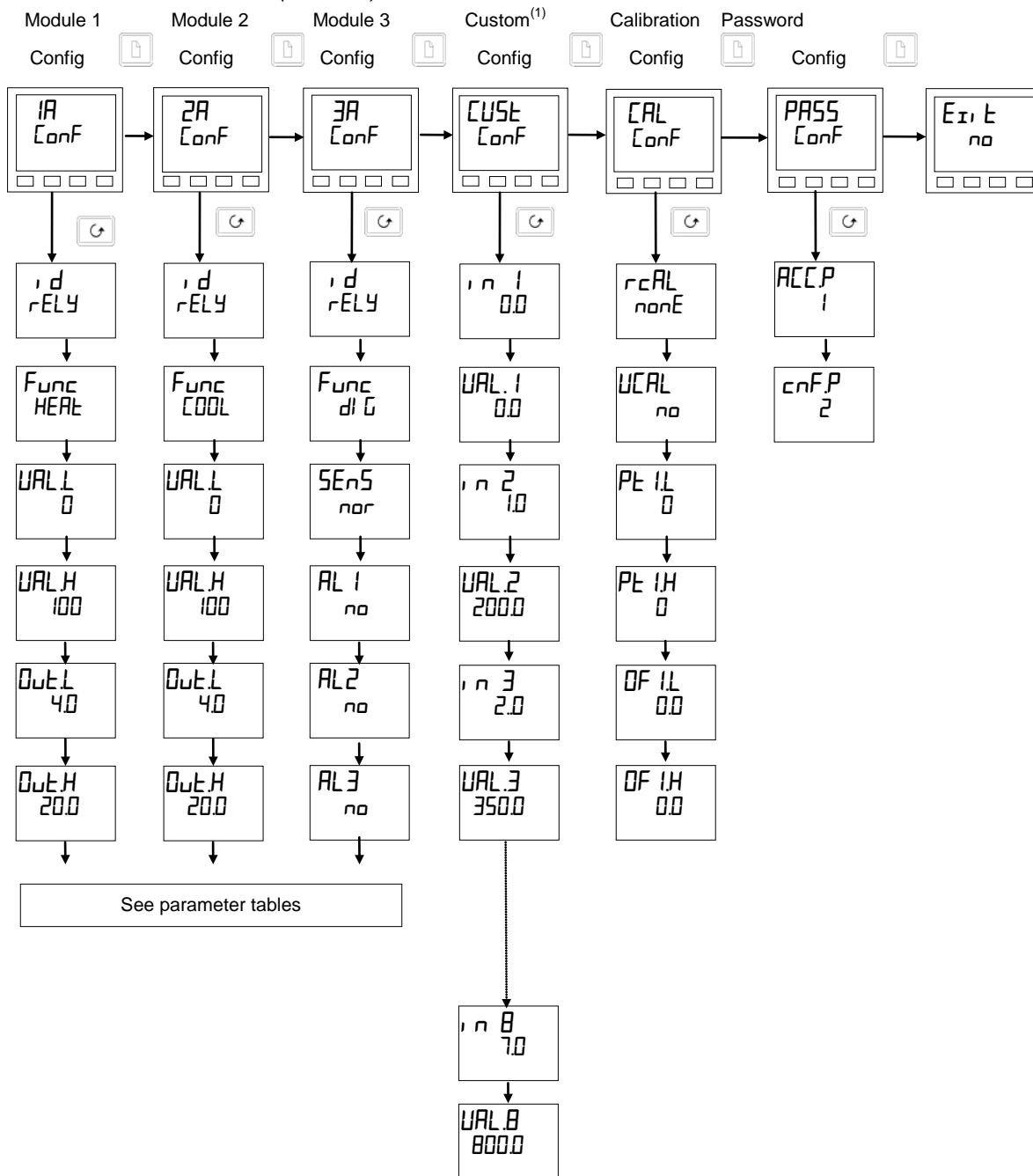

Figure 6-1: Navigation diagram (Part A)

**NAVIGATION DIAGRAM (PART B)**



**Note:**

- 8-point custom linearisation. Only appears when 'P-Conf' has 'nPt' = 'mUL', or 'mAL', or 'UL'.
- The navigation diagram shows typical parameters, but is dependant upon the exact configuration of the instrument. The following sheets show the full list of parameters.

Figure 6.1: Navigation diagram (Part B)

### 6.6 Configuration Parameter Tables

Name	Description	Values	Meaning
<b>Inst</b>	<b>Instrument configuration</b>		
<b>Ctrl</b>	Control type	<b>PID</b> <b>ONOFF</b>	PID control On/off control
<b>Act</b>	Control action	<b>UP</b> <b>REV</b> <b>DIR</b>	Boundless motorised valve control - <i>no feedback required</i> Reverse acting Direct acting
<b>Cool</b>	Type of cooling	<b>Lin</b> <b>Oil</b> <b>H2O</b> <b>FAN</b> <b>ONOFF</b>	Linear Oil (50mS minimum on-time) Water (non-linear) Fan (0.5S minimum on-time) On/off cooling
<b>Intd</b>	Integral & derivative time units	<b>SEC</b> <b>min</b>	Seconds, OFF to 9999 Minutes, OFF to 999.9
<b>dtYP</b>	Derivative type	<b>PV</b> <b>Err</b>	Operates on rate of change of PV Operates on rate of change of error
<b>m-A</b>	Front panel Auto/Man button	<b>EnAb</b> <b>diSA</b>	Enabled Disabled
<b>r-h</b>	Front panel Run/Hold button	<b>EnAb</b> <b>diSA</b>	Enabled Disabled
<b>PwrF</b>	Power feedback	<b>on</b> <b>OFF</b>	On Off
<b>Fwdt</b>	Feed forward type	<b>nonE</b> <b>FEEd</b> <b>SPFF</b> <b>PUFF</b>	None Normal feed forward Setpoint feed forward PV feed forward
<b>Pdtr</b>	Manual/Auto transfer when using PD control	<b>no</b> <b>YES</b>	Non-bumpless transfer Bumpless transfer - ( <i>Pre-loads Manual Reset value</i> )
<b>Sbrt</b>	Sensor break output	<b>SbOP</b> <b>HoLd</b>	Go to pre-set value Freeze output
<b>FOP</b>	Forced manual output	<b>no</b> <b>trAc</b>	Bumpless Auto/Manual transfer Returns to the Manual value that was set when last in Manual mode
		<b>STEP</b>	Steps to forced output level. Value set in 'FOP' of 'oP-Li St' in Operator Level
<b>bcd</b>	BCD input function	<b>nonE</b>	Not used
		<b>PrOG</b> <b>SP</b>	<i>Only functional in Models 2408 &amp; 2404. Set 'bcd' to 'nonE'</i> Select setpoint number
<b>Gsch</b>	Gain Schedule Enable	<b>no</b> <b>YES</b>	Disabled Enabled

Name	Description	Values	Meaning
<b>PU</b>	<b>Process value config</b>		
Unit	Instrument units	C F K none	Celsius Fahrenheit Kelvin Display units blanked
dECP	Decimal places in the displayed value	none one two	None One Two
rngL	Range low		Low range limit. Also setpoint limit for alarms and programmers
rngH	Range high		High range limit. Also setpoint limit for alarms and programmers

**Note:** **Pyrometer Emmisivity**

 Controllers which are specifically supplied for pyrometer inputs (not Exergen K80), have the curve downloaded in the Custom Input. The parameter, **Emi 5**, Pyrometer Emmisivity, appears in the Input List on page 2-15. This parameter is also now correctly adjusted

**Note:** **Range**

 If a decimal point was configured, negative display and setpoint ranges were limited to -99.9 in previous software versions. The range has been increased to -199.9 by combining the negative sign with the figure one. This allows Setpoints, Process Variables, Alarm Setpoints and Programmers to be set to -199.9.





Name	Description	Values	Meaning
<b>SP</b>	<b>Setpoint configuration</b>		
<i>nSP</i>	Number of setpoints	2, 4, 16	Select number of setpoints available
<i>rmTr</i>	Remote Tracking	OFF TrAc	Disable Local setpoint tracks remote setpoint
<i>mTr</i>	Manual Track	OFF TrAc	Disable Local setpoint tracks PV when in manual
<i>PrTr</i>	Programmer Track	OFF TrAc	Disable Local setpoint tracks programmer SP
<i>rmPU</i>	Setpoint rate limit units	PSEc Pm, n PHr	Per second Per minute Per hour
<i>rmE</i>	Remote setpoint configuration	nonE SP LocE rmE	Disable Remote setpoint Remote setpoint + local trim Remote trim + local setpoint

AL	Alarm configuration	Values
<i>The controller contains four 'soft' alarms, (indication only) which are configured in this list. Once configured, they can be attached to a physical output in module positions 1A, 2A or 3A.</i>		
<i>AL1</i>	Alarm 1 Type	see Table A
<i>Ltch</i>	Latching	no/YES/Eunt/mAn*
<i>bLoc</i>	Blocking	no/YES
<i>AL2</i>	Alarm 2 Type	see Table A
<i>Ltch</i>	Latching	no/YES/Eunt/mAn*
<i>bLoc</i>	Blocking	no/YES
<i>AL3</i>	Alarm 3 Type	see Table A
<i>Ltch</i>	Latching	no/YES/Eunt/mAn*
<i>bLoc</i>	Blocking	no/YES
<i>AL4</i>	Alarm 4 Type	see Table A
<i>Ltch</i>	Latching	no/YES/Eunt/mAn*
<i>bLoc</i>	Blocking (not if 'AL4' = 'rAL')	no/YES

Table A - Alarm types	
Value	Alarm type
OFF	No alarm
FSL	PV Full scale low
F5H	PV Full scale high
dEu	PV Deviation band
dHi	PV Deviation high
dLo	PV Deviation low
LCr	Load Current low
HCr	Load Current high
FL2	Not usable on 2416
FH2	Not usable on 2416
LOP	Working Output low
HOP	Working Output high
LSP	Working Setpoint low
HSP	Working Setpoint high
rAL	PV Rate of change AL4 only

**\* Alarm Modes**

'no' means that the alarm will be non-latching.

'YES' means that the alarm will be latched, with automatic resetting. Automatic resetting means that if a reset is actioned before the alarm has cleared, then it will automatically reset when it clears.

'Eunt' means that the alarm is used to trip an external event. If this option is selected the front panel alarm message will not appear.

'mAn' means that the alarm will be latched, and can only be reset after it has first cleared (called 'manual reset mode').

Name	Description	Values	Meaning
<i>The following parameters apply if the <b>standard 8-segment programmer</b> is to be configured.</i>			
PARAM	Programmer configuration	Values	Meaning
PTYP	Programmer type	nonE I	Programmer disabled ( <i>factory setting</i> ) 8-segment programmer enabled
HbRC	Holdback	SEG PRoG	Holdback is individually selectable in each segment. Holdback is applied across the whole Program.
PwrF	Power fail recovery	cont rmpb rSEt	Continue from last setpoint (SP) Ramp from PV to SP at last ramp rate Reset the program
Srvo	Starting setpoint of a program (Servo point)	toPV toSP	From the Process Value (PV) From the setpoint

<i>The following parameters apply if a <b>16-segment programmer</b> is to be configured.</i>			
PARAM	Programmer configuration	Values	Meaning
PTYP	Programmer type	nonE I 4	Programmer disabled Single program Four programs
HbRC	Holdback	SEG PRoG	Holdback is individually selectable in each segment. Holdback is applied across the whole Program.
PwrF	Power fail recovery	cont rmpb rSEt	Continue from last setpoint (SP) Ramp from PV to SP at last ramp rate Reset the program
Srvo	Starting setpoint of a program (Servo point)	toPV toSP	From the Process Value (PV) From the setpoint
out	Programmable event outputs	no YES	Disabled Enabled
SYNc	Synchronisation of programs of several programmers  <b>Not usable in Model 2416</b>	no YES	Disabled Enabled Select 'no'

HR	Comms 1 module config		
id	Identity of the module installed	cmS PdS PdS,	EIA-232, or 2-wire EIA-485, or 4-wire EIA-485 comms PDSIO retransmission PDSIO input

Name	Description	Values	Meaning
------	-------------	--------	---------

For 'd' = 'cMS' use this parameter table:

Func	Function	mod	Modbus protocol
		EI b1	Eurotherm Bisynch protocol
bAud	Baud Rate	1200, 2400, 4800, 9600, 19.20(19,200)	
dELY	Delay - quiet period, required by some comms adaptors	no	No delay
		YES	Delay active - 10mS

The following parameters only appear if the function chosen is Modbus protocol.

PrTY	Comms Parity	nonE	No parity
		EuEn	Even parity
		Odd	Odd parity
rES	Comms Resolution	FULL	Full resolution
		Int	Integer resolution
dELY	Delay - quiet period, required by some comms adaptors	no	No delay
		YES	Delay active - 10mS

For 'd' = 'PDS' use this parameter table:

Func	Function	nonE	No PDSIO function
		SP.OP	PDSIO setpoint retransmission
		PV.OP	PDSIO PV retransmission
		Er.OP	PDSIO error signal retransmission
		OP.OP	PDSIO output power retransmission
VAL.L		Retransmitted Value Low	
VAL.H		Retransmitted Value High	

For 'd' = 'PDSi' use this parameter table:

Func	Function	SP, P	PDSIO setpoint input
VAL.L		Setpoint Displayed Value - Low	
		Setpoint Displayed Value - High	

Name	Description	Values	Meaning
<b>IA</b>	<b>Module 1 configuration</b>		
<b>d</b>	Identity of module installed	<i>REL</i> <i>DC</i> <i>LOG</i> <i>SSr</i>	Relay output Non-isolated DC output Logic/PDSIO output Triac output

For 'd' = 'REL', 'LOG', or 'SSr' use this parameter table:			
<b>Func</b>	Function	<i>none</i>	Function disabled
		<i>DIG</i>	Digital output function
		<i>HEAT</i>	Heating output
		<i>COOL</i>	Cooling output
		<i>UP</i>	Open motorised valve
		<i>DOWN</i>	Close motorised valve
			(Only if 'd' = 'LOG')
	(Only if 'd' = 'LOG')	<i>SSr.2</i>	PDSIO mode 2 heating
<b>VAL.L</b>	PID Demand Signal 		% PID demand signal giving minimum output – 'Out.L'
<b>VAL.H</b>			% PID demand signal giving maximum output – 'Out.H'
<b>Out.L</b>			Minimum average power
<b>Out.H</b>			Maximum average power
<b>SENS</b>	Sense of output (Only if 'Func' = 'DIG')	<i>nor</i> <i>inv</i>	Normal (output energises when TRUE, e.g. program events) Inverted (output de-energises when TRUE, e.g. alarms)
When 'SENS' appears, then further parameters are available. See the table on the next page.			

Name	Description	Values	Meaning
<i>The following digital events appear after 'SEnS'. Any one, or more, of the events can be combined on to the output (see Fig. Figure 6-2) by selecting 'YES' in the lower readout.</i>			
1---	Alarm 1 active	YES / no	(- - -) = alarm type (e.g. FSL).
2---	Alarm 2 active	YES / no	If an alarm has not been configured in 'AL CONF' list, then display will differ:- e.g. Alarm 1 = 'AL 1'.
3---	Alarm 3 active	YES / no	
4---	Alarm 4 active	YES / no	
mAn	* Controller in manual mode	YES / no	
Sbr	* Sensor break	YES / no	
SPAn	* PV out of range	YES / no	
Lbr	* Loop break	YES / no	
LdF	* Load failure alarm	YES / no	
tunE	* Tuning in progress	YES / no	
dcF	* Voltage output open circuit, or mA output open circuit	YES / no	
rmLF	* PDS module connection or remote input open circuit	YES / no	
i P IF	* Input 1 fail (not usable on 2416)	YES/no'	
nwAL	* New Alarm has occurred	YES / no	
End	* End of setpoint rate limit, or end of program	YES / no	
SYnc	* Program Synchronisation active	YES / no	(Not available in 2416 - set to 'no')
PrGn	* Programmer event output active, where 'n' = event number from 1 to 8. (Not available with 8-segment programmer.)	YES / no	

\* These alarms are always non-latching. Process alarms 1, 2, 3 and 4 are configurable as alarm latching or non-latching, see the 'AL' List

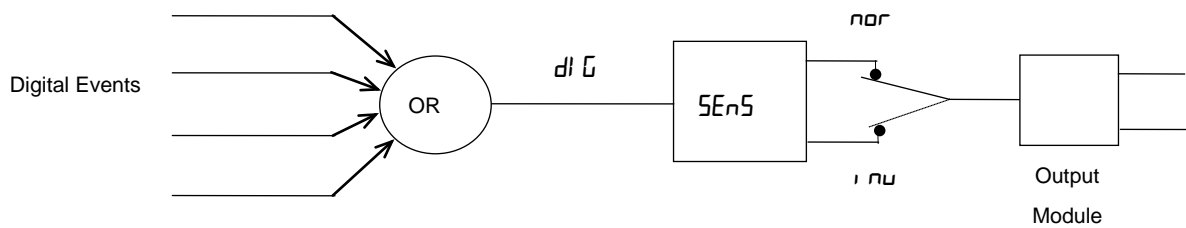

Figure 6-2: Combining several digital events on to one output

Name	Description	Values	Meaning
For 'id' = 'dC.OP', use this parameter table:			
Func	Function	nonE	Function disabled
		HEAT	Heating output
		COOL	Cooling output
		PV	Retransmission of PV
		wSP	Retransmission of setpoint
		Err	Retransmission of error signal
		OP	Retransmission of OP power
VAL.L	%PID, or Retrans'n Value 	% PID, or Retrans'n Value, giving minimum output	
VAL.H		% PID, or Retrans'n Value, giving maximum output	
unit		uolt = Volts, mA = milliamps	
Out.L		Minimum electrical output	
Out.H		Maximum electrical output	

<b>2A</b>	<b>Module 2 configuration</b>		
As per module 1 configuration, but excluding the 'SSr.1', 'SSr.2' options on a logic output.			

<b>3A</b>	<b>Module 3 configuration</b>		
As per module 2 configuration.			

Func	8-point Custom Linearisation <sup>(1)</sup>	
in 1	Displayed Value 	Custom input 1
VAL.1		Linearisation Value representing in 1
in 8		Custom input 8
VAL.8		Linearisation Value representing in 8

**Note:**

1. Custom Linearisation is only available when 'ip- ConF list has 'inpt' set to 'mV.C', or 'mA.C', or 'V.C'
2. Custom curves must be continuously increasing or decreasing in value and input.

Name	Description	Values	Meaning
<b>CAL</b>	<b>Calibration</b>		
<p><i>In this mode you can</i></p> <ol style="list-style-type: none"> <li>1. Calibrate the instrument using a mV source - <i>rCAL</i> or ref source cal.</li> <li>2. Offset the calibration to account for errors in actual sensor measurement and a ref sensor - <i>UCAL</i> or user calibration</li> <li>3. Return to factory set calibration - <i>FACT</i> or factory set calibration.</li> </ol>			
<i>rCAL</i>	Calibration point	<i>nonE</i>	No calibration
		<i>PU</i>	Calibrate main Process Value input.
		<i>PU2</i>	Calibrate DC input, or PV 2.(not 2416)
		<i>IAHi</i>	Calibrate DC output high - Module 1
		<i>IALo</i>	Calibrate DC output low - Module 1
		<i>2AHi</i>	Calibrate DC output high - Module 2
		<i>2ALo</i>	Calibrate DC output low - Module 2
		<i>3AHi</i>	Calibrate DC output high - Module 3
		<i>3ALo</i>	Calibrate DC output low - Module 3

▶ Goto User calibration table-See also chapter 7

▶ Go to input Calibration table

▶ Go to DC Output Calibration table

<b>Input Calibration</b>			
<p>For 'CAL' = 'PU', or 'PU2', the following parameters apply.</p>			
<i>PU</i>	PV Calibration Value	<i>Idle</i>	Idle
		<i>mUL</i>	Select 0mV as the calibration point
		<i>mUH</i>	Select 50mV as the calibration point
		<i>U0</i>	Select 0V as the calibration point
		<i>U10</i>	Select 10V as the calibration point
		<i>CJC</i>	Select 0°C CJC calibration point
		<i>rEd</i>	Select 400Ω as the calibration point
		<i>HI 0</i>	High impedance: 0V cal'n point
		<i>HI 1.0</i>	High impedance: 1.0 Volt cal'n point
		<i>FACT</i>	Restore factory calibration
<i>GO</i>	Start calibration  Select 'YES' with <input type="button" value="▲"/> or <input type="button" value="▼"/>  Wait for calibration to complete.	<i>no</i>	Waiting to calibrate PV point
		<i>YES</i>	Start calibration
		<i>busy</i>	Busy calibrating
		<i>done</i>	PV input calibration completed
		<i>FAIL</i>	Calibration failed

<b>DC Output Calibration</b>			
<p>The following parameters apply to DC output modules ie for <i>rCAL</i> = <i>IAHi</i> to <i>3ALo</i></p>			
<i>cALH</i>	Output Calibration High	<input type="text"/>	<input type="text"/> = Factory set calibration. Trim value until output = 9V, or 18mA
<i>cALL</i>	Output Calibration Low	<input type="text"/>	<input type="text"/> = Factory set calibration. Trim value until output = 1V, or 2mA

<b>User calibration</b>		
<i>UCAL</i>	User calibration enable	Yes/no
<i>PE 1L</i>	Low calibration point for Input 1	The factory calibration point at which the low point offset was performed.
<i>PE 1H</i>	High calibration point for Input 1	The factory calibration point at which the high point offset was performed.
<i>OF 1L</i>	Offset Low for Input 1	Calculated offset, in display units.
<i>OF 1H</i>	Offset High for Input 1	Calculated offset, in display units.



Name	Description	Values	Meaning
<i>PASS</i>	Password configuration		
<i>RECP</i>	Full or Edit level password		
<i>cnFP</i>	Configuration level password		

 **Note:** When passwords are changed please make a note of the new numbers

<i>EXIT</i>	Exit configuration	<i>no/YES</i>	
-------------	--------------------	---------------	--

## 7. Chapter 7 User Calibration

This chapter has five topics:

- WHAT IS THE PURPOSE OF USER CALIBRATION?
- USER CALIBRATION ENABLE
- OFFSET CALIBRATION
- TWO POINT CALIBRATION
- CALIBRATION POINTS AND CALIBRATION OFFSETS

To understand how to select and change parameters in this chapter you will need to have read Chapter 2 - *Operation*, Chapter 3- *Access Levels* and Chapter 6 - *Configuration*.

### 7.1 What is the Purpose of User Calibration?

The basic calibration of the controller is highly stable and set for life. User calibration allows you to offset the 'permanent' factory calibration to either:

1. Calibrate the controller to your reference standards.
2. Match the calibration of the controller to that of a particular transducer or sensor input.
3. Calibrate the controller to suit the characteristics of a particular installation.
4. Remove long term drift in the factory set calibration.

User calibration works by introducing a single point, or two-point, offset onto the factory set calibration.

### 7.2 USER CALIBRATION ENABLE

The User calibration facility must first be enabled in configuration level by setting the parameter 'UCAL' in the CAL CONF list to 'YES'. This will make the User calibration parameters visible in Operator 'FULL' level. This procedure is described in Chapter 6, *Configuration*, but for convenience is summarised below: .

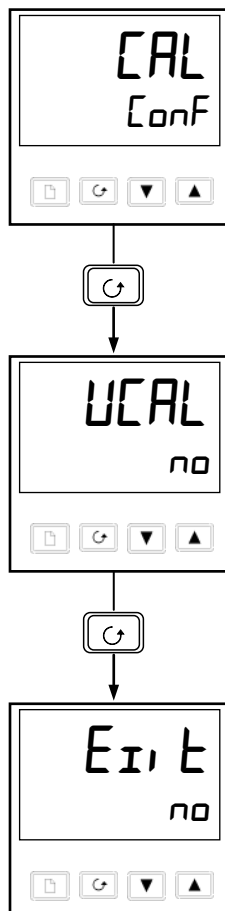

#### The Calibration Configuration List

Press  until you reach the 'CAL-CONF' list.

Press  until you reach 'UCAL'.

#### User Calibration Enable



Use  or  to select:

YES: Calibration enable

no: Calibration disabled

Press  and  together to go to the EXIT display.

#### Exit configuration

Use  or  to select 'YES' to return to Operator level.

### 7.3 Offset Calibration

Offset calibration is used to apply a single fixed offset over the full display range of the controller.

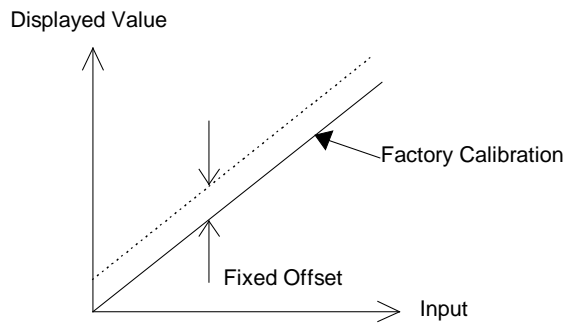

To calibrate, proceed as follows:

1. Connect the input of the controller to the source device to which you wish to calibrate.
2. Set the source to the desired calibration value.
3. The controller will display the current measurement of the value.
4. If the displayed value is correct, then the controller is correctly calibrated and no further action is necessary. If it is incorrect, then follow the steps shown below.

Select 'FULL' access level, as described in Chapter 3.

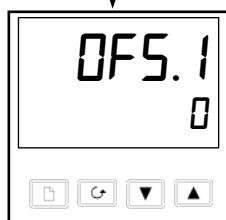
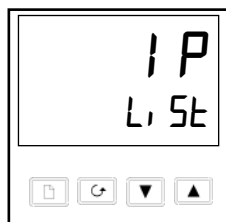

Continued on next page

#### Input list header

Press  until you reach the input list header.

Press  until you reach the 'CAL' display.

#### Calibration type

- **FACT**: Factory Calibration
- **USER**: User Calibration

Use  or  to select 'FACT'.

Selecting 'FACT' reinstates the factory calibration and allows the application of a single fixed offset.

Press 

#### Set Offset 1

Use  or  to set the offset value of Process Value 1 (PV1).

The offset value is in display units.

Press 

The following table shows the parameters which appear after 'OFS. 1'. These are all read only values and are for information.

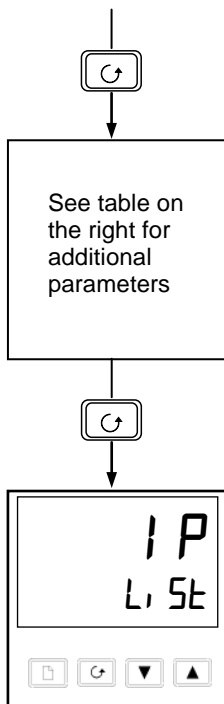

Press  to step through them.

<i>mU. 1</i>	IP1 measured value (at terminals)
<i>[J]. 1</i>	IP1 Cold Junction Compensation
<i>L. 1</i>	IP1 Linearised Value
<i>PUSL</i>	<i>Not available in Model 2416</i>

If you do not want to look at these parameters, then press  and this returns you to the 'P-L, St' header.

To protect the calibration against unauthorised adjustment, return to Operator level and make sure that the calibration parameters are hidden. Parameters are hidden using the 'Edit' facility described in Chapter 3, *Access Levels*.

### 7.4 TWO-POINT CALIBRATION

The previous section described how to apply an offset, or trim, calibration, which applies a fixed offset over the full display range of the controller. A two-point calibration is used to calibrate the controller at two points and applies a straight line between them. Any readings above, or below, the two calibration points will be an extension of this straight line. For this reason it is best to calibrate with the two points as far apart as possible.

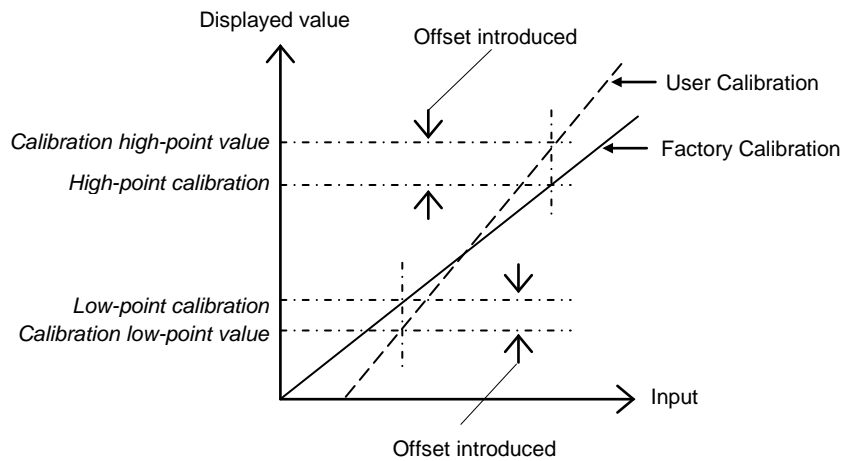

Proceed as follows:

1. Decide upon the low and high points at which you wish to calibrate.
2. Perform a two point calibration in the manner described below.

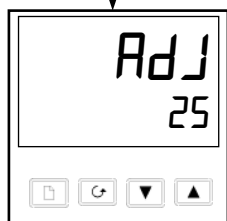
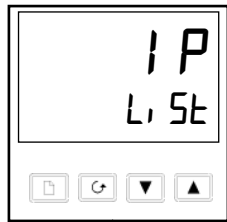

Continued on next page

### Input list header

Press  until you reach the input list header, 'IP L, St'.

Press  until you reach the 'CAL' display.

### Calibration type

- *FAcT*: Factory Calibration
- *USEr*: User Calibration

Use  or  to select 'USEr'.

Selecting 'USEr' enables two-point calibration.



[If two-point calibration is unsatisfactory, select 'FAcT' to return to the factory set calibration.]

Press 

### Select Low-point Calibration

This is the Calibration Status display. This display shows that no input is selected for calibration.



- *nonE*: No selection. If nonE selected go to page 7-4
- *IP L*: Input 1 (PV1) calibration low-point selected
- *IP H*: Input 1 (PV1) calibration high-point selected
- *P2L*: Not available in Model 2416
- *P2H*: Not available in Model 2416

Use /  to select the parameter for the Low Calibration point of Input 1, 'IP L' & follow route shown on this page.

Press 

### Adjust low-point calibration

This is the display for adjusting the Low Calibration point of Input 1. The lower readout is a live reading of the process value, which changes as the input changes.

Make sure that the calibration source is connected to the terminals of Input 1, switched on and feeding a signal to the controller. It should be set to the desired low-point calibration value. If the lower readout does not show this value, then use /  to adjust the reading to the required value.

Press  to return to the 'IP-L, St' header.

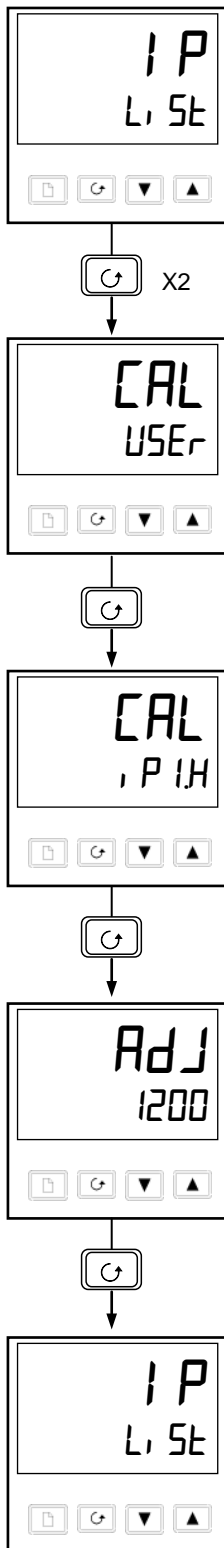

To perform the High-point Calibration, repeat the above procedure, selecting 'P IH' in the 'CAL.S' display for adjustment.

Press twice.

**Calibration type**

'USEr' was selected for the Low-point Calibration, and has remained selected.

Press

**Select High-point Calibration**

This is the Calibration Status display, again.

Use / to select the parameter for the High-point Calibration of Input 1, 'P IH'.

Press

**Adjust High-point Calibration**

This is the display for adjusting the High Calibration point of Input 1. The lower readout is a live reading of the process value, which changes as the input changes.

Feed the desired high-point calibration signal to the controller, from the calibration source. If the lower readout does not show this value, then use / to adjust the reading to the required value.

Press to return to the 'P-L, St' header.

To protect the calibration against unauthorised adjustment return to Operator level and make sure that the calibration parameters are hidden. Parameters are hidden using the 'Edit' facility described in Chapter 3.



## 7.5 CALIBRATION POINTS AND CALIBRATION OFFSETS

If you wish to see the points at which the User calibration was performed and the value of the offsets introduced, then these are shown in Configuration, in 'CAL-CONF'.

The parameters are:

Name	Parameter description	Meaning
PE 1L	Low calibration point for Input 1	The factory calibration point at which the low point offset was performed.
PE 1H	High calibration point for Input 1	The factory calibration point at which the high point offset was performed.
OF 1L	Offset Low for Input 1	Calculated offset, in display units.
OF 1H	Offset High for Input 1	Calculated offset, in display units.



**Note:** The value of each of the parameters in the above table may also be altered by using the /  buttons.

## 8. Chapter 8 LOAD CURRENT MONITORING AND DIAGNOSTICS

Current flowing in a system of electrical heating elements (the 'Load') can be displayed on the controller by using a Eurotherm TE10 SSR fitted with intelligent current transformer, PDCTX, or an SSR or contactor with an external PDCTX.

Load current monitoring and diagnostics may be used with any time proportioned output, fitted in module position 1A, and uses the logic output wires which drive the SSR to return signals back to the controller. These signals represent the RMS value of the load current during the ON period, or load related alarm conditions. It is not designed for analogue outputs i.e. phase angle control.

It is also designed for single phase operation only.

There are two modes of operation:-

### 1. Mode 1

Detects if there is a **break in the heater circuit**. This includes heater or SSR open circuit. A single **Load Failure** alarm message is displayed on the lower readout of the controller.

### 2. Mode 2

Provides the following:-

<b>Display of true RMS load current</b> On the lower readout of the controller	Displays the true RMS current in the ON state to the load.
<b>Low current alarm</b> Analogous to Partial Load Failure (PLF) supplied in some Eurotherm SSRs	Provides advanced warning of failure of one or more heaters in parallel
<b>High current alarm</b> Activated when the heater exceeds a set limit	Typically used where element bunching may occur
<b>SSR short circuit</b>	This will apply full power to the heaters which could result in an over temperature condition. This alarm provides early warning.
<b>Heater failure</b>	Indicates open circuit load conditions



### 8.1 Example Wiring Diagram (For Mode 1 & 2 Operation)

#### Hardware Required

1. Eurotherm SSR type **TE10/PDS2** OR
2. Eurotherm intelligent current transformer type **PD/CTX + contactor or zero voltage switching SSR**
3. 2416 controller configured for PDS mode 2 option using logic output. This module must be fitted in module position 1. (order code **M2**).

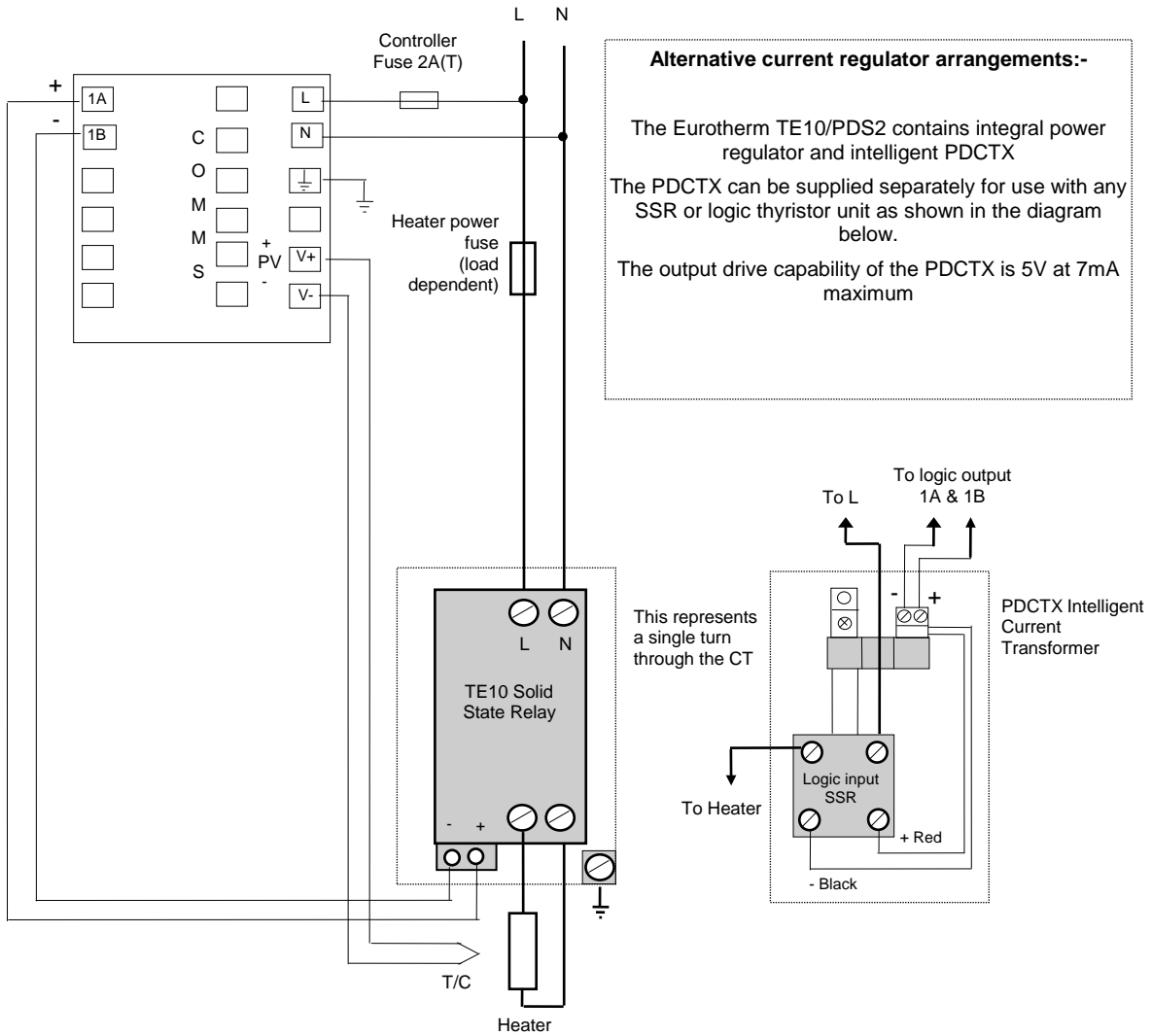





Figure 8-1: Connections for Mode 1 & 2





**Warning:** Take care that the controller is correctly wired for the mode of operation which is configured. Failure to do so may be hazardous in some situations.

## 8.2 OPERATION

### 8.2.1 To Read Load Current (modes 2 and 5 only)

Do This	This Is The Display You Should See	Additional Notes
<p>From the 'i nFa' list</p> <p>Press  until <i>AmPS</i> is shown in the upper display</p>	<div style="display: flex; flex-direction: column; align-items: flex-start;"> <div style="display: flex; align-items: center; margin-bottom: 10px;">  <div style="margin-left: 10px;"> <p>Current will be displayed in the lower readout. See also 'Display Modes' below.</p> </div> </div> <div style="display: flex; align-items: center;">  <div style="margin-left: 10px;"> <p>This display will be shown if:</p> <ol style="list-style-type: none"> <li>1. The controller is unable to resolve the reading</li> <li>2. The controller is obtaining a reading</li> <li>3. The measurement has timed out i.e. current has not flowed for 15 seconds, in mode 2.</li> </ol> </div> </div> </div>	<p>It will revert to the HOME display after 45 seconds or 10 seconds if an alarm is present</p>

### 8.2.2 To Display Load Current Continuously in the Lower Readout (modes 2 and 5 only)

Do This	This Is The Display You Should See	Additional Notes
<p>From the 'HOME' display, <b>Error! Reference source not found..</b></p> <p>Press  until <i>d, 5P</i> is shown in the upper display</p> <p>Press  or  until <i>AmPS</i> is displayed in the lower display</p>		<p>Current will be displayed in the lower readout continuously when the controller reverts to the HOME display, see also 'Display Modes' below.</p>

### 8.2.3 Display Modes

#### SSR RMS On State Current

This is the default state when high or low current alarms are configured. The load current displayed is the steady state true rms current measured during the ON period.

The minimum on times are:-

Mode 2                      0.1second







**8.2.4 How Heater Alarms Are Displayed**

Do This	This Is The Display You Should See	Additional Notes
<p>If an alarm is present it will flash a four character mnemonic in the lower display</p>	<p>Actual Temperature (PV) →</p>  <p>The image shows a digital display labeled 'HOME Display'. At the top, there are two small boxes labeled 'OP1' and 'OP2'. The main display area shows the number '20.0' in a large font. Below the number, the characters 'ILLr' are displayed. At the bottom of the display, there are four navigation buttons: a square, a circular arrow, an upward-pointing triangle, and a downward-pointing triangle. An arrow from the text 'Actual Temperature (PV)' points to the '20.0' value.</p>	<p>If more than one alarm is active, the display will alternate between the alarm messages and the default parameter in the lower display</p>

**The Alarm Messages are:-**





Mnemonic	Meaning	Description
<p>The following two messages are alarms which are produced as a result of failure within the process. In place of dashes the alarm number will appear i.e 1, 2, 3, or 4</p>		
-LLr	Alarm number - <u>L</u> ow <u>C</u> urrent	Used for partial load failure detection. To avoid nuisance tripping due to supply voltage variations set to a value at least 15% below the minimum normal operating current
-HLr	Alarm number - <u>H</u> igh <u>C</u> urrent	Used for load overcurrent protection. To avoid nuisance tripping due to supply voltage variations set to a value at least 15% above the maximum normal operating current.  <b>Note: This alarm is not intended to provide instantaneous safety protection from short circuit fault conditions</b>
<p>The following message is a diagnostic alarm which appears for mode 1 operation only.</p>		
LdF	<u>L</u> oad <u>F</u> ail	This includes failure of the heater circuit or the SSR
<p>The following two messages are diagnostic alarms produced as a result of failure within the equipment or wiring connections. They appear for modes 2 and 5 operation only. They may be enabled using the <i>d</i> AL parameter in the AL L, SE, see 'SHORT CIRCUIT SSR ALARM AND HEATER FAIL ALARM'</p>		
HtrF	<u>H</u> ea <u>t</u> er <u>F</u> ail	No current is being drawn while the controller output demand signal is on
SSrF	<u>S</u> SR <u>F</u> ail	The load is continuously on while the controller output demand signal is off

### 8.3 To Set the Alarm Trip Levels

Do This	This Is The Display You Should See	Additional Notes
From the HOME display (Figure 2.3) press  until the <b>AL L, St</b> is displayed		To select the Alarm List header
Press  button until the desired alarm number is displayed  Press  or  to adjust the alarm trip level	 <div style="border: 1px dashed black; padding: 5px; margin-left: 10px;">                         1 2 3 or 4 indicates the alarm number;                          --- indicates the alarm type:-                          e.g. LCr or HCr                     </div>	To select the diagnostic alarm parameter found under the Alarm List header  The alarm trip level is set to 123

### 8.4 Short Circuit SSR Alarm and Heater Fail Alarm

These alarms exist as **Diagnostic Alarms** in the controller. To make the alarm active it is only necessary to turn on the diagnostic alarm feature in the Alarm List in the Operator Level

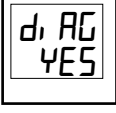
Do This	This Is The Display You Should See	Reason
From the HOME display press  button until the <b>AL L, St</b> is displayed		This opens the list which contains the <b>d, AG</b> mnemonic
Press  until <b>d, AG</b> is displayed  Press  or  to select <b>YES</b>		This activates the <b>d, AG</b> mnemonic to allow Diagnostic Alarms to be displayed in the lower readout of the HOME display

### 8.5 Relay Outputs

Any plug in module can be used for alarms provided they are not already being used for another purpose , such as control. Any one or more alarms can be attached to an output, which will operate when an alarm occurs. Contacts are rated at 2A 264Vac for operating external beacons or audible devices.





























### 8.6 To Configure PDS Load Current Diagnostics

Configuration of PDS load current diagnostics is in four parts:-

1. Configure the Logic Module for PDS Mode 1 or 2 operation.
2. Configure the Low and High Current trip alarms.
3. Attach the alarms to operate an output relay.
4. Set up the Scaling Factor.

First enter Configuration Level. See Chapter 6.











### 8.7 To Configure the Logic Module For PDS Modes 1 or 2

Do This	This Is The Display You Should See	Additional Notes
Press  until the <i>IA Conf</i> is displayed		This opens the configuration list associated with module position 1A
Press  to show <i>id</i>		This shows the identity of the module The module identity is <u>logic</u> output
Press  to show <i>Func</i> Press  or  to show <i>SSr 1</i> or <i>SSr 2</i> as required.		This shows the <u>function</u> of module The module function is set to PDS mode 1
Press  to show <i>UALL</i> Press  or  to show <i>00</i>		This is the lower PID demand level To set the minimum PID signal to 0%
Press  to show <i>UALLH</i> Press  or  to show <i>1000</i>		This is the upper PID demand level To set the maximum PID signal to 100%
Press  to show <i>OUTL</i> Press  or  to show <i>00</i>		This is the minimum output power To set the min output power to 0
 <b>Warning:</b> Take care that the controller is correctly wired for the mode of operation which is configured. Failure to do so may be hazardous in some situations.		
Press  to show <i>OUTH</i> Press  or  to show <i>1000</i>		This is the maximum output power To set the max output power to 100
Press  to show <i>SENS</i> Press  or  to show <i>nor</i>		This sets the output signal to normal for heating control

### 8.8 To Configure Low and High Current Trip Alarms

Alarm 1 will be configured as Load Current Low (LCr)





Alarm 2 will be configured as Load Current High (HCr)

Do This	This Is The Display You Should See	Additional Notes
Press  button until the AL Conf is displayed		This opens the configuration list which contains the Alarms
Press  to show AL 1 (alarm 1) Press  or  to show LCr		To select alarm 1  To make alarm 1 = Low Current
Press  until AL2 (alarm 2) appears Press  or  to show HCr		After 0.5 sec the display will blink to show the alarm type has been accepted  To select alarm 2.  To make alarm 2 = High Current

 **Note:** The above alarms are known as SOFT ALARMS because they are indication only.

### 8.9 TO ATTACH SOFT ALARMS TO A RELAY OUTPUT

Any one alarm indicated above may be attached to an output (normally a relay). Alternatively any combination of alarms may be attached to operate a relay using the procedure below:-

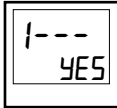
Do This	This Is The Display You Should See	Additional Notes
Press "PAGE" key  as many times as necessary to 3A Conf		Any output module can be configured for an alarm output provided it is not used for any other purpose, eg as a control output.  In place of 3A you should select the module required, i.e. 1A or 2A
Press  until 1--- is displayed Press  or  to select YES or  Repeat the above step for every alarm to be attached to the output		1--- denotes alarm 1 followed by three letters which denote the alarm type e.g. LCr  YES means that the selected output will activate when an alarm occurs in normal operation  no means the output will not activate

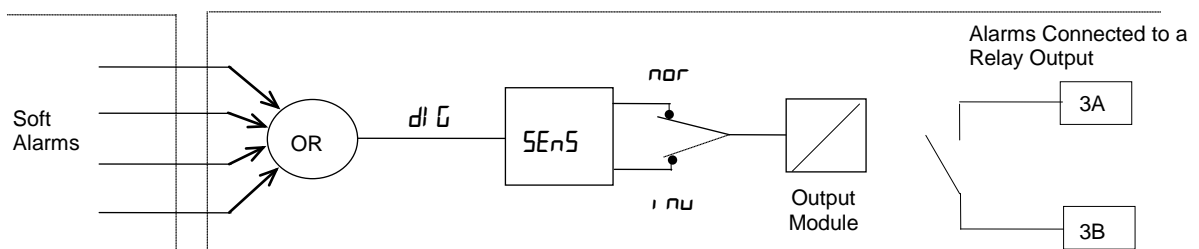







### 8.10 The Scaling Factor

The value of the current displayed on the controller is scaled using the scaling factor. This is found in the `nSt Conf` list. It is set, by default, to 100 and assumes a single turn through the current transformer. If two turns are made through the current transformer it will be necessary to adjust the scaling factor to 50 to obtain the same reading.

Under normal conditions you should not need to change the scaling factor.

If, however, you wish to change the sensitivity of the current reading, for example, to read very low currents you may need to change the number of turns through the PDCTX and/or adjust the scaling factor to compensate. See also note 1 below.

#### 8.10.1 To Adjust the Scaling Factor

Do This	This Is The Display You Should See	Additional Notes
Press  button until <code>nSt Conf</code> is displayed		
Press  until <code>LCM</code> is displayed Press  or  to change the scaling factor		



**Note: Minimum Resolvable Current.**

TE104A RMS. It is not possible to read currents lower than 4A when using a TE10. PDCTX 4A RMS for a single turn through the PDCTX

Should you wish to read currents lower than 4A using a PDCTX it is necessary to increase the number of turns through the PDCTX and adjust the scaling factor to compensate.

For example: To read 1.0A wind 4 turns through the PDCTX and adjust the scaling factor to 25 as shown in the table below.

Scalar = 100/N Where N = Turns through PDCTX			
N	Scalar	N	Scalar
1	100	5	20
2	50	10	10
4	25		



**Note: Maximum Resolvable Current**

TE10 Determined by the maximum range of the SSR  
PDCTX 100A (or 100 ampere turns)

**Finally Exit configuration level.** See Chapter 5

## Appendix A UNDERSTANDING THE ORDERING CODE

The 2416 controller has a modular hardware construction, which accepts up to three plug-in Input/Output modules and one communications module, to satisfy a wide range of control requirements.

The ordering code is in two parts. The hardware coding and an optional configuration coding. The hardware coding specifies the basic build of the controller and the plug-in modules that are fitted.

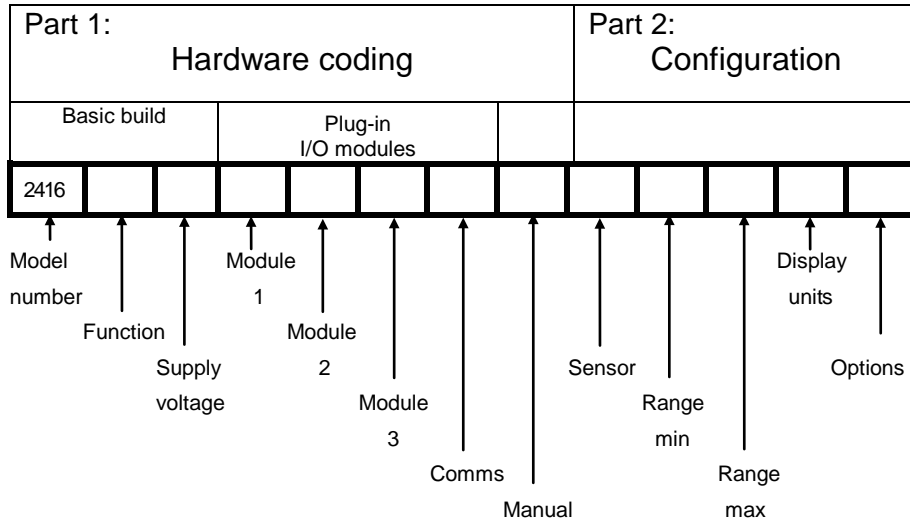

The controller may have been ordered with just the hardware build specified, or with configuration included. This is indicated by the ordering code on the side of the controller.



Basic build			Plug-in modules				
Model number	Function	Supply voltage	Module 1	Module 2	Module 3	Comms	Manual
2416	CC	VH	LH	RC	RH	MB	ENG

Function	
CC	Controller/8-seg Programmer
CP	Single 16-segment Programmer
P4	Four Program 16-segment
VC	Valve positioner (VP) /8 segment Prog.
VP	VP/Single Prog. 16-segment
V4	VP/Four Program. 16-segment

Supply voltage	
VH	100 to 230Vac
VL	20 to 29Vac/dc

Comms	
XX	None
<b>EIA-485 ( 2 wire )</b>	
Y2	Fitted unconfigured
YM	Modbus protocol
YE	EI Bisynch protocol
<b>EIA-232</b>	
A2	Fitted unconfigured
AM	Modbus protocol
AE	EI Bisynch protocol
<b>EIA-485 ( 4 wire )</b>	
F2	Fitted unconfigured
FM	Modbus protocol
FE	EI Bisynch protocol
<b>PDSIO input</b>	
M6	Fitted unconfigured
RS	Setpoint input
<b>PDSIO output</b>	
M7	Fitted unconfigured
PT	PV retransmission
TS	Setpoint retrans
OT	Output retrans

Module 1	
XX	None
<b>Relay: 2-pin</b>	
R2	Fitted unconfigured
RH	PID heating
RU	Valve raise output
<i>Or Alarm 1: select from table A</i>	
<b>Logic non-isolated</b>	
L2	Fitted unconfigured
LH	PID heating
M1	PDSIO mode 1 <sup>(1)</sup>
M2	PDSIO mode 2 <sup>(1)</sup>
<b>Triac</b>	
T2	Fitted unconfigured
TH	PID heating
TU	Valve raise output
<b>DC control non-isolated</b>	
D2	Unconfigured
H1	0-20mA heating
H2	4-20mA heating
H3	0-5Vdc heating
H4	1-5Vdc heating
H5	0-10Vdc heating

Manual	
XXX	No manual
ENG	English
FRA	French
GER	German
ITA	Italian

Module 2	
XX	None
<b>Relay: 2-pin</b>	
R2	Fitted unconfigured
RC	PID cooling
RW	Valve lower output
PO	Program event output 1
<i>Or Alarm 2: select from table A</i>	
<b>Logic non-isolated</b>	
L2	Fitted unconfigured
LC	PID cooling
<b>Triac</b>	
T2	Fitted unconfigured
TC	PID cooling
TW	Valve lower output
<b>DC control non-isolated</b>	
D2	Unconfigured
C1	0-20mA cooling
C2	4-20mA cooling
C3	0-5Vdc cooling
C4	1-5Vdc cooling
C5	0-10Vdc cooling

Table A : Alarm relay functions	
FH	High alarm
FL	Low alarm
DB	Deviation band
DL	Low dev. alarm
DH	High dev alarm

Module 3	
XX	None
<b>Relay: 2-pin</b>	
R2	Fitted unconfigured
PO	Program event 2
LF	PDSIO load failure
HF	PDSIO heater failure
SF	PDSIO SSR failure
<i>Or Alarm 4 select from table A</i>	
<b>Other modules</b>	
L2	Logic unconfigured non-isolated
T2	Triac unconfigured
D2	DC unconfigured non- Isolated
<i>First character</i>	
V-	PV retransmission
S-	Setpoint retransmission
O-	Output retransmission
Z-	Error retransmission
<i>Second character</i>	
-1	0 to 20mA
-2	4 to 20mA
-3	0 to 5V
-4	1 to 5V
-5	0 to 10V

The Hardware code is followed by the Configuration code listed in the following page.

Hardware coding	<b>Part 2: Configuration</b>				
▶ Continued	Sensor input	Range min	Range max	Units	Options
	K	0	1000	C	CF

Sensor input		Range min & max	
<b>Standard sensor inputs</b>		°C	°F
J	J thermocouple	-210 to 1200	-340 to 2192
K	K thermocouple	-200 to 1372	-325 to 2500
T	T thermocouple	-200 to 400	-325 to 750
L	L thermocouple	-200 to 900	-325 to 650
N	N thermocouple	-250 to 1300	-418 to 2370
R	Type R - Pt13%Ph/Pt	-50 to 1768	-58 to 3200
S	Type S - Pt10%Rh/Pt	-50 to 1768	-58 to 3200
B	Type B - Pt30%Rh/Pt6%Rh	0 to 1820	32 to 3308
P	Platinel II	0 to 1369	32 to 2496
C	*Type C W5%Re/W26%Re (Hoskins)*	0 to 2319	32 to 4200
Z	RTD/PT100	-200 to 850	-325 to 1562
<b>Process inputs</b>			
F	-9.99 to + 80mV	0 to 9999	
Y	0-20 mA Linear	0 to 9999	
A	4-20 mA Linear	0 to 9999	
W	0-5V DC Linear	0 to 9999	
G	1-5V DC Linear	0 to 9999	
V	0-10V DC Linear	0 to 9999	
<b>Custom Sensor inputs (* replaces type C thermocouple)</b>			
D	Type D - W3%Re/W25%Re	0 to 2399	32 to 4350
E	E thermocouple	-270 to 1000	-450 to 1830
1	Ni/Ni18%Mo	0 to 1399	32 to 2550
2	Pt20%Rh/Pt40%Rh	0 to 1870	32 to 3398
3	W/W26%Re (Englehard)	0 to 2000	32 to 3632
4	W/W26%Re (Hoskins)	0 to 2010	32 to 3650
5	W5%Re/W26%Re (Englehard)	10 to 2300	50 to 4172
6	W5%Re/W26%Re (Bucose)	0 to 2000	32 to 3632
7	Pt10%Rh/Pt40%Rh	200 to 1800	392 to 3272

Units	
C	Centigrade
F	Fahrenheit
K	Kelvin
X	Blank

Options	
Add as many options as required	
<b>Control options</b>	
NF	On/Off control
DP	Direct acting PID control
PD	Power feedback disabled
<b>Cooling options</b>	
CF	Fan cooling
CW	Water cooling
CL	Oil cooling
<b>Front panel buttons</b>	
MD	Auto/man button disabled
RD	Run/hold button disabled
<b>Programmer options</b>	
HD	Dwell time in hours
HR	Ramp rate in units/hour (minutes is standard)

**Range min and Range max:** Thermocouple and RTD sensor inputs will always display over the full operating range shown in Sensor input table. For these inputs, the values entered here are the low and high setpoint limits. For process inputs, the values are the display scaling corresponding to the minimum and maximum input values.

**Note:** PDSIO is a proprietary technique developed by Eurotherm for bi-directional transmission of analogue and digital data between instruments.

**Mode 1:** provides logic heating to a Eurotherm TE10S solid state relay with feedback of a general load fault alarm.

**Mode 2:** provides logic heating to a Eurotherm TE10S solid state relay with feedback of load current and two alarms: solid state relay failure and heater circuit failure.

## Appendix B SAFETY and EMC INFORMATION

This controller is manufactured in the UK by Eurotherm Ltd.

Please read this section carefully before installing the controller

This controller is intended for industrial temperature and process control applications when it will meet the requirements of the European Directives on Safety and EMC. Use in other applications, or failure to observe the installation instructions of this handbook may impair the safety or EMC protection provided by the controller. It is the responsibility of the installer to ensure the safety and EMC of any particular installation.

### GENERAL

The information contained in this manual is subject to change without notice. While every effort has been made to ensure the accuracy of the information, your supplier shall not be held liable for errors contained herein.

#### Safety

This controller complies with the European Low Voltage Directive 2006/95/EC, by the application of the safety standard EN 61010.

#### Electromagnetic compatibility

This controller conforms with the essential protection requirements of the EMC Directive 2004/108/EC, by the application of appropriate product specific international standards.

This instrument satisfies the general requirements of the commercial and industrial environments defined in EN 61326. For more information on product compliance refer to the Technical Construction File.

#### Unpacking and storage

The packaging should contain an instrument mounted in its sleeve, two mounting brackets for panel installation and an Installation & Operating guide. Certain ranges are supplied with an input adapter.

If on receipt, the packaging or the instrument are damaged, do not install the product but contact your supplier. If the instrument is to be stored before use, protect from humidity and dust in an ambient temperature range of -20°C to +70°C.

### SERVICE AND REPAIR

This controller has no user serviceable parts. Contact your nearest Eurotherm agent for repair.

#### **Caution: Charged capacitors**

Before removing an instrument from its sleeve, disconnect the supply and wait at least two minutes to allow capacitors to discharge. Failure to observe this precaution will expose capacitors that may be charged with hazardous voltages. In any case, avoid touching the exposed electronics of an instrument when withdrawing it from the sleeve.

#### Electrostatic discharge precautions

When the controller is removed from its sleeve, some of the exposed electronic components are vulnerable to damage by electrostatic discharge from someone handling the controller. To avoid this, before handling the unplugged controller discharge yourself to ground.

#### Cleaning

Do not use water or water based products to clean labels or they will become illegible. Isopropyl alcohol may be used to clean labels. A mild soap solution may be used to clean other exterior surfaces of the product.

## INSTALLATION SAFETY REQUIREMENTS

### Symbols

If any of the symbols shown below are used on the instrument they have the following meaning:

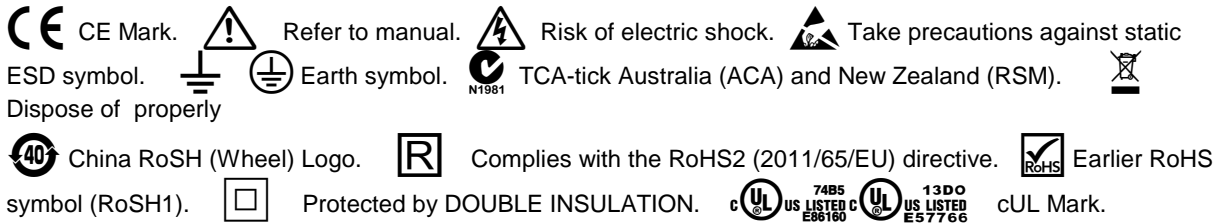

### Personnell

Installation must only be carried out by suitably qualified personnel.

### Enclosure of live parts

To prevent hands or metal tools touching parts that may be electrically live, the controller must be installed in an enclosure.

### Caution: Live sensors

All isolated inputs and outputs have reinforced insulation to provide protection against electric shock. The non-isolated dc, logic and PDSIO outputs are all electrically connected to the main process variable input, (thermocouple etc.). If the temperature sensor is connected directly to an electrical heating element then these non-isolated inputs and outputs will also be live. The controller is designed to operate under these conditions. However you must ensure that this will not damage other equipment connected to these inputs and outputs and that service personnel do not touch connections to these i/o while they are live. With a live sensor, all cables, connectors and switches for connecting the sensor and non-isolated inputs and outputs must be mains rated.

### Wiring

It is important to connect the controller in accordance with the wiring data given in this handbook. Take particular care not to connect AC supplies to the low voltage sensor input or DC or logic inputs and output. Only use copper conductors for connections (except thermocouple inputs) and ensure that the wiring installations comply with all local wiring regulations. For example in the UK use the latest version of the IEE wiring regulations, (BS7671). In the USA use NEC Class 1 wiring methods.

### Power Isolation

The installation must include a power isolating switch or circuit breaker. This device should be in close proximity to the controller, within easy reach of the operator and marked as the disconnecting device for the instrument.

### Earth leakage current

Due to RFI Filtering there is an earth leakage current of less than 0.5mA. This may affect the design of an installation of multiple controllers protected by Residual Current Device, (RCD) or Ground Fault Detector, (GFD) type circuit breakers.

### Overcurrent protection

To protect the internal PCB tracking within the controller against excess currents, the AC power supply to the controller and power outputs must be wired through the fuse or circuit breaker specified in the technical specification.

### Voltage rating

The maximum continuous voltage applied between any of the following terminals must not exceed 230Vac +15%:

- relay output to logic or dc sensor connections;
- any connection to ground.

The controller should not be wired to a three phase supply with an unearthed star connection. Under fault conditions such a supply could rise above 264Vac with respect to ground and the product would not be safe.

### Conductive pollution

Electrically conductive pollution must be excluded from the cabinet in which the controller is mounted. For example, carbon dust is a form of electrically conductive pollution. To secure a suitable atmosphere, fit an air filter to the air intake of the cabinet. Where condensation is likely, for example at low temperatures, include a thermostatically controlled heater in the cabinet.

This product has been designed to conform to BSEN61010 installation category II, pollution degree 2. These are defined as follows:-

## Installation Category II

The rated impulse voltage for equipment on nominal 230V supply is 2500V.

### Pollution Degree 2

Normally only non conductive pollution occurs. Occasionally, however, a temporary conductivity caused by condensation shall be expected.

### Over-temperature protection

When designing any control system it is essential to consider what will happen if any part of the system should fail. In temperature control applications the primary danger is that the heating will remain constantly on. Apart from spoiling the product, this could damage any process machinery being controlled, or even cause a fire.

Reasons why the heating might remain constantly on include:

- the temperature sensor becoming detached from the process;
- thermocouple wiring becoming short circuit;
- the controller failing with its heating output constantly on;
- an external valve or contactor sticking in the heating condition;
- the controller setpoint set too high.

Where damage or injury is possible, we recommend fitting a separate over-temperature protection unit, with an independent temperature sensor, which will isolate the heating circuit.

Please note that the alarm relays within the controller will not give protection under all failure conditions.

### Grounding of the temperature sensor shield

In some installations it is common practice to replace the temperature sensor while the controller is still powered up. Under these conditions, as additional protection against electric shock, we recommend that the shield of the temperature sensor is grounded. Do not rely on grounding through the framework of the machine.

## INSTALLATION REQUIREMENTS FOR EMC

To ensure compliance with the European EMC directive certain installation precautions are necessary as follows:

- For general guidance refer to Eurotherm EMC Installation Guide, HA025464.
- When using relay or triac outputs it may be necessary to fit a filter suitable for suppressing the emissions. The filter requirements will depend on the type of load.
- If the unit is used in table top equipment which is plugged into a standard power socket, then it is likely that compliance to the commercial and light industrial emissions standard is required. In this case to meet the conducted emissions requirement, a suitable mains filter should be installed.

### Routing of wires

To minimise the pick-up of electrical noise, the wiring for low voltage dc and particularly the sensor input should be routed away from high-current power cables. Where it is impractical to do this, use shielded cables with the shield grounded at both ends. In general keep cable lengths to a minimum.

## Appendix C Technical Specification

### Input

Range	$\pm 100\text{mV}$ and 0 to 10Vdc (auto ranging)
Sample Rate	9Hz (110mS)
Resolution	$<1\mu\text{V}$ for $\pm 100\text{mV}$ range, $<0.2\text{mV}$ for 10Vdc range
Linearity	Better than $0.2^\circ\text{C}$
Calibration accuracy	The greater of 0.25% of reading or $\pm 1^\circ\text{C}$ or $\pm 1\text{LSD}$
User calibration	Low and high offsets can be applied
Input filter	Off to 999.9 seconds
Thermocouple types	Refer to the ordering code sensor input table
Cold junction compensation	$>30$ to 1 rejection of ambient temperature changes in automatic mode. Uses INSTANT ACCURACY™ cold junction sensing technology to eliminate warm up drift and to respond quickly to ambient temperature changes. External references 0, 45, and $50^\circ\text{C}$
RTD/PT100 input	3-wire, Pt100 DIN43750. Bulb current 0.3mA. Up to $22\Omega$ in each lead without error

### Digital Outputs

Relay rating	Min: 12V, 100mAdc. Max: 2A, 264Vac resistive Application: heating, cooling, alarms or program event
Single logic output	18Vdc, 20mA. This output is not isolated from the main process value input. Application: heating, cooling, alarms or program event
Digital o/p functions	As per the ordering code
Triac rating	1A, 30 to 264Vac resistive (isolated)

### Analogue outputs

Range	Scaleable between 0-10Vdc 0-20mA (non-isolated)
Analogue output functions	Refer to ordering code

### Control functions

Control modes	PID or PI with overshoot inhibition, PD, PI, P, or On/Off, or motorised valve control
Cooling algorithms	Linear, water (non-linear), fan (min on time), oil
Tuning	One shot (automatic tune of PID and overshoot inhibition parameters) and continuous adaptive tuning. Automatic calculation of manual reset value when using PD control.
Auto/manual control	Bumpless transfer or forced manual output
Setpoint rate limit	0.00 to 999.9 display units per second, minutes or hour

**Alarms**

Number of alarms	Four
Alarm types	Absolute high or low. Deviation band, deviation high, deviation low. Rate of change
Alarm modes	Latching or non-latching. Blocking. Energised or de-energised in alarm

**Setpoint programming**

Number of programs	One or four
Segments per program	16
Event outputs	Up to two

**Communications** (all modules are isolated)

Modbus ®	RS232,2-wire,RS 485 and 4 wire RS485 modules
Baud rate	1200, 2400, 4800, 9600 and 19,200 baud

**PDSIO**

Slave input (isolated)	Remote setpoint input with holdback to master
Master output	Isolated from main PV. Retransmission of setpoint, process value or output

**General**

Display	Dual, 4 digit x 7 segment LED. Up to two decimal places
Supply	100 to 230Vac $\pm$ 15%, 48 to 62 Hz, 10 W max OR 24Vdc or ac -15%, +20%. 10W max
Operating ambient	0 to 55°C and 5 to 90% RH non-condensing
Storage temperature	-10 to +70°C
Panel sealing	IP65
Dimensions	48mm wide x 48mm high x 150mm deep
Weight	250g
EMC standards	EN50081-2 & EN 50082-2 generic standards for industrial environments
Safety standards	Meets EN61010, installation category II (voltage transients must not exceed 2.5kV), pollution degree 2
Atmospheres	Not suitable for use above 2000m or in explosive or corrosive atmospheres. Electrically conductive pollution must be excluded from the cabinet in which this controller is mounted

This page is intentionally blank



**Eurotherm:** International sales and support

[www.eurotherm.com](http://www.eurotherm.com)

**Contact Information**

Eurotherm Head Office  
Faraday Close,  
Durrington,  
Worthing, West Sussex,  
BN13 3PL

**Sales Enquiries**

T +44 (01903) 695888  
F 0845 130 9936

**General Enquiries**

T +44 (01903) 268500  
F 0845 265982

**Worldwide Offices**

[www.eurotherm.com/global](http://www.eurotherm.com/global)



Scan for local contacts

*Represented by:*

© Copyright Eurotherm Limited 2014

Eurotherm by Schneider Electric, the Eurotherm logo, Chessell, EurothermSuite, Mini8, Eycon, Eyris, EPower, EPack, nanodac, piccolo, versadac, optivis, Foxboro and Wonderware are trademarks of Schneider Electric, its subsidiaries and affiliates. All other brands may be trademarks of their respective owners. All rights are strictly reserved. No part of this document may be reproduced, modified, or transmitted in any form by any means, nor may it be stored in a retrieval system other than for the purpose to act as an aid in operating the equipment to which the document relates, without the prior written permission of Eurotherm Limited. Eurotherm Limited pursues a policy of continuous development and product improvement. The specifications in this document may therefore be changed without notice. The information in this document is given in good faith, but is intended for guidance only. Eurotherm Limited will accept no responsibility for any losses arising from errors in this document.

HA025041/12 (CN32071)

2408/2404 User Manual



## Artisan Technology Group is your source for quality new and certified-used/pre-owned equipment

- FAST SHIPPING AND DELIVERY
- TENS OF THOUSANDS OF IN-STOCK ITEMS
- EQUIPMENT DEMOS
- HUNDREDS OF MANUFACTURERS SUPPORTED
- LEASING/MONTHLY RENTALS
- ITAR CERTIFIED SECURE ASSET SOLUTIONS

### SERVICE CENTER REPAIRS

Experienced engineers and technicians on staff at our full-service, in-house repair center

### *InstraView*<sup>SM</sup> REMOTE INSPECTION

Remotely inspect equipment before purchasing with our interactive website at [www.instraview.com](http://www.instraview.com) ↗

### WE BUY USED EQUIPMENT

Sell your excess, underutilized, and idle used equipment. We also offer credit for buy-backs and trade-ins. [www.artisanng.com/WeBuyEquipment](http://www.artisanng.com/WeBuyEquipment) ↗

### LOOKING FOR MORE INFORMATION?

Visit us on the web at [www.artisanng.com](http://www.artisanng.com) ↗ for more information on price quotations, drivers, technical specifications, manuals, and documentation

**Contact us:** (888) 88-SOURCE | [sales@artisanng.com](mailto:sales@artisanng.com) | [www.artisanng.com](http://www.artisanng.com)