



## Artisan Technology Group is your source for quality new and certified-used/pre-owned equipment

- FAST SHIPPING AND DELIVERY
- TENS OF THOUSANDS OF IN-STOCK ITEMS
- EQUIPMENT DEMOS
- HUNDREDS OF MANUFACTURERS SUPPORTED
- LEASING/MONTHLY RENTALS
- ITAR CERTIFIED SECURE ASSET SOLUTIONS

### SERVICE CENTER REPAIRS

Experienced engineers and technicians on staff at our full-service, in-house repair center

### *InstraView*<sup>SM</sup> REMOTE INSPECTION

Remotely inspect equipment before purchasing with our interactive website at [www.instraview.com](http://www.instraview.com) ↗

### WE BUY USED EQUIPMENT

Sell your excess, underutilized, and idle used equipment. We also offer credit for buy-backs and trade-ins. [www.artisanng.com/WeBuyEquipment](http://www.artisanng.com/WeBuyEquipment) ↗

### LOOKING FOR MORE INFORMATION?

Visit us on the web at [www.artisanng.com](http://www.artisanng.com) ↗ for more information on price quotations, drivers, technical specifications, manuals, and documentation

**Contact us:** (888) 88-SOURCE | [sales@artisanng.com](mailto:sales@artisanng.com) | [www.artisanng.com](http://www.artisanng.com)

PDH Concept  
Guide

# HP 37717C Communications Performance Analyzer

---

© Copyright Hewlett-Packard Ltd. 1998

All rights reserved. Reproduction, adaptation, or translation without prior written permission is prohibited, except as allowed under the copyright laws.

Information in this document may apply to modules which use the VxWORKS TM software. The VxWORKS TM software was developed by Wind River Systems, Inc., which has copyright to it.

HP Part No. 37717-90407

First edition, March 98

Printed in U.K.

### Documentation Warranty

The information contained in this document is subject to change without notice.

*Hewlett-Packard makes no warranty of any kind with regard to this material, including, but not limited to, the implied warranties or merchantability and fitness for a particular purpose.*

Hewlett-Packard shall not be liable for errors contained herein or for incidental or consequential damages in connection with the furnishing, performance, or use of this material.

### WARNING

Warning Symbols Used on the Product



The product is marked with this symbol when the user should refer to the instruction manual in order to protect the apparatus against damage.

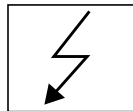

The product is marked with this symbol to indicate that hazardous voltages are present



The product is marked with this symbol to indicate that a laser is fitted. The user should refer to the laser safety information in the Calibration Manual.

---

Hewlett-Packard Limited  
Telecommunications Networks Test Division  
South Queensferry  
West Lothian, Scotland EH30 9TG

---

# HP 37717C Communications Performance Analyzer

---

## About This Book

The information on PDH testing in this book covers the following subjects:

- An Introduction to PDH, the PDH modules and their features.
- Measurement examples.
- Measurement result definitions
- Logging messages

---

## Contents

### **1 Introduction to PDH Testing**

Introduction to PDH / DS<sub>n</sub> 2

Unstructured PDH Generation and Measurement. Option UKK (USB)  
3

Structured PDH Generation and Measurement. Options UKJ (USA)  
and UKN (USE) 4

Binary Interfaces. Option UH3 (US7) 5

Multiple PDH Outputs. Option UHC (US6) 6

DS1, DS3, E1 and E3 Transmit and Receive Interfaces for PDH/DS<sub>n</sub>  
Payloads. Option 110 7

### **2 PDH / DS<sub>n</sub> Testing**

Alarm Monitoring 10

Analysis of N x 64 kb/s 13

BERT Testing 17

Cross Multiplexer Testing 22

FAS Monitoring 28

Frequency Measurement 32

Frequency Offset Tolerance 35

Multiplexer Testing 39

Round Trip Delay 44

M.2100, M.2110, M.2120 Analysis 47

### **3 Result Definitions**

Trouble Scan 52

Short Term Results 53

---

Contents

Cumulative Results 54

PDH Error Analysis G.821, G.826, M.2100, M.2110, M.2120 55

Alarm Seconds 70

Frequency Measurement 71

## **4 PDH Logging Messages**

Logging Devices 74

Results Logging 75

---

# 1

Introduction to PDH / DS<sub>n</sub> page 2

Unstructured PDH Generation and Measurement. Option UKK (USB) page 3

Structured PDH Generation and Measurement. Options UKJ (USA) and UKN (USE) page 4

Binary Interfaces. Option UH3 (US7) page 5

Multiple PDH Outputs. Option UHC (US6) page 6

DS1, DS3, E1 and E3 Transmit and Receive Interfaces for PDH/DS<sub>n</sub> Payloads. Option 110  
page 7

---

## Introduction to PDH Testing

Information on PDH in general and the PDH test features of the HP 37717C.



## Introduction to PDH / DSn

The Plesiochronous Digital Hierarchy (PDH / DSn) is still the dominant technology in most existing telecommunications networks throughout the world, although it is being replaced in many networks by Synchronous Digital Hierarchy (SDH) or SONET networks. PDH / DSn networks were developed at a time when point-to-point transmission was the predominant network requirement. To support this requirement, the standard approach to network management and maintenance was to use manual distribution frames for access to individual signals. This is now considered out of date and consequently SDH / SONET is now the preferred network topology for new installations.

However PDH / DSn networks will exist for a long time to come even in networks where SDH /SONET is the preferred technology. PDH is the ETSI international standard, based on 2 Mb/s, defined by the ITU-T, and covers the hierarchal transmission rates of 2 Mb/s, 8 Mb/s, 34 Mb/s and 140 Mb/s. DSn is the ANSI standard covering transmission rates of 1.544 Mb/s (DS1) and 44.736 Mb/s (DS3). PDH is asynchronous at 8 Mb/s, 34 Mb/s and 140 Mb/s. In order to access a signal, for rerouting or test purposes, the whole line signal structure must be demultiplexed step by step down to the 2 Mb/s level, because of the asynchronous nature of the multiplexing.

At each multiplexing step, the bit rate of the individual tributary signals is controlled within specified limits and is not synchronized with the multiplex equipment. Because the bit rates of the individual tributaries are controlled within specific limits this type of multiplexing is referred to as Plesiochronous i.e. nearly synchronous. The individual tributaries are synchronized with the equipment at each multiplex step by the process of positive bit stuffing justification.

In new SDH / SONET networks, PDH / DSn signals are mapped into virtual containers / tributaries before being transported as part of the SDH / SONET payload. The SDH / SONET payload must then be demapped into a PDH / DSn tributary signal.

Therefore all PDH / DSn, SDH / SONET and mixed PDH/SDH DSn / SONET networks require test sets which have PDH / DSn interfaces and PDH / DSn test capability.

---

## Unstructured PDH Generation and Measurement. Option UKK (USB)

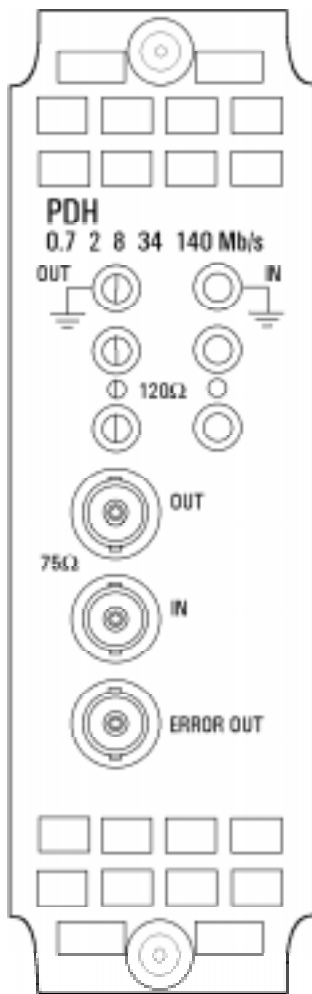

Option UKK (USB), Unstructured PDH, provides generation and measurement of unstructured PDH at interface rates of 704 kb/s, 2.048 Mb/s, 8.448 Mb/s, 34.368 Mb/s and 139.264 Mb/s

Allows the addition of Frequency Offset to the PDH signal

Provides 75  $\Omega$  unbalanced or 120  $\Omega$  balanced input and output interfaces.

Allows selection of PRBS, WORD or USER patterns

Allows selection of Line Code AMI, HDB3 or CMI

Provides an ECL pulse each time an error occurs (Error Out)

**Option UKK [USB]**

---

## **Structured PDH Generation and Measurement. Options UKJ (USA) and UKN (USE)**

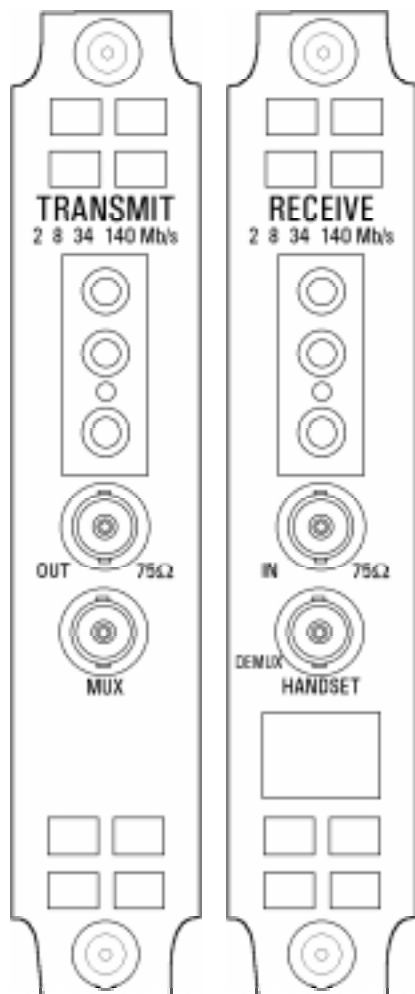

Options UKJ (USA) and UKN (USE), provide generation and measurement of Structured or Unstructured PDH at interface rates of 2.048 Mb/s (E1), 8.448 Mb/s (E2), 34.368 Mb/s (E3) and 139.264 Mb/s (E4).

Structured test signal rates of 64 kb/s, 2.048 Mb/s, 8.448 Mb/s and 34.368 Mb/s are provided.

Frequency Offset can be added at the interface rates.

Line rate frequency can be measured.

Provides 75  $\Omega$  unbalanced or 120  $\Omega$  balanced input and output interfaces.

Allows selection of PRBS, WORD or USER patterns

Allows selection of Line Code AMI, HDB3 or CMI

Interface and test signal rates can be Framed or Unframed

MUX connector allows a 2 Mb/s signal from external equipment to be inserted into the HP 37717C test signal.

DEMUX connector allows a 2 Mb/s signal from the HP 37717C to be Dropped to external equipment.

Option UKN (USE) also provides generation and measurement of PDH signals with ATM payloads.

Information on the ATM capabilities of the UKN (USE) module is given in the "Users Guide" and the "ATM Concept Guide".

### **Option UKJ (USA)**

---

## Binary Interfaces. Option UH3 (US7)



Option UH3 (US7) provides binary NRZ interfaces for the structured PDH module option UKJ (USA), and the unstructured PDH module option UKK (USB).

The interfaces can operate at any of the standard rates  $\pm 100$  ppm.

When used with option UKK (USB), with an external binary clock input, the interfaces can operate at any rate in the range 700 kb/s to 170 Mb/s.

TTL signal levels, at data and clock ports, and external clock port, are valid from 700 kb/s to 50 Mb/s,  $75\Omega$  to ground.

ECL signals, at data and clock ports, and external clock port, are valid from 700 kb/s to 170 Mb/s,  $75\Omega$  to -2V.

The external clock input may be used to clock **coded** data from the PDH / DS<sub>n</sub> transmitter at standard rates. In addition if Option UKK (USB), Unstructured PDH, is fitted can clock **coded** data in the range 700 kb/s to 170 Mb/s.

Simultaneous jitter of binary clock and binary data outputs is possible (2, 8, 34 & 140 Mb/s) if Option UHK (USB) or A3K, Jitter Generator, is fitted.

Jitter measurement on the binary clock input is possible (2, 8, 34 & 140 Mb/s  $\pm 100$  ppm) if Option UHN, A3L, A3V or A3N, Jitter Measurement, is fitted.

Frequency measurement of the external clock input and binary clock input is provided.

### Option UH3 (US7)

---

## Multiple PDH Outputs. Option UHC (US6)

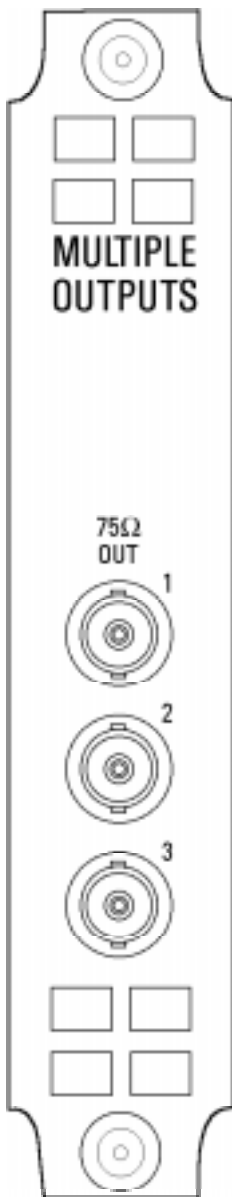

Option UHC (US6), Multiple PDH Outputs, provides three additional 75Ω PDH outputs.

OUT 1 is delayed by 4 bits relative to the main PDH OUT.

OUT 2 is delayed by 8 bits relative to the main PDH OUT.

OUT 3 is delayed by 12 bits relative to the main PDH OUT.

---

## **DS1, DS3, E1 and E3 Transmit and Receive Interfaces for PDH/DSn Payloads. Option 110**

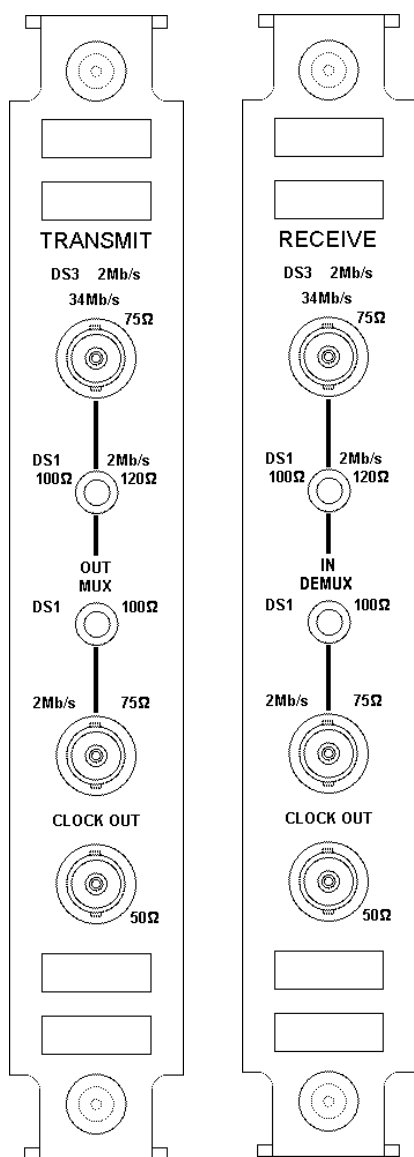

Option 110, provides generation and measurement of PDH /DSn signals at interface rates of: 1.544 Mb/s (DS1), 44.736 Mb/s (DS3), 2.048 Mb/s (E1), and 34.368 Mb/s (E3).

Frequency Offset can be added at the interface rates.

Line rate frequency can be measured.

Provides the following RZ input and output interfaces:

DS3 and E3: 75 Ω unbalanced

E1: 75 Ω unbalanced, 120 Ω balanced.

DS1: 100 Ω balanced.

Allows selection of Line Code as:

AMI or B8ZS at DS1

AMI or HDB3 at 2Mb/s.

At DS3 the line code is fixed at B3ZS.

At 34 Mb/s the line code is fixed at HDB3.

Provides Input sensitivity level selection.

Provides output level control for DS1 and DS3.

DS1: DSX-1 or DS1-LO

DS3: DS3-HI, DSX-3 or DS3-900'.

Allows errors and alarms to be injected into the test signal.

An E1 Drop/Insert port allows an E1(2.048 Mb/s) signal to be dropped/inserted from a E3 (34 Mb/s) signal. In conjunction with the SONET/SDH test module (option 120), this port allows the insertion of E1 into a TU-12/VT2.

A DS1 Drop/Insert port allows a DS1 signal to be dropped/inserted from a DS3 or TU-11/VT1.5 when used in conjunction with the SONET/SDH test module.

Introduction to PDH Testing

**DS1, DS3, E1 and E3 Transmit and Receive Interfaces for PDH/DSn  
Payloads. Option 110**

---

## 2

Alarm Monitoring	page 10
Analysis of N x 64 kb/s	page 13
BERT Testing	page 17
Cross Multiplexer Testing	page 22
FAS Monitoring	page 28
Frequency Measurement	page 32
Frequency Offset Tolerance	page 35
Multiplexer Testing	page 39
Round Trip Delay	page 44
M.2100, M.2110, M.2120 Analysis	page 47

---

## PDH / DS<sub>n</sub> Testing

This Chapter gives examples of the instrument operation in typical PDH test applications.



## **Alarm Monitoring**

**Options Required** Structured PDH UKJ (USA), 110 or UKN (USE)

### **Application**

Problems in the network at all levels in the hierarchy can be detected by the occurrence of alarms in each tributary of structured PDH systems.

Using the HP 37717C in a *receive only* mode, each tributary can be scanned and the state of Frame Loss, Remote (RAI) and AIS alarms viewed on the **RESULTS** display.

### **Default (Known State) Settings**

It can be advisable to set the HP 37717C to a known state prior to setting up to make a measurement. This clears all previous settings and provides a clearly defined instrument state. Select **OTHER**, **STORED SETTINGS**, set STORED SETTINGS NUMBER to 0 and ACTION to **RECALL**.

### **Test Setup Procedure (Alarm Monitoring)**

This setup procedure is based on Structured PDH 140 Mb/s line traffic interfaced at the line equipment 75  $\Omega$  protected Monitor point. If a protected Monitor Point is not available then an HP 15510A Protective Probe may be used at an unprotected Monitor point.

When 120  $\Omega$  Balanced alarm monitoring is desired at an unprotected Monitor point use an HP 15511A Protective Monitor Probe. The instrument is used in a *receive only* mode to monitor Frame Loss, AIS and Remote alarms.

PDH / DS<sub>n</sub> Testing  
**Alarm Monitoring**

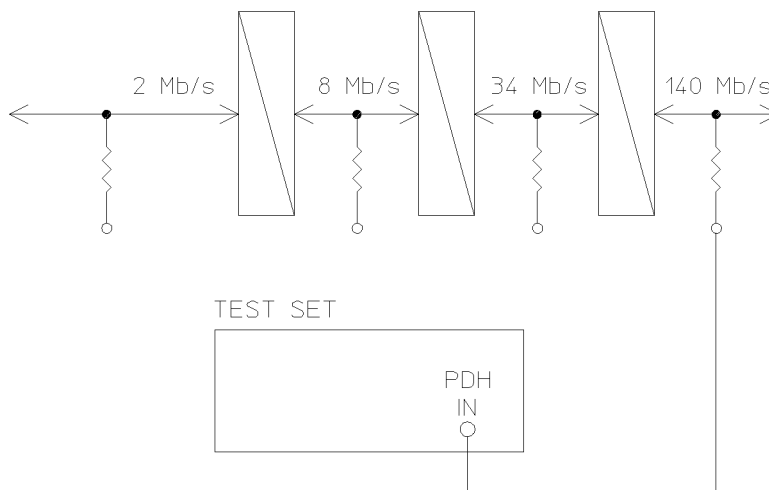

- 1 Connect the HP 37717C to the line terminal equipment protected Monitor point and set up the **RECEIVE** display **MAIN SETTINGS** as shown opposite.

The GAIN and EQUALIZER settings should be set to optimize the received signal.

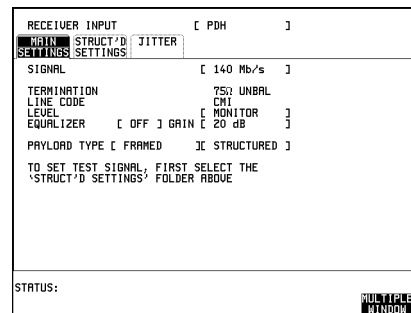

- 2 Set up the **RECEIVE** display **STRUCTURED SETTINGS** as shown opposite.

2M PAYLOAD determines the Framing and selection which should match that of the network equipment.

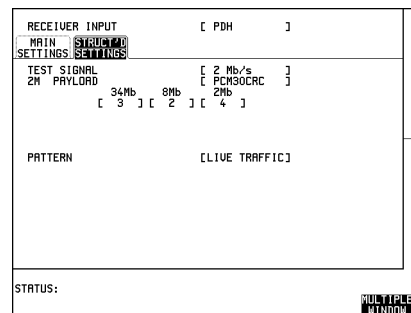

## PDH / DS<sub>n</sub> Testing Alarm Monitoring

### Start the Test (Alarm Monitoring)

- 1 Set up the **RESULTS** display as shown opposite and select **PDH ALM SCAN ON**.

If any of the three alarms, Frame Loss, RAI or AIS has occurred the appropriate point in the hierarchy will be highlighted.

The test can be halted at any time by selecting **OFF** on the **RESULTS PDH ALM SCAN** display.

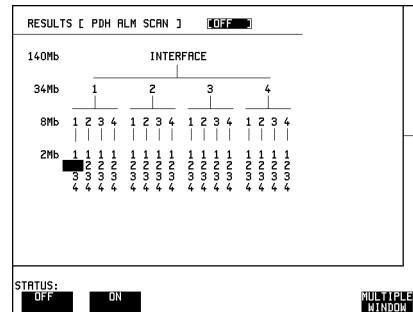

- 2 To determine which alarm has occurred set the PDH ALM SCAN **OFF** and then set the **RECEIVE STRUCTURED SETTINGS** display to the tributary highlighted as shown opposite and press **RUN/STOP**.

*Example 2Mb number 2 of 8Mb number 1 of 34 Mb number 1 is highlighted.*

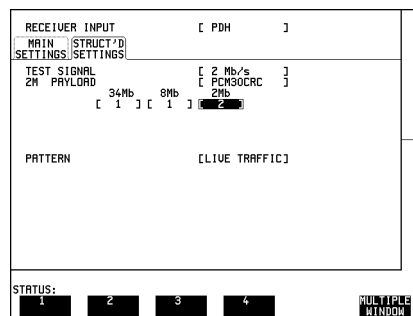

- 3 Now view the Alarm Seconds results on the **RESULTS** display to determine which alarms have occurred.

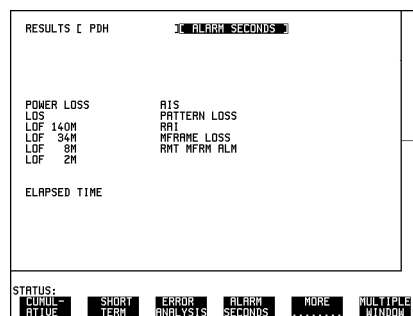

PDH / DS<sub>n</sub> Testing  
Analysis of N x 64 kb/s

---

## Analysis of N x 64 kb/s

**Option Required** Structured PDH UKJ (USA) or DS1,DS3,E1, E3 structured PDH 110

### Application

Many customer premises receive subrate signals for example 128 Kb/s or 384 kb/s. The timeslots which make up these services may or may not be contiguous. Testing these services requires that the test set to be able to insert a pattern across the required timeslots.

Testing N x 64 kb/s channels structured within a 2 Mb/s signal can be carried out on an End to End basis using two test sets.

### Default (Known State) Settings

It can be advisable to set the HP 37717C to a known state prior to setting up to make a measurement. This clears all previous settings and provides a clearly defined instrument state. Select **OTHER**, **STORED SETTINGS**, set STORED SETTINGS NUMBER to 0 and ACTION to **RECALL**.

### Test Setup Procedure (N x 64 kb/s Analysis)

This setup procedure is interfaced at 2 Mb/s, with a test signal of 6 X 64 kb/s non-contiguous timeslots. A PRBS test pattern is transmitted across the 6 timeslots. A BER measurement is performed on the received test pattern.

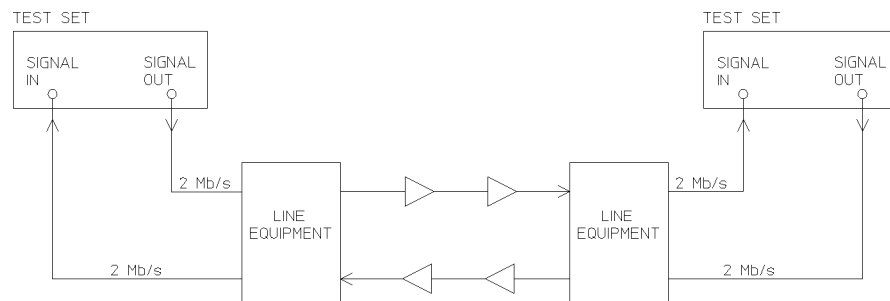

PDH / DSn Testing  
**Analysis of N x 64 kb/s**

**HP 37717C #1**

1. Set up the **OTHER SETTINGS CONTROL** display as shown opposite.

Any settings change made on the **TRANSMIT** or **RECEIVE** displays will automatically occur on the other.

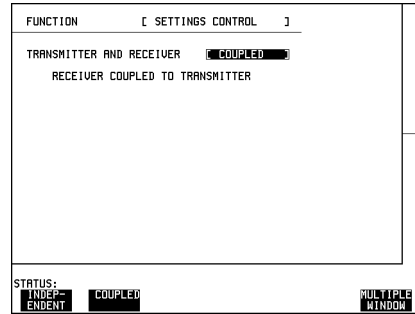

2. Connect the HP 37717C to the line equipment and set up the **TRANSMIT MAIN SETTINGS** display as shown opposite.

The settings of SIGNAL rate and LINE CODE must match those of the network equipment.

PAYLOAD TYPE selects the Framing which must match that of the network equipment.

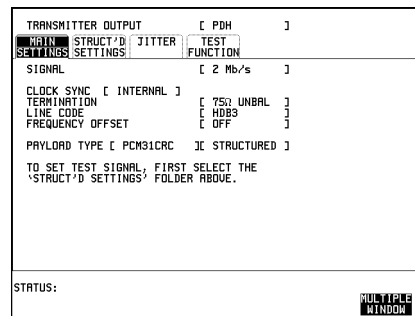

3. Set up the **TRANSMIT STRUCTURED SETTINGS** display as shown opposite.

In this example timeslots 3, 5, 9, 25, 26 and 27 are selected.



PDH / DSn Testing  
**Analysis of N x 64 kb/s**

4. Set up the **RESULTS** display as shown opposite.

The RESULTS type may be changed during the measurement without interrupting the test.

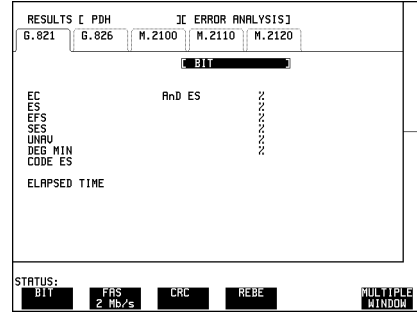

**HP 37717C #2**

1. Set up the **OTHER SETTINGS CONTROL** display as shown opposite.

Any settings change made on the **TRANSMIT** or **RECEIVE** displays will automatically occur on the other.

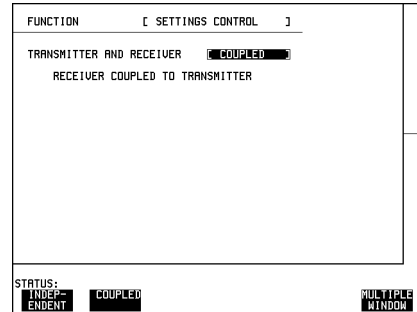

2. Set up the **RECEIVE MAIN SETTINGS** display as shown opposite.

The settings of SIGNAL rate and LINE CODE must match those of the network equipment.

PAYLOAD TYPE selects the Framing which must match that of the network equipment.

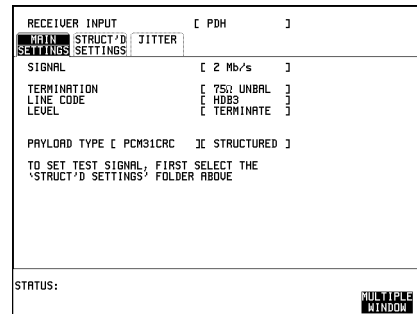

## PDH / DS<sub>n</sub> Testing Analysis of N x 64 kb/s

3. Set up the **RECEIVE STRUCTURED SETTINGS** display as shown opposite.

In this example timeslots 3, 5, 9, 25, 26 and 27 are selected.



4. Set up the **RESULTS** display as shown opposite.

The RESULTS type may be changed during the measurement without interrupting the test.

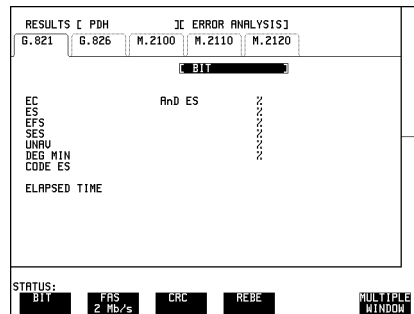

### Run the Test (N x 64 kb/s Analysis)

1. Press **RUN/STOP**.

- The measurement results and alarms are available on the **RESULTS** display during the test period.
- The test can be halted at any time by pressing **RUN/STOP**.

## **BERT Testing**

**Options Required** Structured PDH **UKJ (USA)**, DS1,DS3,E1, E3 structured PDH **110** or Unstructured PDH **UKK (USB)**

### **Application**

A transmission system must be specified for its overall error performance, measured over a period of time. Conformance to these specifications ensures that an installed system will meet the requirements of an Integrated Digital Network (IDN).

After troubleshooting, or during installation or commissioning, it is necessary to check that the transmission link meets this error performance.

This can be performed in two ways:

- End To End - Error performance measurements are made on an end-to-end basis testing the Go and Return paths separately but simultaneously. The measurements are often performed unattended and the results and other events, alarms for example, logged on a printer or disc and timed by a real time clock facility.

Two HP 37717C's are required for this measurement, one at each end of the link.

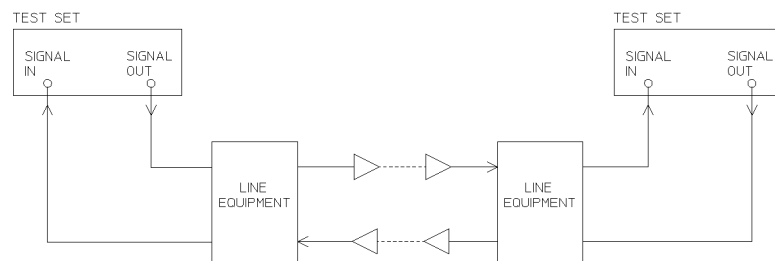

### **End-to End Test**



## PDH / DSn Testing

### BERT Testing

- Loopback - Error performance measurements are made via a loopback at the remote end of the system testing the combined Go and Return paths. The measurements are often performed unattended and the results and other events, alarms for example, logged on a printer or disc and timed by a real time clock.

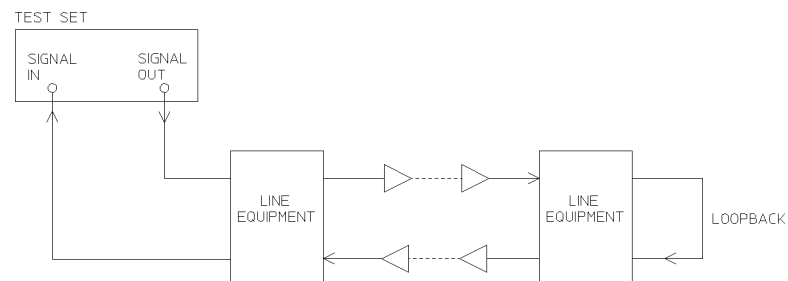

### Loopback Test

#### Default (Known State) Settings

It can be advisable to set the HP 37717C to a known state prior to setting up to make a measurement. This clears all previous settings and provides a clearly defined instrument state. Select **OTHER**, **STORED SETTINGS** .set STORED SETTINGS NUMBER to 0 and ACTION to **RECALL** .

#### Test Setup Procedure (BERT Testing)

This setup procedure is based on 140 Mb/s, CMI, PRBS test data terminated in  $75\Omega$ . A SINGLE test period of 24 HOURS is used and use of the a printer or disc for recording of results and alarms is included. A graphical record of the results can be viewed on the HP 37717C **GRAPH** display at the end of the test period.

PDH / DS<sub>n</sub> Testing  
**BERT Testing**

1. Set up the **OTHER SETTINGS CONTROL** display as shown opposite (on both HP 37717C's if end to end).

Any settings change made on the **TRANSMIT** or **RECEIVE** displays will automatically occur on the other.

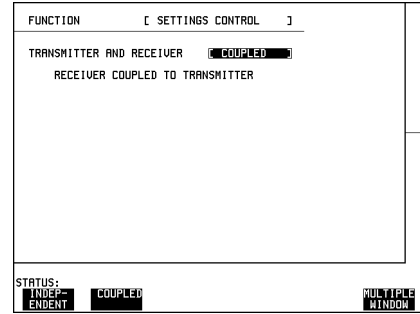

2. Connect the HP 37717C to the line equipment and set up the **TRANSMIT** display as shown opposite (on both HP 37717C's if end to end).

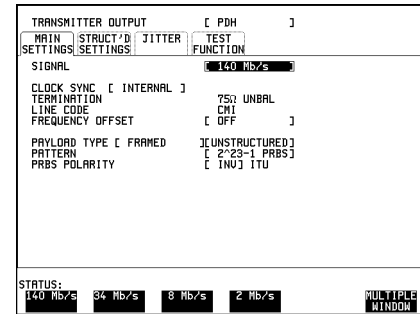

3. Select the **LOGGING** function as shown opposite (on both HP 37717C's if end to end).

A LOGGING PERIOD selection of [USER PROGRAM] [10 MIN] provides the following:

A complete set of period and a complete set of cumulative results logged on the printer or disc every 10 minutes.

A complete set of cumulative results logged on the printer or to disc at the end of the test period.

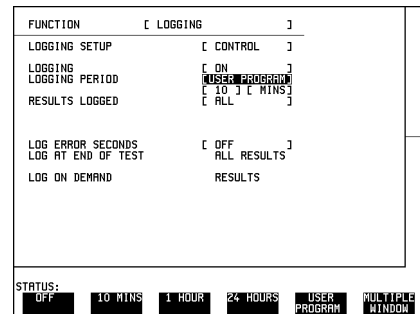

## PDH / DSn Testing

### BERT Testing

4. Set the **RESULTS** **TIMING CONTROL** as shown opposite (on both HP 37717C's if end to end).

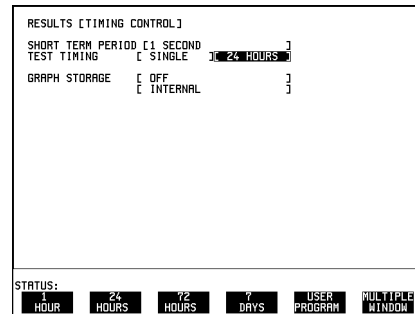

5. Select the **RESULTS** **PDH RESULTS** **ERROR ANALYSIS** display

The RESULTS type displayed can be changed during the test period without interrupting the test.

The RESULTS **TIMING CONTROL** STORAGE selection enables the graphics. To disable graphics select STORAGE [OFF].

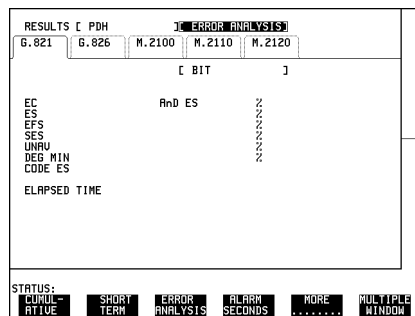

#### Start the Test (BERT Testing)

1. Press **RUN/STOP** (on both HP 37717C's if end to end).

The measurement results and alarms are available on the **RESULTS** display during the test period.

The graphical measurement results and alarms are stored in non volatile memory for viewing later on the **GRAPH** display.

The test can be halted at any time by pressing **RUN/STOP**.

#### At the End of the Test (BERT Testing)

- The Date and Time the test started and the instrument setup are logged on the selected logging device.
- All results are logged on the selected logging device at 10 minute intervals.
- Any alarms which occur during the test period will be logged on a printer or disc.
- At the end of the test period a complete set of cumulative results are logged on the printer or disc.
- A graphical record of the results during the test period can be viewed on the

## PDH / DSn Testing

### BERT Testing

**GRAPH** display. If Remote Control option A3B or A3D is fitted the graph results can be logged to an external printer, at a later date.

- Results and Alarm summaries can be viewed on the **GRAPH** display.

The total graphics store capacity is normally 20,000 events. If GRAPH STORAGE RESOLUTION [FULL] is selected on the **OTHER MISCELLANEOUS** display the capacity reduces to 10,000 events.

The resolution, determined by the selection made under STORAGE on the **RESULTS TIMING CONTROL** display, affects the ZOOM capability when viewing the bar graphs. If 1 SECOND is selected all resolutions are available under ZOOM. If 1 MIN is selected only 1 MIN/BAR, 15 MINS/BAR and 60 MINS/BAR are available. If 15 MINS is selected only 15 MINS/BAR and 60 MINS/BAR are available. If 1 HOUR is selected only 60 MINS/BAR is available.

Up to 10 sets of graphical results can be stored. If an attempt is made to store more than 10 sets of results, then a first in first out policy is operated and the oldest set of results will be lost. If graphics are enabled and a test is run which exceeds the remaining storage capacity, then some previously stored graphical results will be lost.

To prevent accidental overwriting of previously stored results the graphics capability should be disabled, when graphical results are not required, by selecting STORAGE [OFF] on the **RESULTS TIMING CONTROL** display.

## **Cross Multiplexer Testing**

**Option Required** Structured PDH UKJ (USA), DS1, DS3, E1, E3 structured PDH  
**110**

### **Application**

For comprehensive testing of network equipment it is essential that the test equipment can multiplex/demultiplex the test signal.

The insertion of tributary signals into the PDH multiplexer, which are then multiplexed into the 140 Mb/s PDH structure should take place without introducing errors. The insertion and structuring process is tested by adding a test pattern to the tributary inserted at the tributary insert port. At the high rate side of the PDH multiplexer the tributary is destructured and a BER test performed.

By using a protected monitor point at the high rate side of the PDH multiplexer the mux/demux need not be taken out of service.

### **Default (Known State) Settings**

It is advisable to set the HP 37717C to a known state before setting up a measurement. This clears all previous settings and provides a clearly defined instrument state. Select **OTHER**, **STORED SETTINGS**, set STORED SETTINGS NUMBER to 0 and ACTION to **RECALL**.

### **Cross Multiplexer Testing Test Setup Procedure**

In this setup a 2 Mb/s Framed tributary, containing a test pattern, is inserted at the tributary insert port of the PDH multiplexer. The 140 Mb/s structured PDH signal is obtained from a protected monitor point. The 2 Mb/s tributary is destructured by the HP 37717C test set and an Error measurement is performed on the 2 Mb/s tributary test pattern.

A SINGLE test period of 24 HOURS is used and the printer is enabled to record results and alarms.

The HP 37717C PDH/SDH test set GRAPHICS function is enabled. The graphical results can be viewed on the **GRAPH** display.

PDH / DS<sub>n</sub> Testing  
**Cross Multiplexer Testing**

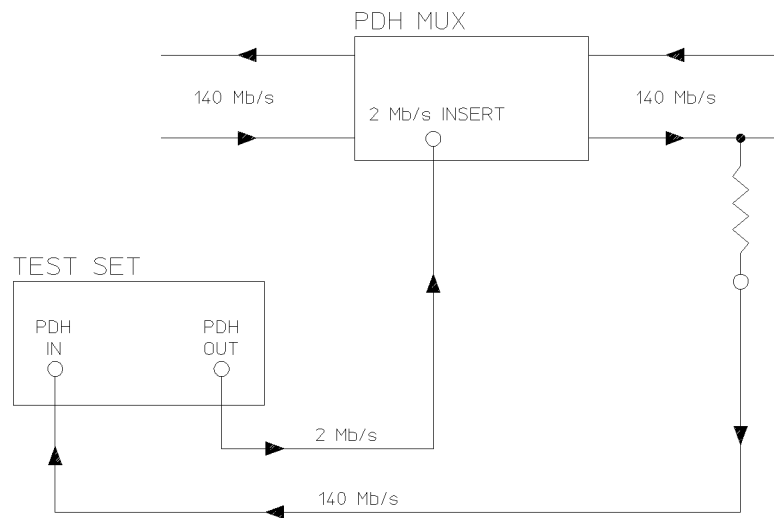

**Cross Multiplexer Testing**

1. Connect the HP 37717C to the network equipment and set up the **OTHER SETTINGS CONTROL** display as shown opposite.

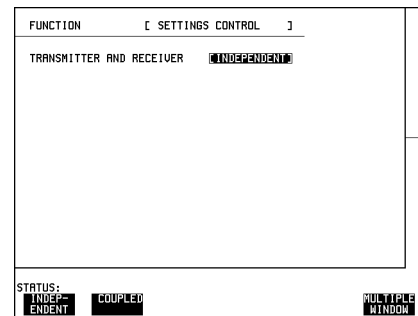

## PDH / DS<sub>n</sub> Testing

### Cross Multiplexer Testing

2. Set up the **TRANSMIT** display as shown opposite.

The PAYLOAD TYPE determines the Framing, which is selected from the softkey menu.

Selections of Framing and Code must match those of the network equipment.

TRANSMITTER OUTPUT [ PDH ]	
MAIN	STRUCT'D
SETTINGS	FUNCTION
SIGNAL [ 2 Mb/s ]	
CLOCK SYNC [ INTERNAL ]	
TERMINATION [ 75Ω UNBAL ]	
LINE CODE [ HDB3 ]	
FREQUENCY OFFSET [ OFF ]	
PAYLOAD TYPE [ <b>PCM31CRC</b> ]	[ UNSTRUCTURED ]
PATTERN [ 2 <sup>11</sup> -1 PRBS ]	
PRBS POLARITY [ INU ]	[ ITU ]
STATUS:	
UNFRAMED	MULTIPLE WINDOW

3. Set up the **RECEIVE** display **MAIN SETTINGS** as shown opposite.

The GAIN and EQUALIZER settings should be set to optimize the received signal.

RECEIVER INPUT [ PDH ]	
MAIN	STRUCT'D
SETTINGS	FUNCTION
SIGNAL [ 140 Mb/s ]	
TERMINATION [ 75Ω UNBAL ]	
LINE CODE [ C41 ]	
LEVEL [ MONITOR ]	
EQUALIZER [ OFF ]	GAIN [ 20 dB ]
PAYLOAD TYPE [ FRAMED ]	
TO SET TEST SIGNAL, FIRST SELECT THE 'STRUCT'D SETTINGS' FOLDER ABOVE	
STATUS:	
	MULTIPLE WINDOW

4. Set up the **RECEIVE** display **STRUCTURED SETTINGS** as shown opposite.

The required 2 Mb/s test signal is selected under 34Mb: 8Mb: 2Mb

2M Payload determines the test signal framing and must match that of the network equipment.

RECEIVER INPUT [ PDH ]	
MAIN	STRUCT'D
SETTINGS	FUNCTION
TEST SIGNAL [ 2 Mb/s ]	
2M PAYLOAD [ <b>PCM31CRC</b> ]	
34Mb [ 2 ]	8Mb [ 4 ]
PATTERN [ 2 <sup>11</sup> -1 PRBS ]	
PRBS POLARITY [ NORM ]	[ CCITT ]
STATUS:	
1	2
3	4
	MULTIPLE WINDOW

PDH / DSn Testing  
**Cross Multiplexer Testing**

5. Select the logging device and set up the **OTHER** display, **LOGGING** function, as shown opposite.

WHEN [PERIOD EC>0] ensures results are not logged on the selected logging device when a print period is error free.

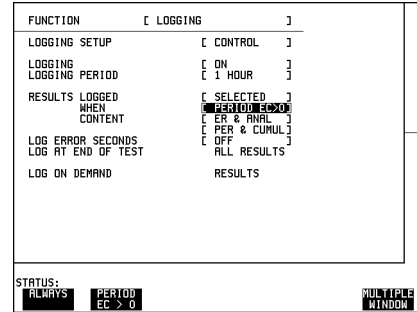

**Continuity Check**

Before running the test carry out a continuity test to verify the measurement path.

1. Set up the **RESULTS** display as shown opposite.
2. Press **RUN/STOP** to start a measurement.
3. Press error add **SINGLE** three times and check that the errors are recorded on the **RESULTS** display.
4. Press **RUN/STOP** to stop the measurement.

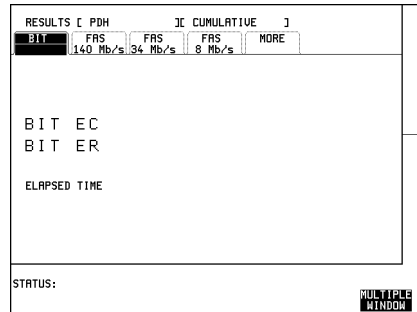

**Start the Cross Multiplexer Test**

5. Set the **RESULTS TIMING CONTROL** as shown opposite.

If you do not require stored graphics results select STORAGE [OFF].

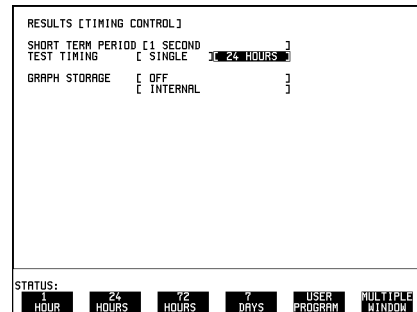



## PDH / DSn Testing

### Cross Multiplexer Testing

6. Press **RUN/STOP** to start the measurement.

G.821 Analysis results are displayed but any of the other results can be viewed without affecting the measurement.

The following error results are available on the **RESULTS** display during the test period:

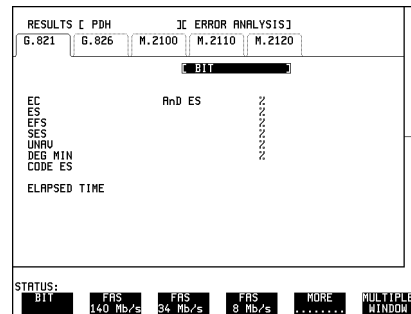

- 2 Mb/s - FAS, CRC, REBE and BIT
- 8, 34 and 140 Mb/s - FAS

The graphical measurement results and alarms are stored in non volatile memory for viewing later on the **GRAPH** display.

The test can be halted at any time by pressing **RUN/STOP**.

#### At the End of the Test (Cross Multiplexer Testing)

- The Date and Time the test started and the instrument set-up are logged on the logging device selected.
- Results are logged on the selected logging device at 1 hour intervals if the error count is greater than 0.
- Any alarms which occur during the test period will be logged on the selected logging device.
- At the end of the test period a complete set of cumulative results are logged on the selected logging device.
- A graphical record of the results during the test period can be viewed on the **GRAPH** display. If Remote Control option A3B or A3D is fitted the graph results can be logged to an external printer, at a later date.
- Results and Alarm summaries can be viewed on the **GRAPH** display.

## PDH / DSn Testing

### Cross Multiplexer Testing

The total graphics store capacity is normally 20,000 events. If GRAPH STORAGE RESOLUTION [FULL] is selected on the **OTHER** **MISCELLANEOUS** display the capacity reduces to 10,000 events.

The resolution, determined by the selection made under STORAGE on the **RESULTS** **TIMING CONTROL** display, affects the ZOOM capability when viewing the bar graphs. If 1 SECOND is selected all resolutions are available under ZOOM. If 1 MIN is selected only 1 MIN/BAR, 15 MINS/BAR and 60 MINS/BAR are available. If 15 MINS is selected only 15 MINS/BAR and 60 MINS/BAR are available. If 1 HOUR is selected only 60 MINS/BAR is available.

Up to 10 sets of graphical results can be stored. If an attempt is made to store more than 10 sets of results, then a first in first out policy is operated and the oldest set of results will be lost. If graphics are enabled and a test is run which exceeds the remaining storage capacity, then some previously stored graphical results will be lost.

To prevent accidental overwriting of previously stored results the graphics capability should be disabled, when graphical results are not required, by selecting STORAGE [OFF] on the **RESULTS** **TIMING CONTROL** display.

## **FAS Monitoring**

**Options Required** Structured PDH **UKJ (USA)**, DS1, DS3, E1, E3 structured PDH **110** or Unstructured PDH **UKK (USB)**

---

### **NOTE**

---

Option UKK (USB) - Unstructured PDH allows FAS Monitoring to be carried out at 2, 8, 34 and 140 Mb/s.  
Application

Degradation in error performance can be detected by the occurrence of Frame Alignment Signal (FAS) errors in PDH /DS<sub>n</sub> systems.

Using the HP 37717C in a *receive only* mode, FAS errors can be measured and viewed on the **RESULTS** display. In addition, the results can be logged on the selected logging device for examination later.

### **Default (Known State) Settings**

It can be advisable to set the HP 37717C to a known state prior to setting up to make a measurement. This clears all previous settings and provides a clearly defined instrument state. Select **OTHER**, **STORED SETTINGS**, set STORED SETTINGS NUMBER to 0 and ACTION to **RECALL**.

### **Test Setup Procedure (FAS Monitoring)**

This setup procedure is based on Structured PDH 140 Mb/s line traffic interfaced at the line equipment protected Monitor point. If a protected Monitor Point is not available then an HP 15510A Protective Probe may be used at an unprotected Monitor point.

The instrument is used in a *receive only* mode to measure FAS Errors. A Timed Start test period is used which allows the measurement to be started at a time when the user would not normally be available.

All Error Ratio and Analysis results are logged on the selected logging device at 2 hour intervals and at the end of the test period. Occurrences of error seconds and alarms are logged on the selected logging device in real time.

PDH / DS<sub>n</sub> Testing  
**FAS Monitoring**

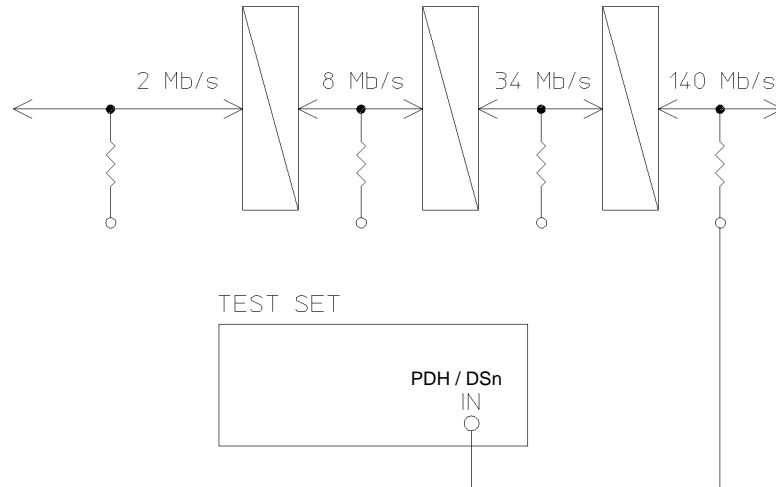

**FAS Monitoring**

1. Connect the HP 37717C to the line terminal equipment protected Monitor point and set up the **RECEIVE** display **MAIN SETTINGS** as shown opposite.

When Balanced FAS monitoring is desired at an unprotected Monitor point use an HP 15511A Protective Monitor Probe.

The GAIN and EQUALIZER settings should be set to optimize the received signal.

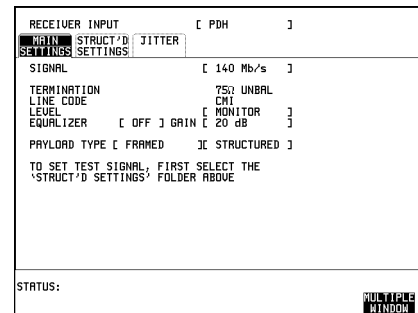

PDH / DS<sub>n</sub> Testing  
**FAS Monitoring**

2. Set up the **RECEIVE** display  
**STRUCTURED SETTINGS** as shown  
 opposite.

2M PAYLOAD Framing selection should  
 match that of the network equipment.

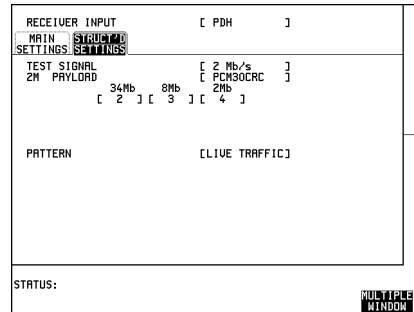

3. Set up the **OTHER LOGGING**  
 display as shown opposite.

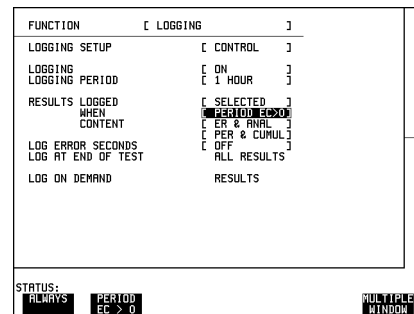

**Start the Test (FAS Monitoring)**

4. Set the **RESULTS TIMING CONTROL**  
 as shown opposite.

The test period will begin at the START  
 time selected on this display.

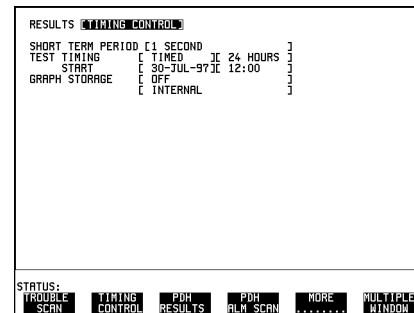

## PDH / DSn Testing

### FAS Monitoring

5. Set up the **RESULTS** PDH display as shown opposite.

The following error types can be monitored:

140 Mb/s - FAS (Short Term, Cumulative and G.821 Analysis)

34 Mb/s - FAS (Short Term, Cumulative and G.821 Analysis)

8 Mb/s - FAS (Short Term, Cumulative and G.821 Analysis)

2 Mb/s - FAS, CRC and REBE (Short Term, Cumulative and G.821 Analysis)

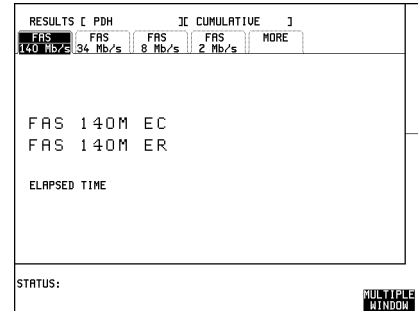

- Any occurrence of Alarms or Error Seconds during the test period are logged on the selected logging device.
- Cumulative and Period versions of Error Results and Analysis Results are logged on the selected logging device at 1 hour intervals.
- The test can be halted at any time by pressing **RUN/STOP**.

#### At the End of the Test

Cumulative and Period versions of Error Results and Analysis Results are logged on the selected logging device.

## Frequency Measurement

### Options Required

If measuring frequency at PDH rates one of the following options is required.

Structured PDH **UKJ (USA)** or **UKN (USE)**, or DS1, DS3, E1, E3 structured PDH **110**, or Unstructured PDH **UKK (USB)**

If measuring frequency at SDH rates the following options must be fitted:

- For STM-0/1 electrical interfaces: A3R [A3S].
- For STM- Optical Interfaces: A3R and UH1.
- For STM-0/1/4 Optical Interfaces: A3R and 130 (1310 and 1550nm) or 131 (1310nm).

### Application

The clock frequency and the amount of offset from the ITU standard rate can be measured to give an indication of probability of errors. The measurement can be made in out of service or monitor mode and is generally of short duration.

### Default (Known State) Settings

It can be advisable to set the HP 37717C to a known state prior to setting up to make a measurement. This clears all previous settings and provides a clearly defined instrument state. Select **OTHER**, **STORED SETTINGS** set STORED SETTINGS NUMBER to 0 and ACTION to **RECALL**.

### Test Setup Procedure (Frequency Measurement)

If measuring on live traffic the measurement is interfaced at the line terminal equipment Monitor point.

The HP 37717C is used in a *receive only* mode to measure the PDH / DS<sub>n</sub> frequency. The PDH / DS<sub>n</sub> frequency is measured and compared with the internal ITU standard frequency selected

## PDH / DS<sub>n</sub> Testing Frequency Measurement

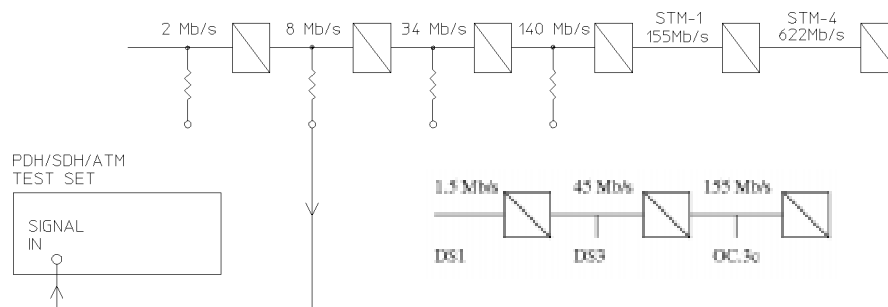

Figure 1

### Frequency Measurement

1. Select SIGNAL [8 Mb/s] on the **RECEIVE** display.

For frequency measurement PATTERN; TERMINATION and CODE are not relevant.

RECEIVER INPUT	[ PDH ]
SIGNAL	[ 8 Mb/s ]
LEVEL	[ MONITOR ]
TEST MODE	[ OUT OF SRUC ]
CODE	[ HDB3 ]
PATTERN	[ 2 <sup>15</sup> -1 ]
TERMINATION	75Ω UNBAL

STATUS: 140 Mb/s 34 Mb/s 8 Mb/s 2 Mb/s 704 kb/s MULTIPLE WINDOW

2. Select **RESULTS** **PDH** **FREQUENCY**.

RESULTS [ PDH ]	[ FREQUENCY ]
1 SEC	16 SEC
FREQUENCY	Hz
OFFSET	Hz
	ppm

STATUS: MULTIPLE WINDOW SHORT TERM ERROR ANALYSIS ALARM SECONDS FREQ- UENCY MULTIPLE WINDOW



## PDH / DSn Testing Frequency Measurement

### Run the Test (Frequency Measurement)

Connect the PDH / DSn IN port to the line terminal equipment monitor point.

The measured frequency and amount of offset from the internal standard is displayed.

If the PDH / DSn frequency is different from the selected BIT RATE the error message **Unable to recover clock** appears on the display. A **FREQ** reading is displayed but this should be ignored.

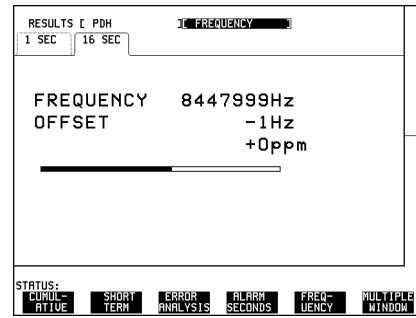

### At the End of the Test (Frequency Measurement)

Disconnect the HP 37717C from the line terminal equipment.

## **Frequency Offset Tolerance**

### **Options Required**

If checking frequency offset tolerance at PDH /DS<sub>n</sub> rates one of the following options is required.

- UKJ (USA) or UKK (USB) or 110 - Modules with PDH capability

If checking frequency offset tolerance at SDH rates one of the following options must be fitted:

- A3R [A3S] - SDH Module
- A3R and UH1 (STM-1 Optical Interface)
- A3R and 130 or 131 - STM-0/1/4 Optical Interface

### **Application**

The capability of the network equipment to reliably recover the clock is tested by varying the clock rate of the generated data and checking for the occurrence of transmission errors.

The measurement can be made via a loopback or in a cross-multiplexer configuration, and is generally of short duration.

The ITU G.703 Recommendation for Clock Tolerance is:

- DS1 1.544 Mb/s  $\pm$  32 ppm
- E1 2.048 Mb/s  $\pm$  50 ppm
- E2 8.448 Mb/s  $\pm$  30 ppm
- E3 34.368 Mb/s  $\pm$  20 ppm
- DS3 44.736 Mb/s  $\pm$  20 ppm
- E4 139.264 Mb/s  $\pm$  15 ppm

In SDH systems if the master timing reference is lost a standby reference within 20 ppm can be used for a limited time:

- STM-1 155.520 Mb/s  $\pm$  20 ppm
- STM-4 622.080 Mb/s  $\pm$  20 ppm.

## PDH / DS<sub>n</sub> Testing Frequency Offset Tolerance

### Default (Known State) Settings

It can be advisable to set the HP 37717C to a known state prior to setting up to make a measurement. This clears all previous settings and provides a clearly defined instrument state. Select **OTHER**, **STORED SETTINGS**, set STORED SETTINGS NUMBER to 0 and ACTION to **RECALL**.

### Test Setup Procedure (Frequency Offset Tolerance)

This setup procedure tests the clock recovery capability of the line terminal equipment at 34 Mb/s using a PRBS pattern connected to the 75Ω interface. The frequency of the generated data is offset and the data is looped back and monitored for errors.

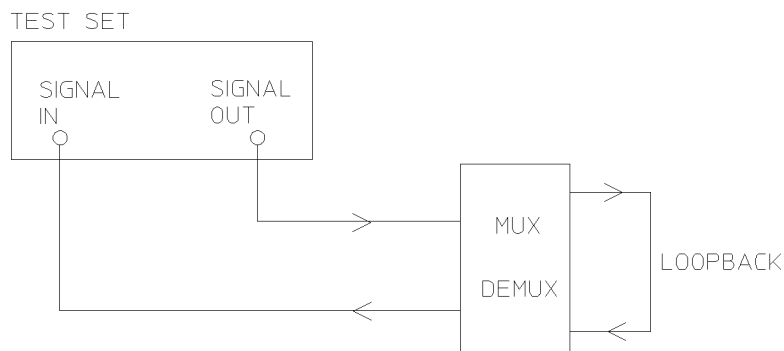

**Figure 2** Frequency Offset Tolerance Test

1. Set up the **OTHER SETTINGS CONTROL** display as shown below.

Any settings change made on the **TRANSMIT** or **RECEIVE** displays will automatically occur on the other.

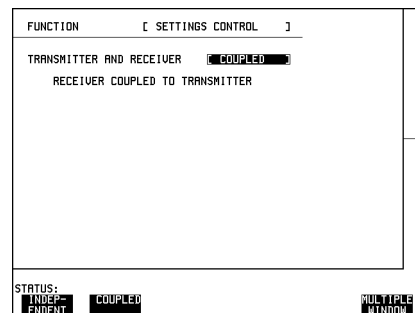

## PDH / DS<sub>n</sub> Testing Frequency Offset Tolerance

2. Set up the **RECEIVE** display as shown opposite.

Select the PATTERN required from the menu.

RECEIVER INPUT	[ PDH ]
MAIN STRUCT'D	JITTER
SETTINGS SETTINGS	
SIGNAL	[ 34 Mb/s ]
TERMINATION	75Ω UNBAL
LINE CODE	HDB3
LEVEL	[ TERMINATE ]
PAYLOAD TYPE [ UNFRAMED ]	UNSTRUCTURED
PATTERN	[ 2 <sup>15</sup> -1 PRBS ]
PRBS POLARITY	[ INV ] ITU
STATUS:	
	MULTIPLE WINDOW

3. Set the **RESULTS TIMING CONTROL** as shown opposite.

RESULTS	TIMING CONTROL
SHORT TERM PERIOD [ 1 SECOND ]	
TEST TIMING [ TIMED ]	[ 24 HOURS ]
START [ 30-JUL-97 ]	[ 12:00 ]
GRAPH STORAGE [ OFF ]	
	[ INTERNAL ]
STATUS:	
TROUBLE SCAN	TIMING CONTROL
PDH RESULTS	PDH ALM SCAN
MORE	MULTIPLE WINDOW

4. Select the **RESULTS** PDH Results display.

Any of the other results can be selected without affecting the measurement.

RESULTS [ PDH ]	[ CUMULATIVE ]
BIT EC	
BIT ER	
CODE EC	
CODE ER	
ELAPSED TIME	
STATUS:	
TROUBLE SCAN	SHORT TERM
ERROR ANALYSIS	ALARM SECONDS
FREQ- UENCY	MULTIPLE WINDOW

### Continuity Check

Before running the test carry out a continuity test to verify the measurement path.

1. Connect a loopback at the desired point on the line terminal or cross-multiplexer equipment.

2. Press **RUN/STOP** to start a measurement.

## PDH / DS<sub>n</sub> Testing

### Frequency Offset Tolerance

3. Press error add **SINGLE** three times and check that the errors are recorded on the **RESULTS** display.
4. Press **RUN/STOP** to stop the measurement.

### Run the Test (Frequency Offset Tolerance)

1. Connect the HP 37717C to the 75 $\Omega$  interface of the multiplexer and set up the **TRANSMIT** display as shown opposite.
2. Press **RUN/STOP** to start the measurement.

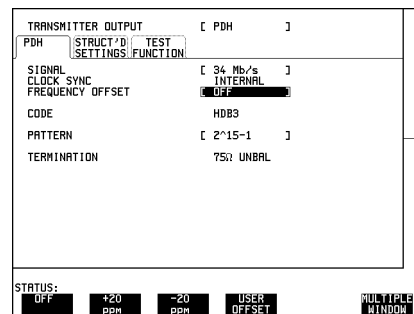

3. Select TX CLOCK OFFSET [+20ppm] and check that the Error Count and Error Ratio results are unchanged.
4. Select TX CLOCK OFFSET [-20ppm] and check that the Error Count and Error Ratio results are unchanged.

### NOTE

The OFFSET values used above conform to ITU, G.703 Recommendation. If different values are required selection of [USER OFFSET] allows offsets of up to 100 ppm to be used.

### At the End of the Test

1. Halt the test by pressing **RUN/STOP**, and disconnect the HP 37717C.
2. Remove the loopback from the line terminal or cross-multiplexer equipment.

## **Multiplexer Testing**

### **Application**

PDH multiplexers combine four lower rate signals into a higher rate signal for transmission or further multiplexing. It is important that each multiplexer port operates error free and no "crosstalk" occurs between ports.

Multiplexing of the tributaries can be verified by performing a BER test at each of the four ports. However a more rigorous test involves loading all four ports to simulate live traffic conditions. This verifies the individual ports and detects any crosstalk problems between the ports.

### **Default (Known State) Settings**

It is advisable to set the HP 37717C to a known state before setting up a measurement. This clears all previous settings and provides a clearly defined instrument state. Select **OTHER**, **STORED SETTINGS**, set STORED SETTINGS NUMBER to 0 and ACTION to **RECALL**.

### **Multiplexer Test Setup Procedure**

The following Options must be fitted to the HP 37717C to perform this test:

- UHC (US6) - Multiple Outputs
- UKJ (USA) or UKK (USB) or 110 - PDH Module

In this setup the PDH OUT signal and the three additional data outputs, from the Multiple Outputs option, load the 34 Mb/s input ports of the multiplexer. The HP 37717C (Structured PDH Option UKJ (USA)) destructures the 140 Mb/s signal and a BER test is performed on each of the 34 Mb/s signals in turn.

A SINGLE test period of 15 Minutes is used and the selected logging device is enabled to record results and alarms.

PDH / DS<sub>n</sub> Testing  
**Multiplexer Testing**

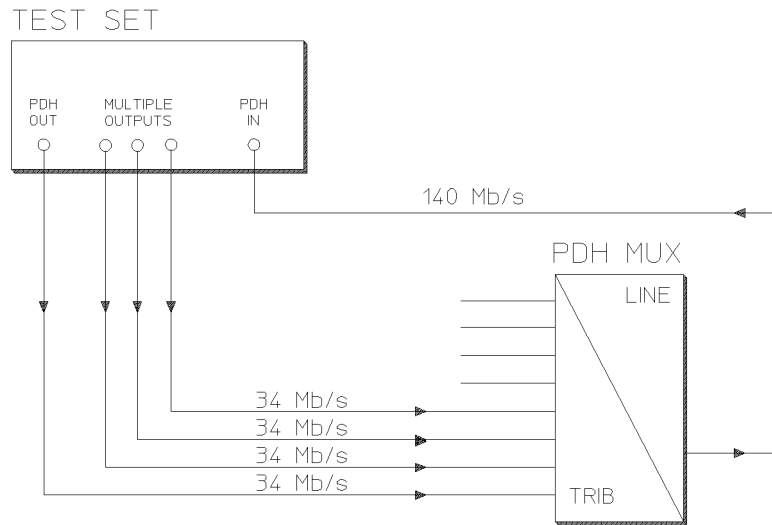

**Figure 3**      **Structured PDH Multiplexer Test**

**NOTE**      This test can be performed using the Unstructured PDH Option UKK (USB) but the equipment configuration is slightly different as shown below.

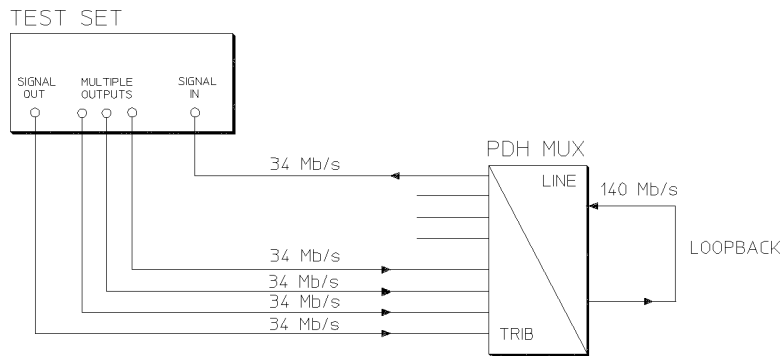

**Figure 4**      **Unstructured PDH Multiplexer Test**

## PDH / DS<sub>n</sub> Testing Multiplexer Testing

1. Connect the HP 37717C to the network equipment and set up the **OTHER** **SETTINGS CONTROL** display as shown opposite.

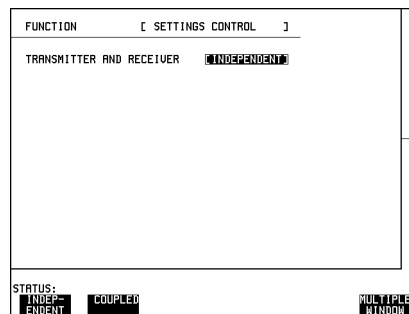

2. Set up the **TRANSMIT** display **MAIN SETTINGS** as shown opposite. PAYLOAD TYPE, PATTERN and PRBS POLARITY selections should meet the requirements of the network equipment.

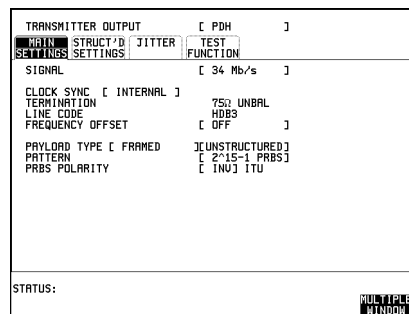

3. Set up the **RECEIVE** display MAIN SETTINGS as shown below. PAYLOAD TYPE [STRUCTURED] ensures the 140 Mb/s signal is deconstructed into the four 34 Mb/s test signals

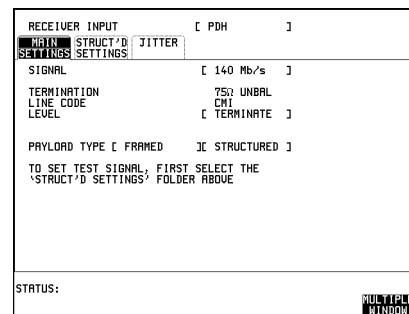



## PDH / DSn Testing Multiplexer Testing

4. Set up the **RECEIVE** display  
**STRUCTURED SETTINGS** as shown  
opposite.

The required 34 Mb/s test signal is  
selected under 34Mb.

RECEIVER INPUT	[ PDH ]
MAIN SETTINGS	<b>STRUCTURED SETTINGS</b>
TEST SIGNAL	[ 34 Mb/s ]
34M PAYLOAD	[ FRAMED ]
	34Mb
	[ 3 ]
PATTERN	[ 2 <sup>15</sup> -1 PRBS ]
PRBS POLARITY	[ INU ] CCITT
STATUS:	
<b>MULTIPLE WINDOW</b>	

5. Select the logging output required with  
the **OTHER** display, **LOGGING**  
function, LOGGING SETUP **DEVICE**  
then select LOGGING SETUP  
**CONTROL** and set up the display as  
shown opposite.

FUNCTION	[ LOGGING ]
LOGGING SETUP	[ CONTROL ]
LOGGING PERIOD	[ ON ]
	[ OFF ]
LOG ERROR SECONDS	[ OFF ]
LOG AT END OF TEST	[ ALL RESULTS ]
LOG ON DEMAND	RESULTS
STATUS:	
[ OFF ]	[ ON ]
<b>MULTIPLE WINDOW</b>	

### Start the Multiplexer Test

6. Set the **RESULTS** **TIMING CONTROL**  
as shown opposite.

RESULTS (TIMING CONTROL)	
SHORT TERM PERIOD (1 SECOND)	[ SINGLE ]
TEST TIMING	[ 1.00 ]
GRAPH STORAGE	[ OFF ]
	[ INTERNAL ]
STATUS:	

## PDH / DSn Testing Multiplexer Testing

7. Set up the **RESULTS** display as shown opposite.

8. Press **RUN/STOP** to start the measurement.

9. Repeat the test for the other three 34 Mb/s signals, selectable on the **RECEIVE STRUCTURED SETTINGS** display.

G.821 ANALYSIS is selected but any of the other results can be selected from the softkey menu without affecting the measurement.

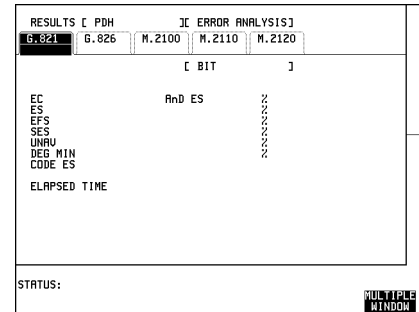

- The measurement results and alarms are available on the **RESULTS** display during the test period.
- The test can be halted at any time by pressing **RUN/STOP**.

### At the End of the Multiplexer Test

- The Date and Time the test started and the instrument setup are logged on the selected logging device.
- All results are logged on the selected logging device at the end of the test.
- Any alarms which occur during the test period will be logged on the selected logging device.

---

## Round Trip Delay

### Application

In certain applications the time taken for a signal to pass through the network can be very important for example Voice Traffic where excessive delay can make speech difficult to understand. The Round Trip delay feature of the HP 37717C allows measurement of the delay at any interface or test signal rate.

### Default (Known State) Settings

It can be advisable to set the HP 37717C to a known state prior to setting up to make a measurement. This clears all previous settings and provides a clearly defined instrument state. Select **OTHER**, **STORED SETTINGS**, set STORED SETTINGS NUMBER to 0 and ACTION to **RECALL**.

### Test Setup Procedure (Round Trip Delay)

The following Option must be fitted to the HP 37717C to perform this test:

- UKJ (USA) or 110 - Structured PDH Module

This setup is interfaced at 140 Mb/s with a test signal of 64 kb/s. A test pattern is transmitted in the 64 kb/s slot and a timer is set running. A loopback is applied to the network equipment to return the test signal. The received pattern stops the timer and the Round Trip Delay is calculated.

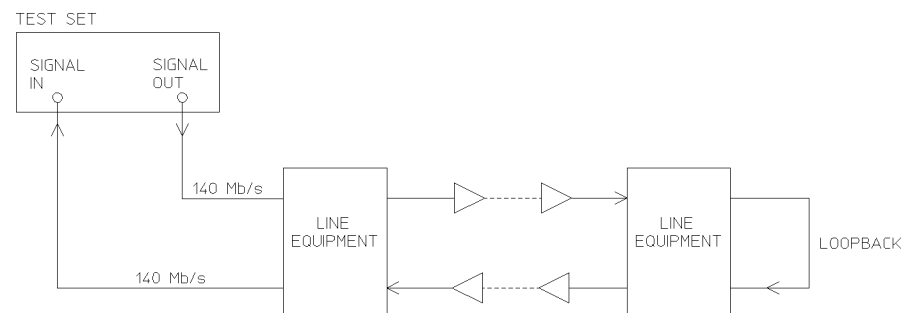

### Round Trip Delay

## PDH / DS<sub>n</sub> Testing Round Trip Delay

1. Connect the HP 37717C to the network equipment as shown and set up the **OTHER SETTINGS CONTROL** display as shown opposite.

Any settings change made on the **TRANSMIT** or **RECEIVE** displays will automatically occur on the other.

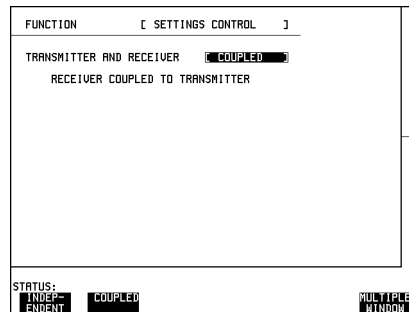

2. Set up the **TRANSMIT** display **MAIN SETTINGS** as shown opposite.

The SIGNAL rate and LINE CODE settings must match those of the network equipment.

Ensure that the **TRANSMIT** TEST FUNCTION display is set for bit errors.

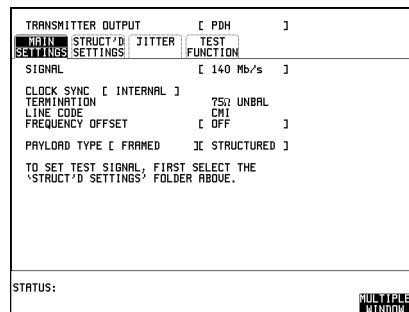

3. Set up the **TRANSMIT** display **STRUCTURED SETTINGS** as shown opposite.

The 2M PAYLOAD selection determines the Framing which should match that of the network equipment.

The test 64 kb/s slot is selected under 34Mb; 8Mb; 2Mb; 64kb.

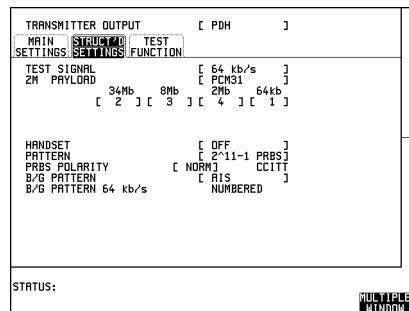

### Continuity Check

Before running the test carry out a continuity test to verify the measurement path.

## PDH / DS<sub>n</sub> Testing Round Trip Delay

1. Connect a loopback at the desired point on the line terminal equipment and set up the **RESULTS** display as shown opposite.
2. Press **RUN/STOP** to start a measurement.
3. Press error add **SINGLE** three times and check that the errors are recorded on the **RESULTS** display.
4. Press **RUN/STOP** to stop the measurement.

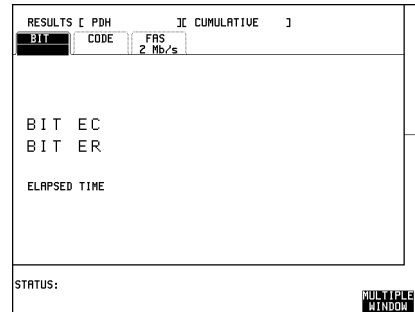

### Start the Test (Round Trip Delay)

5. Set the **RESULTS TIMING CONTROL** as shown opposite.

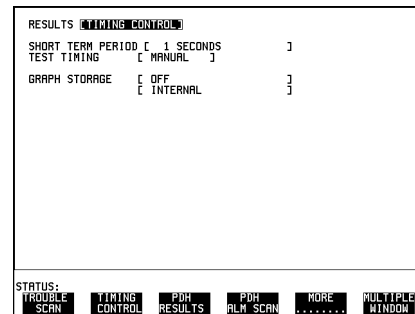

6. Select the **RESULTS PDH RESULTS TRIP DELAY** display.

Select ACTION **ON** to start the test.

The Round Trip Delay result is displayed in milliseconds.

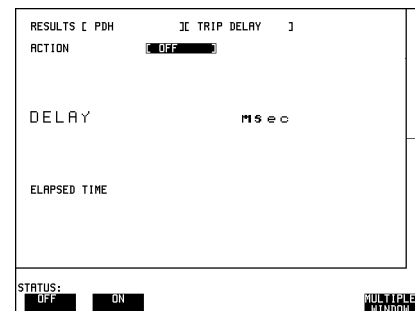

The delay measurement range is up to 2 seconds. The Resolution varies according to the received rate:

- 2 Mb/s - 1 $\mu$ s
- 8, 34, 140 Mb/s - 10 $\mu$ s
- STM-1 - 0.5 ms

---

## **M.2100, M.2110, M.2120 Analysis**

### **Application**

Previously ITU-T G.821 was the only international recommendation available to measure the quality of a communications link. ITU-T G.821 was originally an "Out of Service" measurement and analysis for commissioning a link and troubleshooting during severe disruption. The commissioning test was a one month "Out of Service" test based on errored and severely errored seconds. A one month test with the subsequent loss of revenue is clearly unacceptable.

Due to demand ITU-T G.821 also evolved into proprietary methods for "In Service" testing based on FAS and code errors. Demand for high quality leased lines meant an "In Service" performance standard, closer to real conditions and allowing comparisons between providers, was required.

The ITU-T M.2100 series was specifically defined to provide a clear indication of link quality, for service providers using long term performance analysis. "Bringing into Service" and "repair criteria" analysis were also included.

M.2100 analysis is based on frame errors and provides Error Seconds (anomaly), Severely Errored Seconds (defect) and Unavailability results for receive and transmit directions. Transmit results are only available for 2 Mb/s signals with CRC framing. "Out of Service" testing is only available for the receive direction. M.2110 is an "Out of Service" measurement for "bringing into service" testing of paths. A 15 minute BER test (G.821) is performed and if this is error free a 24 hour M.2110 test is performed. If the 24 hour M.2110 test displays PASS (S1 limit not reached) the path can be returned to service. If FAIL is displayed (S2 limit reached or exceeded) the 15 minute BER test should be repeated, If ? (UNCERTAIN) is displayed (result between the S1 and S2 limits) run the 7 day BIS test.

The PASS FAIL and UNCERTAIN parameters are determined by the S1 and S2 limits which are user selectable.

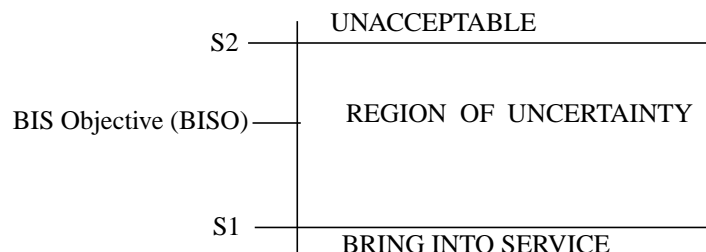

PDH / DS<sub>n</sub> Testing  
**M.2100, M.2110, M.2120 Analysis**

**Default (Known State) Settings**

It can be advisable to set the HP 37717C to a known state prior to setting up to make a measurement. This clears all previous settings and provides a clearly defined instrument state. Select **OTHER**, **STORED SETTINGS**, set STORED SETTINGS NUMBER to 0 and ACTION to **RECALL**.

**Test Setup Procedure M2110 Analysis**

The following Option must be fitted to the HP 37717C to perform this test:

- UKJ - Structured PDH Module

This setup procedure is interfaced at 140 Mb/s, with a test signal of 2 Mb/s with PCM30CRC framing.

1. Set up the **OTHER SETTINGS CONTROL** display as shown opposite.

Any settings change made on the **TRANSMIT** or **RECEIVE** displays will automatically occur on the other.

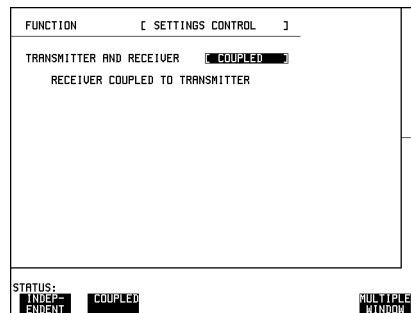

2. Connect the HP 37717C to the line equipment and set up the **TRANSMIT MAIN SETTINGS** display as shown opposite.

The settings of SIGNAL rate and LINE CODE must match those of the network equipment.

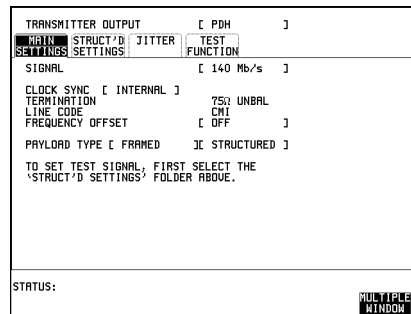

PDH / DS<sub>n</sub> Testing  
**M.2100, M.2110, M.2120 Analysis**

3. Set up the **TRANSMIT** display  
**STRUCTURED SETTINGS** as shown  
 opposite.

2M PAYLOAD selects the Framing which  
 must match that of the network equipment.

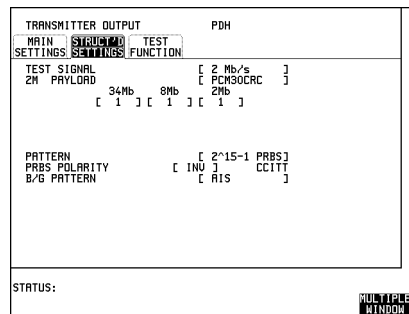

4. Set up the **RESULTS** display as shown  
 opposite.

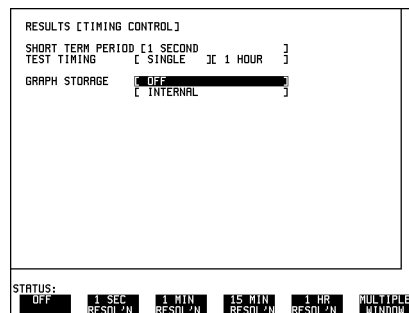

5. Press **RUN/STOP** to start the  
 measurement.

At the end of the test period check that the  
 G.821 results are error free.

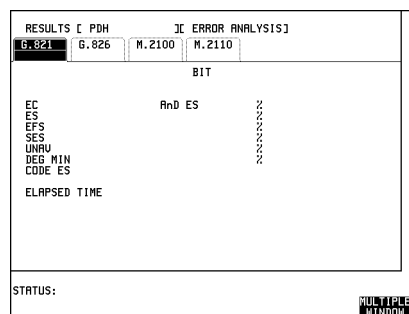



PDH / DSn Testing  
**M.2100, M.2110, M.2120 Analysis**

6. Set up the **RESULTS** display as shown opposite

Select the Path Allocation value required in the range 0.5% to 40%.

The Path Allocation value determines the S1 and S2 limits and these will change on the display as the Path Allocation value is changed.

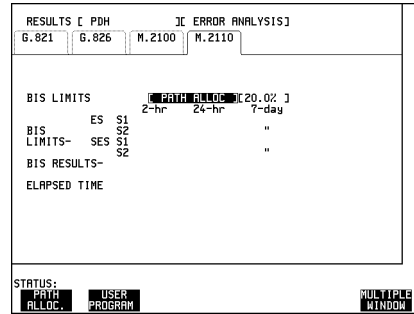

7. Set up the **RESULTS** display as shown opposite.

Press **RUN/STOP** to start the measurement.

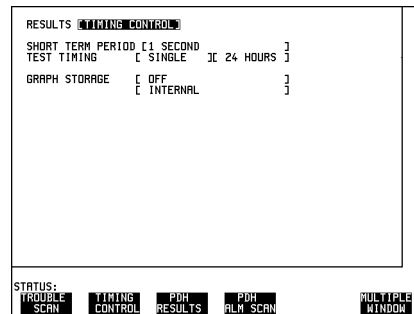

8. View the M.2110 results.

BIS Results of PASS, FAIL and ? (uncertain) are possible.

If PASS is displayed (S1 limit not reached) the path may be returned to service immediately.

If FAIL is displayed (S2 limit reached or exceeded) repeat the BER (G.821) test.

If ? is displayed (result between the S1 and S2 limits) run the 7 day BIS test.

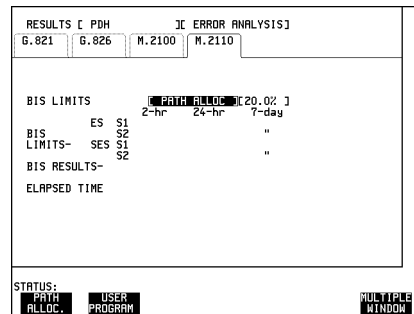

---

# 3

Trouble Scan page 52

Short Term Results page 53

Cumulative Results page 54

PDH Error Analysis G.821, G.826, M.2100, M.2110, M.2120  
page 55

Alarm Seconds page 70

Frequency Measurement page 71

---

## Result Definitions

Information about the PDH results.

Result Definitions  
**Trouble Scan**

---

**Trouble Scan**

All possible error sources and alarms are scanned simultaneously. Up to 4 non-zero error counts are displayed in priority order.

**Error Count Priority**

UPDH (Option UKK[USB])	SDH (Option A3R [A3S])	SPDH (Option UKJ[USA])	SPDH (Option 110)	ATM (Option UKN) + SDH	ATM (Option UKN) + SPDH
CRC BIT CODE FRAME REBE	RS B1 BIP or B1 BIP MS B2 BIP or B2 BIP Path B3 BIP or B3 BIP VC3 PATH BIP TU2 BIP TU12 BIP A1A2 FRAME MS FEBE or MS REI PATH FEBE or HP REI PATH IEC or HP IEC VC3 PATH FEBE or HP REI TU2 FEBE or LP REI TU12 FEBE or LP REI BIT	CRC BIT CODE FAS 140M FAS 34M FAS 8M FAS 2M REBE	CRC4(E2) CRC6(DS1-ESF) BIT CODE FRAME REBE(E1) CP-Parity (DS3 CBP framing) P-Parity (DS3 framing) FEBE (DS3 CBP framing)	B1 BIP (SDH only) B2 BIP (SDH only) B3 BIP (SDH only) Non Corrected HEC Corrected HEC Lost Cells Misinserted Cells Path FEBE or REI Bit Errored Cells	EM BIP Non Corrected HEC Corrected HEC Lost Cells Misinserted Cells EM FEBE Bit Errored Cells

If any alarms are active "ALARMS ACTIVE" is displayed.

**SHOW HISTORY** and the alarm led's can be used to determine which alarms are active.

If no alarms are active and no non-zero error counts are detected then "NO TROUBLE" is displayed.

---

## Short Term Results

Displays period results obtained during the measurement. The period is user-defined under SHORT TERM PERIOD on the **RESULTS** display. Many result parameters are presented in two forms: a count of error events (EC or COUNT) and a ratio of the number of errors to the total possible in the time period (ER or RATIO).

### PDH Results (Options UKJ[USA], UKK[USB] and 110)

<b>BIT EC</b>	Counts Bit errors occurring during the Short Term Period.
<b>BIT ER</b>	Calculates the ratio of Bit errors to the number of clocks in the Short Term Period.
<b>CODE EC</b>	Counts Code errors occurring during the Short Term Period.
<b>CODE ER</b>	Calculates the ratio of Code errors to the number of clocks in the Short Term Period.
<b>FRAME (FAS)</b>	Compares the received FAS word with the correct value.
<b>CRC</b>	Compares the received CRC4 with the calculated CRC4 (2 Mb/s only).
<b>REBE</b>	Detects Bit 1 of the NFAS word in frames 13 and 15 being set to 0 (2 Mb/s only).

If Option 110 (DS1 and DS3 line rates and payloads provided) or option UKJ and A3R is fitted, (DS1 and DS3 payloads) the following additional results are available:

<b>DS1 CRC</b>	Compares the received CRC6 with the calculated CRC6.
<b>DS3 P-Bit</b>	Compares the received P-Bit parity with the calculated parity.
<b>DS3 C-Bit</b>	Compares the received C-Bit parity with the calculated parity.
<b>DS3 FEBE</b>	Calculated from the received FEBE bits.

---

## Cumulative Results

Provides a cumulative display of the results during the measurement period. Many result parameters are presented in two forms: a count of error events (EC or COUNT) and a ratio of the number of errors to the total possible in the time period (ER or RATIO).

### **PDH Results (Options UKJ[USA], UKK [USB] and 110)**

<b>BIT EC</b>	Counts Bit errors occurring during the measurement Period.
<b>BIT ER</b>	Calculates the ratio of Bit errors to the number of clocks in the measurement Period.
<b>CODE EC</b>	Counts Code errors occurring during the measurement Period.
<b>CODE ER</b>	Calculates the ratio of Code errors to the number of clocks in the measurement Period.
<b>FRAME (FAS)</b>	Compares the received FAS word with the correct value.
<b>CRC</b>	Compares the received CRC4 with the calculated CRC4 (2 Mb/s only).
<b>REBE</b>	Detects Bit 1 of the NFAS word in frames 13 and 15 being set to 0 (2 Mb/s only).

If Option 110 (DS1 and DS3 line rates and payloads provided) or option UKJ and A3R is fitted, (DS1 and DS3 payloads) the following additional results are available:

<b>DS1 CRC</b>	Compares the received CRC6 with the calculated CRC6.
<b>DS3 P-Bit</b>	Compares the received P-Bit parity with the calculated parity.
<b>DS3 C-Bit</b>	Compares the received C-Bit parity with the calculated parity
<b>DS3 FEBE</b>	Calculated from the received FEBE bits.

Result Definitions

**PDH Error Analysis G.821, G.826, M.2100, M.2110, M.2120**

---

**PDH Error Analysis G.821, G.826,  
M.2100, M.2110, M.2120**

Analysis results are calculated for the following error sources:

**Option UKK[USB]**

**Out of Service** G.821 BIT (All Rates)

M.2100 (All Rates)

**In-Service** G.821 FRAME (Not 704 kb/s),

G.821 CRC and REBE (2 Mb/s, CRC Framing only).

**Option UKJ[USA], 110**

G.821 BIT and FAS (2,8,34,140 Mb/s), CRC and REBE (2 Mb/s, CRC Framing only).

G.826 (All Rates)

M.2100 (All Rates)

M.2110 BIS Bring Into Service (All Rates)

M.2120 Circuit Maintenance (All Rates)

**G.821 Bit Errors**

These result from a bit by bit comparison of the received pattern and the internal reference pattern.

Table 3-1

**PDH G.821 - Bit Analysis**

Display	Definition
EC	Error Count - Cumulative Bit error count during the measurement period.
ES	Error Second - Cumulative count of seconds within available time that contain at least 1 Bit error. Percentage Error Seconds is also displayed - error seconds expressed as a percentage of the available time.
% Ann. D ES	Percentage Annex D Error Seconds - As% ES, only error second is normalised to 64 kb/s rate as per ITU-T G.821 Annex D.

Result Definitions

**PDH Error Analysis G.821, G.826, M.2100, M.2110, M.2120**

Table 3-1

**PDH G.821 - Bit Analysis**

Display	Definition
EFS	Error Free Seconds - Cumulative count of seconds within available time that contain zero errors. Percentage Error Free Seconds is also displayed - error free seconds expressed as a percentage of the available time.
SES	Severely Errored Seconds - Cumulative count of seconds within available time in which the Bit Error Ratio is $> 1$ in $10^{-3}$ . Percentage Severely Errored Seconds is also displayed - severely errored seconds expressed as a percentage of the available time.
UNAV	Unavailable Seconds - Cumulative count of unavailable seconds. A period of unavailability begins at the start of 10 or more consecutive seconds in which the Bit Error Ratio is $> 1$ in $10^{-3}$ , and ends at the start of 10 or more consecutive seconds in which the Bit Error Ratio is $< 1$ in $10^{-3}$ . Percentage Unavailable Seconds is also displayed - unavailable seconds expressed as a percentage of the total elapsed time.
DEG MIN	Degrade Minutes - Cumulative count of degraded minutes. Available seconds, excluding Severely Errored Seconds, are packaged into 1 minute blocks. The Bit Error Ratio for the packaged block is measured and if it exceeds $1$ in $10^{-6}$ a Degraded Minute is registered. Percentage Degraded Minutes is also displayed -Degraded Minutes expressed as a percentage of the total number of packaged 1 minute blocks.
CODE ES	Code Errored Second - Cumulative count of seconds that contain at least 1 Code error.

**G.821 Frame (FAS) Errors**

These result from a bit by bit comparison of the received FAS word with the correct value, once frame alignment has been achieved.

Table 3-2

**PDH G.821 - Frame (FAS) Analysis (Not 704 kb/s)**

Display	Definition
EC	Error Count - Cumulative Frame error count during the measurement period.
ES	Error Second - Cumulative count of seconds within available time that contain at least 1 Frame error. Percentage Error Seconds is also displayed - error seconds expressed as a percentage of the available time.
% Ann. D ES	Percentage Annex D Error Seconds - As % ES, only error second is normalized to 64 kb/s rate as per ITU-T G.821 Annex D.
EFS	Error Free Seconds - Cumulative count of seconds within available time that contain zero errors. Percentage Error Free Seconds is also displayed - error free seconds expressed as a percentage of the available time.
SES	Severely Errored Seconds - Cumulative count of seconds within available time in which the Bit Error Ratio is $> 1$ in $10^{-3}$ . Percentage Severely Errored Seconds is also displayed - severely errored seconds expressed as a percentage of the available time.

Result Definitions

**PDH Error Analysis G.821, G.826, M.2100, M.2110, M.2120**

Table 3-2

**PDH G.821 - Frame (FAS) Analysis (Not 704 kb/s)**

Display	Definition
UNAV	Unavailable Seconds - Cumulative count of unavailable seconds. A period of unavailability begins at the start of 10 or more consecutive seconds in which the Bit Error Ratio is $> 1$ in $10^{-3}$ , and ends at the start of 10 or more consecutive seconds in which the Bit Error Ratio is $< 1$ in $10^{-3}$ . Percentage Unavailable Seconds is also displayed - unavailable seconds expressed as a percentage of the total elapsed time.
DEG MIN	Degraded Minutes - Cumulative count of degraded minutes. Available seconds, excluding Severely Errored Seconds, are packaged into 1 minute blocks. The Bit Error Ratio for the packaged block is measured and if it exceeds $1$ in $10^{-6}$ a Degraded Minute is registered. Percentage Degraded Minutes is also displayed - degraded minutes expressed as a percentage of the total number of packaged 1 minute blocks.
CODE ES	Code Errored Second - Cumulative count of seconds that contain at least 1 Code error.

**G.821 CRC Errors**

These result from a comparison of the received CRC4 with the calculated CRC4.

Table 3-3

**PDH G.821 - CRC Analysis (2 Mb/s, CRC Framing)**

Display	Definition
EC	Error Count - Cumulative CRC error count during the measurement period.
ES	Error Second - Cumulative count of seconds within available time that contain at least 1 CRC error. Percentage Error Seconds is also displayed - error seconds expressed as a percentage of the available time.
% Ann. D ES	Percentage Annex D Error Seconds - As % ES, only error second is normalized to 64 kb/s rate as per ITU-T G.821 Annex D.
EFS	Error Free Seconds - Cumulative count of seconds within available time that contain zero errors. Percentage Error Free Seconds is also displayed - error free seconds expressed as a percentage of the available time.
SES	Severely Errored Seconds - Cumulative count of seconds within available time in which the Bit Error Ratio is $> 1$ in $10^{-3}$ . Percentage Severely Errored Seconds is also displayed - severely errored seconds expressed as a percentage of the available time.
UNAV	Unavailable Seconds - Cumulative count of unavailable seconds. A period of unavailability begins at the start of 10 or more consecutive seconds in which the Bit Error Ratio is $> 1$ in $10^{-3}$ , and ends at the start of 10 or more consecutive seconds in which the Bit Error Ratio is $< 1$ in $10^{-3}$ . Percentage Unavailable Seconds is also displayed - unavailable seconds expressed as a percentage of the total elapsed time.



Result Definitions

**PDH Error Analysis G.821, G.826, M.2100, M.2110, M.2120**

Table 3-3

**PDH G.821 - CRC Analysis (2 Mb/s, CRC Framing)**

Display	Definition
DEG MIN	Degrade Minutes - Cumulative count of degraded minutes. Available seconds, excluding Severely Errored Seconds, are packaged into 1 minute blocks. The Bit Error Ratio for the packaged block is measured and if it exceeds $1$ in $10^{-6}$ a Degraded Minute is registered. Percentage Degraded Minutes is also displayed - degraded minutes expressed as a percentage of the total number of packaged 1 minute blocks.
CODE ES	Code Errored Second - Cumulative count of seconds that contain at least 1 Code error.

**G.821 REBE Errors**

These are calculated from bit 1 of the NFAS word in frames 13 and 15 of the received 2 Mb/s.

Table 3-4

**PDH G.821 - REBE Analysis (2 Mb/s, CRC Framing)**

Display	Definition
EC	Error Count - Cumulative REBE error count during the measurement period.
ES	Error Second - Cumulative count of seconds within available time that contain at least 1 REBE error. Percentage Error Seconds is also displayed - error seconds expressed as a percentage of the available time.
% Ann. D ES	Percentage Annex D Error Seconds - As % ES, only error second is normalized to 64 kb/s rate as per ITU-T G.821 Annex D.
EFS	Error Free Seconds - Cumulative count of seconds within available time that contain zero errors. Percentage Error Free Seconds is also displayed - error free seconds expressed as a percentage of the available time.
SES	Severely Errored Seconds - Cumulative count of seconds within available time in which the Bit Error Ratio is $> 1$ in $10^{-3}$ . Percentage Severely Errored Seconds is also displayed - severely errored seconds expressed as a percentage of the available time.
UNAV	Unavailable Seconds - Cumulative count of unavailable seconds. A period of unavailability begins at the start of 10 or more consecutive seconds in which the Bit Error Ratio is $> 1$ in $10^{-3}$ , and ends at the start of 10 or more consecutive seconds in which the Bit Error Ratio is $< 1$ in $10^{-3}$ . Percentage Unavailable Seconds is also displayed - unavailable seconds expressed as a percentage of the total elapsed time.
DEG MIN	Degraded Minutes - Cumulative count of degraded minutes. Available seconds excluding Severely Errored Seconds, are packaged into 1 minute blocks. The Bit Error Ratio for the packaged block is measured and if it exceeds $1$ in $10^{-6}$ a Degraded Minute is registered. Percentage Degraded Minutes is also displayed - degraded minutes expressed as a percentage of the total number of packaged 1 minute blocks.
CODE ES	Code Errored Second - Cumulative count of seconds that contain at least 1 Code error.

Result Definitions

**PDH Error Analysis G.821, G.826, M.2100, M.2110, M.2120**

**G.826 PDH Analysis**

PDH G.826 Analysis results are only available on Option UKJ[USA],110.

Table 3-5

**PDH G.826 Analysis - 2 Mb/s CRC4 Framed (PCM30CRC, PCM31CRC)**

Display	Definition
NEAR ES	Receive Error Second - Cumulative count of seconds within available time that contain at least 1 G.703 Code error or 1 CRC error.
FAR ES	Transmit Error Second - Cumulative count of seconds within available time that contain at least 1 REBE error.
NEAR SES	Receive Severely errored Seconds - Cumulative count of 1 second periods within available time that contain at least 805 CRC errors or a DEFECT. Defects are LOS, LOF and AIS.
FAR SES	Transmit Severely errored Seconds - Cumulative count of 1 second periods within available time that contain at least 805 REBE errors or RAI has occurred for 2 consecutive 100 ms periods. Near-end occurrences of LOS, LOF and AIS are not included in the cumulative result.
ESR	Error Second Ratio - The ratio of errored seconds to the total seconds of available time. A period of unavailability begins at the start of 10 or more consecutive Severely Errored Seconds, and ends at the start of 10 or more <b>non</b> Severely Errored Seconds.
SESR	Severely Errored Second Ratio - The ratio of severely errored seconds to the total seconds of available time.
UAS	Unavailable Seconds - Cumulative count of unavailable seconds. A period of unavailability begins at the start of 10 or more consecutive severely errored seconds and ends at the start of 10 or more consecutive <b>non</b> severely errored seconds.
EB	Errored Block count - An errored block is a CRC4 with one or more bits in error.
BBE	Background Block Error count - Cumulative count of errored blocks excluding those in severely errored seconds.
BBER	Background Block Error Ratio - The ratio of errored blocks to total blocks. Total blocks excludes severely errored seconds and periods of unavailability.
PUAS	Path Unavailable Second count - Logical OR of the Near and Far end unavailable seconds.

Table 3-6

**PDH G.826 Analysis - 2 Mb/s Framed - Not CRC4**

Display	Definition
NEAR ES	Receive Error Second - Cumulative count of seconds within available time that contain at least 1 G.703 Code error or 1 Frame error.

Result Definitions

**PDH Error Analysis G.821, G.826, M.2100, M.2110, M.2120**

Table 3-6

**PDH G.826 Analysis - 2 Mb/s Framed - Not CRC4**

Display	Definition
FAR ES	Transmit Error Second - Cumulative count of seconds within available time where RAI occurs for 2 consecutive 100 ms periods.
NEAR SES	Receive Severely errored Seconds - Cumulative count of 1 second periods within available time that contain at least 28 Frame errors or BER $1 \times 10^{-3}$ , or a DEFECT. Defects are LOS, LOF, PSL and AIS.
FAR SES	Transmit Severely errored Seconds - Cumulative count of 1 second periods within available time where RAI occurs for 2 consecutive 100 ms periods. Near-end occurrences of LOS, LOF and AIS are not included in the cumulative result.
ESR	Error Second Ratio - The ratio of errored seconds to the total seconds of available time. A period of unavailability begins at the start of 10 or more consecutive Severely Errored Seconds, and ends at the start of 10 or more <b>non</b> Severely Errored Seconds.
SESR	Severely Errored Second Ratio - The ratio of severely errored seconds to the total seconds of available time.
UAS	Unavailable Seconds - Cumulative count of unavailable seconds. A period of unavailability begins at the start of 10 or more consecutive severely errored seconds and ends at the start of 10 or more consecutive <b>non</b> severely errored seconds.

Table 3-7

**PDH G.826 Analysis - 2 Mb/s Unframed**

Display	Definition
ES	Error Second - Cumulative count of seconds within available time that contain at least 1 G.703 Code error.
SES	Severely errored Seconds - Cumulative count of 1 second periods within available time that contain a DEFECT. Defects are LOS and AIS.
ESR	Error Second Ratio - The ratio of errored seconds to the total seconds of available time. A period of unavailability begins at the start of 10 or more consecutive Severely Errored Seconds, and ends at the start of 10 or more <b>non</b> Severely Errored Seconds.
SESR	Severely Errored Second Ratio - The ratio of severely errored seconds to the total seconds of available time.
UAS	Unavailable Seconds - Cumulative count of unavailable seconds. A period of unavailability begins at the start of 10 or more consecutive severely errored seconds and ends at the start of 10 or more consecutive <b>non</b> severely errored seconds.

Result Definitions

**PDH Error Analysis G.821, G.826, M.2100, M.2110, M.2120**

Table 3-8

**PDH G.826 Analysis - 8 Mb/s Framed**

Display	Definition
NEAR ES	Receive Error Second - Cumulative count of seconds within available time that contain at least 1 Frame error.
FAR ES	Receive Error Second - Cumulative count of seconds within available time where RAI occurs for 2 consecutive 100 ms periods.
NEAR SES	Receive Severely errored Seconds - Cumulative count of 1 second periods within available time that contain at least 41 Frame errors or BER $1 \times 10^{-3}$ or a DEFECT. Defects are LOS, LOF, AIS and PSL.
FAR SES	Transmit Severely errored Seconds - Cumulative count of 1 second periods within available time where RAI occurs for 2 consecutive 100 ms periods. Near-end occurrences of LOS, LOF and AIS are not included in the cumulative result.
ESR	Error Second Ratio - The ratio of errored seconds to the total seconds of available time. A period of unavailability begins at the start of 10 or more consecutive Severely Errored Seconds, and ends at the start of 10 or more <b>non</b> Severely Errored Seconds.
SESR	Severely Errored Second Ratio - The ratio of severely errored seconds to the total seconds of available time.
UAS	Unavailable Seconds - Cumulative count of unavailable seconds. A period of unavailability begins at the start of 10 or more consecutive severely errored seconds and ends at the start of 10 or more consecutive <b>non</b> severely errored seconds.

Table 3-9

**PDH G.826 Analysis - 34 Mb/s Framed**

Display	Definition
NEAR ES	Receive Error Second - Cumulative count of seconds within available time that contain at least 1 Frame error.
FAR ES	Receive Error Second - Cumulative count of seconds within available time where RAI occurs for 2 consecutive 100 ms periods.
NEAR SES	Receive Severely errored Seconds - Cumulative count of 1 second periods within available time that contain at least 52 Frame errors or a DEFECT. Defects are LOS, LOF, AIS and PSL.
FAR SES	Transmit Severely errored Seconds - Cumulative count of 1 second periods within available time where RAI occurs for 2 consecutive 100 ms periods. Near-end occurrences of LOS, LOF and AIS are not included in the cumulative result.
ESR	Error Second Ratio - The ratio of errored seconds to the total seconds of available time. A period of unavailability begins at the start of 10 or more consecutive Severely Errored Seconds, and ends at the start of 10 or more <b>non</b> Severely Errored Seconds.
SESR	Severely Errored Second Ratio - The ratio of severely errored seconds to the total seconds of available time.

Result Definitions

**PDH Error Analysis G.821, G.826, M.2100, M.2110, M.2120**

**Table 3-9**

**PDH G.826 Analysis - 34 Mb/s Framed**

Display	Definition
UAS	Unavailable Seconds - Cumulative count of unavailable seconds. A period of unavailability begins at the start of 10 or more consecutive severely errored seconds and ends at the start of 10 or more consecutive <b>non</b> severely errored seconds.

**Table 3-10**

**PDH G.826 Analysis - 140 Mb/s Framed**

Display	Definition
NEAR ES	Receive Error Second - Cumulative count of seconds within available time that contain at least 1 Frame error.
FAR ES	Receive Error Second - Cumulative count of seconds within available time where RAI occurs for 2 consecutive 100 ms periods.
NEAR SES	Receive Severely errored Seconds - Cumulative count of 1 second periods within available time that contain at least 69 Frame errors or a DEFECT. Defects are LOS, LOF, AIS.
FAR SES	Transmit Severely errored Seconds - Cumulative count of 1 second periods within available time where RAI occurs for 2 consecutive 100 ms periods. Near-end occurrences of LOS, LOF and AIS are not included in the cumulative result.
ESR	Error Second Ratio - The ratio of errored seconds to the total seconds of available time. A period of unavailability begins at the start of 10 or more consecutive Severely Errored Seconds, and ends at the start of 10 or more <b>non</b> Severely Errored Seconds.
SESR	Severely Errored Second Ratio - The ratio of severely errored seconds to the total seconds of available time.
UAS	Unavailable Seconds - Cumulative count of unavailable seconds. A period of unavailability begins at the start of 10 or more consecutive severely errored seconds and ends at the start of 10 or more consecutive <b>non</b> severely errored seconds.

**Table 3-11**

**PDH G.826 Analysis - 8, 34 and 140 Mb/s Unframed**

Display	Definition
ES	Error Second - Cumulative count of seconds within available time that contain at least 1 DEFECT. Defects are LOS and AIS.
SES	Severely errored Seconds - Cumulative count of 1 second periods within available time that contain a DEFECT. Defects are LOS and AIS.
ESR	Error Second Ratio - The ratio of errored seconds to the total seconds of available time. A period of unavailability begins at the start of 10 or more consecutive Severely Errored Seconds, and ends at the start of 10 or more <b>non</b> Severely Errored Seconds.

Result Definitions

**PDH Error Analysis G.821, G.826, M.2100, M.2110, M.2120**

**Table 3-11**

**PDH G.826 Analysis - 8, 34 and 140 Mb/s Unframed**

Display	Definition
SESR	Severely Errored Second Ratio - The ratio of severely errored seconds to the total seconds of available time.
UAS	Unavailable Seconds - Cumulative count of unavailable seconds. A period of unavailability begins at the start of 10 or more consecutive severely errored seconds and ends at the start of 10 or more consecutive <b>non</b> severely errored seconds.

**Table 3-12**

**G.826 Analysis DS1 Unframed**

Display	Definition
ES	Error Second - Cumulative count of seconds within available time that contain at least 1 DEFECT. Defects are LOS, LOF and DS1 AIS.
SES	Severely errored Seconds - Cumulative count of 1 second periods within available time that contain a DEFECT. Defects are LOS, LOF and DS1 AIS.
ESR	Error Second Ratio - The ratio of errored seconds to the total seconds of available time. A period of unavailability begins at the start of 10 or more consecutive Severely Errored Seconds, and ends at the start of 10 or more <b>non</b> Severely Errored Seconds.
SESR	Severely Errored Second Ratio - The ratio of severely errored seconds to the total seconds of available time.
UAS	Unavailable Seconds - Cumulative count of unavailable seconds. A period of unavailability begins at the start of 10 or more consecutive severely errored seconds and ends at the start of 10 or more consecutive <b>non</b> severely errored seconds.

**Table 3-13**

**G.826 Analysis DS3 Unframed**

Display	Definition
ES	Error Second - Cumulative count of seconds within available time that contain at least 1 DEFECT. Defects are LOS, LOF.
SES	Severely errored Seconds - Cumulative count of 1 second periods within available time that contain a DEFECT. Defects are LOS, LOF.
ESR	Error Second Ratio - The ratio of errored seconds to the total seconds of available time. A period of unavailability begins at the start of 10 or more consecutive Severely Errored Seconds, and ends at the start of 10 or more <b>non</b> Severely Errored Seconds.
SESR	Severely Errored Second Ratio - The ratio of severely errored seconds to the total seconds of available time.

Result Definitions

**PDH Error Analysis G.821, G.826, M.2100, M.2110, M.2120**

**Table 3-13**

**G.826 Analysis DS3 Unframed**

Display	Definition
UAS	Unavailable Seconds - Cumulative count of unavailable seconds. A period of unavailability begins at the start of 10 or more consecutive severely errored seconds and ends at the start of 10 or more consecutive <b>non</b> severely errored seconds.

**Table 3-14**

**PDH G.826 Analysis - DS1, D4 & SLC-96 Framing**

Display	Definition
NEAR ES	Receive Error Second - Cumulative count of seconds within available time that contain at least 1 Frame error.
FAR ES	Receive Error Second - Cumulative count of seconds within available time that contain at least 1 DS1 FERF.
NEAR SES	Receive Severely errored Seconds - Cumulative count of 1 second periods within available time that contain at least 8 Frame errors or a DEFECT. Defects are LOS, LOF, DS1 Frame Loss and DS1 AIS.
FAR SES	Transmit Severely errored Seconds - Cumulative count of 1 second periods within available time that contain at least 1 DS1 FERF.
ESR	Error Second Ratio - The ratio of errored seconds to the total seconds of available time. A period of unavailability begins at the start of 10 or more consecutive Severely Errored Seconds, and ends at the start of 10 or more <b>non</b> Severely Errored Seconds.
SESR	Severely Errored Second Ratio - The ratio of severely errored seconds to the total seconds of available time.
UAS	Unavailable Seconds - Cumulative count of unavailable seconds. A period of unavailability begins at the start of 10 or more consecutive severely errored seconds and ends at the start of 10 or more consecutive <b>non</b> severely errored seconds.

**Table 3-15**

**PDH G.826 Analysis - DS1, ESF Framing**

Display	Definition
NEAR ES	Receive Error Second - Cumulative count of seconds within available time that contain at least 1CRC6 error.
FAR ES	Receive Error Second - Cumulative count of seconds within available time that contain at least 1 DS1 FERF.

Result Definitions

**PDH Error Analysis G.821, G.826, M.2100, M.2110, M.2120**

**Table 3-15**

**PDH G.826 Analysis - DS1, ESF Framing**

Display	Definition
NEAR SES	Receive Severely errored Seconds - Cumulative count of 1 second periods within available time that contain at least 320 CRC6 errors or a DEFECT. Defects are LOS, LOF, DS1 Frame Loss and DS1 AIS.
FAR SES	Transmit Severely errored Seconds - Cumulative count of 1 second periods within available time that contain at least 1 DS1 FERF.
ESR	Error Second Ratio - The ratio of errored seconds to the total seconds of available time. A period of unavailability begins at the start of 10 or more consecutive Severely Errored Seconds, and ends at the start of 10 or more <b>non</b> Severely Errored Seconds.
SESR	Severely Errored Second Ratio - The ratio of severely errored seconds to the total seconds of available time.
UAS	Unavailable Seconds - Cumulative count of unavailable seconds. A period of unavailability begins at the start of 10 or more consecutive severely errored seconds and ends at the start of 10 or more consecutive <b>non</b> severely errored seconds.
EB	Errored Block count - An errored block is a CRC6 with one or more bits in error.
BBE	Background Block Error count - Cumulative count of errored blocks excluding those in severely errored seconds.
BBER	Background Block Error Ratio - The ratio of errored blocks to total blocks. Total blocks excludes severely errored seconds and periods of unavailability.
PUAS	Path Unavailable Second count - Logical OR of the Near and Far end unavailable seconds.

**Table 3-16**

**PDH G.826 Analysis - DS3, M13 Framing**

Display	Definition
NEAR ES	Receive Error Second - Cumulative count of seconds within available time that contain at least 1 P-Bit parity error.
FAR ES	Receive Error Second - Cumulative count of seconds within available time that contain at least 1 DS3 FERF.
NEAR SES	Receive Severely errored Seconds - Cumulative count of 1 second periods within available time that contain at least 2444 P-Bit parity or a DEFECT. Defects are LOS, LOF, DS3 Frame Loss and DS3 AIS.
FAR SES	Transmit Severely errored Seconds - Cumulative count of 1 second periods within available time that contain at least 1 DS3 FERF.



Result Definitions

**PDH Error Analysis G.821, G.826, M.2100, M.2110, M.2120**

**Table 3-16**

**PDH G.826 Analysis - DS3, M13 Framing**

Display	Definition
ESR	Error Second Ratio - The ratio of errored seconds to the total seconds of available time. A period of unavailability begins at the start of 10 or more consecutive Severely Errored Seconds, and ends at the start of 10 or more <b>non</b> Severely Errored Seconds.
SESR	Severely Errored Second Ratio - The ratio of severely errored seconds to the total seconds of available time.
UAS	Unavailable Seconds - Cumulative count of unavailable seconds. A period of unavailability begins at the start of 10 or more consecutive severely errored seconds and ends at the start of 10 or more consecutive <b>non</b> severely errored seconds.
EB	Errored Block count - An errored block is a P-Bit parity with one or more bits in error.
BBE	Background Block Error count - Cumulative count of errored blocks excluding those in severely errored seconds.
BBER	Background Block Error Ratio - The ratio of errored blocks to total blocks. Total blocks excludes severely errored seconds and periods of unavailability.
PUAS	Path Unavailable Second count - Logical OR of the Near and Far end unavailable seconds.

**Table 3-17**

**PDH G.826 Analysis - DS3, C-Bit Framing**

Display	Definition
NEAR ES	Receive Error Second - Cumulative count of seconds within available time that contain at least 1 Frame error.
FAR ES	Receive Error Second - Cumulative count of seconds within available time that contain at least 1 DS1 FERF.
NEAR SES	Receive Severely errored Seconds - Cumulative count of 1 second periods within available time that contain at least 8 Frame errors or a DEFECT. Defects are LOS, LOF, DS1 Frame Loss and DS1 AIS.
FAR SES	Transmit Severely errored Seconds - Cumulative count of 1 second periods within available time that contain at least 1 DS1 FERF.
ESR	Error Second Ratio - The ratio of errored seconds to the total seconds of available time. A period of unavailability begins at the start of 10 or more consecutive Severely Errored Seconds, and ends at the start of 10 or more <b>non</b> Severely Errored Seconds.
SESR	Severely Errored Second Ratio - The ratio of severely errored seconds to the total seconds of available time.

## Result Definitions

### PDH Error Analysis G.821, G.826, M.2100, M.2110, M.2120

Table 3-17

#### PDH G.826 Analysis - DS3, C-Bit Framing

Display	Definition
UAS	Unavailable Seconds - Cumulative count of unavailable seconds. A period of unavailability begins at the start of 10 or more consecutive severely errored seconds and ends at the start of 10 or more consecutive <b>non</b> severely errored seconds.
EB	Errored Block count - An errored block is a frame byte with one or more bits in error.
BBE	Background Block Error count - Cumulative count of errored blocks excluding those in severely errored seconds.
BBER	Background Block Error Ratio - The ratio of errored blocks to total blocks. Total blocks excludes severely errored seconds and periods of unavailability.
PUAS	Path Unavailable Second count - Logical OR of the Near and Far end unavailable seconds.

#### PDH M.2100 Analysis

For Option UKK[USB], Analysis results based on ITU-T G.821 or M.2100 can be selected on the **OTHER** **MISCELLANEOUS** display under RESULTS DISPLAY MODE.

For Option UKJ[USA], 110 Analysis results based on ITU-T G.821 or M.2100 can be selected on the **RESULTS** [PDH] [ERROR ANALYSIS] display.

M.2100 Analysis is based on Frame/CRC/REBE errors.

Table 3-18

#### PDH M.2100 - Analysis (Not 704 kb/s)

Display	Definition
RX ES	Receive Error Seconds - Cumulative count of seconds within available time that contain at least 1 FAS error. 2 Mb/s, CRC Framing - Cumulative count of seconds within available time that contain at least 1 CRC4 error.
TX ES	Transmit Error Seconds - 2 Mb/s, CRC Framing only. Cumulative count of seconds within available time that contain at least 1 REBE error.
RX SES	Receive Severely Errored Seconds - Cumulative count of seconds within available time in which the error ratio exceeds a threshold. The threshold changes according to the selected rate as follows: <b>140 Mb/s</b> - $\geq 568$ Frame Bit errors <b>34 Mb/s</b> - $\geq 223$ Frame Bit errors <b>8 Mb/s</b> - $\geq 99$ Frame Bit errors <b>2 Mb/s (Non CRC4)</b> - $\geq 28$ Frame Bit errors <b>2 Mb/s (CRC4)</b> - $\geq 830$ CRC4 errors
TX SES	Transmit Severely Errored Seconds - 2 Mb/s, CRC Framing only. Cumulative count of seconds within available time that contain $\geq 830$ REBE errors.

Result Definitions

**PDH Error Analysis G.821, G.826, M.2100, M.2110, M.2120**

**Table 3-18**

---

**PDH M.2100 - Analysis (Not 704 kb/s)**

Display	Definition
UNAV	Unavailable Seconds - Cumulative count of unavailable second. A period of unavailability begins at the start of 10 or more consecutive Severely Errored Seconds, and ends at the start of 10 or more <b>non</b> Severely Errored Seconds.

Result Definitions

PDH Error Analysis G.821, G.826, M.2100, M.2110, M.2120

**PDH M.2110 BIS (Bring Into Service)**

Provides a 2 Hour, 24 Hour and 7 Day PASS, FAIL, ? indication for BIS testing as described in M.2110. The ES and SES results are compared to the S1 and S2 thresholds and indicate PASS, FAIL or ? (uncertain). If the result is "uncertain", the procedures laid down in M.2110 should be followed.

The S1 and S2 thresholds can be set in two different ways:

- 1. USER PROGRAM - S1 and S2 values are input by the user.
- 2. PATH ALLOCATION - The HP 37717C calculates the S1 and S2 values, from the user entered Path Allocation value, according to tables and procedures in M.2100.

RESULTS [ PDH		] [ ERROR ANALYSIS ]			
G.821	G.826	M.2100	M.2110	M.2120	
BIS LIMITS [USER PROGRAM]					
	ES	S1	2-hr [ 7 ]	24-hr [ 147 ]	7-day [ 1210 ]
	S2	[ 22 ]	[ 199 ]	[ " ]	
LIMITS- SES S1 [ 0 ] [ 0 ] [ " 90 ]					
S2 [ 2 ] [ 8 ]					
BIS RESULTS-					
ELAPSED TIME					
STATUS:					
MULTIPLE WINDOW					

**PDH M.2120 Circuit Maintenance**

Provides a threshold report when any of the relevant thresholds are exceeded within a 15 Minute (TR1 ES & SES) or 24 Hour period (TR2 ES & SES).

The TR1 and TR2 thresholds can be set in two different ways:

- 1. USER PROGRAM - TR1 ES & SES and TR2 ES & SES values are input by the user.
- 2. PATH ALLOCATION - The HP 37717C calculates the TR1 and TR2 values, from the user entered Path Allocation and Maintenance Factor. The Maintenance Factor is a scaling factor used only to calculate the TR2 threshold from the entered Path Allocation.

RESULTS [ PDH		] [ ERROR ANALYSIS ]		
G.821	G.826	M.2100	M.2110	M.2120
MAINT. THRESHOLD [USER PROGRAM]				
	ES	TR1(15-min)	TR2(24-hr)	
MAINTENANCE THRESHOLDS SES [ 120 ] [ 130 ]				
THRESHOLD REPORTS TR [ 15 ] [ 9 ]				
ELAPSED TIME				
STATUS:				
MULTIPLE WINDOW				

Result Definitions

**Alarm Seconds**

---

**Alarm Seconds**

**PDH Alarm Seconds**

Alarm Second measurements are carried out on all the alarms in PDH Status/Alarm Indications except for Clock Loss and FEAC codes (option 120 instruments).

Table 3-19

**PDH Alarm Seconds**

Alarm	Options	Description
Power Loss	UKJ[USA], UKK[USB], 110	All rates
Loss of Signal	UKJ[USA], UKK[USB], 110	All rates
AIS	UKJ[USA], UKK[USB], 110	All rates
Pattern Loss	UKJ[USA], UKK[USB], 110	All rates
LOF 140M	UKJ[USA], 110	140 Mb/s Frame Loss
LOF 34M	UKJ[USA], 110	34 Mb/s Frame Loss
LOF 8M	UKJ[USA], 110	8 Mb/s Frame Loss
LOF 2M	UKJ[USA], 110	2 Mb/s Frame Loss
Frame Loss	UKK[USB]	2 Mb/s In Service Only
DS1 OOF	110	Frame Loss detected
DS3 OOF	110	Frame Loss detected
DS1 AIS	110	Detection of AIS
DS3 AIS	110	Detection of AIS
RAI /X-BIT/YELLOW	UKJ[USA], UKK[USB], 110	Not 704 kb/s
Multiframe Loss	UKJ[USA], UKK[USB], 110	2 Mb/s, CAS or CRC Framing
Remote M'Frame Alarm	UKJ[USA], UKK[USB], 110	2 Mb/s, CAS Framing Only
Excess Zero	110	DS1: applies to B8ZS only.
DS3 Idle	110	Available DS3 only.
DS3 Framing Mismatch	110	Frame format does not match received format

---

## **Frequency Measurement**

Frequency measurement is available at standard PDH and SDH rates.

The measured frequency is displayed in Hz with 1 Hz resolution.

Offset from the standard rate is displayed in Hz and ppm (parts per million). The measurement is carried out continuously, regardless of the state of the RUN/STOP key selection.

Result Definitions  
**Frequency Measurement**

---

## **PDH Logging Messages**



## **Logging Devices**

Results may be logged to the Disc Drive. A color bit map of graphics results can be recorded on the disk drive by using the screen dump feature.

If Remote Control Option A3X is fitted, results may be logged to the Internal Printer.

If Remote Control Option A3B or A3D, is fitted results can be logged to an external HP DeskJet printer or suitable alternative non HP printer.

An alternative suppliers RS-232-C printer can be 40 column width or 80 column width. If a 40 column width printer is used Graphics results cannot be logged.

PDH Logging Messages  
Results Logging

---

## Results Logging

Header and results are logged to the selected device when:

- **PRINT NOW** is pressed.
- If LOGGING [ON] is selected on the **OTHER LOGGING** display and a measurement is started by pressing **RUN/STOP**

```
=====
                          Hewlett Packard HP37717C
                          Instrument Configuration
-----
RECEIVER
  Receive Signal   : 34 Mb/s           Termination      : 75 Ohm UNBAL
  Linecode         : HDB3              Payload          : FRAMED
  Payload Type    : UNFRAMED
  Pattern         : 2^23-1             Polarity         : INVERTED
  Hit Threshold   : 1.00               Filter           : OFF
  Range           : 1.6 UI             RMS Filter       : 12 kHz HP
MEASUREMENT STARTED 23 Jul 97 13:09:02      Print Period 10 Minutes
-----
```

### Logging Header Example

## PDH Logging Messages

### Results Logging

If **PRINT NOW** is pressed the cumulative results are logged. If a measurement is in progress the current results are logged. If a measurement is not in progress the cumulative results for the last measurement are logged.

### During the Measurement Period

If LOG ERROR SECOND [ON] is selected on the **OTHER** LOGGING display all occurrences of an Error Second will be logged:

- Bit
- Code (PDH)
- Frame (PDH)
- CRC (PDH)
- REBE (PDH)
- DS3 Frame (SDH)
- DS3 P-Bit (SDH)
- DS3 C-Bit (SDH)
- DS3 FEBE (SDH)
- DS1 Frame (SDH)
- DS1 CRC6 (SDH)
- A1A2 FRAME (SDH)
- RS B1 BIP/B1 BIP (SDH)
- MS B2 BIP/B2 BIP (SDH)
- MS FEBE/RS REI (SDH)
- Path B3 BIP/B3 BIP (SDH)
- Path FEBE/HP REI (SDH)
- Path IEC/HP IEC (SDH)
- TU Path BIP (SDH)
- TU Path FEBE/LP REI (SDH)
- Hit Count (Jitter)
- Hit seconds (Jitter)
- Positive Peak Amplitude (Jitter)

## PDH Logging Messages

### Results Logging

- Negative Peak Amplitude (Jitter)
- Peak to Peak Amplitude (Jitter)
- RMS Amplitude (Jitter)
- Positive Peak (2Mb/s Wander)
- Negative Peak (2Mb/s Wander)
- Peak to Peak (2Mb/s Wander)
- Peak to Peak (15 min) (2Mb/s Wander)
- Peak to Peak (24 hours) (2Mb/s Wander)
- Time Interval Error (2Mb/s Wander)
- Estimated Bit Slips (2Mb/s Wander)
- Estimated Frame Slips (2Mb/s Wander)
- EM BIP (ATM)
- FEBE/REI (ATM)
- Corrected HEC (ATM)
- Non Corrected HEC (ATM)
- Cell Loss (ATM)
- Errored Cells (ATM)
- Misinserted Cells (ATM)

All Alarm occurrences will be logged both when set and cleared:

- Signal Loss
- AIS (PDH & ATM)
- Pattern Sync Loss (PDH & ATM)
- Loss Of Frame (SDH, PDH & ATM)
- Out Of Frame (SDH)
- Multiframe (PDH)
- Remote Loss (PDH)
- Remote Multiframe Loss (PDH)
- Loss of Pointer (SDH)

## PDH Logging Messages

### Results Logging

- MS AIS (SDH)
- Path AIS/AU AIS (SDH)
- Pattern Loss (SDH)
- Clock Loss (SDH)
- MS FERF/MS RDI (SDH)
- Path FERF/HP RDI (SDH)
- K1K2 Change (SDH)
- H4 Multiframe Loss (SDH)
- TU Loss of Pointer (SDH)
- TU AIS (SDH)
- TU Path FERF/LP RDI (SDH)
- DS3 Frame Loss (SDH)
- DS3 AIS (SDH)
- DS3 FERF (SDH)
- DS1 Frame Loss (SDH)
- DS1 AIS (SDH)
- DS1 FERF (SDH)
- Jitter Lock Loss (Option UHN[US9])
- Excess Jitter (Option UHN[US9])
- Excess Wander (Option UHN[US9])
- Wander Ref Loss (Option UHN[US9])
- Wander Signal Loss (Option UHN[US9])
- FERF/RDI (ATM)
- Loss of Cell Sync (ATM)
- Selected Cell Not Received (ATM)
- Congestion Experienced (ATM)
- Test Cell Loss (ATM)
- VP AIS (ATM)

## PDH Logging Messages

### Results Logging

- VP FERF/VP RDI (ATM)
- VC AIS (ATM)
- VC FERF/VC RDI (ATM)

In addition the following events are logged:

- All Alarms Clear
- Power Failure
- Power Restored
- New Day
- Squelched - Printing stopped to conserve paper during period of Unavailability
- Unsquelched - Printing restarted after period of Unavailability
- Print Demanded - if **PRINT NOW** is pressed.
- Print Period - if selected on **OTHER LOGGING** display.
- Printing Enabled - if Printer enabled during a measurement.
- Measurement Complete

```
| 13:02:48                ALL ALARMS CLEAR
| 13:03:04  AIS 140M      SET
| 13:03:04  Jitter Unlock SET
| 13:03:04  Signal Loss 140M SET
| 13:03:04  Pattern Loss  SET
| 13:03:04  AIS 140M      CLEAR
| 13:03:04  Jitter Unlock  CLEAR
| 13:03:08  Signal Loss 140M CLEAR
| 13:03:08  AIS 140M      SET
| 13:03:08  Jitter Unlock  SET
| 13:03:08  AIS 140M      CLEAR
| 13:03:08  Pattern Loss  CLEAR
| 13:03:17  Jitter Unlock  CLEAR
| 13:03:18                ALL ALARMS CLEAR
| 13:03:41  AIS 140M      SET
| 13:03:42  Pattern Loss  SET
| 13:03:49  Pattern Loss  CLEAR
| 13:03:49  AIS 140M      CLEAR
| 13:03:50                ALL ALARMS CLEAR
```

### Logging During Measurement Example

PDH Logging Messages  
**Results Logging**

**At the End of the Measurement Period**

A complete set of measurement results are logged.

```

=====
MEASUREMENT COMPLETE 23 Jul 97 13:45:17 Elapsed Time 00d 00h 02m 27s
=====
Cumulative Results

Error Results :
Error Count          FAS 140M   FAS 34M   FAS 8M   FAS 2M
Error Ratio          N/A       0         N/A     N/A
                    N/A       0         N/A     N/A

Error Count          BIT (test)  CODE     CRC     REBE
Error Ratio          0         0        N/A    N/A

Hit Count
Hit Seconds          147285
Hit Free Seconds     56
Positive Peak        0.736
Negative Peak        0.746
Peak-to-Peak        1.482
RMS                  0.040

Analysis Results :
G.821 ANALYSIS
Error Count          BIT (test)  FAS 140M  FAS 34M  FAS 8M  FAS 2M
%Errored Sec        0           N/A       0         N/A     N/A
%Errored Sec        0.00000    N/A       0.00000  N/A     N/A
%ES (Annex D)       0.00000    N/A       N/A      N/A     N/A
Error Free Sec      147         N/A       147      N/A     N/A
%Error Free Sec     100         N/A       100     N/A     N/A
Severely Err Sec    0           N/A       0         N/A     N/A
%Severely Err Sec  0.00000    N/A       0.00000  N/A     N/A
Degraded Minutes    0           N/A       0         N/A     N/A
%Degraded Minutes  0.00000    N/A       0.00000  N/A     N/A
Unavailable Sec      0           N/A       0         N/A     N/A
%Unavailable Sec    0.00000    N/A       0.00000  N/A     N/A

Error Count          CODE     CRC4     REBE
%Errored Sec        0         N/A     N/A
%Errored Sec        N/A      N/A     N/A
Error Free Sec      N/A      N/A     N/A
%Error Free Sec     N/A      N/A     N/A
Severely Err Sec    N/A      N/A     N/A
%Severely Err Sec  N/A      N/A     N/A
Degraded Minutes    N/A      N/A     N/A
%Degraded Minutes  N/A      N/A     N/A
Unavailable Sec      N/A      N/A     N/A
%Unavailable Sec    N/A      N/A     N/A

G.826 ANALYSIS
Near 140Mb/s Far    Near 34Mb/s Far
Errored Seconds      N/A      N/A      0      0
Severely Errored Seconds N/A      N/A      0      0
Unavailable Seconds  N/A      N/A      0      0
Path Unavailable Seconds N/A      N/A      0      0
Errored Second Ratio N/A      N/A      0      0
Severely Errored Sec Ratio N/A      N/A      0      0

```

## PDH Logging Messages Results Logging

	M.2100 ANALYSIS			
	Rx 140Mb/s	Tx	Rx 34Mb/s	Tx
Errored Seconds	N/A	N/A	0	0
Severely Errored Seconds	N/A	N/A	0	0
Unavailable Seconds	N/A	N/A	0	0
	M.2110 ANALYSIS			
BIS Results		2-hr WAIT	24-hr WAIT	7-day WAIT
	M.2120 ANALYSIS			
	TR1 Rx	TR1 Tx	TR2 Rx	TR2 Tx
Threshold Reports	0	0	0	0
Frequency :	34368011 Hz	Offset :	11 Hz	Offset :
				+0.3 ppm

### Logging At End of Measurement Example

## Bar Graph Logging

To log the Bar Graphs:

On the **OTHER LOGGING** display, LOGGING SETUP **DEVICE**, select the required logging device under LOGGING PORT .

On the **OTHER LOGGING CONTROL** display, select LOGGING [ON] .

Display the Bar Graphs required on the Bar Graph display and press **PRINT** .

Select **THIS SCREEN**

The Error Summary, the Alarm Summary, the selected Bar Graphs and the Alarms Graph are logged.



## PDH Logging Messages Results Logging

Hewlett Packard HP37717 C Graphical Text Results					
MEASUREMENT STARTED : 09:25 26-NOV-1993					
TEST DURATION : 00d 01h 00m					
Error Summary					
	Count	Ratio	CODE	Count	Ratio
BIT	1.486E+06	2.885E-06		1.559E+08	3.189E-04
Alarm Summary					
Power Loss		0			
LDS		1			
AIS		5			
PSL		5			

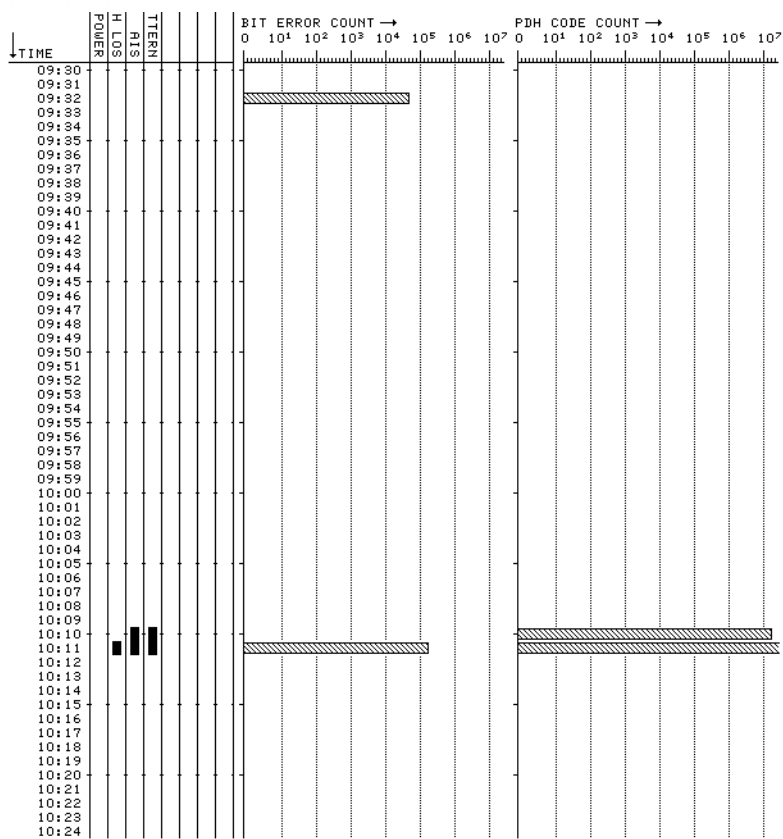

## Bar Graph Logging

PDH Logging Messages  
**Results Logging**

**Graphics Text Results Logging**

To log the Alarm Summaries:

Select the required logging device under LOGGING PORT on the **OTHER LOGGING** display.

Select LOGGING [ON] on the **OTHER LOGGING** display (RS232 or HPIB).

Display the results required on the Text Results display and press **PRINT**.  
 The Error Summary and Alarm Summary are logged.

**Results Snapshot Logging**

To log the Results Snapshot:

Select the required External logging device under LOGGING PORT on the **OTHER LOGGING** display.

Select LOGGING [ON] on the **OTHER LOGGING** display.

Select LOG ON DEMAND [RESULTS] on the **OTHER LOGGING** display and press **PRINT NOW**.

```

=====
                                Hewlett Packard HP37717C
                                Instrument Configuration
=====
RECEIVER
  Receive Signal   : 34 Mb/s           Termination      : 75 Ohm UNBAL
  Linecode        : HDB3              Payload          : FRAMED
  Payload Type    : UNFRAMED
  Pattern         : 2^23-1            Polarity         : INVERTED
  Hit Threshold   : 1.00              Filter           : OFF
  Range          : 1.6 UI             RMS Filter       : 12 kHz HP
=====
MEASUREMENT STARTED  23 Jul 97  13:09:02      Print Period  10 Minutes
=====
13:10:07 PRINT DEMANDED- RESULTS SNAPSHOT      Elapsed Time  00d 00h 01m 04s
=====
                                Cumulative Results
=====
Error Results :
Error Count    FAS 140M  FAS 34M  FAS 8M  FAS 2M
Error Ratio    N/A      0        N/A    N/A
Error Ratio    N/A      0        N/A    N/A

Error Count    BIT (test)  CODE    CRC    REBE
Error Count    946675    0       N/A   N/A
Error Ratio    4.275E-04  0       N/A   N/A

Hit Count      JITTER
Hit Seconds    0
Hit Seconds    0
=====
    
```

## PDH Logging Messages Results Logging

```

Hit Free Seconds                                     64
Positive Peak                                       0.016
Negative Peak                                       0.036
Peak-to-Peak                                       0.052
RMS                                                 0.001

Analysis Results :

G.821 ANALYSIS
      BIT (test)   FAS 140M   FAS 34M   FAS 8M   FAS 2M
Errored Sec           61         N/A       14      N/A      N/A
%Errored Sec        95.31250      N/A     21.87500  N/A      N/A
%ES (Annex D)       72.25388      N/A       N/A     N/A      N/A
Error Free Sec         3         N/A       50      N/A      N/A
%Error Free Sec     4.68750      N/A     78.12500  N/A      N/A
Severely Err Sec     14         N/A       14      N/A      N/A
%Severely Err Sec  21.87500      N/A     21.87500  N/A      N/A
Degraded Minutes     N/A         N/A       N/A     N/A      N/A
%Degraded Minutes   N/A         N/A       N/A     N/A      N/A
Unavailable Sec       0         N/A       0       N/A      N/A
%Unavailable Sec    0.00000      N/A     0.00000  N/A      N/A

      CODE      CRC4      REBE
Errored Sec           0         N/A     N/A
%Errored Sec         N/A       N/A     N/A
Error Free Sec       N/A       N/A     N/A
%Error Free Sec     N/A       N/A     N/A
Severely Err Sec    N/A       N/A     N/A
%Severely Err Sec  N/A       N/A     N/A
Degraded Minutes   N/A       N/A     N/A
%Degraded Minutes  N/A       N/A     N/A
Unavailable Sec    N/A       N/A     N/A
%Unavailable Sec   N/A       N/A     N/A

G.826 ANALYSIS
      Near 140Mb/s Far      Near 34Mb/s Far
Errored Seconds           N/A       N/A       14       9
Severely Errored Seconds N/A       N/A       14       9
Unavailable Seconds       N/A       N/A       0        0
Path Unavailable Seconds  N/A       N/A       0        0
Errored Second Ratio      N/A       N/A     2.188E-01  1.800E-01
Severely Errored Sec Ratio N/A       N/A     2.188E-01  1.800E-01

M.2100 ANALYSIS
      Rx 140Mb/s Tx      Rx 34Mb/s Tx
Errored Seconds           N/A       N/A       17       9
Severely Errored Seconds N/A       N/A       6        9
Unavailable Seconds       N/A       N/A       44       0

M.2110 ANALYSIS
      2-hr      24-hr      7-day
BIS Results      WAIT      WAIT      WAIT

M.2120 ANALYSIS
      TR1 Rx      TR1 Tx      TR2 Rx      TR2 Tx
Threshold Reports      0        0        1        1

Frequency : 34367996 Hz      Offset :      -4 Hz      Offset :      -0.1 ppm
=====

```

### Results Snapshot Logging Example

---

# Index

---

- A**
  - Alarm Monitoring, 10
  - Alarm scan display, 12
  - Alarm Seconds
    - PDH, 70
  - Alarm seconds display, 12
  - Analysis of N X 64 kb/s, 13
- B**
  - Bar Graph Logging, 81
  - BERT Testing, 17
  - Binary Interfaces, Option UH3 (US7)
    - Module Information, 5
- C**
  - Coupled Settings, 48
  - Cross Multiplexer Testing, 22
- D**
  - Default Settings, 48
  - DS1, DS3, E1 and E3 Interfaces for ATM
    - Payloads, Option UKZ
    - Module Information, 7
- E**
  - End to End BERT Testing, 17
- F**
  - FAS Monitoring, 28
  - Frequency Measurement, 32, 71
  - Frequency Offset Tolerance, 35
- G**
  - G.821 Analysis
    - Bit, 55
    - CRC, 57
    - Frame (FAS), 56
    - REBE, 58
  - G.826 Analysis
    - 140 Mb/s Framed, 62
    - 2 Mb/s CRC4 Framed, 59
    - 2 Mb/s Framed Not CRC4, 59
    - 2 Mb/s Unframed, 60
    - 34 Mb/s Framed, 61
    - 8 Mb/s Framed, 61
    - 8, 34 and 140 Mb/s Unframed, 62
    - DS1 Unframed, 63
    - DS1, D4 & SLC-96 Framing, 64
    - DS1, ESF Framing, 64
    - DS3 Unframed, 63
    - DS3, C-Bit Framing, 66
    - DS3, M23 Framing, 65
  - Graph
    - Storage resolution selection, 21
  - Graphics
    - Bar Graph Logging, 82
    - Logging Bar Graphs, 81
- I**
  - Introduction to PDH, 2
- L**
  - Logging At End of Measurement, 81
  - Logging Bar Graphs, 82
  - Logging Devices, 74
  - Logging During Measurement, 79
  - Logging Header, 75
  - Logging Results
    - At end of Measurement, 80
    - Bar Graphs, 80
    - During Measurement, 76
    - Error & Alarm Summaries, 83
    - Graphics Text, 83
    - Logging Header, 75
    - Result Snapshot, 83
  - Loopback BERT Testing, 18
- M**
  - M.2100 Frame Analysis, 67
  - M.2110 BIS Analysis, 69
  - M.2120 Circuit Maintenance, 69
  - M2100, M2110, M2120 Analysis, 47
  - Multiple PDH Outputs, Option UHC
    - Module Information, 6
  - Multiplexer Testing, 39
- P**
  - PDH Alarm Seconds, 70
  - PDH Results
    - Cumulative, 54
    - Error Analysis, 55–69
    - Short Term, 53
- R**
  - Receive and transmit settings linked, 14
  - Results Definitions
    - Cumulative PDH, 54
    - Frequency Measurement, 71
    - G.821 Bit Analysis, 55
    - G.821 CRC Analysis, 57
    - G.821 Frame Analysis, 56
    - G.821 REBE Analysis, 58
    - G.826 PDH Analysis, 59
    - M.2100 Analysis, 67
    - M.2110 Analysis, 69
    - M.2120 Analysis, 69
    - PDH Alarm Seconds, 70
    - Short Term PDH, 53
    - Trouble Scan, 52
  - Results Snapshot Logging Example, 84
  - Round Trip Delay, 44
- S**
  - Settings Coupled, 48
  - Short Term Results
    - PDH, 53
  - Storage resolution selection, 21
  - Structured PDH Multiplexer Test, 40
- T**
  - Timeslot selection, 14
  - Transmit and receive settings linked, 14
  - Trouble Scan, 52
- U**
  - Unstructured PDH Multiplexer Test, 40
  - Unstructured PDH, Option UKK
    - Module Information, 3

---

## **Index**

---

## Hewlett-Packard Sales and Service Offices

If you need technical assistance with a Hewlett-Packard test and measurement product or application please contact the Hewlett-Packard office or distributor in your country.

### **Asia Pacific:**

#### ***Hong Kong:***

Tel: (852) 2599 7889

#### ***India:***

Tel: (91-11) 682-6000

#### ***Japan:***

Hewlett-Packard Japan Ltd.  
Measurement Assistance Center  
9-1, Takakura-Cho, Hachioji-Shi,  
Tokyo 192-8510, Japan  
Tel: (81) 426-56-7832  
Fax: (81) 426-56-7840

#### ***Korea:***

Tel: (82-2) 769 0800

#### ***Malaysia:***

Tel: (60-3) 291 0213

#### ***Philippines:***

Tel: (63-2) 894 1451

#### ***People's Republic of China:***

Tel: (86-10) 6505 0149

#### ***Singapore:***

Tel: (1800) 292 8100

#### ***Taiwan:***

Tel: (886-3) 492 9666

#### ***Thailand:***

Tel: (66-2) 661 3900

### ***For countries in Asia Pacific not listed, contact:***

Hewlett-Packard Asia Pacific Ltd  
17-21/F Shell Tower, Times Square,  
1 Matheson Street  
Causeway Bay  
Hong Kong  
Tel: (852) 2599 7777  
Fax: (852) 2506 9285

### **Australia/New Zealand:**

Hewlett-Packard Australia Ltd.  
31-41 Joseph Street  
Blackburn, Victoria 3130  
Australia  
Tel: 1 800 629 485

### **Canada:**

Hewlett-Packard Canada Ltd.  
5150 Spectrum Way  
Mississauga, Ontario  
L4W 5G1  
Tel: (905) 206 4725

### **Europe, Africa and Middle East:**

#### ***Austria:***

Tel: (0)1 25000-0

#### ***Belgium and Luxembourg:***

Tel: (02) 778 3417

#### ***Baltic Countries:***

Tel: (358) 08872 2100

#### ***Czech Republic:***

Tel: 420-2-4743111

#### ***Denmark:***

Tel: 45 99 10 00

## **Hewlett-Packard Sales and Service Offices (cont'd)**

***Finland:***

Tel: (90) 88 721

***France:***

Tel: (0)1 69.82.60.60

***Germany:***

Tel: (0180) 532 62-33

***Greece:***

Tel: 30-1-7264045

***Hungary:***

Tel: 36-1-4618219

***Ireland:***

Tel: (01) 284 4633

***Israel:***

Tel: 972-3-5380333

***Italy:***

Tel: 02 - 92 122 241

***Netherlands:***

Tel: (020) 547 6669

***Norway:***

Tel: (22) 73 57 50

***Poland:***

Tel: 48-22-6087700

***Portugal:***

Tel: (11) 482 85 00

***Russia:***

Tel: (7/095) 928 6885

Fax: (7/095) 916 9844

***South Africa:***

Tel: 27-22-8061000

***Spain:***

Tel: (34) 1 631 1323

***Sweden:***

Tel: (08) 444 22 77

***Switzerland:***

Tel: (01) 735 7111

***Turkey:***

Tel: 90-212-2245925

***United Kingdom:***

Tel: (01344) 366 666

***For countries in Europe/Middle East  
and Africa not listed, contact:***

Hewlett-Packard  
International Sales Europe  
Geneva, Switzerland  
Tel: +41-22-780-4111  
Fax: +41-22-780-4770

***Latin America:***

Hewlett-Packard  
Latin American Region Headquarters  
5200 Blue Lagoon Drive  
9th Floor  
Miami, Florida 33126  
U.S.A.  
Tel: (305) 267-4245  
Tel: (305) 267-4220  
Fax: (305) 267-4288

***United States:***

Hewlett-Packard Company  
Test and Measurement Organization  
5301 Stevens Creek Blvd.  
Bldg. 51L-SC  
Santa Clara, CA 95052-8059  
Tel: 1 800 452 4844

---

### **About This Edition**

This is the 1st edition of the 37717-90407 manual. It documents the product as of March 1998. Edition dates are as follows:

1st Edition, March 1998

© Copyright Hewlett-Packard Ltd. 1998.

All rights reserved. Reproduction, adaption, or translation without prior written permission is prohibited, except as allowed under the copyright laws.



## **In This Book**

This book provides information on HP 37717C modules with PDH capability. It also provides applications associated with these modules.

The individual applications contain techniques which may be of value for purposes other than those shown.

Printed in U.K. 03/98  
37717-90407





## Artisan Technology Group is your source for quality new and certified-used/pre-owned equipment

- FAST SHIPPING AND DELIVERY
- TENS OF THOUSANDS OF IN-STOCK ITEMS
- EQUIPMENT DEMOS
- HUNDREDS OF MANUFACTURERS SUPPORTED
- LEASING/MONTHLY RENTALS
- ITAR CERTIFIED SECURE ASSET SOLUTIONS

### SERVICE CENTER REPAIRS

Experienced engineers and technicians on staff at our full-service, in-house repair center

### *InstraView*<sup>SM</sup> REMOTE INSPECTION

Remotely inspect equipment before purchasing with our interactive website at [www.instraview.com](http://www.instraview.com) ↗

### WE BUY USED EQUIPMENT

Sell your excess, underutilized, and idle used equipment. We also offer credit for buy-backs and trade-ins. [www.artisanng.com/WeBuyEquipment](http://www.artisanng.com/WeBuyEquipment) ↗

### LOOKING FOR MORE INFORMATION?

Visit us on the web at [www.artisanng.com](http://www.artisanng.com) ↗ for more information on price quotations, drivers, technical specifications, manuals, and documentation

**Contact us:** (888) 88-SOURCE | [sales@artisanng.com](mailto:sales@artisanng.com) | [www.artisanng.com](http://www.artisanng.com)