



Artisan Technology Group is your source for quality new and certified-used/pre-owned equipment

- FAST SHIPPING AND DELIVERY
- TENS OF THOUSANDS OF IN-STOCK ITEMS
- EQUIPMENT DEMOS
- HUNDREDS OF MANUFACTURERS SUPPORTED
- LEASING/MONTHLY RENTALS
- ITAR CERTIFIED SECURE ASSET SOLUTIONS

SERVICE CENTER REPAIRS

Experienced engineers and technicians on staff at our full-service, in-house repair center

*InstraView*SM REMOTE INSPECTION

Remotely inspect equipment before purchasing with our interactive website at www.instraview.com ↗

WE BUY USED EQUIPMENT

Sell your excess, underutilized, and idle used equipment. We also offer credit for buy-backs and trade-ins. www.artisanng.com/WeBuyEquipment ↗

LOOKING FOR MORE INFORMATION?

Visit us on the web at www.artisanng.com ↗ for more information on price quotations, drivers, technical specifications, manuals, and documentation

Contact us: (888) 88-SOURCE | sales@artisanng.com | www.artisanng.com

**Quick Start
Guide**

**HP 37717C
Communications
Performance Analyzer**

© Copyright Hewlett-Packard Ltd. 1998

All rights reserved. Reproduction, adaptation, or translation without prior written permission is prohibited, except as allowed under the copyright laws.

HP Part No.
37717-90401

First edition, 03/98

Printed in U.K.

Documentation Warranty

The information contained in this document is subject to change without notice.

Hewlett-Packard makes no warranty of any kind with regard to this material, including, but not limited to, the implied warranties or merchantability and fitness for a particular purpose.

Hewlett-Packard shall not be liable for errors contained herein or for incidental or consequential damages in connection with the furnishing, performance, or use of this material.

WARNING

For details of safety, see Safety information at the front of the Calibration manual.

Warning Symbols Used on the Product



The product is marked with this symbol when the user should refer to the instruction manual in order to protect the apparatus against damage.

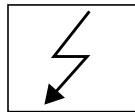

The product is marked with this symbol to indicate that hazardous voltages are present



EN 60825 1991

The product is marked with this symbol to indicate that a laser is fitted. The user should refer to the laser safety information in the Calibration Manual.

Hewlett-Packard Limited
Telecommunications Networks Test Division
South Queensferry
West Lothian, Scotland EH30 9TG

Quick Start Guide

HP 37717C Communications Performance Analyzer

About This Book

The Quick Start Guide demonstrates the basic operation of the instrument.

This guide tells you how to select the displays that you want and how to use them to modify the instrument functions.

This guide also tells you about the front panel key functions, the indicators and the connectors.





Contents

Introduction to the 37717C Front Panel	7
Selecting Displays	8
Selecting Multiple or Single Windows	9
Moving Around Multiple Windows	10
Selecting the Graph or Other Display in Multiple Windows	11
Changing the Displayed Folder	13
Changing the Instrument Settings	14
Modifying Displays with Pop-up Menus	16
Making Selections using Pictorial and Graphic Displays.	20
Using with a Monitor	24
Using the Other Front Panel Keys	25
Monitoring Status	27
Displaying Status History	27
General Alarm Indicators	28
PDH / DS _n Alarm Indicators	28
ATM Alarm Indicators	28
Jitter Alarm Indicators	28
SDH Alarm Indicators	29
SONET Alarm Indicators (Option 120)	29

Contents

Getting Started

Getting Started shows you how to select displays and use them to change the instrument settings. Getting started includes the following:

- How to select single or multiple windows
- How to obtain the required display using the display select keys, **TRANSMIT** ; **RECEIVE** ; **RESULTS** ; **GRAPH** ; **OTHER**
- How to modify the display information, using    and  and the display softkeys or pop-up menus
- How to use the other front panel keys
- How to interpret the front panel status indicators
- How to connect to external equipment

Introduction to the 37717C Front Panel

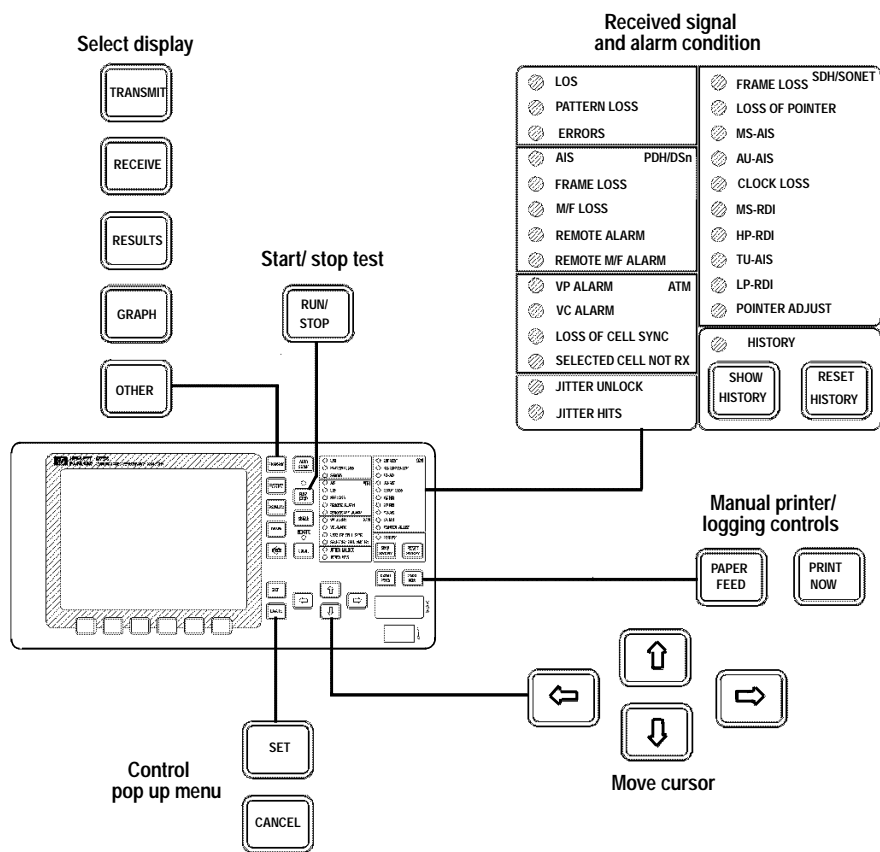

The operator interface is provided by the display and the front panel keys.

The display may be multiple windows or a single window.

When the display is multiple windows, the "active" window is indicated with a color which is different from the color of the three "inactive" windows.

Getting Started
Selecting Displays

Selecting Displays

A multiple window display is available. The displayed pages are: Transmitter Output, Receiver Input, Results and either Graph or Other (Function).



TRANSMIT

Allows control of the settings associated with the generated signal.

RECEIVE

Allows control of the settings associated with the received signal.

RESULTS

Allows control of the test timing and graph storage and displays the selected measurement results.

GRAPH

Allows management of the stored graphical results.

OTHER

Allows control of Stored Settings, Settings Control, Floppy Disk, Logging, Remote Control, Time & Date, Miscellaneous (Keyboard Lock, Beep on Received Error, Suspend Test on Signal Loss), Option and Option Enable, Calibration, Autsetup and Color Control.

A list of Options fitted is also displayed.

Getting Started
 Selecting Displays

Selecting Multiple or Single Windows

To select single window, use the display keys **TRANSMIT**; **RECEIVE**; **RESULTS**; **GRAPH** and **OTHER** , to select the display required and then press **SINGLE WINDOW**.

Most examples in this manual use SINGLE window. To return to multiple windows, press **MULTIPLE WINDOW**.

Example: To obtain a single window transmit display, Use **TRANSMIT** to make the transmit window active.

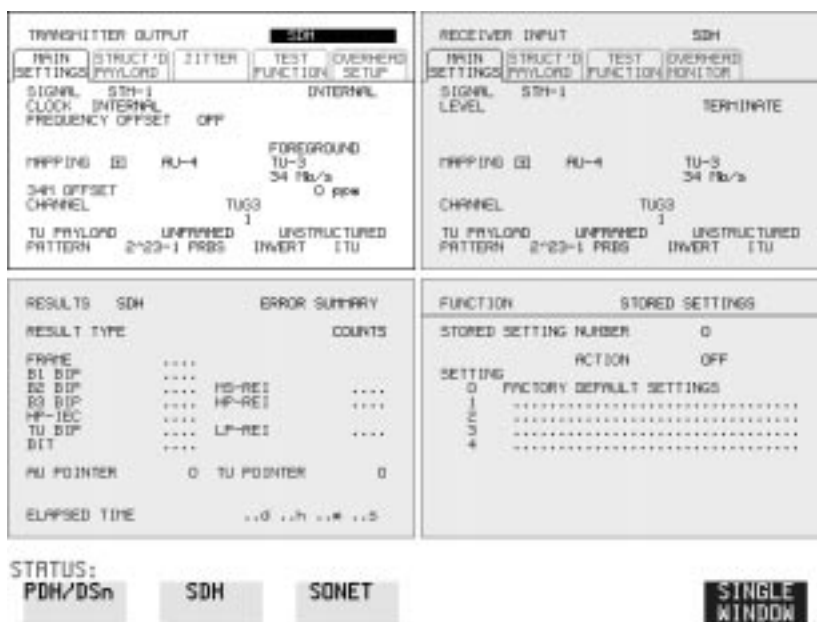

Getting Started Selecting Displays

Use **SINGLE WINDOW** to obtain a single transmit window display

To change the page displayed in the single window, press the page key for the page required (e.g. RECEIVE, RESULTS, GRAPH or OTHER) .

When returning to multiple windows, the current single window display will become the active display within the multiple windows.



Moving Around Multiple Windows

To move the cursor to another of the displayed windows, press the display selection key for that window.

Example: The cursor is in the TRANSMITTER OUTPUT window at the top left of the display.

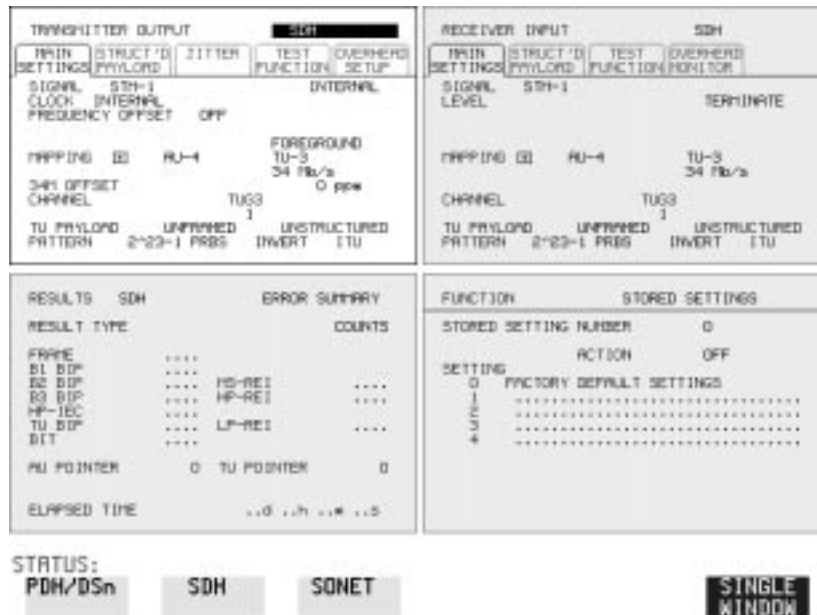

Getting Started Selecting Displays

If you want to make changes to the receive display, you need to make the receive display "active". To move the cursor to the RECEIVER INPUT window at the top right of the display, press **RECEIVE**.



Selecting the Graph or Other Display in Multiple Windows

Press **OTHER** or **GRAPH** for the display that you want.

Example: To change the display from **OTHER** to **GRAPH**. Press **GRAPH**.

Getting Started Selecting Displays

Display with **OTHER** FUNCTION

The screenshot displays the main menu of the instrument, divided into four quadrants:

- Top Left: TRANSMITTER OUTPUT SBH**
 - SIGNAL: STM-1
 - CLOCK: INTERNAL
 - FREQUENCY OFFSET: OFF
 - MAPPING: AU-4
 - FORGROUND: Tu-3, 34 Mb/s
 - 341 OFFSET: 0 ppm
 - CHANNEL: TUG3, 1
 - TU PHYLOG: PARED
 - PATTERN: 2-23-1 PRBS
- Top Right: RECEIVER INPUT SBH**
 - SIGNAL: STM-1
 - LEVEL: TERMINATE
 - MAPPING: AU-4
 - TU-3, 34 Mb/s
 - CHANNEL: TUG3, 1
 - TU PHYLOG: PARED
 - PATTERN: 2-23-1 PRBS
- Bottom Left: RESULTS SBH**
 - RESULT TYPE: PWRE, BS SIP, HS SIP, HP DEC, TU SIP, BIT
 - COUNTS: HS-REI, HF-REI, LP-REI
 - AU POINTER: 0
 - TU POINTER: 0
 - SLAPSED TIME: ..0 ..h ..m ..s
- Bottom Right: FUNCTION**
 - STORAGE: STOR0
 - STORED SETTING NUMBER: 0
 - SETTING: 0 (FACTORY DEFAULT SETTINGS), 1, 2, 3, 4

At the bottom, the STATUS bar shows: STORED SETTINGS, SETTINGS CONTROL, FLOPPY DISK, LOGGING, MORE, and SINGLE WINDOW.

Press **GRAPH** to change to the graph display

The screenshot shows the instrument's graph display. The layout is similar to the previous screen, but with a graph window in the bottom right quadrant:

- Top Left: TRANSMITTER OUTPUT SBH** (Same as previous screen)
- Top Right: RECEIVER INPUT SBH** (Same as previous screen)
- Bottom Left: RESULTS SBH** (Same as previous screen)
- Bottom Right: GRAPH**
 - BIT ERROR COUNT: 60
 - TIME: 00:00
 - Y-axis: BIT ERROR COUNT (0 to 60)
 - X-axis: TIME (00:00, 00:00, 00:00)
 - Legend: POLY, LUT, LUT, LUT, LUT, LUT, LUT, LUT, LUT, LUT

Below the graph, a HINT reads: "Press SET for popup application diagram". The STATUS bar at the bottom shows: TEXT RESULTS, ZOOM IN, CHANGE UPPER, CHANGE LOWER, PRINT, and SINGLE WINDOW.

Getting Started
Selecting Displays

Changing the Displayed Folder

Many windows displayed with the **TRANSMIT** ; **RECEIVE** ;and **RESULTS** keys contain a number of “folders” which may be selected with **→** and **←** .

For example, in the display given below there are five “folders” MAIN SETTINGS, STRUCT'D SETTINGS, JITTER and TEST FUNCTION. In this example MAIN SETTINGS is the current selection.



Example:

To change the PDH display shown from MAIN SETTINGS to STRUCTURED SETTINGS.







Use **→**.



Changing the Instrument Settings

Settings which may be changed are displayed in a different color to those which are fixed. In this manual, variable settings are shown on the displays in [].

In each of the display areas the field currently able to be changed is marked by a highlighted cursor.

The highlighted cursor is moved around the display using    and .

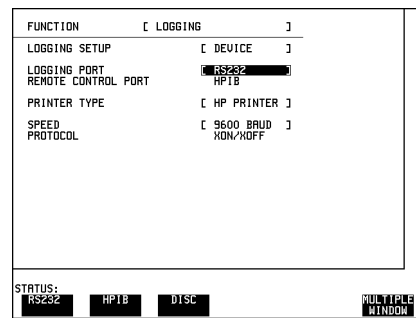

The menu of selections available, for the highlighted field, appears at the bottom of the display: **RS232**; **HP1B**; **DISK**. The choice from the menu is made using the display softkeys situated immediately below the display.

When a field has more than five choices, as in SPEED shown here, a softkey labelled **MORE** is provided.

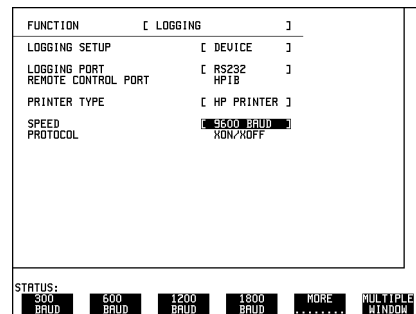

Getting Started

Changing the Instrument Settings

When **MORE** is chosen the remainder of the menu is revealed.

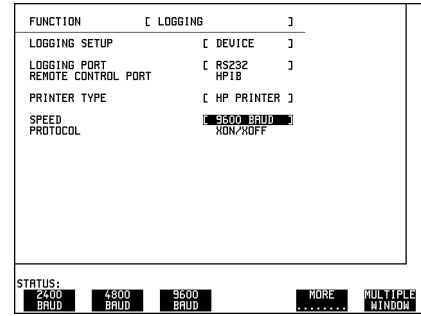

Getting Started
Changing the Instrument Settings

Modifying Displays with Pop-up Menus

Although the method of modifying the displays with softkeys is always available, it is easier in many cases to use the Pop-up menus.

The pop-up menus are particularly useful for:

- Text entry
- Date/time entry
- Integer, Hexadecimal and Binary entry
- Trace data entry
- Menu selection when there are a large number of choices
- SDH/SONET payload mapping
- ATM physical and adaptation layer selections
- Jitter mask selections

If an attempt is made to set out of range values, the instrument will adopt the nearest possible legal value.

Text, Trace Data, Date and Time, Integer and Hexadecimal Selection.

Move the cursor to the field to be changed.

Press **SET** for the pop-up menu.

The current selection is shown in a window at the top of the pop-up menu.



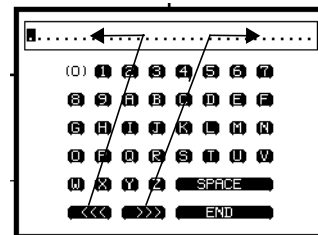

To move through the current setting in the window use **↓**, **↑**, **→** and **←** to select **<<<** or **>>>**.

Use **SET** to move to the required field.



Getting Started

Changing the Instrument Settings

Select the required character or function on the pop-up menu with    and .

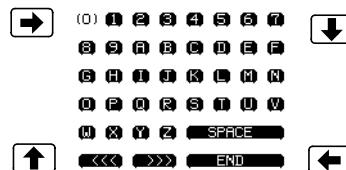

Press **SET** to set the selection in the window at the top of the pop-up menu.

When the required content is displayed in the window at the top of the pop-up menu, select **END** and press **SET** to change the instrument setting to the new value.

To exit the menu display without making the change, press **CANCEL**.

Example:

The pop-up menu provides a more convenient method of entering stored setting titles. Move the cursor into one of the title fields and press **SET**.

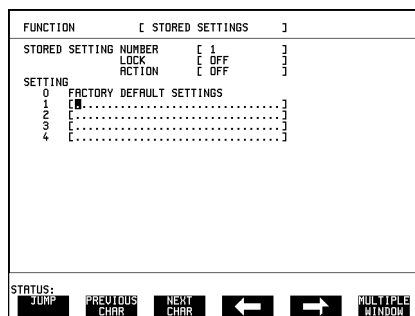

SET

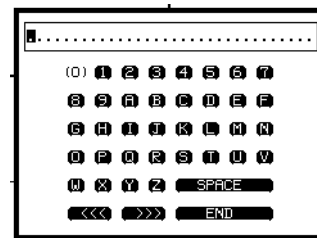

Getting Started
Changing the Instrument Settings

Binary Entry

For fields which require binary data entry, use **SET** to display the pop-up menu.

The current setting is shown in a window at the top of the pop-up menu.

To move through the selected entry with the pop-up menu use **<<<** and **>>>** see page 16.

Binary selection is achieved with **←** = 0 and **→** = 1. This operation enters the selected character, 0 or 1, and moves to the next character.

This method allows rapid setting of binary words. For example:

To set the word 11110011 Use **→ → → → ← ← → →**.

Selection of the last character changes the instrument setting to the new value.

To exit the menu display without making the change, press **CANCEL**.

Example:

The binary pop-up menu maybe used to set up a user defined word. In this example the user defined word is an ATM payload background byte.

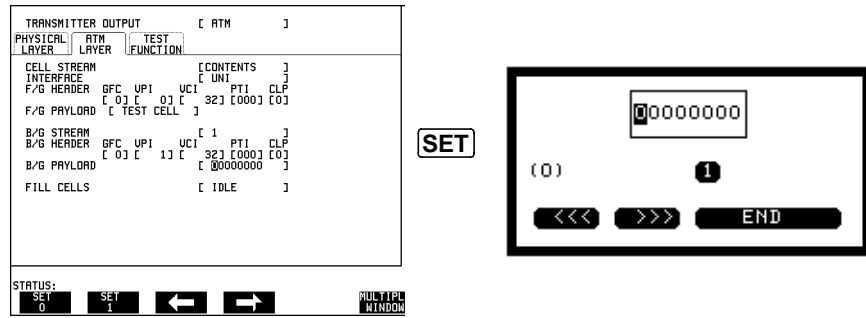

Getting Started

Changing the Instrument Settings

Menu Selection

There is a menu selection available as an alternative to any group of soft keys. Display the menu with **SET**. Use **↑** and **↓** to make the selection.

To change to the new value, press **SET**. To exit the display without making the change, press **CANCEL**.

Example:

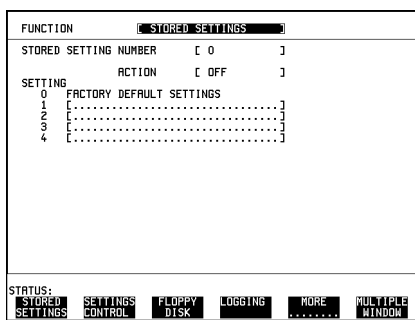

SET

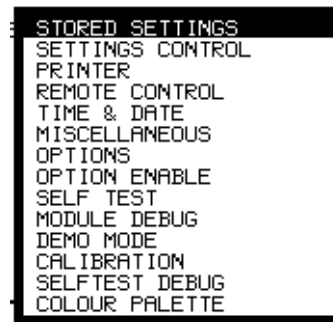

Getting Started
Changing the Instrument Settings



Making Selections using Pictorial and Graphic Displays.



In some cases selection is simplified with a pictorial or graphic "map" display. This facility is available where the display has a  symbol. These displays are obtained in the same way as the pop-up menus using **SET**. Some of these displays include menus which allow the settings to be changed.

NOTE Details of the pictorial display depend on the optional modules fitted to the instrument.

SDH Payload Mapping

With the cursor in the MAPPING field, press **SET** to display the payload map.

To change between AU- layer, TU-layer and Payload layer selections, use  and  .

To select the mapping you want, use  and  .

To change to the new value, press **SET** . To exit the map display without making the change, press **CANCEL** .

.Example:

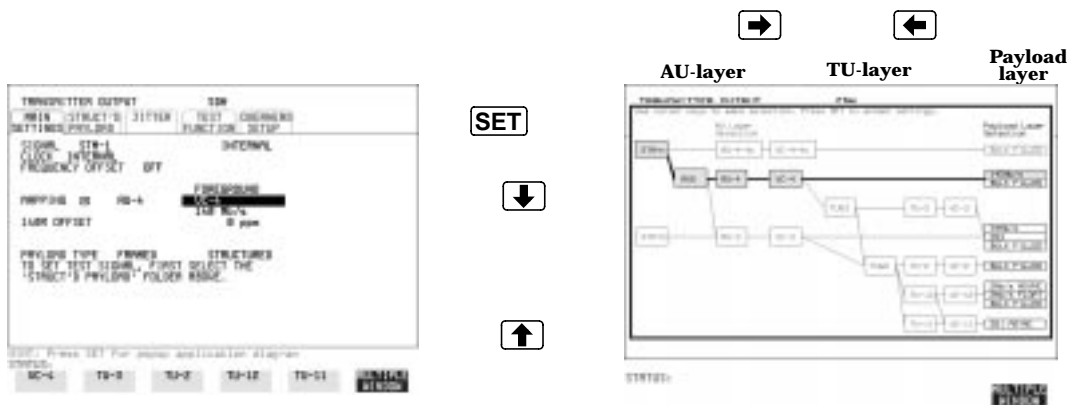

Getting Started

Changing the Instrument Settings

ATM Physical Layer Selections

With the cursor in the ATM, PHYSICAL LAYER, SIGNAL field, press **SET** to display the physical interface. Use **←** and **→** to select the interface you want.

To change to the new value, press **SET**.

To exit the map display without making the change, press **CANCEL**.

Example:

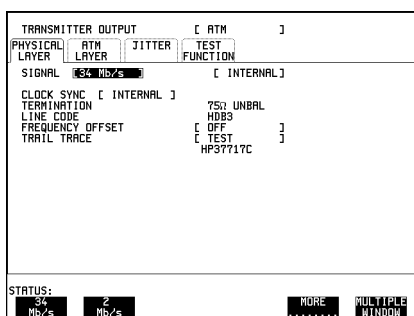

SET

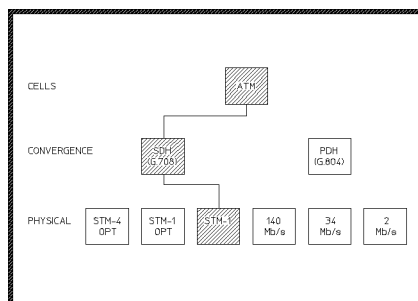

Getting Started

Changing the Instrument Settings

Jitter Mask Selection

Graphical displays of jitter mask selections are available. The current settings are shown by a marker on the graphical display.

Jitter Mask set to Off

To obtain a graphical display, move the cursor to RANGE, MODULATION FREQUENCY, or AMPLITUDE and press **SET**.

To change a value, use **←** **→** **↑** and **↓** to select the parameter you want to change, RANGE, MOD FREQ OR AMPLITUDE.

Press **SET** for a pop-up menu.

Make your selection from the pop-up menu as described in **Modifying Displays with Pop-up Menus** page 16 and press **SET** again to select the new value.

The marker on the graphical display will move to the new position and set the new value.

To exit the graphical display with the new value set, press **CANCEL**.



SET

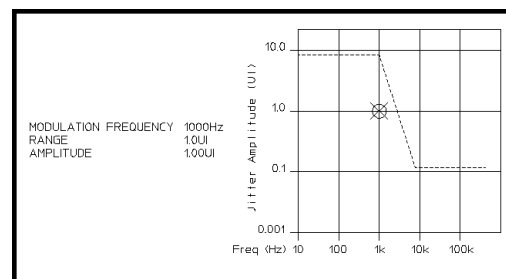

Getting Started

Changing the Instrument Settings

Jitter Mask set to Swept

To obtain a pictorial display, move the cursor to JITTER MASK [SWEPT] and press **SET**. The marker moves continuously through the sweep range.

To exit the pictorial display use **CANCEL**.

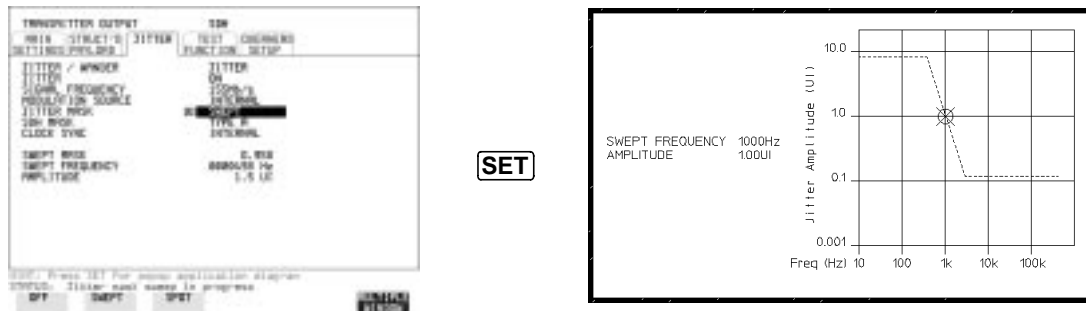

To change the frequency, press **SET** for a pop-up menu.

Use **←**, **→**, **↑** and **↓** to make your selection from the pop-up menu and press **SET** again to select the new value

To exit the graphical display with the new value set, press **CANCEL**

Getting Started Using with a Monitor

Jitter Mask set to Spot

To obtain a graphical display, move the cursor to SPOT FREQUENCY and press **SET**.

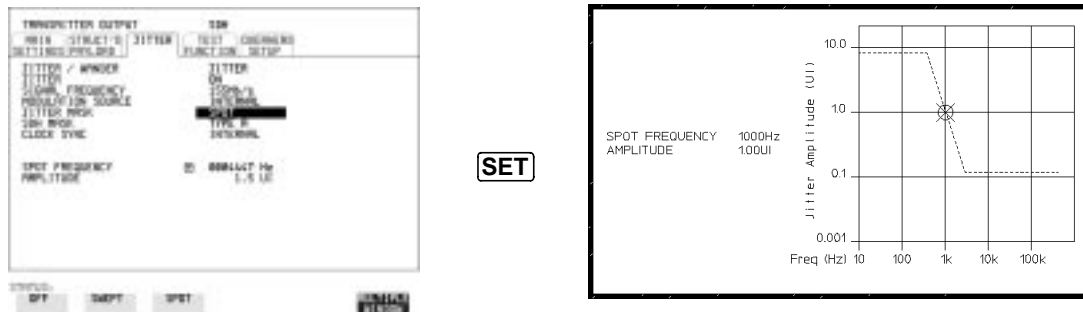

To change the frequency press **SET** for a pop-up menu of the values available.

Use **←**, **→**, **↑** and **↓** to make your selection from the pop-up menu and press **SET** again to select the new value.

The marker on the graphical display will move to the new position and update the value.

To exit the graphical display with the new value set, press **CANCEL**

Using with a Monitor

For ease of viewing at a distance, the instrument display may be presented on a monitor. The monitor should be connected to the HP 37717C front panel VGA connector.

Getting Started
Using the Other Front Panel Keys

Using the Other Front Panel Keys

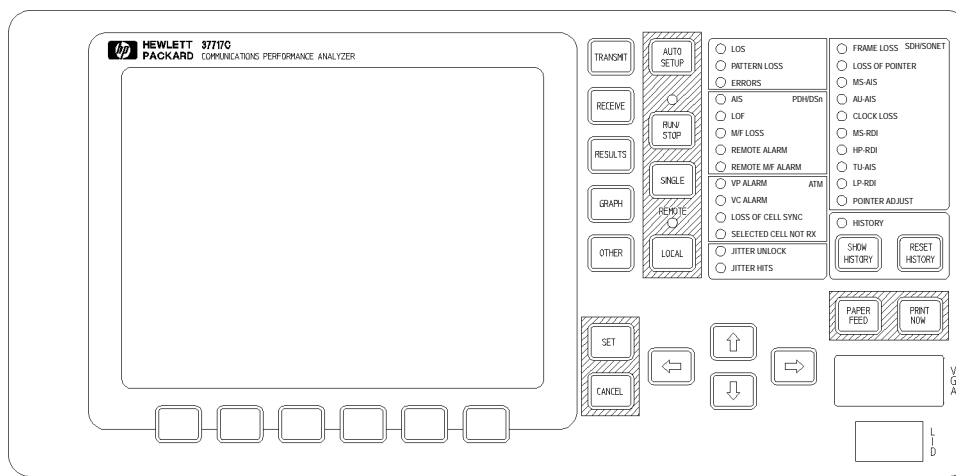

AUTO SETUP

The test set attempts to match the settings to the received signal.

RUN/STOP

Terminates the current test period if one is in progress. Starts a new test period. The indicator above the key is lit when a test period is in progress.

SINGLE

Adds a single bit error to the output data pattern each time the key is pressed.

LOCAL

Returns the instrument from remote operation to Local (keyboard) operation. The indicator above the key is lit when the instrument is under Remote Control.

SET

Displays the pop-up menu for the currently highlighted field. This key also confirms the selection made.

CANCEL

Clears the pop-up menu without changing the selection.

PRINT NOW

The selected measurement results are logged, immediately, to the selected printer.

PAPER FEED

The paper in the internal printer is advanced.

Getting Started
Using the Other Front Panel Keys

CAUTION

Do not press **PAPER FEED** while attempting to load a new roll of paper in the printer. It could result in a paper jam and disable the printer. Wait until the paper is fed through the printer mechanism before pressing **PAPER FEED**.

Monitoring Status

<input type="checkbox"/> LOSS	<input type="checkbox"/> FRAME LOSS SDH/SONET
<input type="checkbox"/> PATTERN LOSS	<input type="checkbox"/> LOSS OF POINTER
<input type="checkbox"/> ERRORS	<input type="checkbox"/> MS-AIS
<input type="checkbox"/> AIS PDH/DSn	<input type="checkbox"/> AU-AIS
<input type="checkbox"/> FRAME LOSS	<input type="checkbox"/> CLOCK LOSS
<input type="checkbox"/> M/FFRAME LOSS	<input type="checkbox"/> MS-RDI
<input type="checkbox"/> REMOTE ALARM	<input type="checkbox"/> HP-RDI
<input type="checkbox"/> REMOTE M/FFRAME ALARM	<input type="checkbox"/> TU-AIS
<input type="checkbox"/> VP ALARM ATM	<input type="checkbox"/> LP-RDI
<input type="checkbox"/> VC ALARM	<input type="checkbox"/> POINTER ADJUST
<input type="checkbox"/> LOSS OF CELLSYNC	
<input type="checkbox"/> SELECTED CELL NOT RX	
<input type="checkbox"/> JITTER UNLOCK	
<input type="checkbox"/> JITTER HITS	

Displaying Status History

The Status indicators on the front panel convey information regarding the current status of the instrument. If an alarm has occurred during the current Test Period, the indicator above **SHOW HISTORY** is lit. To view which alarms have occurred, press and hold **SHOW HISTORY**. When **SHOW HISTORY** is released the status indicators return to displaying the current status.

SHOW HISTORY

When pressed and held, the Status indicators display any alarms which have been set during the current Test Period. This continues until **SHOW HISTORY** is released at which time the current status is displayed. The indicator above the key is lit to signify that an alarm has occurred during the current Test Period.

RESET HISTORY

Resets the history store such that the historical and present status are the same. This can also be achieved by starting a new Test Period.

Getting Started
Monitoring Status

General Alarm Indicators

Loss	No data transitions at the input port.
Pattern Loss	The received data pattern is not in synchronization with the internally generated reference data.
Errors	A measured error has occurred. The indicator will remain lit for 100 ms.

PDH / DS_n Alarm Indicators

These are active when a PDH / DS_n signal is received

AIS	The All Ones AIS signal is detectable in the presence of a 1 in 10 ⁻³ error rate.
Frame Loss	Frame alignment lost or out of alignment condition.
M/Frame Loss	Multiframe alignment lost.
Remote Alarm	Remote alarm, x-bit or yellow alarm bit is set.
Remote M/ Frame Alarm	Remote Multiframe Alarm bit is set.

ATM Alarm Indicators

These are active when an ATM signal is received.

VP Alarm	Virtual Path AIS or FERF has been detected.
VC Alarm	Virtual Channel AIS or FERF has been detected.
Loss of Cell Sync	Cell Sync Loss has been detected.
Selected Cell Not RX	The selected cell has not been received. Selected cell not received.

Jitter Alarm Indicators

Jitter Unlock	The jitter receiver has lost phase lock. Jitter measurement is suspended until lock is regained.
Jitter Hits	A jitter hit has been detected.

Getting Started
Monitoring Status

SDH Alarm Indicators

These are active when an SDH signal is received.

FRAME LOSS	Loss Of Frame has been detected.
LOSS OF POINTER	Loss of pointer has been detected.
MS-AIS	Multiplexer Section AIS has been detected.
AU-AIS	Path AIS has been detected.
CLOCK LOSS	The transmitter clock is not synchronized to the selected reference.
MS-RDI	Multiplexer Section RDI (FERF) has been detected.
HP-RDI	Path RDI (FERF) has been detected.
TU-AIS	TU Path AIS has been detected. .
LP-RDI	TU Path RDI (FERF) has been detected. .
POINTER ADJUST	A pointer change in the foreground signal has been detected.

SONET Alarm Indicators (Option 120)

These are active when a SONET signal is received.

LOF/SEF	Loss of Frame or Severely Errored Frame has been detected. Status message on bottom of display states which has occurred.
LOP-P/LOP-V	Loss of Pointer has been detected.
AIS-L	Line AIS has been detected.
AIS-P	STS Path AIS has been detected.
CLOCK LOSS	The transmitter clock is not synchronized to the selected reference.
RDI-L	Line Remote Defect Indication (RDI) has been detected.
RDI-P	STS Path RDI has been detected.
AIS-V	Virtual Tributary path AIS has been detected.

Getting Started
Monitoring Status

RDI-V	VT path RDI has been detected.
POINTER ADJUST	A pointer change in the foreground signal has been detected.

Index

- A**
AIS alarm indicator, 28
Alarm Indicator
 AIS, 28
 Errors, 28
 Frame loss, 28
 HP-RDI, 29
 Jitter unlock, 28
 LOF/OOF, 29
 Loss of cell sync, 28
 LP-RDI, 29
 M/Frame loss, 28
 MS-RDI, 29
 Pattern Loss, 28
 Pointer adjust, 29
 Remote alarm, 28
 Remote M/frame alarm, 28
 Selected cell not received, 28
 Signal Loss, 28
 TU-AIS, 29
 TU-LOP, 29
 VC Alarm, 28
 VP alarm, 28
Alarm Indicators
 ATM, 28
 General, 28
 Jitter hits, 28
 PDH / DSn, 28
 SDH, 29
ATM Alarm Indicators, 28
ATM Alarms
 Loss of Cell Sync, 28
 Selected Cell Not Received, 28
 VC Alarm, 28
 VP Alarm, 28
ATM layer selections with pop-up menus, 21
AU-AIS Alarm IndicatorAlarm Indicator
 AU-AIS, 29
Auto Setup key, 25
- B**
Binary entry with pop-up menu, 18
- C**
Cancel key, 25
Changing settings on displays, 14
Changing settings with soft keys, 14
- Clock Loss Alarm IndicatorAlarm Indicator
 Clock loss, 29
Cursor
 Introduction to, 14
 Moving, 14
- D**
Date and time entry with pop-up menu, 16
Display on a monitor, 24
Displaying list of, 8
Displays
 Changing settings on, 14
DSn Alarm Indicators, 28
- E**
Errors Alarm Indicator, 28
- F**
Folder
 Selecting, 13
Frame Loss Alarm Indicator, 28
- G**
Graph key, 8
Graphic displays as a selection aid, 20
- H**
Hexadecimal entry with pop-up menu, 16
History Keys, 27
HP-RDI Alarm Indicator, 29
- I**
Indicators
 Front Panel, 28
Integer entry with pop-up menu, 16
- J**
Jitter Alarm Indicators, 28
Jitter hits alarm indicator, 28
Jitter Unlock alarm indicator, 28
- K**
Keys
 Auto Setup, 25
 Cancel, 25
 Graph, 8
 Local, 25
- Other, 8
Paper Feed, 25
Print Now, 25
Receive, 8
Reset History, 27
Results, 8
Run / Stop, 25
Set, 25
Show History, 27
Transmit, 8
- L**
Local key, 25
LOF alarm indicator, 29
Loss of Cell Sync Alarm Indicator, 28
Loss Of Pointer Alarm IndicatorAlarm Indicator
 AU-LOP, 29
LP-RDI Alarm Indicator, 29
- M**
M/Frame Loss Alarm Indicator, 28
Menus, pop-up, obtaining, 16
Monitor, connecting, 24
MS-AIS Alarm IndicatorAlarm Indicator
 MS-AIS, 29
MS-RDI Alarm Indicator, 29
Multiple windows
 Moving between, 10
 Selecting the undisplayed window, 11
Multiple/single window selection, 9
- O**
OOF alarm Indicator, 29
Options fitted, 8
Other key, 8
- P**
Paper Feed key, 25
Pattern Loss Alarm Indicator, 28
PDH / DSn Alarms
 AIS, 28
 Frame Loss, 28
 M/Frame Loss, 28
 Remote Alarm, 28
 Remote M/Frame Alarm, 28
PDH Alarm Indicators, 28
Pictorial displays as a selection aid, 20
-

Index

- Pointer Adjust Indicator, 29
- Pop-up menus
 - As alternative to soft keys, 19
 - Modifying displays with, 16
- Print Now key, 25

- R**
- Receive key, 8
- Remote Alarm Indicator, 28
- Remote M/Frame Alarm Indicator, 28
- Reset History key, 27
- Results key, 8
- Run / Stop Key, 25

- S**
- SDH Alarm Indicators, 29
- SDH Alarms
 - AU-AIS, 29
 - Clock Loss, 29
 - HP-RDI, 29
 - Loss Of Pointer, 29
 - LP-RDI, 29
 - MS-AIS, 29
 - MS-RDI, 29
 - Pointer Adjust, 29
 - TU-AIS, 29
- SDH payload mapping with pictorial display, 20
- Selectable display values, 15
- Selected Cell Not Received Alarm Indicator, 28
- Set key, 25
- Settings
 - changing with soft keys, 14
- Show History key, 27
- Signal Loss Alarm Indicator, 28
- Single/multiple window selection, 9
- Soft key alternative, pop-up menu, 19
- Soft keys
 - using, 14
- Status Indicators, 27

- T**
- Text entry with pop-up menu, 16
- Trace data entry with pop-up menu, 16
- Transmit key, 8
- TU-AIS Alarm Indicator, 29

- V**
- VC Alarm Indicator, 28
- VP Alarm Indicator, 28

Hewlett-Packard Sales and Service Offices

If you need technical assistance with a Hewlett-Packard test and measurement product or application please contact the Hewlett-Packard office or distributor in your country.

Asia Pacific:

Hong Kong:

Tel: (852) 2599 7889

India:

Tel: (91-11) 682-6000

Japan:

Hewlett-Packard Japan Ltd.
Measurement Assistance Center
9-1, Takakura-Cho, Hachioji-Shi,
Tokyo 192-8510, Japan
Tel: (81) 426-56-7832
Fax: (81) 426-56-7840

Korea:

Tel: (82-2) 769 0800

Malaysia:

Tel: (60-3) 291 0213

Philippines:

Tel: (63-2) 894 1451

People's Republic of China:

Tel: (86-10) 6505 0149

Singapore:

Tel: (1800) 292 8100

Taiwan:

Tel: (886-3) 492 9666

Thailand:

Tel: (66-2) 661 3900

For countries in Asia Pacific not listed, contact:

Hewlett-Packard Asia Pacific Ltd
17-21/F Shell Tower, Times Square,
1 Matheson Street
Causeway Bay
Hong Kong
Tel: (852) 2599 7777
Fax: (852) 2506 9285

Australia/New Zealand:

Hewlett-Packard Australia Ltd.
31-41 Joseph Street
Blackburn, Victoria 3130
Australia
Tel: 1 800 629 485

Canada:

Hewlett-Packard Canada Ltd.
5150 Spectrum Way
Mississauga, Ontario
L4W 5G1
Tel: (905) 206 4725

Europe, Africa and Middle East:

Austria:

Tel: (0)1 25000-0

Belgium and Luxembourg:

Tel: (02) 778 3417

Baltic Countries:

Tel: (358) 08872 2100

Czech Republic:

Tel: 420-2-4743111

Denmark:

Tel: 45 99 10 00

Hewlett-Packard Sales and Service Offices (cont'd)

Finland:

Tel: (90) 88 721

France:

Tel: (0)1 69.82.60.60

Germany:

Tel: (0180) 532 62-33

Greece:

Tel: 30-1-7264045

Hungary:

Tel: 36-1-4618219

Ireland:

Tel: (01) 284 4633

Israel:

Tel: 972-3-5380333

Italy:

Tel: 02 - 92 122 241

Netherlands:

Tel: (020) 547 6669

Norway:

Tel: (22) 73 57 50

Poland:

Tel: 48-22-6087700

Portugal:

Tel: (11) 482 85 00

Russia:

Tel: (7/095) 928 6885

Fax: (7/095) 916 9844

South Africa:

Tel: 27-22-8061000

Spain:

Tel: (34) 1 631 1323

Sweden:

Tel: (08) 444 22 77

Switzerland:

Tel: (01) 735 7111

Turkey:

Tel: 90-212-2245925

United Kingdom:

Tel: (01344) 366 666

***For countries in Europe/Middle East
and Africa not listed, contact:***

Hewlett-Packard
International Sales Europe
Geneva, Switzerland
Tel: +41-22-780-4111
Fax: +41-22-780-4770

Latin America:

Hewlett-Packard
Latin American Region Headquarters
5200 Blue Lagoon Drive
9th Floor
Miami, Florida 33126
U.S.A.
Tel: (305) 267-4245
Tel: (305) 267-4220
Fax: (305) 267-4288

United States:

Hewlett-Packard Company
Test and Measurement Organization
5301 Stevens Creek Blvd.
Bldg. 51L-SC
Santa Clara, CA 95052-8059
Tel: 1 800 452 4844

About This Edition

This is the 1st edition of the 37717-90401 manual. It documents the product as of March 1998. Edition dates are as follows:

1st Edition, March 1998

© Copyright Hewlett-Packard Ltd. 1998. All rights reserved. Reproduction, adaption, or translation without prior written permission is prohibited, except as allowed under the copyright laws.

In This Book

This book demonstrates the basic operation of the instrument. It tells you how to select the displays that you want and how to use them to modify the instrument functions.

This guide also tells you about the front panel key functions, the indicators and the connectors.

Printed in U.K. 03/98
37717-90401





Artisan Technology Group is your source for quality new and certified-used/pre-owned equipment

- FAST SHIPPING AND DELIVERY
- TENS OF THOUSANDS OF IN-STOCK ITEMS
- EQUIPMENT DEMOS
- HUNDREDS OF MANUFACTURERS SUPPORTED
- LEASING/MONTHLY RENTALS
- ITAR CERTIFIED SECURE ASSET SOLUTIONS

SERVICE CENTER REPAIRS

Experienced engineers and technicians on staff at our full-service, in-house repair center

*InstraView*SM REMOTE INSPECTION

Remotely inspect equipment before purchasing with our interactive website at www.instraview.com ↗

WE BUY USED EQUIPMENT

Sell your excess, underutilized, and idle used equipment. We also offer credit for buy-backs and trade-ins. www.artisanng.com/WeBuyEquipment ↗

LOOKING FOR MORE INFORMATION?

Visit us on the web at www.artisanng.com ↗ for more information on price quotations, drivers, technical specifications, manuals, and documentation

Contact us: (888) 88-SOURCE | sales@artisanng.com | www.artisanng.com