



## Artisan Technology Group is your source for quality new and certified-used/pre-owned equipment

- FAST SHIPPING AND DELIVERY
- TENS OF THOUSANDS OF IN-STOCK ITEMS
- EQUIPMENT DEMOS
- HUNDREDS OF MANUFACTURERS SUPPORTED
- LEASING/MONTHLY RENTALS
- ITAR CERTIFIED SECURE ASSET SOLUTIONS

### SERVICE CENTER REPAIRS

Experienced engineers and technicians on staff at our full-service, in-house repair center

### *InstraView*<sup>SM</sup> REMOTE INSPECTION

Remotely inspect equipment before purchasing with our interactive website at [www.instraview.com](http://www.instraview.com) ↗

### WE BUY USED EQUIPMENT

Sell your excess, underutilized, and idle used equipment. We also offer credit for buy-backs and trade-ins. [www.artisanng.com/WeBuyEquipment](http://www.artisanng.com/WeBuyEquipment) ↗

### LOOKING FOR MORE INFORMATION?

Visit us on the web at [www.artisanng.com](http://www.artisanng.com) ↗ for more information on price quotations, drivers, technical specifications, manuals, and documentation

**Contact us:** (888) 88-SOURCE | [sales@artisanng.com](mailto:sales@artisanng.com) | [www.artisanng.com](http://www.artisanng.com)

SDH Concept  
Guide

HP 37717C  
Communications  
Performance Analyzer

---

© Copyright Hewlett-Packard Ltd.1998

All rights reserved.  
Reproduction, adaption,  
or translation without prior  
written permission is  
prohibited, except as  
allowed under the  
copyright laws.

Information in this  
document may apply to  
modules which use the  
VxWORKS TM software.  
The VxWORKS TM  
software was developed by  
Wind River Systems, Inc.,  
which has copyright to it.

HP Part No. 37717-90417

First Edition, Feb 98

Printed in U.K.

## Warranty

The information contained  
in this document is subject  
to change without notice.

*Hewlett-Packard makes no  
warranty of any kind with  
regard to this material,  
including, but not limited  
to, the implied warranties  
or merchantability and  
fitness for a particular  
purpose.*

Hewlett-Packard shall not  
be liable for errors  
contained herein or for  
incidental or  
consequential damages in  
connection with the  
furnishing, performance,  
or use of this material.

## WARNING

### Warning Symbols Used on the Product



The product is marked  
with this symbol when the  
user should refer to the  
instruction manual in order  
to protect the apparatus  
against damage.

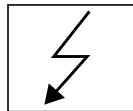

The product is marked  
with this symbol to  
indicate that hazardous  
voltages are present



EN 60825 1991

The product is marked  
with this symbol to  
indicate that a laser is  
fitted. The user should  
refer to the laser safety  
information in the  
Calibration Manual.

---

Hewlett-Packard Limited  
Telecomms Networks Test Division  
South Queensferry  
West Lothian, Scotland EH30 9TG

---

# HP 37717C Communications Performance Analyzer

---

# About This Book

The information on SDH testing in this book covers the following subjects:

- An Introduction to SDH, the SDH modules and their features.
- Measurement examples.
- Measurement result definitions
- Logging messages
- Self test error codes

For some operations and measurements, information from one of the associated books listed at the rear of this guide may be required.

---

## Contents

### **1 Introduction to SDH Testing**

- Introduction to SDH 2
- Option A3R [A3S] SDH Generation and Analysis 4

### **2 SDH Testing**

- Add/Drop Multiplexer Testing 6
- Alarm Stimulus/Response 11
- DCC Testing 15
- Desynchroniser Stress 18
- Frame Synchronization 21
- SDH Jitter Transfer 27
- MSP Stimulus/Response 30
- Optical Clock Recovery Stress 34
- Payload Mapping/Demapping 36
- Performance Monitor Stimulus / Response 42
- Selective Jitter Transfer Measurement 46
- Automatic Alarm and BIP Error Monitoring 50
- Automatic Verification of ADM Installation 53
- Verification of Protection Switching 57

### **3 Result Definitions**

- Trouble Scan 62
- Error Summary 62
- Short Term Results 63
- Cumulative Results 64
- SDH Error Analysis 65

---

## Contents

G.826 Analysis B1 BIP	65
G.826 Analysis B2 BIP	66
G.826 Analysis MS-REI	67
G.826 B3 BIP Analysis	68
G.826 HP-REI Analysis	69
G.826 HP-IEC Analysis	70
G.826 TU BIP Analysis - 34 Mb/s Payload	71
G.826 TU BIP Analysis - 2 Mb/s Payload	72
G.826 LP-REI Analysis - 34 Mb/s Payload	73
G.826 LP-REI Analysis - 2 Mb/s Payload	74
SDH Pointer Value Results	75
SDH Alarm Seconds	76
Frequency Measurement	77
Optical Power	77

## 4 SDH Logging Messages

Logging Devices	80
Results Logging	81
81	
During the Measurement Period	81
At the End of the Measurement Period	86
Bar Graph Logging	87
Graphics Text Results Logging	88
Results Snapshot Logging	89
Overhead Capture Logging	91
Overhead Snapshot Logging	92
SDH Tributary Scan Logging	93
Pointer Graph Logging	94

## **5 SDH Self Test Error Codes**

## **6 Terminology**

ETSI / ANSI Equivalent Terms 116

Current / Previous Terminology 118



---

Contents

---

# 1

Introduction to SDH page 2

37717C SDH Options page 3

---

## Introduction to SDH Testing

Information on SDH in general and the SDH test features of the HP 37717C.

## **Introduction to SDH**

Synchronous Digital Hierarchy (SDH) is an international standard (ETSI) for high speed synchronous optical telecommunications networks.

The concept of a synchronous transport system, based on SDH standards, goes beyond the basic needs of a point to point transmission system. It includes the requirements of telecommunications networking - switching, transmission and network control. These capabilities allow SDH to be used in all three traditional network application areas - Local Network, Inter-exchange Network and Long Haul Network - thus providing a unified telecommunication network structure.

The SDH standards are based on the principle of direct synchronous multiplexing. This means that individual tributary signals (Payload) may be multiplexed directly into a higher rate SDH signal without intermediate stages of multiplexing. SDH network elements, even those supplied by different manufacturers, can be interconnected directly giving cost and equipment savings.

SDH is capable of transporting all the common tributary signals E1 (2.048 Mb/s), E3 (34.368 Mb/s), E4 (139.264 Mb/s), DS1 (1.544 Mb/s) and DS3 (44.736 Mb/s) currently in use. In addition SDH has the flexibility to readily accommodate any new types of service which are being introduced for example (ATM) or which may be required in the future. Approximately 5% of the SDH signal structure (Overhead) is reserved for network management and maintenance.

This means that SDH can be deployed as an overlay to the existing network thus providing enhanced network flexibility.

The HP 37717C provides comprehensive testing of both payload and overhead at electrical and optical SDH interfaces.

---

## **37717C SDH Options**

Option A3R [A3S] SDH Generation and Analysis page 4

SDH generation and analysis with STM-0 and STM-1 electrical interfaces,  
Option A3R.

Additional SDH interface capability is provided by the following Options::

STM-1 Optical Interface, Option UH1.

STM-0, STM-1 and STM-4 optical interfaces at 1310nm, Option 131.

STM-0, STM-1 and STM-4 optical interfaces at 1310nm and 1550nm, Option 130.

STM-0, STM-1, and STM4 binary interfaces, Option 0YH

---

## Option A3R [A3S] SDH Generation and Analysis

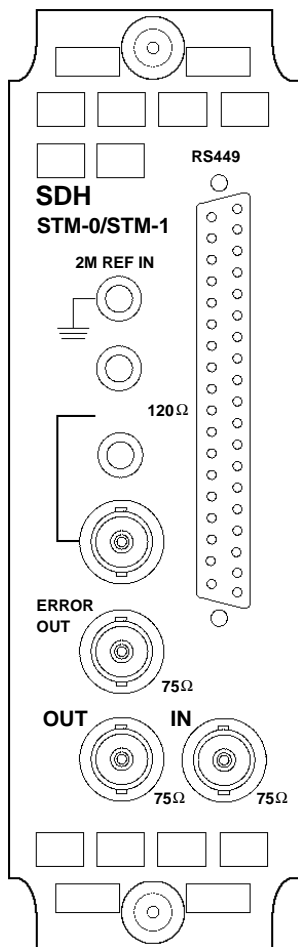

Option A3R [A3S] provides STM-0 and STM-1 Electrical interfaces.

When Option UH1 is fitted STM-1 Optical interfaces are provided.

When Option 130 or 131 is fitted STM-1 and STM-4 optical interfaces are provided.

When STM1-1 Optical is selected, the STM-1 electrical output is also active.

The THRU mode capability allows you to overwrite the TU-2, TU-3, AU-3, TU12 and AU-4 payloads and the section overhead of the incoming STM-0/STM-1/STM-4 signal.

Frequency offset of the SDH signal of 999 ppm is available.

Bulk Filled and Mixed payloads are available. If Option UKJ, Structured PDH, is fitted, DS1 and DS3 payloads are available and a 2 Mb/s, 34 Mb/s and 140 Mb/s Insert Port is provided. Bit errors can be added to the payload.Errors & Alarms can be added to the SDH signal.

AU and TU Pointer Movements can be added to the SDH signal and a Graphical display of Pointer activity is available.

Section and path Overhead bytes are user programmable and can be monitored and displayed in Hexadecimal or as 8 bit bytes. Selected overhead bytes can be transmitted with a programmed sequence of data.

Receive sequences can be captured and displayed. K4 and V5 overhead bytes can be accessed.

Allows BER testing of section and path overhead bytes.

Allows testing of MSP Linear and Ring architectures.

DCC Drop and Insert capability is included.

Allows Protection Switch time testing if Option UKJ, Structured PDH, is fitted.

Optical Power measurement is available.

Optical Clock stress capability at STM-1 and STM-4 is included.

Provides SDH Alarm Scan and Tributary Scan.

### Option A3R

---

## 2

Add/Drop Multiplexer Testing	page 6
Alarm Stimulus/Response	page 11
DCC Testing	page 15
Desynchroniser Stress	page 18
Frame Synchronization	page 21
SDH Jitter Transfer	page 27
MSP Stimulus/Response	page 30
Optical Clock Recovery Stress	page 34
Payload Mapping/Demapping	page 36
Performance Monitor Stimulus / Response	page 42
Selective Jitter Transfer Measurement	page 46
Automatic Alarm and BIP Error Monitoring	page 50
Automatic Verification of ADM Installation	page 53
Verification of Protection Switching	page 57

---

## SDH Testing

This Chapter gives examples of the instrument operation in typical SDH test applications.

---

## **Add/Drop Multiplexer Testing**

### **Application**

The insertion of tributary signals into the Add/Drop multiplexer, which are then mapped into the SDH signal, should take place without introducing errors. The insertion and mapping process is tested by adding a test pattern to the tributary inserted at the tributary insert port. At the SDH side of the Add/Drop multiplexer the tributary is demapped by the HP 37717C Communications Performance Analyzer. By using the Optical Splitter, at the optical side of the Add/Drop multiplexer, the Add/Drop multiplexer need not be taken out of service. A Bit error rate (BER) test is performed on the recovered tributary test pattern to determine whether errors have been introduced by the Add/Drop multiplexer.

### **Default (Known State) Settings**

It is advisable to set the HP 37717C to a known state before setting up a measurement. This clears all previous settings and provides a clearly defined instrument state. The default settings are set by selecting **OTHER STORED SETTINGS** STORED SETTING NUMBER 0 and pressing **RECALL**

### **Add/Drop Multiplexer Testing Test Setup Procedure**

The following Options must be fitted to the HP 37717C to perform this test :

- UKJ [USA]or UKK [USB] - PDH Module
- A3R [A3S] - SDH Module
- 130 or 131 - STM-0/1/4 Optical Interface

In this setup a 2 Mb/s payload, containing a test pattern, is inserted at the tributary insert port of the Add/Drop multiplexer multiplexer. A portion of the STM4 Optical signal is tapped off by the Optical Splitter (approx 10%) and the 2 Mb/s tributary is demapped by the HP 37717C Communications Performance Analyzer.

An Error measurement is performed on the demapped 2 Mb/s tributary test pattern.

A SINGLE test period of 24 HOURS is used and the internal printer is enabled to record results and alarms.

The HP 37717C Communications Performance Analyzer GRAPHICS function is enabled. The graphical results can be viewed on the **GRAPH** display

## SDH Testing Add/Drop Multiplexer Testing

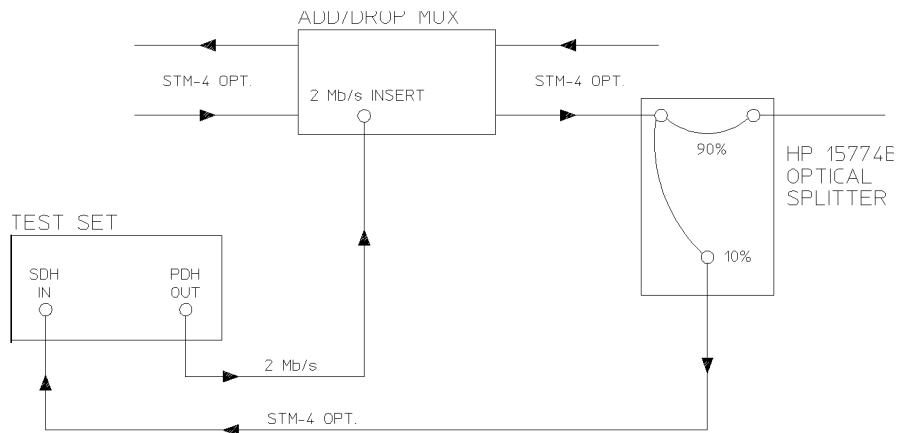

1. Connect the HP 37717C to the network equipment and set the **OTHER** **SETTINGS CONTROL** TRANSMITTER AND RECEIVER to INDEPENDENT.

Changes made on the **TRANSMIT** display will not affect the **RECEIVE** display and changes made on the **RECEIVE** display will not affect the **TRANSMIT** display.

2. Set up the **TRANSMIT** display as shown opposite.

The PAYLOAD TYPE determines the Framing .

TRANSMITTER OUTPUT	[ PDH ]
STRUCTURE	[ STRUCT B ]
JITTER	[ TEST ]
FUNCTION	[ FUNCTION ]
SIGNAL	[ 2 Mb/s ]
CLOCK SYNC	[ INTERNAL ]
TERMINATION	[ 75% UNBAL ]
LINE CODE	[ HDB3 ]
FREQUENCY OFFSET	[ OFF ]
PAYLOAD TYPE	[ PCM30CRC ]
PATTERN	[ 2 <sup>11</sup> -1 PRBS ]
PRBS POLARITY	[ INU ] NON-ITU ]
2M CR5 ABCD BITS	[ 1111 ]
STATUS:	
<b>MULTIPLE WINDOW</b>	



## SDH Testing

### Add/Drop Multiplexer Testing

3. Set up the **RECEIVE** display as shown opposite.

RECEIVER INPUT	[ SDH ]
SDH	STRUCT'D TEST OVERHEAD
PAYLOAD	FUNCTION MONITOR
SIGNAL [STM-4 OPT]	
MAPPING [ AU-4 ] [ TU-12 ]	
	[ ASYNC 2Mb/s ]
CHANNEL	STM-1 TUG3 TUG2 TU
	[ 1 ] [ 1 ] [ 1 ] [ 1 ]
TU PAYLOAD	[ PCM30CRC ]
PATTERN	[ 2 <sup>11</sup> -1 PRBS ] [ INVERT ] NON-ITU
STATUS:	
	MULTIPLE WINDOW

### Continuity Check

Before running the test carry out a continuity test to verify the measurement path.

1. Set up the **RESULTS** display as shown opposite.

2. Press **RUN/STOP** to start a measurement.

3. Press error add **SINGLE** three times and check that the errors are recorded on the **RESULTS** display.

3. Check that the errors are recorded on the **RESULTS** display.

4. Press **RUN/STOP** to stop the measurement.

RESULTS	[ PDH PAYLOAD ] [ CUMULATIVE ]
BIT	FAS CRC REBE
	2 Mb/s
BIT EC	
BIT ER	
ELAPSED TIME	
STATUS:	
	MULTIPLE WINDOW

Select the required logging DEVICE and set up the **OTHER** display: **LOGGING** function, as shown opposite.

FUNCTION	[ LOGGING ]
LOGGING SETUP	[ CONTROL ]
LOGGING PERIOD	[ ON ]
	[ 1 HOUR ]
RESULTS LOGGED	[ SELECTED ]
WHEN	[ PERIOD ECND ]
CONTENT	[ ER & ANRL ]
	[ PER & CUMUL ]
LOG ERROR SECONDS	[ OFF ]
LOG AT END OF TEST	[ ALL RESULTS ]
LOG ON DEMAND	RESULTS
STATUS:	
ALWAYS	PERIOD EC > 0
	MULTIPLE WINDOW

## SDH Testing

### Add/Drop Multiplexer Testing

#### Start the Add/Drop Multiplexer Test

1. Set up the **RESULTS** display as shown opposite. If you do not require stored graphics results select STORAGE [OFF].

Graphics results can be stored to the instrument store - INTERNAL or to DISK.

SHORT TERM PERIOD need only be set if it is intended to view Short Term results.

2. Press **RUN/STOP** to start the measurement.

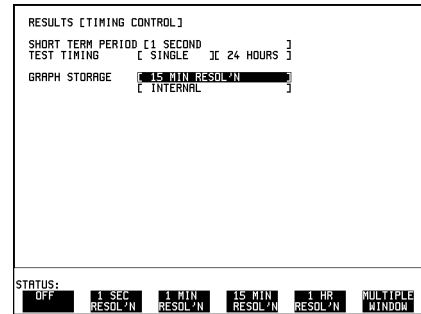

The measurement results and alarms are available on the **RESULTS** display during the test period.

The graphical measurement results and alarms are stored in non volatile memory for viewing later on the GRAPH display.

The test can be halted at any time by pressing **RUN/STOP**

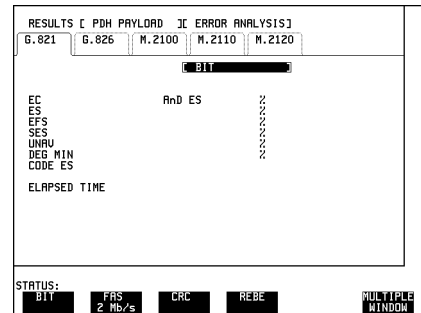

## SDH Testing

### Add/Drop Multiplexer Testing

#### At the End of the Test (Add/Drop Multiplexer Testing)

- The Date and Time the test started and the instrument setup are logged To the selected logging device.
- Results are logged To the selected logging device at 1 hour intervals if the error count is greater than 0.
- Any alarms which occur during the test period will be logged To the selected logging device.
- At the end of the test period a complete set of cumulative results are logged To the selected logging device.
- A graphical record of the results during the test period can be viewed on the **GRAPH** display. If a printer option is fitted the graph results can be logged to a printer, at a later date.
- Results and Alarm summaries can be viewed on the **GRAPH** display.

The total graphics store capacity is normally 20,000 events. An event is the occurrence of an error or an alarm.

The resolution, determined by the selection made under STORAGE on the **RESULTS** display, affects the ZOOM capability when viewing the bar graphs. If 1 SECOND is selected all resolutions are available under ZOOM. If 1 MIN is selected only 1 MIN/BAR, 15 MINS/BAR and 60 MINS/BAR are available. If 15 MINS is selected only 15 MINS/BAR and 60 MINS/BAR are available. If 1 HOUR is selected only 60 MINS/BAR is available.

Up to 10 sets of graphical results can be stored. If an attempt is made to store more than 10 sets of results, then a first in first out policy is operated and the oldest set of results will be lost. If graphics are enabled and a test is run which exceeds the remaining storage capacity, then some previously stored graphical results will be lost.

To prevent accidental overwriting of previously stored results the graphics capability should be disabled, when graphical results are not required, by selecting STORAGE [OFF] on the **RESULTS** display.

## **Alarm Stimulus/Response**

### **Application**

SDH Network elements transmit alarms in response to certain error/alarm conditions to advise upstream and downstream equipment that these conditions exist. If these alarms are not transmitted in the proper manner, at the proper time, degradations in service will occur.

Alarm testing entails transmitting an alarm signal from the Communications Performance Analyzer and monitoring the network equipment alarm indicators and the upstream or downstream signal for the correct response.

### **Default (Known State) Settings**

It is advisable to set the HP 37717C to a known state before setting up a measurement. This clears all previous settings and provides a clearly defined instrument state. The default settings are set by selecting **OTHER STORED SETTINGS** STORED SETTING NUMBER 0 and pressing **RECALL**.

### **Alarm Stimulus/Response Test Setup Procedure**

The following options must be fitted to the HP 37717C to perform this test:

- A3R [A3S] - SDH module
- UH1, - STM-1 Optical interface or 130 or 131 STM-0/1/4 Optical interface

In this setup the Communications Performance Analyzer transmits MS-AIS Alarm (Line AIS) into the network. The network equipment alarm indicators are monitored for the appropriate alarms. The upstream signal is monitored for occurrences of MS-RDI . The downstream signal can be monitored for occurrences of AU-AIS.

A similar procedure can be used for testing all other SDH alarms. See the following tables.

SDH Testing  
**Alarm Stimulus/Response**

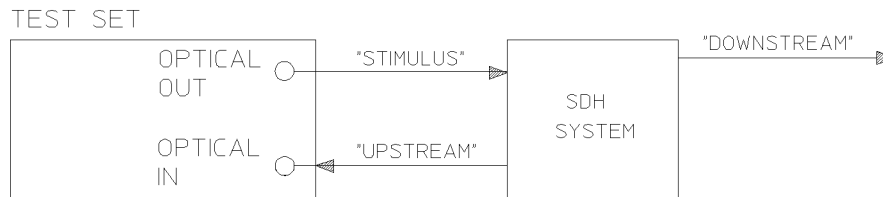

**SDH Alarms**

Alarm	RSTE		MSTE		PTE	
	Down	Up	Down	Up	Down	Up
Loss Of Signal	MS-AIS	N/A	AU-AIS	MS-RDI	TU-AIS	LP-RDI
Loss Of Frame	MS-AIS	N/A	AU-AIS	MS-RDI	TU-AIS	LP-RDI
Loss Of Pointer	N/A	N/A	AU-AIS	MS-RDI	TU-AIS	LP-RDI
MS-AIS	N/A	N/A	AU-AIS	MS-RDI	TU-AIS	LP-RDI
MS-RDI	N/A	N/A	N/A	N/A	N/A	N/A

## SDH Testing Alarm Stimulus/Response

1. Set up the **OTHER**; **SETTINGS CONTROL** display as shown opposite.

Any changes made on the **TRANSMIT** or **RECEIVE** display will affect the other.

FUNCTION [ SETTINGS CONTROL ]	
TRANSMITTER AND RECEIVER [ COUPLED ]	
RECEIVER COUPLED TO TRANSMITTER	
STATUS:	
INDEPENDENT	COUPLED
MULTIPLE WINDOW	

2. Set up the **TRANSMIT**; **SDH** display as shown opposite.

TRANSMITTER OUTPUT [ SDH ]				
SDH	STRUCT'D	JITTER	TEST	OVERHEAD
PAYLOAD	FUNCTION	SETUP		
SIGNAL [ STM-1 OPT ]		1310	[ INTERNAL ]	
CLOCK [ INTERNAL ]			OFFSET [ OFF ]	
MAPPING		AU-4	[ FOREGROUND ]	
140M OFFSET			[ UC-4 ]	
			[ 140 Mb/s ]	
			[ 0 ppm ]	
PAYLOAD TYPE			[ UNFRAMED ]	
PATTERN [ 2^23-1 PRBS ]			[ INVERT ]	ITU
STATUS:		MULTIPLE WINDOW		

3. Set up the **TRANSMIT**; **TEST FUNCTION** display as shown opposite.

The ERROR ADD TYPE selected does not matter as long as RATE [OFF] is selected.

TRANSMITTER OUTPUT [ SDH ]			
SDH	JITTER	TEST	OVERHEAD
	FUNCTION	SETUP	
TEST FUNCTION [ SDH ]		[ ERR & ALARM ]	
ERROR ADD TYPE		[ ALI2 FRAME ]	
RATE		[ OFF ]	
ALARM TYPE		[ MS AIS ]	
STATUS:		MS AIS	MS FERF
		LOSS OF POINTER	PATH AIS
		MORE .....	MULTIPLE WINDOW

## SDH Testing

### Alarm Stimulus/Response

4. Set up the **RESULTS** display as shown opposite

SHORT TERM PERIOD need only be set if it is intended to view Short Term results

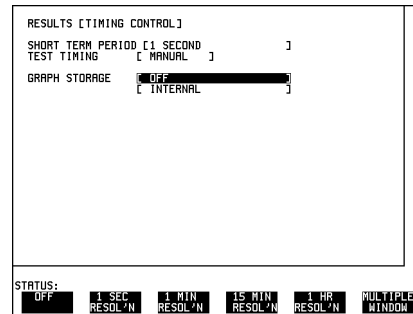

### Start the Alarm Stimulus/Response Test

1. Connect the Communications Performance Analyzer to the upstream port of the network equipment and press **RUN/STOP** on the HP 37717C.

2. Check that the network equipment registers MS-AIS and that MS-RDI alarm seconds are recorded on the **RESULTS** display .

ALARM SECONDS are displayed but any of the other results can be selected from the softkey menu without affecting the measurement

The MS-RDI indicator on the front panel in conjunction with **SHOW HISTORY** will also give an indication that the MS-RDI alarm has occurred.

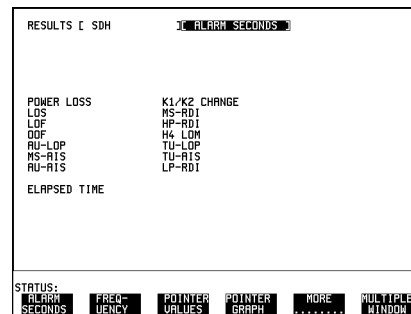

SDH Testing  
**DCC Testing**

---

## **DCC Testing**

### **Application**

The section overhead contains two Data Communication Channels (DCC), Regenerator Section DCC at 192 kb/s (overhead bytes D1- D3) and Multiplexer Section DCC at 576 kb/s (overhead bytes D4 - D12). The DCC communicates network management messages between network elements and the network controller via the operations support computer system.

If the DCC is not operating correctly these network management messages will be lost and degradations in network performance will pass unnoticed. This may result in a failure condition.

Full testing of the line and section DCC's can be carried out using a protocol analyzer connected via the HP 37717C Communications Performance Analyzer to the appropriate overhead bytes. At the far end the HP 37717C Communications Performance Analyzer can drop the selected DCC to the protocol analyzer allowing the DCC integrity to be analyzed.

If you do not have access to a protocol analyzer capable of handling SDH DCC protocol, the DCC integrity can be verified by a BER test using an HP 37732A, Digital Telecomm/Datacomm Analyzer.

### **Default (Known State) Settings**

It is advisable to set the HP 37717C to a known state prior to setting up a measurement. This clears all previous settings and provides a clearly defined instrument state. The default settings are set by selecting **OTHER STORED SETTINGS** STORED SETTING NUMBER 0 and pressing **RECALL**

### **DCC Test Setup Procedure**

#### **Alarm Stimulus/Response Test Setup Procedure**

The following options must be fitted to the HP 37717C to perform this test:

- A3R [A3S]- SDH module
- UH1, - STM-1 Optical interface or 130 or 131 STM-0/1/4 Optical interface

In this procedure the HP 37717C Communications Performance Analyzer accepts a 576 kb/s test pattern via the protocol analyzer port, inserting the test pattern in bytes D4 - D12 of the Multiplexer Section overhead and transmitting an STM-1 optical



## SDH Testing DCC Testing

signal. The HP 37717C Communications Performance Analyzer receives the STM-1 optical signal and drops the Multiplexer Section DCC, via the protocol analyzer port, to the HP 37732A which performs the BER measurement.

HP 37732A DIGITAL  
TELECOMM/DATACOMM  
ANALYSER

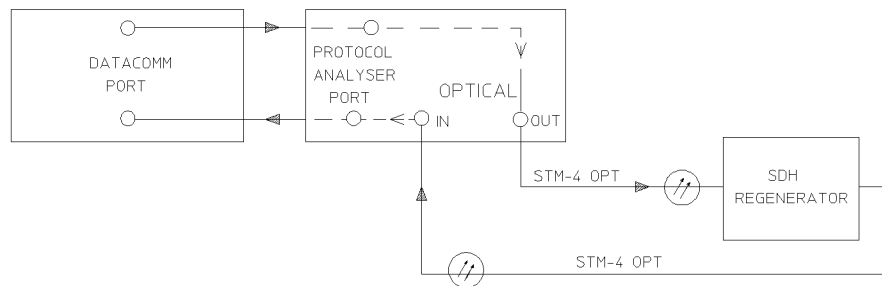

1. Connect the HP 37732A and the HP 37717C to the network element, as shown and set up the **OTHER**; **SETTINGS CONTROL** display as shown opposite.

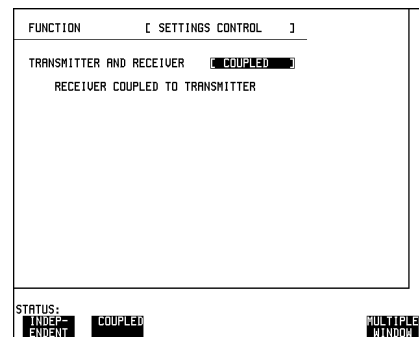

2. Set up the **TRANSMIT** SDH display as shown opposite.

The **CLOCK SYNC** selection determines the synchronization source for the **TRANSMIT** clock. If **EXTERNAL MTS** is selected a 2 Mb/s reference must be connected to the front panel 2M REF IN port. The format can be **CLOCK** or **DATA**.

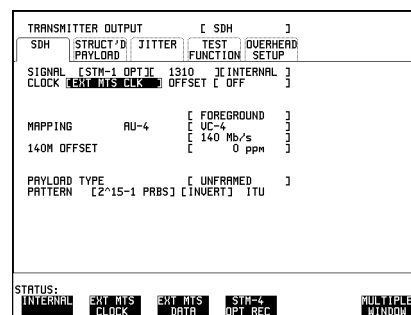

SDH Testing  
**DCC Testing**

3. Set up the **TRANSMIT**; TEST FUNCTION display as shown opposite.

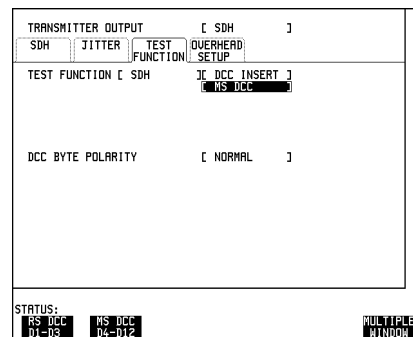

4. Set up the **RECEIVE**; TEST FUNCTION display as shown opposite.

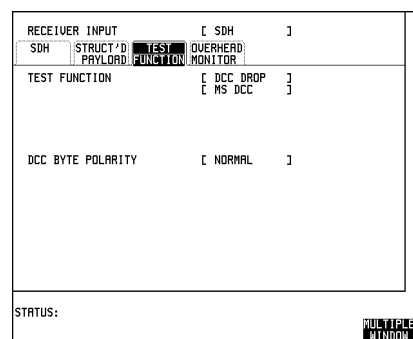

**Start the DCC Test**

1. Select TEST SELECT DATACOM on the HP 37732A.
2. Set TX Clock Source and RX Clock Source to [INTERFACE] on the HP 37732A (Clock from HP 37717C protocol port).
3. Select the required pattern and monitor logic errors and frequency to verify the integrity of the DCC.

## **Desynchroniser Stress**

### **Application**

At the boundary of the SDH network the 2 Mb/s or 140 Mb/s payload is demapped from the SDH signal. Pointer adjustments in the signal may cause high levels of tributary jitter in the output payload. Excessive amounts of tributary jitter will result in errors.

The desynchronizing phase lock loop of the network element should minimize the level of tributary jitter in the payload but correct operation under stress conditions must be verified. The desynchronizing phase lock loop can be stressed by adding pointer movement sequences (defined in CCITT standard G.783) to the SDH signal such that the test virtual container moves with respect to the SDH frame.

A jitter measurement is made to verify that the desynchroniser output jitter is within the required specification.

### **Default (Known State) Settings**

It is advisable to set the HP 37717C to a known state before setting up a measurement. This clears all previous settings and provides a clearly defined instrument state. The default settings are set by selecting **OTHER STORED SETTINGS** STORED SETTING NUMBER 0 and pressing **RECALL**.

### **Desynchroniser Stress Test Setup Procedure**

The following options must be fitted to the HP 37717C to perform this test:

- UKK [USB] or UKJ [USA]- PDH module
- A3L, A3V or A3N - Jitter measurement module
- A3R [A3S]- SDH module
- 130 or 131 STM-0/1/4 Optical interface

The HP 37717C Communications Performance Analyzer transmits an STM-4 optical signal carrying 2 Mb/s payload. Pointer movement sequences are added in a controlled manner. The desynchroniser output is returned to the HP 37717C and a jitter measurement is performed on the demapped 2 Mb/s signal.

## SDH Testing Desynchroniser Stress

TEST SET

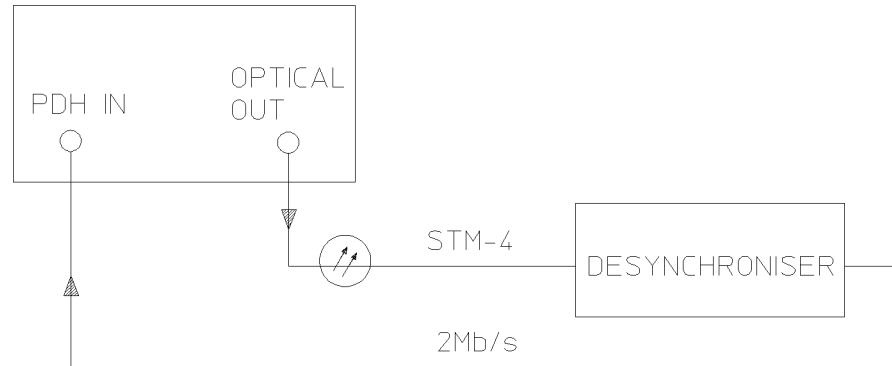

1. Connect the HP 37717C to the network equipment and set up the **TRANSMIT**; **SDH** display as shown opposite. The **CLOCK SYNC** selection determines the synchronization source for the **TRANSMIT** clock. If **EXTERNAL MTS** is selected a 2 Mb/s reference must be connected to the 2M REF IN port. The format can be **CLOCK** or **DATA**.

TRANSMITTER OUTPUT		[ SDH ]
SDH	STRUCT'D	JITTER
PAYLOAD	TEST	OVERHEAD
	FUNCTION	SETUP
SIGNAL [ STM-4 OPTIC ] 1310 [ INTERNAL ]		
CLOCK [ EXT MTS CLK ] OFFSET [ OFF ]		
MAPPING [ AU-4 ] [ TU-12 ]		
2M OFFSET [ ASYNC 2Mb/s ]		
CHANNEL STM-1 TUG3 TUG2 TU		
TU PAYLOAD [ 1 ] [ 1 ] [ 1 ] [ 1 ]		
TU PAYLOAD [ UNFRAMED ]		
PATTERN [ 2*15-1 PRBS ] [ INVERT ] ITU		
STATUS:		
B/B MAPPING MULTIPLE WINDOW		

2. Set up the **TRANSMIT**; **TEST FUNCTION** display as shown opposite.

Pointer adjustments are made every 10 ms with an extra **ADDED** adjustment as defined in CCITT standard G.783.

Pointer sequences are started by selecting **STARTED**.

TRANSMITTER OUTPUT		[ SDH ]
SDH	JITTER	TEST
	FUNCTION	OVERHEAD
	SETUP	
TEST FUNCTION [ SDH ] [ ADJUST PTR ]		
POINTER TYPE [ TU POINTER ]		
ADJUSTMENT TYPE [ G.783 ]		
[ SINGLE ]		
[ WITH ADDED ]		
POLARITY [ POSITIVE ]		
INTERVAL [ 10 MS ]		
POINTER SEQUENCES [ STOPPED ]		
STATUS:		
NEGATIVE POSITIVE MULTIPLE WINDOW		

## SDH Testing Desynchroniser Stress

3. Set up the **RECEIVE**; **PDH** JITTER display as shown opposite.

SHORT TERM PERIOD need only be set if it is intended to view Short Term results

RECEIVER INPUT	[ PDH ]
MAIN SETTINGS	STRUCT'D JITTER
SIGNAL FREQUENCY 2 Mb/s	
RECEIVER RANGE	[ 1.6 UI ]
HIT THRESHOLD	[ 0.50 UI ]
FILTER	[ OFF ]
ADDITIONAL RMS FILTER	[ OFF ]
WANDER	[ ON ]
WANDER REFERENCE	[ 75% UNBAL ]
WANDER REF. FORMAT	[ HDB3 DATA ]
CONNECT 2Mb/s SOURCE to JITTER RX MODULE	
STATUS: <b>MULTIPLE WINDOW</b>	

4. Set up the **RESULTS** display as shown opposite. .

RESULTS [TIMING CONTROL]	
SHORT TERM PERIOD	[ 1 SECOND ]
TEST TIMING	[ MANUAL ]
GRAPH STORAGE	[ OFF ]
	[ INTERNAL ]
STATUS: <b>OFF</b>   1 SEC RESOL'N   1 MIN RESOL'N   15 MIN RESOL'N   1 HR RESOL'N   <b>MULTIPLE WINDOW</b>	

### Start the Desynchroniser Stress Test

1. Press **RUN/STOP** to start the Jitter measurement.

Jitter Hits or any other result can also be viewed without affecting the measurement

RESULTS [ JITTER ]	[ CUMULATIVE ]
HITS	<b>AMPLITUDE</b>
+VE PEAK UI	
-VE PEAK UI	
PEAK-PEAK UI	
FILTERS	OFF
ELAPSED TIME	
STATUS: <b>MULTIPLE WINDOW</b>	

## Frame Synchronization

### Application

A network element should maintain synchronization even in the presence of some frame errors. If the number of frame errors exceeds the specified threshold for 3 ms, the network element will lose frame synchronization causing a new search for frame alignment to begin.

The frame synchronization process of the network element can be stressed by injecting frame errors, into the A1 and A2 framing bytes of the Regenerator Section overhead. As the frame error injection rate is increased to the frame synchronization threshold, the network element should indicate Out Of Frame (OOF) and Loss Of Frame (LOF) conditions. As the frame error injection rate is decreased again, the network element should regain frame synchronization.

### Default (Known State) Settings

It is advisable to set the HP 37717C to a known state before setting up a measurement. This clears all previous settings and provides a clearly defined instrument state. The default settings are set by selecting **OTHER STORED SETTINGS** STORED SETTING NUMBER 0 and pressing **RECALL**.

### Frame Synchronization Test Setup Procedure

**Frame Error Add Test Function** In this setup the HP 37717C Communications Performance Analyzer is used to insert frame errors in the A1 and A2, framing bytes of the Regenerator section overhead of an STM-1 optical signal. The STM-1 optical signal is transmitted to the network equipment. The network equipment OOF and LOF alarms are monitored as the frame error add rate is increased and decreased.

### Sequence Generation Test Function

In this setup procedure the HP 37717C Communications Performance Analyzer generates a sequence of errored framing bytes to test the OOF and LOF alarm threshold criteria. The upstream STM-1 optical signal is monitored for occurrences of Multiplexer Section FERF. The downstream STM-1 optical signal can be monitored for AIS.

## SDH Testing Frame Synchronization

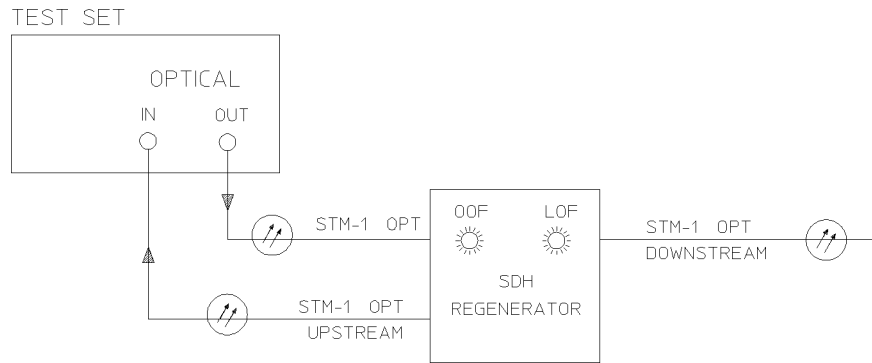

1. Connect the HP 37717C to the network equipment and set up the **OTHER**; **SETTINGS CONTROL** display as shown opposite.

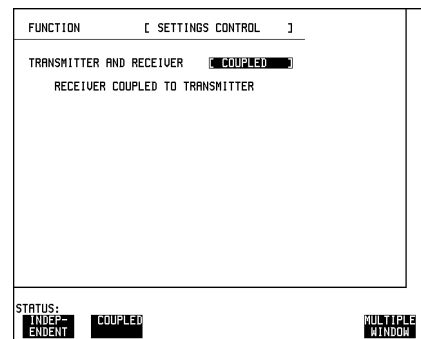

2. Set up the **TRANSMIT**; **SDH** display as shown opposite.

The **CLOCK SYNC** selection determines the synchronization source for the **TRANSMIT** clock. If **EXTERNAL MTS** is selected a 2 Mb/s reference must be connected to the front panel 2M REF IN port. The format can be **CLOCK** or **DATA**.

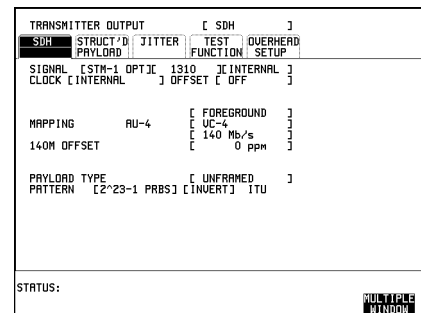

## SDH Testing Frame Synchronization

3. Set up the **RESULTS** display as shown opposite

SHORT TERM PERIOD need only be set if it is intended to view Short Term results.

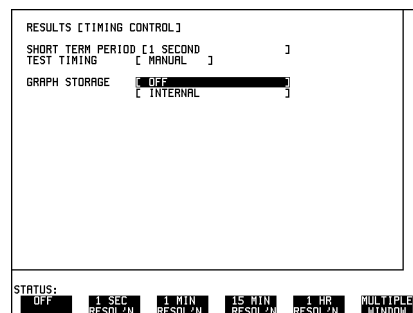

4. ALARM SECONDS are displayed but any of the other results can be selected from the softkey menu without affecting the measurement

The MS-RDI indicator on the front panel in conjunction with **SHOW HISTORY** will also give an indication that the MS-RDI alarm has occurred.

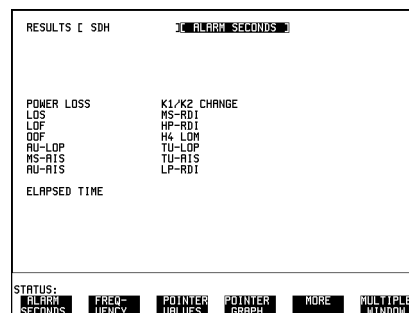

5. Set up the **TRANSMIT**; TEST FUNCTION display as shown opposite.

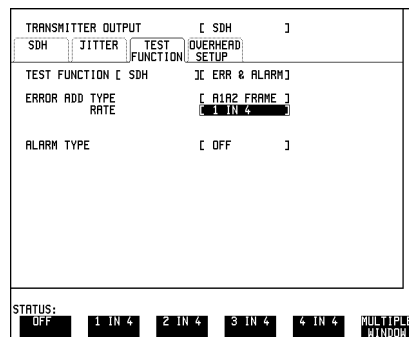



## SDH Testing

### Frame Synchronization

#### Start the Frame Synchronization Test (Frame Error Add)

1. Check that the Loss Of Frame (LOF) alarm indicator on the network element remains unlit and no occurrences of MS-RDI are recorded.
2. Increase the Frame Error Add Rate to 2 IN 4 and check that the Loss Of Frame (LOF) alarm indicator on the network element remains unlit and no occurrences of MS-RDI are recorded.
3. Increase the Frame Error Add Rate to 3 IN 4 and check that the Loss Of Frame (LOF) alarm indicator on the network element remains unlit and no occurrences of MS-RDI are recorded.
4. Increase the Frame Error Add Rate to 4 IN 4 and check that the OOF and LOF alarm indicators on the network equipment are lit and occurrences of MS-RDI are recorded.
5. Decrease the Frame Error Add Rate to 3 IN 4 and check that the OOF and LOF alarm indicators on the network equipment remain lit and occurrences of MS-RDI are still being recorded.
6. Decrease the Frame Error Add Rate to 2 IN 4 and check that the OOF and LOF alarm indicators on the network equipment go off, and no further occurrences of MS-RDI are recorded.

#### Sequence Generation Test Function

1. Connect the HP 37717C to the network equipment and set up the **OTHER** **SETTINGS CONTROL** display as shown opposite.

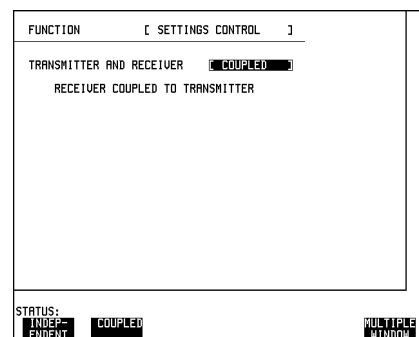

## SDH Testing Frame Synchronization

2. Set up the **TRANSMIT**; **SDH** display as shown opposite.

The **CLOCK SYNC** selection determines the synchronization source for the **TRANSMIT** clock. If **EXTERNAL MTS** is selected a 2 Mb/s reference must be connected to the front panel 2M REF IN port. The format can be **CLOCK** or **DATA**.

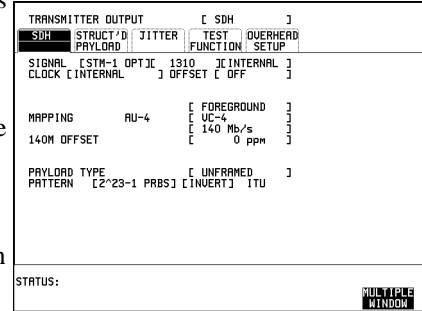

3. Set up the **RESULTS** display as shown opposite

**SHORT TERM PERIOD** need only be set if it is intended to view Short Term results.

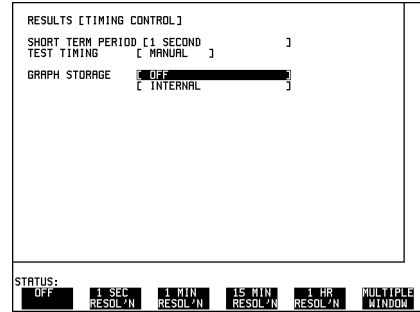

4..**ALARM SECONDS** are displayed but any of the other results can be selected from the softkey menu without affecting the measurement.

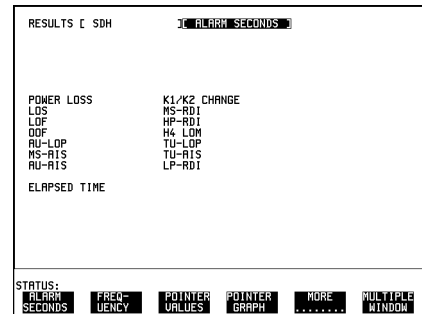

## SDH Testing

### Frame Synchronization

#### Start the Frame Synchronization Test (Sequence Test)

1. Set up the **TRANSMIT** TEST FUNCTION display as shown opposite.
2. Press **STARTED** on the **TRANSMIT** TEST FUNCTION display to start the sequence. As a result of this sequence one OOF alarm second and one LOF alarm second should occur every two seconds.
3. Check that the network element OOF and LOF alarm indicators cycle ON and OFF and that an occurrence of MS-RDI is recorded every two seconds.
3. Press **STOPPED** to stop the sequence and set up the **TRANSMIT** TEST FUNCTION display as shown opposite.
4. Press **STARTED** on the **TRANSMIT** TEST FUNCTION display to start the sequence. As a result of this sequence one OOF alarm second should occur every two seconds but LOF should not occur.
5. Check that the network element OOF alarm indicator cycles ON and OFF. The LOF alarm should not occur and no occurrences of MS-RDI should be recorded.

```

TRANSMITTER OUTPUT [ SDH ]
SDH STRUCT ID JITTER TEST OVERHEAD
PAYLOAD FUNCTION SETUP
TEST FUNCTION [ SDH ] SEQUENCES ]
[ REPEAT RUN ] [ STOPPED ] -SEQUENCE STOPPED
OVERHEAD CHANNEL [ RSDH ] [ 3xH1, 3xH2 ]
A [ F8F8F8282828 ]
B [ 090909D7D7D7 ]
C [ 000000000000 ]
D [ 000000000000 ]
E [ 000000000000 ]
SEQUENCE [ 15974 ] FRAMES OF [ A ] THEN
[ 26 ] [ 00 ]
[ 0 ] [ 0 ]
[ 0 ] [ 0 ]
[ 0 ] [ 0 ]
STATUS:
A B C D E MULTIPLE WINDOW

```

```

TRANSMITTER OUTPUT [ SDH ]
SDH STRUCT ID JITTER TEST OVERHEAD
PAYLOAD FUNCTION SETUP
TEST FUNCTION [ SDH ] SEQUENCES ]
[ REPEAT RUN ] [ STOPPED ] -SEQUENCE STOPPED
OVERHEAD CHANNEL [ RSDH ] [ 3xH1, 3xH2 ]
A [ F8F8F8282828 ]
B [ 090909D7D7D7 ]
C [ 000000000000 ]
D [ 000000000000 ]
E [ 000000000000 ]
SEQUENCE [ 15974 ] FRAMES OF [ A ] THEN
[ 24 ] [ 00 ]
[ 0 ] [ 0 ]
[ 0 ] [ 0 ]
[ 0 ] [ 0 ]
STATUS:
A B C D E MULTIPLE WINDOW

```

## SDH Jitter Transfer

Digital transmission systems use Regenerators to transport the signal over long distances. These Regenerators are cascaded together and it is important that each regenerator adds minimal amounts of jitter to the signal.

It is necessary during installation and maintenance to measure the degree to which jitter present at the input is amplified or attenuated by the network elements (Jitter Gain/Transfer).

The jitter transfer measurement entails measuring the input and output jitter at selected jitter frequencies within the jitter bandwidth. The jitter gain is calculated :  
Jitter Gain (dB) = 20 Log {Jitter<sub>out</sub> / Jitter<sub>in</sub>}

When the network equipment meets CCITT specification G.823 it should be possible to connect network elements without incurring bit errors.

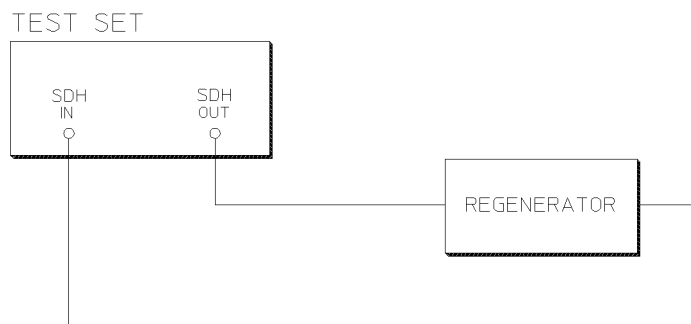

### Default (Known State) Settings

It can be advisable to set the HP 37717C to a known state prior to setting up to make a measurement. This clears all previous settings and provides a clearly defined instrument state. The default settings are set by selecting **OTHER** **STORED** **SETTINGS** STORED SETTING NUMBER 0 and pressing **RECALL**.

### Test Setup Procedure (Jitter Transfer Test)

The following Options must be fitted to the HP 37717C to perform this test :

- A3K - Jitter and Wander Generation

## SDH Testing

### SDH Jitter Transfer

- A3V or A3N- SDH Jitter Measurement
- A3R [A3S] - SDH Module

This setup procedure is based on 155.52 Mb/s (STM-1), 140 Mb/s payload, PRBS test data with jitter. The Jitter frequency is varied within the jitter bandwidth and the received jitter is measured to allow calculation of the jitter gain.

1. Set up the OTHER SETTINGS CONTROL display as shown opposite.

Any SDH settings change made on the **TRANSMIT** or **RECEIVE** displays will automatically occur on the other.

FUNCTION [ SETTINGS CONTROL ]	
TRANSMITTER AND RECEIVER <b>COUPLED</b>	
RECEIVER COUPLED TO TRANSMITTER	
STATUS:	
INDEPENDENT	<b>COUPLED</b>
MULTIPLE WINDOW	

2. Connect the HP 37717C to the line equipment, select **TRANSMIT**; **SDH** and set up the display as shown opposite.

TRANSMITTER OUTPUT [ SDH ]	
<b>SDH</b>	STRUCT'D [ ]
PAYLOAD [ ]	JITTER [ ]
	TEST [ ] OVERHEAD [ ]
	FUNCTION [ ] SETUP [ ]
SIGNAL [ STM-1 ]	CLOCK [ INTERNAL ]
	OFFSET [ OFF ]
MAPPING AU-4	[ FOREGROUND ]
	[ UC-4 ]
140M OFFSET	[ 140 Mb/s ]
	[ 0 ppm ]
PAYLOAD TYPE	[ UNFRAMED ]
PATTERN [ 2 <sup>23</sup> -1 PRBS ]	[ INVERT ] ITU [ ]
STATUS:	
MULTIPLE WINDOW	

3. Select **TRANSMIT**; JITTER and set up the display as shown opposite.

Select the required Jitter MODULATING FREQUENCY and AMPLITUDE.

TRANSMITTER OUTPUT [ SDH ]	
<b>SDH</b>	STRUCT'D [ ]
PAYLOAD [ ]	<b>JITTER</b> [ ]
	TEST [ ] OVERHEAD [ ]
	FUNCTION [ ] SETUP [ ]
JITTER / WANDER	[ JITTER ]
JITTER	[ ON ]
SIGNAL FREQUENCY	[ STM-1 ]
MODULATION SOURCE	[ INTERNAL ]
JITTER MASK	[ OFF ]
CLOCK SYNC	INTERNAL
RANGE	[ 1.0 UI ]
MODULATION FREQUENCY	[ 1000 Hz ]
AMPLITUDE	[ 1.00 UI ]
STATUS:	
MULTIPLE WINDOW	

## SDH Testing SDH Jitter Transfer

4. Setup the **RECEIVE**; **SDH JITTER** display as shown opposite.

If Jitter filtering is required select from the softkey menu.

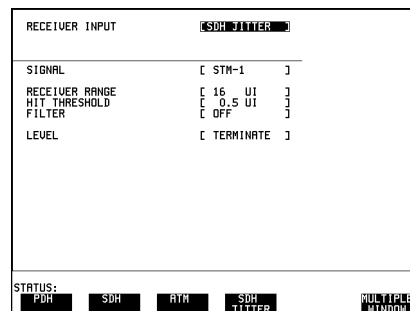

### Run the Test (Jitter Transfer)

1. Select **RESULTS** and set up the display as shown opposite.

SHORT TERM PERIOD need only be set if it is intended to view Short Term results.

2. Press **RUN/STOP** to start the measurement.

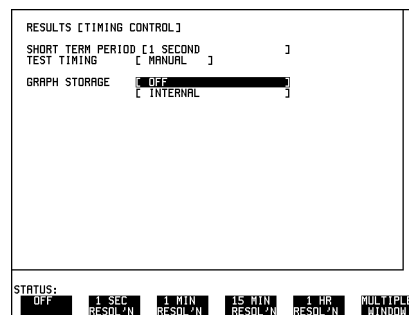

3. Record the Jitter Amplitude result from the **RESULTS** display.

4. Select each jitter Modulating Frequency and Amplitude in turn on the **TRANSMIT** display, press **RUN/STOP** twice and record the Jitter Amplitude result from the **RESULTS** display.

5. Calculate the Jitter gain for each frequency selected.

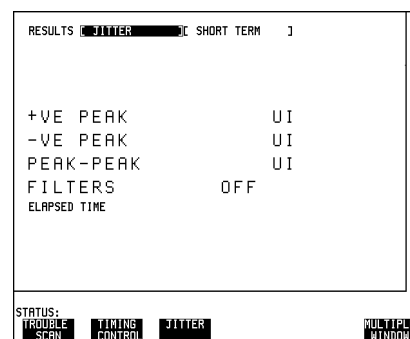

Jitter Gain (dB) = 20 Log {Jitter out / Jitter in}. Where Jitter In is the AMPLITUDE selected on the **TRANSMIT** display.

## **MSP Stimulus/Response**

### **Application**

Multiplexer Section Protection (MSP) is an optional feature for SDH Multiplexer Section Terminating Equipment (MSTE). For those MSTE's, in which it is provided, the MSP system is standardized to ensure the interworking of MSP between MSTE's from different suppliers.

Standard messages, carried in the K1 and K2 bytes of the SDH signal transport overhead, indicate the state of the MSP.

Switching to the protection line occurs when one of the following conditions exists for a specified length of time :

- Loss Of Signal (LOS)
- Loss Of Frame (LOF)
- Signal Fail - Bit Error Ratio  $> 1 \times 10^{-3}$
- Signal Degrade - Bit Error Ratio programmable
- MS-AIS

The Signal Degrade Bit Error Ratio threshold is normally programmable in the range  $1 \times 10^{-5}$  to  $1 \times 10^{-9}$ .

The HP 37717C Communications Performance Analyzer can be used to test Multiplexer Section Protection switching by :

Generating the switching conditions listed above.

Transmitting and monitoring the K1 K2 messages.

### **MSP Stimulus/Response 1+1 Architecture Test Setup Procedure**

In this setup the HP 37717C PDH/SDH test set, inserted in the working line, generates B2 BIP errors in sufficient quantity to violate the Signal Degrade threshold of the Multiplexer Section Protection. The network equipment Service Terminal indicates that switching to the standby line has occurred. The activity on the K1 K2 bytes can be monitored on the TRANSMIT TEST FUNCTION MSP Messages display.

SDH Testing  
**MSP Stimulus/Response**

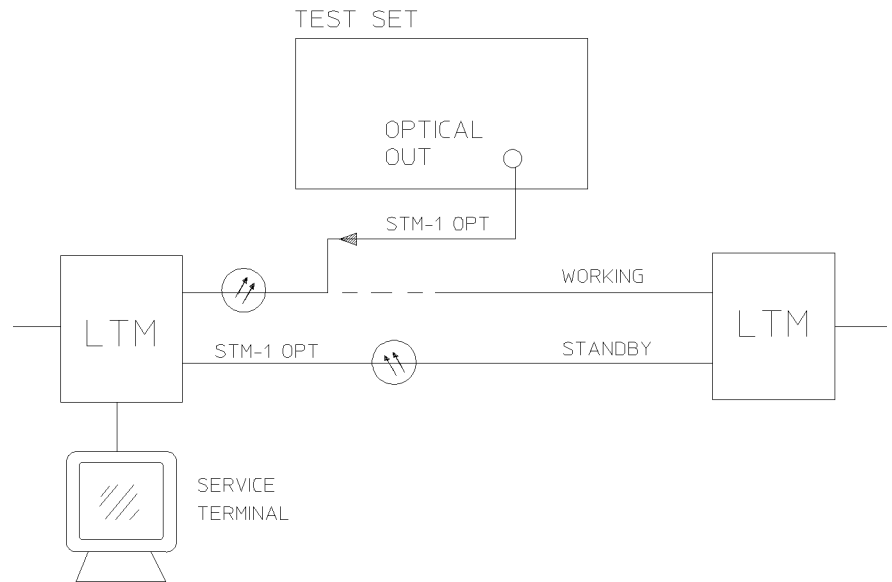

1. Set up the **TRANSMIT**; **SDH** display as shown opposite.

The **CLOCK SYNC** selection determines the synchronization source for the **TRANSMIT** clock. If **EXTERNAL MTS** is selected a 2 Mb/s reference must be connected to the front panel 2M REF IN port. The format can be **CLOCK** or **DATA**.

TRANSMITTER OUTPUT		[ SDH ]
<b>SDH</b>	STRUCT'D	JITTER
PHYLORD	TEST FUNCTION	OVERHEAD SETUP
SIGNAL [STM-1 OPT]C	1310	[ INTERNAL ]
CLOCK [INTERNAL]	OFFSET [ OFF ]	
MAPPING	AU-4	[ FOREGROUND ]
		[ VC-4 ]
140M OFFSET		[ 140 Mb/s ]
		[ 0 ppm ]
PHYLORD TYPE		[ UNFRAMED ]
PATTERN	[ 2^23-1 PRBS ]	[ INVERT ]
		[ ITU ]
STATUS:		<b>MULTIPLE WINDOW</b>



## SDH Testing MSP Stimulus/Response

2. Set up the **TRANSMIT**; TEST FUNCTION display as shown opposite.

1530 B2 BIP errors in 1 second corresponds to a BER of 1 in  $10^{-5}$ . The Service terminal should indicate switching to standby within 1 second.

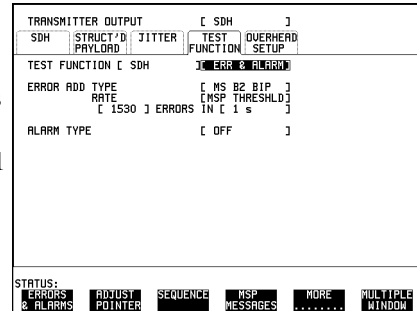

### MSP Stimulus/Response 1:N Architecture

The HP 37717C Communications Performance Analyzer **TRANSMIT**;TEST FUNCTION ; **MSP MESSAGES** can be used to transmit and monitor the K1 K2 messages.

The MSP Messages are transmitted when **DOWNLOAD** is pressed.

Two displays of K1 and K2 are provided :

1. **Current TX** - Values of K1 and K2 bytes which are currently being transmitted.

2. **Current RX** - Values of K1 and K2 bytes which are currently being received.

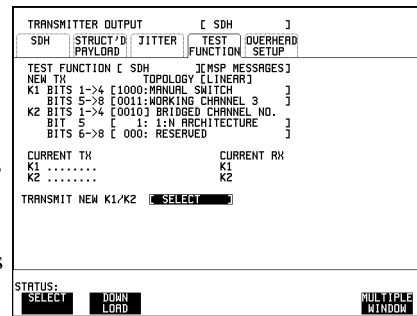

**K1 Bits 1 ->4** Selects the MSP message to be transmitted.

Table 1

**K1 Bits 1 - >4**

Selection	Message	Selection	Message
0000	NO REQUEST	1000	MANUAL SWITCH
0001	DO NOT REVERT	1001	NOT USED
0010	REVERSE REQUEST	1010	SD - Low Priority
0011	NOT USED	1011	SD - High Priority

SDH Testing  
**MSP Stimulus/Response**

**Table 1**

**K1 Bits 1 - >4**

Selection	Message	Selection	Message
0100	EXERCISE	1100	SF - Low Priority
0101	NOT USED	1101	SF - High Priority
0110	WAIT TO RESTORE	1110	FORCED SWITCH
0111	NOT USED	1111	LOCKOUT OF PROT

SD - High Priority and SF - High Priority are only available when K2 bit 5 is set to 1 (1 : N architecture).

**K1 Bits 5 ->8** Selects the channel used by the MSP Messages.

**Table 2**

**K1 Bits 5 - >8**

Selection	Message	Selection	Message
0000	NULL CHANNEL	1000	WORKING CHANNEL #8
0001	WORKING CHANNEL #1	1001	WORKING CHANNEL #9
0010	WORKING CHANNEL #2	1010	WORKING CHANNEL #10
0011	WORKING CHANNEL #3	1011	WORKING CHANNEL #11
0100	WORKING CHANNEL #4	1100	WORKING CHANNEL #12
0101	WORKING CHANNEL #5	1101	WORKING CHANNEL #13
0110	WORKING CHANNEL #6	1110	WORKING CHANNEL #14
0111	WORKING CHANNEL #7	1111	EXTRA TRAFFIC CHANNEL

WORKING CHANNEL #2 through WORKING CHANNEL #14 and EXTRA TRAFFIC CHANNEL are only available when K2 Bit 5 is set to 1 : N architecture. If K1 bits 1 >4 are set to 1111 LOCKOUT OF PROT then K1 bits 5 ->8 are fixed at 0000 NULL CHANNEL.

**K2 bits 1 - >4** Selects the bridged channel used by the MSP Messages. Can be set in the range 0000 to 1111.

**K2 bit 5** Determines the automatic protection switch architecture.  
 0 (1 + 1 architecture), 1 (1 : N architecture)

## Optical Clock Recovery Stress

### Application

Ideally the clock recovery circuits in the network equipment optical interfaces should recover a clock even in the presence of long strings of 0's.

The optical clock recovery performance of the network equipment can be measured by increasing the length of a zero substitution block until errors occur.

### Default (Known State) Settings

It is advisable to set the HP 37717C to a known state before setting up a measurement. This clears all previous settings and provides a clearly defined instrument state. The default settings are set by selecting **OTHER STORED SETTINGS** STORED SETTING NUMBER 0 and pressing **RECALL**

### Optical Clock Recovery Stress Test Setup Procedure

In this setup procedure the HP 37717C Communications Performance Analyzer transmits an STM-1 optical signal with zero's substituted into the payload data pattern. The length of the block of zero's is increased until the network equipment alarms are triggered.

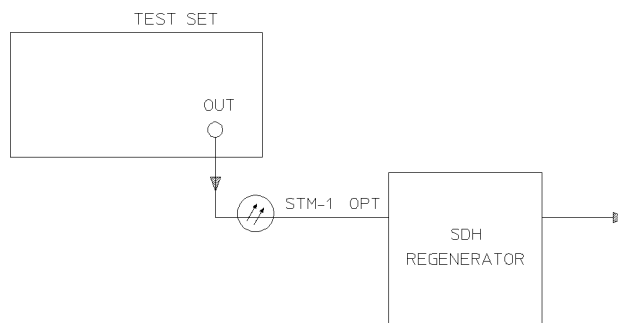

## SDH Testing Optical Clock Recovery Stress

1. Connect the HP 37717C to the network equipment and set up the **TRANSMIT**; **SDH** display as shown opposite.

The **CLOCK SYNC** selection determines the synchronization source for the **TRANSMIT** clock. If **EXTERNAL MTS** is selected a 2 Mb/s reference must be connected to the front panel 2M REF IN port. The format can be **CLOCK** or **DATA**.

TRANSMITTER OUTPUT		[ SDH ]
<b>SDH</b>	STRUCT'D	JITTER
PAYLOAD	TEST	OVERHEAD
	FUNCTION	SETUP
SIGNAL	[ STM-1 OPT ]	[ 1310 ]
CLOCK	[ EXT MTS CLK ]	[ OFF ]
		[ INTERNAL ]
MAPPING	AU-4	[ FOREGROUND ]
		[ UC-4 ]
140M OFFSET		[ 140 Mb/s ]
		[ 0 ppm ]
PAYLOAD TYPE		[ UNFRAMED ]
PATTERN	[ 2 <sup>n</sup> -15-1 PRBS ]	[ INVERT ]
		[ ITU ]
STATUS:		<b>MULTIPLE WINDOW</b>

2. Set up the **TRANSMIT**; **TEST FUNCTION** display as shown opposite

G.958 Test Pattern consists of consecutive blocks of four types of data :

All 1's

PRBS

All 0's

a data block consisting of the first row of section overhead bytes.

TRANSMITTER OUTPUT		[ SDH ]
<b>SDH</b>	STRUCT'D	JITTER
PAYLOAD	<b>TEST</b>	OVERHEAD
	FUNCTION	SETUP
TEST FUNCTION	[ SDH ]	[ STRESS TEST ]
STRESSING PATTERN		[ ALL ZEROS ]
BLOCK LENGTH		[ 2 ] BYTES
STATUS:		<b>MULTIPLE WINDOW</b>

### Start the Optical Clock Recovery Stress Test

Increase the Block Length until the network equipment alarms are triggered.

---

## **Payload Mapping/Demapping**

### **Application**

The mapping and demapping of a 2 Mb/s or 140 Mb/s payload into/from the appropriate SDH containers should take place without introducing errors.

The mapping process is tested by inserting a test pattern in the 2 Mb/s or 140 Mb/s payload at the low-rate side of the terminal multiplexer. On the high-rate side of the terminal multiplexer, the payload is demapped from the SDH signal by the HP 37717C Communications Performance Analyzer.

The demapping process is tested by transmitting a SDH signal to the high-rate side of the multiplexer. On the low-rate side of the multiplexer the payload is received by the HP 37717C Communications Performance Analyzer.

A Bit error rate (BER) test is performed on the recovered payload test pattern to determine whether errors have been introduced by the mapping process.

### **Default (Known State) Settings**

It is advisable to set the HP 37717C to a known state before setting up a measurement. This clears all previous settings and provides a clearly defined instrument state. The default settings are set by selecting **OTHER STORED SETTINGS** STORED SETTING NUMBER 0 and pressing **RECALL**.

### **Payload Mapping/Demapping Test Setup Procedure**

The following Options must be fitted to the HP 37717C to perform this test :

- UKJ or UKK - PDH Module
- A3R [A3S] - SDH Module
- UH1, 130 or 131 - STM-1/STM-4 Optical Interface

For mapping a 140 Mb/s payload, containing a test pattern, is transmitted into the low-rate side of the terminal multiplexer. The 140 Mb/s payload is demapped from the STM-4 Optical signal at the high-rate side of the terminal multiplexer.

For demapping an STM-4 Optical signal is transmitted into the high-rate side of the Add Drop multiplexer. The 140 Mb/s signal, on the low-rate side of the Add Drop multiplexer, is received by the HP 37717C Communications Performance Analyzer.

A BER measurement is performed on the demapped 140 Mb/s payload test pattern.

**SDH Testing**  
**Payload Mapping/Demapping**

A SINGLE test period of 24 HOURS is used and the internal printer is enabled to record results and alarms.

The HP 37717C Communications Performance Analyzer GRAPHICS function is enabled. The graphical results can be viewed on the GRAPH display

**Payload Mapping**

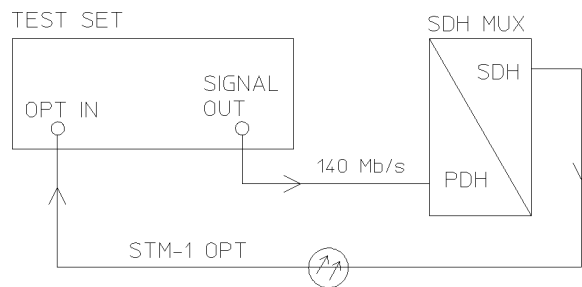

**Payload Demapping**

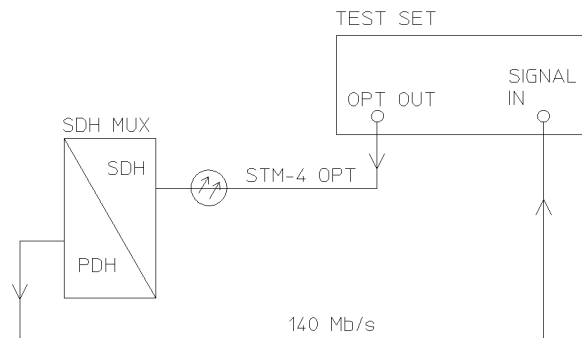

## SDH Testing Payload Mapping/Demapping

1. Connect the HP 37717C to the network equipment and set up the **OTHER** **SETTINGS CONTROL** display as shown opposite.

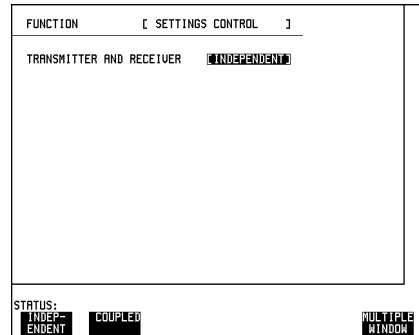

2. For Mapping set up the **TRANSMIT** display as shown opposite.

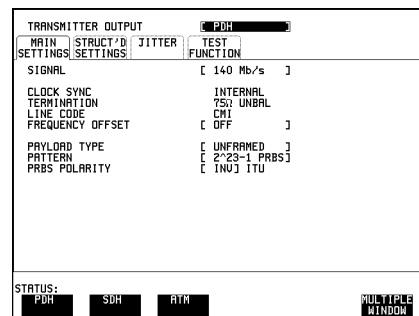

2a. For Demapping set up the **TRANSMIT** display as shown opposite.

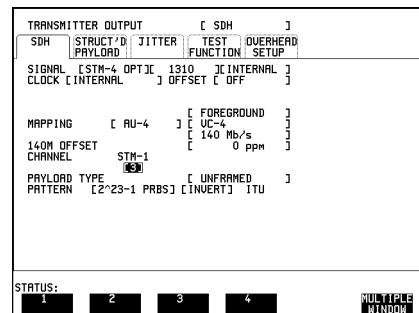

## SDH Testing Payload Mapping/Demapping

3. For Mapping set up the **RECEIVE** display as shown opposite.

RECEIVER INPUT	[ SDH ]
<b>SDH</b> STRUCT'D TEST OVERHEAD	
PAYLOAD FUNCTION MONITOR	
SIGNAL	[ STM-1 OPT ]
MAPPING	AU-4 [ UC-4 ] [ 140 Mb/s ]
PAYLOAD TYPE	[ UNFRAMED ]
PATTERN	[ 2^23-1 PRBS ] [ INVERT ] [ ITU ]
STATUS:	
	<b>MULTIPLE WINDOW</b>

3a. For Demapping set up the **RECEIVE** display as shown opposite.

RECEIVER INPUT	[ PDH ]
<b>MAIN</b> STRUCT'D JITTER	
SETTINGS SETTINGS	
SIGNAL	[ 140 Mb/s ]
TERMINATION	[ 75Ω UNBAL ]
LINE CODE	[ CMI ]
LEVEL	[ TERMINATE ]
PAYLOAD TYPE	[ UNFRAMED ]
PATTERN	[ 2^23-1 PRBS ]
PRBS POLARITY	[ INU ] [ ITU ]
STATUS:	
	<b>MULTIPLE WINDOW</b>

4. Set up the **OTHER** display, **LOGGING** function, as shown opposite.

All results are logged to the selected logging device at 1 hour intervals. Any alarms which occur during the test period will be logged To the selected logging device.

FUNCTION	[ LOGGING ]
LOGGING SETUP	[ CONTROL ]
LOGGING PERIOD	[ ON ] [ 1 HOUR ]
RESULTS LOGGED	[ SELECTED ]
WHEN	[ PERIOD ] [ 0 ]
CONTENT	[ ER & ANAL ] [ PER & CUMUL ]
LOG ERROR SECONDS	[ OFF ]
LOG AT END OF TEST	[ ALL RESULTS ]
LOG ON DEMAND	RESULTS
STATUS:	
<b>FAILAYS</b>	PERIOD EC > 0
	<b>MULTIPLE WINDOW</b>



## SDH Testing Payload Mapping/Demapping

### Start the Payload Mapping/Demapping Test

1. Set up the **RESULTS** display as shown opposite. If you do not require stored graphics results select **STORAGE [OFF]**.

**SHORT TERM PERIOD** need only be set if it is intended to view Short Term results.

2. Press **RUN/STOP** to start the measurement.

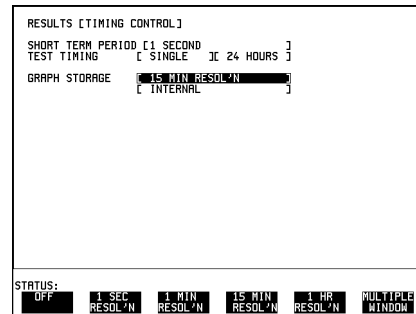

The measurement results and alarms are available on the **RESULTS** display during the test period.

The graphical measurement results and alarms are stored in non volatile memory for viewing later on the **GRAPH** display.

The test can be halted at any time by pressing **RUN/STOP** .

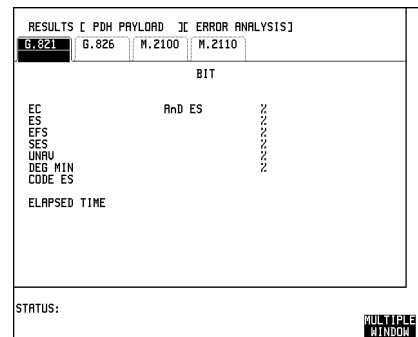

## SDH Testing

### Payload Mapping/Demapping

#### At the End of the Test (Payload Mapping/Demapping)

- The Date and Time the test started and the instrument setup are logged to the selected logging device.
- All results are logged to the selected logging device at 1 hour intervals.
- Any alarms which occur during the test period will be logged to the selected logging device.
- At the end of the test period a complete set of cumulative results are logged to the selected logging device.
- A graphical record of the results during the test period can be viewed on the GRAPH display. If a printer option is fitted the graph results can be logged to a printer, at a later date.
- Results and Alarm summaries can be viewed on the **GRAPH** display.

The total graphics store capacity is normally 20,000 events. An event is the occurrence of an error or an alarm.

The resolution, determined by the selection made under STORAGE on the **RESULTS** display, affects the ZOOM capability when viewing the bar graphs. If 1 SECOND is selected all resolutions are available under ZOOM. If 1 MIN is selected only 1 MIN/BAR, 15 MINS/BAR and 60 MINS/BAR are available. If 15 MINS is selected only 15 MINS/BAR and 60 MINS/BAR are available. If 1 HOUR is selected only 60 MINS/BAR is available.

Up to 10 sets of graphical results can be stored. If an attempt is made to store more than 10 sets of results, then a first in first out policy is operated and the oldest set of results will be lost. If graphics are enabled and a test is run which exceeds the remaining storage capacity, then some previously stored graphical results will be lost.

To prevent accidental overwriting of previously stored results the graphics capability should be disabled, when graphical results are not required, by selecting STORAGE [OFF] on the **RESULTS** display.

---

## **Performance Monitor Stimulus / Response**

### **Application**

Performance monitors built into the SDH network equipment count BIP errors, and communicate the results to the network controller via the Data Communication Channel (DCC). Performance monitors in Path Terminating Equipment (PTE) also communicate with the upstream equipment.

If the performance monitors are not operating correctly, degradations in network performance will pass unnoticed and may result in a failure condition.

The performance monitors can be tested by the Communications Performance Analyzer transmitting BIP errors in the appropriate byte of the overhead and monitoring upstream for the correct response :

Regenerator Section (RS) - B1 Byte of regenerator section overhead

Multiplexer Section (MS) - B2 Bytes of multiplexer section overhead

PATH B3 - B3 Byte of path overhead

### **Default (Known State) Settings**

It is advisable to set the HP 37717C to a known state before setting up a measurement. This clears all previous settings and provides a clearly defined instrument state. The default settings are set by selecting **OTHER STORED SETTINGS** STORED SETTING NUMBER 0 and pressing **RECALL**

### **Performance Monitor Stimulus/Response Test Setup Procedure**

The following Options must be fitted to the HP 37717C to perform this test :

- A3R - SDH Module
- UH1,130 or 131 - STM-1/STM-4 Optical Interface

In this setup the HP 37717C Communications Performance Analyzer inserts "PATH" B3 BIP errors in byte B3 of the path overhead of the SDH signal. The upstream signal is monitored to provide a measure of the FEBE (Far End Block Error) count.

## SDH Testing Performance Monitor Stimulus / Response

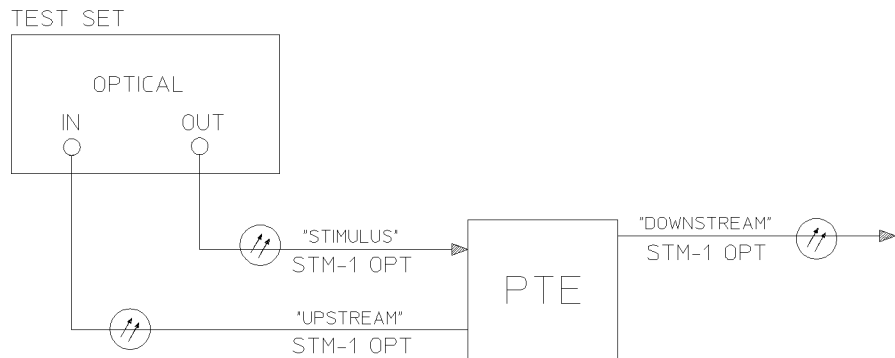

1. Connect the HP 37717C to the network equipment and set up the **OTHER**; **SETTINGS CONTROL** display as shown opposite.

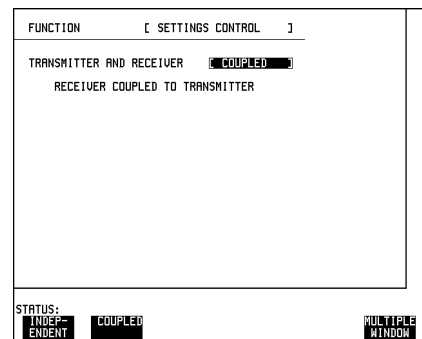

2. Set up the **TRANSMIT**; **SDH** display as shown opposite.

The **CLOCK SYNC** selection determines the synchronization source for the **TRANSMIT** clock.

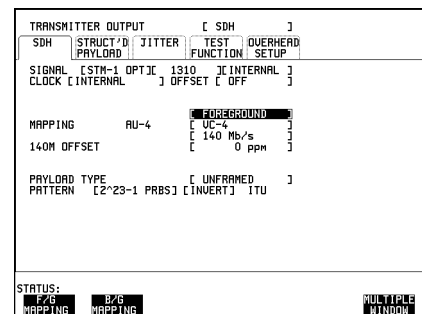

## SDH Testing

### Performance Monitor Stimulus / Response

3. Set up the **RESULTS** display as shown opposite.

SHORT TERM PERIOD need only be set if it is intended to view Short Term results

```
RESULTS [TIMING CONTROL]
SHORT TERM PERIOD [1 SECOND ]
TEST TIMING [MANUAL ]
GRAPH STORAGE [OFF ]
               [INTERNAL ]

STATUS:
OFF 1 SEC RESOL'N 1 MIN RESOL'N 15 MIN RESOL'N 1 HR RESOL'N MULTIPLE WINDOW
```

HP-REI ERROR RESULTS are displayed but any of the other results can be selected from the softkey menu without affecting the measurement.

```
RESULTS [SDH] IC CUMULATIVE ]
PATH B3 PATH B2 PATH B1 PATH IE MORE
BIP BEC BEC IE

FEBC EC
FEBC ER

ELAPSED TIME

STATUS: MULTIPLE WINDOW
```

4. Set up the **TRANSMIT**; TEST FUNCTION display as shown opposite.

The ERROR RATE required can be selected from the softkey menu.

```
TRANSMITTER OUTPUT [SDH]
SDH STRUCT'D PAYLOAD JITTER TEST FUNCTION OVERHEAD SETUP
TEST FUNCTION [SDH] IC ERR & ALARM
ERROR ADD TYPE [B3 BIP]
RATE [1E-4]
ALARM TYPE [OFF ]

STATUS: MULTIPLE WINDOW
```

## SDH Testing

### Performance Monitor Stimulus / Response

#### Start the Performance Monitor Stimulus/Response Test

1. Press **RUN/STOP** on the HP 37717C Communications Performance Analyzer.
2. Check that the HP-REI error rate is the same as the generated B3 BIP rate.

All the measurement results are available, throughout the test, on the **RESULTS** display .

#### At the end of the test :

- the cumulative measurement results are available on the **RESULTS** display.

## Selective Jitter Transfer Measurement

The problem with many SDH jitter analyzers is the fact that their receivers are wideband receivers and are not able to measure within a sufficiently narrow bandwidth. The reason is that these instruments are designed to measure peak to peak jitter in the transmission network for troubleshooting purposes and are not designed to make selective jitter measurements. The jitter analyzer just measures the peak-peak value of the incoming jitter over a wide frequency range. The problem occurs when testing the jitter transfer of real network equipment i.e. SDH regenerators.

The regenerator produces intrinsic jitter and this disturbs the measurement as the jitter receiver cannot determine whether it is measuring the jitter produced by the jitter analyzers transmitter or the intrinsic jitter which is generated, at a different frequency, by the regenerator. The problem is greatest at the higher jitter modulating frequencies when the amount of jitter generated, as per ITU-T G.958, is much smaller. The measurement is corrupted by the higher amplitude intrinsic jitter generated by the regenerator at lower frequencies and incorrectly measured by the analyzer.

The accurate method for measuring jitter transfer requires a selective measurement. One such method is to use a network analyzer in conjunction with the HP 37717C. The network analyzer provides the capability to measure jitter selectively and has increased sensitivity.

### Default (Known State) Settings

It can be advisable to set the HP 37717C to a known state prior to setting up to make a measurement. This clears all previous settings and provides a clearly defined instrument state. The default settings are set by selecting **OTHER STORED SETTINGS** STORED SETTING NUMBER 0 and pressing **RECALL**

### Test Setup Procedure (Jitter Transfer Test)

The following Options must be fitted to the HP 37717C to perform this test:

- A3K - Jitter Generation
- A3L or A3V or A3N - SDH Jitter Measurement
- A3R [A3S] - SDH Module
- UH1, 130 or 131 - STM-1/4 Optical interface

## SDH Testing

### Selective Jitter Transfer Measurement

This setup procedure is based on 155.52 Mb/s (STM-1), 140 Mb/s payload, PRBS test data with jitter. The jitter modulation is provided by the network analyzer. The HP 37717C demodulated jitter output is returned to the network analyzer for measurement. Before connecting to the regenerator to be tested the HP 37717C is looped back to back and the network analyzer is programmed to sweep over the required frequency range at the required amplitude. This provides a reference trace and removes the inaccuracies of the of the test configuration (inaccuracies of the HP 37717C and the Network Analyzer). The HP 37717C is connected to the regenerator and the network analyzer sweep is repeated. The difference between the two traces is the jitter transfer result.

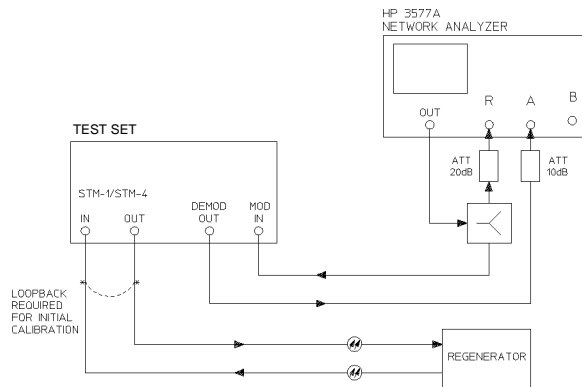

### Selective Jitter Transfer Test

1. Set up the OTHER SETTINGS CONTROL display as shown opposite.

Any SDH settings change made on the **TRANSMIT** or **RECEIVE** displays will automatically occur on the other.

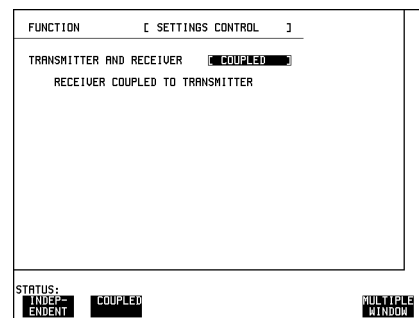



## SDH Testing

### Selective Jitter Transfer Measurement

2. Connect the HP 37717C to the network analyzer as shown. Connect STM-1/STM-4 IN to STM-1/STM-4 OUT. Select **TRANSMIT** **SDH** SDH and set up the display as shown opposite.

TRANSMITTER OUTPUT	[ SDH ]	
SDH STRUCT'D	JITTER	TEST OVERHEAD
PAYLOAD	FUNCTION	SETUP
SIGNAL	[ STM-4 OPT ]	1310 [ INTERNAL ]
CLOCK	[ EXT MTS CLK ]	[ OFFSET ] [ OFF ]
MAPPING	[ AU-4 ]	[ FOREGROUND ]
		[ UC-4 ]
140M OFFSET		[ 140 Mb/s ]
CHANNEL	STM-1	[ 0 ppm ]
	[ 1 ]	
PAYLOAD TYPE		[ UNFRAMED ]
PATTERN	[ 2 <sup>23</sup> -1 PRBS ]	[ INVERT ] ITU

STATUS: **SDH** **MULTIPLE WINDOW**

3. Select **TRANSMIT** **SDH** **JITTER** and set up the display as shown opposite.

TRANSMITTER OUTPUT	SDH	
SDH	JITTER	TEST OVERHEAD
FUNCTION	SETUP	
JITTER / WANDER	[ JITTER ]	
JITTER	[ ON ]	
SIGNAL FREQUENCY	STM-4	
MODULATION SOURCE	[ EXTERNAL ]	
RANGE	[ 2 UI ]	
CLOCK SYNC	EXT MTS	
CONNECT 2MHz SOURCE TO	SDH MODULE	

STATUS: **2 UI** **10 UI** **MULTIPLE WINDOW**

4. Setup the **RECEIVE** **SDH JITTER** display as shown opposite.

If Jitter filtering is required select from the softkey menu.

RECEIVER INPUT	[ SDH JITTER ]
SIGNAL	[ STM-4 OPT ]
RECEIVER RANGE	[ 1.6 UI ]
HIT THRESHOLD	[ 1.00 UI ]
FILTER	[ HPI ]
LEVEL	[ TERMINATE ]

STATUS: **SDH** **JITTER** **MULTIPLE WINDOW**

## SDH Testing

### Selective Jitter Transfer Measurement

5. Select **RESULTS** and set up the display as shown opposite.

Press **RUN/STOP** to start the measurement.

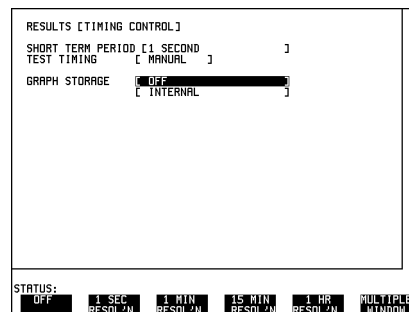

6. Adjust the network analyzer output level until the **RESULTS** display records the required peak-peak jitter value.

7. Press **RUN/STOP** to stop the measurement.

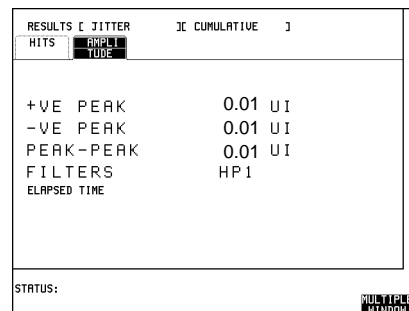

8. Start the network analyzer sweep and store the resultant "reference trace"

9. Connect the HP 37717C to the regenerator as shown (loopback removed) and repeat the network analyzer sweep.

The difference between the two traces is the Jitter Transfer result.

## **Automatic Alarm and BIP Error Monitoring**

### **Application**

Problems in the network at all levels in the hierarchy can be detected by the occurrence of alarms or BIP errors in each tributary of SDH systems. Since an STM-4 fibre contains up to 252 TU-12 tributaries, checking each tributary individually is time consuming and laborious.

Using the HP 37717C in a *receive only* mode, each tributary is scanned and any alarm or BIP occurrence is flagged on the **RESULTS** display. If the fibre contains an unknown signal structure (mixed payloads) the HP 37717C will quickly determine and scan that structure.

### **Default (Known State) Settings**

It can be advisable to set the HP 37717C to a known state prior to setting up to make a measurement. This clears all previous settings and provides a clearly defined instrument state. The default settings are set by selecting **OTHER** **STORED SETTINGS** STORED SETTING NUMBER 0 and pressing **RECALL**

### **Test Setup Procedure (Alarm Monitoring)**

The following Options must be fitted to the HP 37717C to perform this test:

- UKJ or UKK - PDH Module
- A3R [A3S] - SDH Module
- 130 or 131 - STM-1/4 Optical Interface

This setup procedure is based on STM-4 line traffic with mixed payload.

The instrument is used in a *receive only* mode to monitor Loss of Pointer, AU-AIS, HP-RDI, H4 Loss of Multiframe, TU-Loss Of Pointer, TU-AIS, LP-RDI alarms and BIP errors in AU-4, AU-3, TU-3, TU-2 and TU-12 payloads.

SDH Testing  
**Automatic Alarm and BIP Error Monitoring**

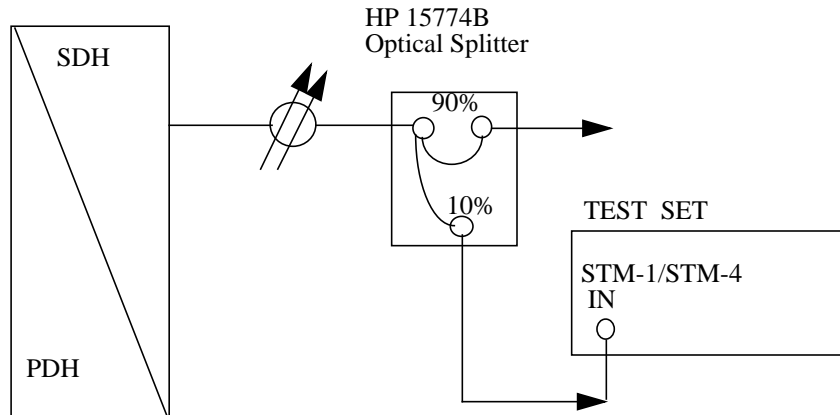

**Alarm Monitoring**

1. Connect the HP 37717C to the Network equipment via the optical splitter and set up the **RECEIVE SDH** display as shown opposite.

The MAPPING and TU PAYLOAD selections are only important if the Alarm Scan is to be carried out on the RX SETTINGS.

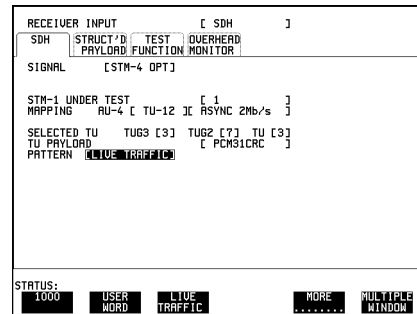

2. Set up the **RESULTS SDH ALM SCAN** display as shown opposite.

**AUTO** configures the HP 37717C to determine the received payload structure and carry out an Alarm Scan in each tributary.

BIP [>0] configures the 37717C to detect any occurrence of a BIP error. A choice of BIP [>1E-3] or [>1E-6] or [OFF] is also available.

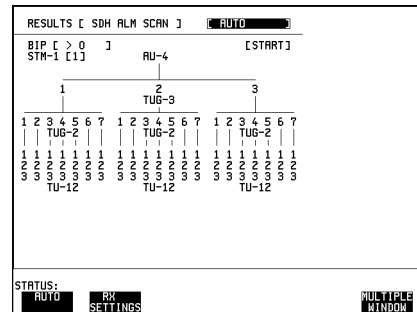

## SDH Testing

### Automatic Alarm and BIP Error Monitoring

#### Start the Test (Alarm Monitoring)

1. Select **START** on the **RESULTS SDH ALM SCAN** display.

If any of the alarms, Loss of Pointer, AU-AIS, HP-RDI, H4 Loss of Multiframe, TU Loss of Pointer, TU-AIS or LP-RDI has occurred the appropriate point in the hierarchy will be highlighted.

If a BIP error has occurred in the AU-4, AU-3, TU-3, TU-2 or TU-12 payload the appropriate point in the hierarchy will be highlighted.

If Unequiped is identified, the appropriate point in the hierarchy will be changed to U.

The test can be halted at any time by selecting **STOP** on the **RESULTS SDH ALM SCAN** display.

## **Automatic Verification of ADM Installation**

### **Application**

An important part of the ADM installation process is the verification of path routing through an ADM (or Digital Cross Connect). In order to verify the routing of VC-n paths which are terminated by the network element, the mapped payload, dropped to a PDH tributary port, must be looped back at the digital distribution frame and mapped into the VC-n at the PDH tributary insert port. VC-n paths which are not terminated must be looped back at the STM-n level. Since an STM-1 contains 63 VC-12's and a STM-4 contains 252 VC-12's, manually checking each path is time consuming and laborious.

Using the HP 37717C Tributary Scan feature the installation of ADM's can be automated and any Bit errors or Pattern Sync Loss will be flagged on the **RESULTS** display.

### **Default (Known State) Settings**

It can be advisable to set the HP 37717C to a known state prior to setting up to make a measurement. This clears all previous settings and provides a clearly defined instrument state. The default settings are set by selecting **OTHER** **STORED SETTINGS** STORED SETTING NUMBER 0 and pressing **RECALL**

### **Test Setup Procedure (Alarm Monitoring)**

The following Options must be fitted to the HP 37717C to perform this test:

- UKJ or UKK - PDH Module
- A3R [A3S]- SDH Module
- 130 or 131 - STM-1/4 Optical Interface

This setup procedure is based on STM-4 with 252 TU-12 payloads.

The instrument generates a STM-4 signal with 252 TU-12 tributaries. The tributaries are mapped into the STM-4 received signal and scanned by the Tributary Scan for bit errors and Pattern Sync Loss.

The Parallel printer port is enabled and the Tributary Scan results are logged to a Centronics printer

## SDH Testing

### Automatic Verification of ADM Installation

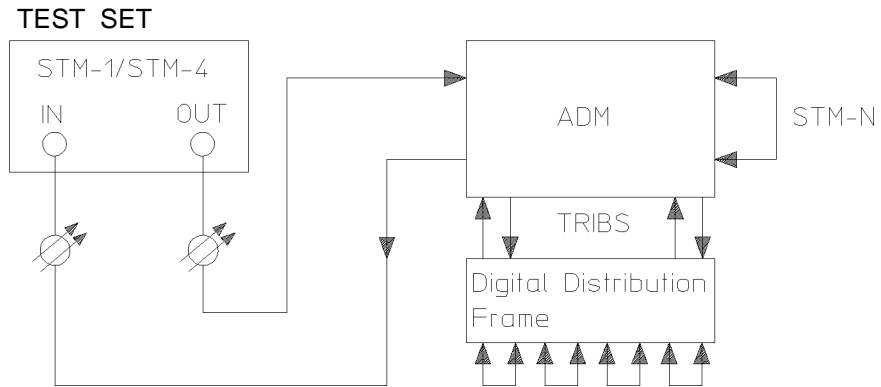

### ADM Installation

1. Connect the HP 37717C to the ADM and set up the **OTHER** display as shown opposite.

Any changes made on the **TRANSMIT** or **RECEIVE** display will affect the other.

2. Connect a Centronics printer to the HP 37717C Parallel printer port.

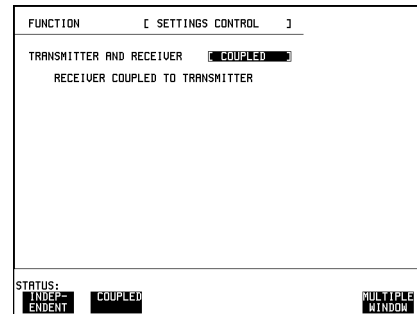

3. Set up the **TRANSMIT** **SDH** display as shown below.

The MAPPING and TU PAYLOAD selections should reflect the mapping and TU payload employed in the ADM

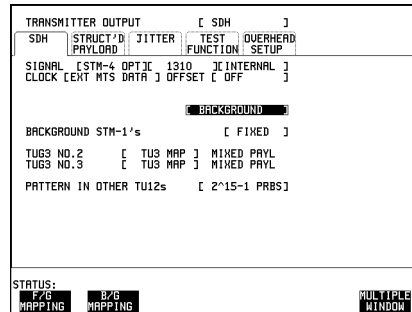
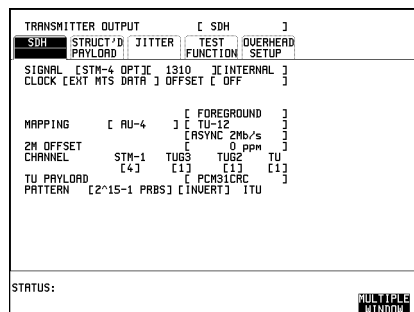

## SDH Testing

### Automatic Verification of ADM Installation

4. Set up the **TRANSMIT** TEST FUNCTION display as shown opposite.

The BIT ERROR THRESHOLD setting has three choices:

**> 0** - Any bit error will highlight the tributary in error.

**>1E-6** - Bit error rate greater than 1 in  $10^9$  will highlight the tributary in error.

**>1E-3** - Bit error rate greater than 1 in  $10^3$  will highlight the tributary in error.

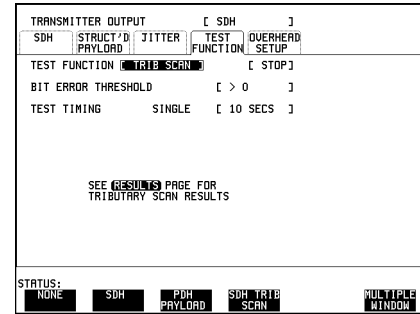

TEST TIMING determines the time taken to verify each tributary. If 10 seconds is selected, in this example 252 TU-12 tributaries, the test will take approximately 55 minutes.

#### Start the Test (ADM Installation)

1. Select **START** on the **RESULTS SDH TRIB SCAN** display.

The "flashing" message on the status line indicates that the SDH Tributary Scan is active.

For STM-4 signals only one STM-1 is displayed at a time. To view the other STM-1's select the required number 1, 2, 3 or 4 on the **RESULTS SDH TRIB SCAN** display.

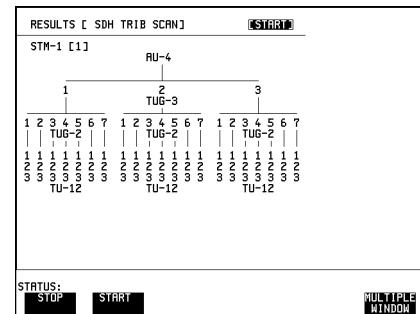

A PRBS is inserted in each tributary. If Pattern Synchronization is not achieved in 3 seconds the relevant tributary is highlighted. A Bit error measurement is performed in each tributary. The timing of the measurement is determined by the TEST TIMING selection made on the **TRANSMIT** TEST FUNCTION display, in this example 10 Seconds. If the Bit error rate exceeds the BIT ERROR THRESHOLD selected on the **TRANSMIT** TEST FUNCTION display the relevant tributary is highlighted.



## SDH Testing

### Automatic Verification of ADM Installation

2. Set up the **OTHER LOGGING** display as shown opposite.

PRINTER TYPE allows selection of HP printer or Alternative suppliers printer.

If [ALT. PRINTER] is selected a choice of **NORMAL** (80 column) or **COMPRESS** (40 column) is provided.

FUNCTION	[ LOGGING ]
LOGGING SETUP	[ DEVICE ]
LOGGING PORT	[ PARALLEL ]
REMOTE CONTROL PORT	HP1B
PRINTER TYPE	[ ALT. PRINTER ]
MODE	<b>NORMAL</b>

STATUS:  
**NORMAL** **COMPRESS** **MULTIPLE WINDOW**

3. Set up the **OTHER LOGGING** display as shown opposite.

LOG ON DEMAND [TRIB SCAN] ensures that the SDH Tributary Scan is logged to the Centronics printer when **PRINT NOW** is pressed.

At the end of the SDH Tributary Scan (the status line message is no longer "flashing") press **PRINT NOW** to log the results of all four STM-1's on the Centronics printer.

FUNCTION	[ LOGGING ]
LOGGING SETUP	[ CONTROL ]
LOGGING	[ OFF ]

LOG ON DEMAND **TRIB SCAN**

STATUS:  
**RESULTS** **OVERHEAD** **OVERHEAD** **PRINTER** **SDH TRIB** **MULTIPLE**  
**SNAPSHOT** **SNAPSHOT** **CAPTURE** **GRAPH** **SCAN** **WINDOW**

---

## **Verification of Protection Switching**

### **Application**

An important part of the installation process is the verification of protection switching mechanisms. Switching verification ensures that data integrity is maintained and revenue protected when equipment failure or fibre cuts occur. Measuring the speed of the network elements protection switch mechanism ensures data loss is minimized. The protection switch can be invoked by either removing the STM-n fibre or using the network management system to make the switch.

The protection switch times can then be measured using the HP 37717C's Service Disruption Time measurement. The measurement is made at the Path or Payload level carrying the actual service and therefore provides a real indication of the time the network takes to self heal.

Capability is also provided to invoke protection switching at the Multiplexer Section level using the K1K2 byte textual decodes otherwise known as MSP Message Generation. Both Linear Architecture MSP Messages as described in ITU-T G.783 and Ring Architecture MSPRing Messages as described in ITU-T G.841 are provided.

### **Default (Known State) Settings**

It can be advisable to set the HP 37717C to a known state prior to setting up to make a measurement. This clears all previous settings and provides a clearly defined instrument state. The default settings are set by selecting **OTHER** **STORED SETTINGS** STORED SETTING NUMBER 0 and pressing **RECALL**

### **Test Setup Procedure (Verification of Protection Switching)**

The following Options must be fitted to the HP 37717C to perform this test:

- UKJ or UKK - PDH Module
- A3R [A3S] - SDH Module
- 130 or 131 - STM-1/4 Optical Interface

This setup procedure is based on STM-1 with Structured PDH payload.

## SDH Testing

### Verification of Protection Switching

The instrument generates a STM-1 signal with a structured payload with PRBS pattern. This is inserted into the network element. The Receiver locks on to the PRBS pattern. The management system is used to invoke the protection switching. At the time of switching, pattern synchronization will be lost and will not be regained until the standby line is in place. The time interval between pattern sync loss and pattern sync gain is a measure of the disruption of service due to protection switching. This is measured by the HP 37717C.

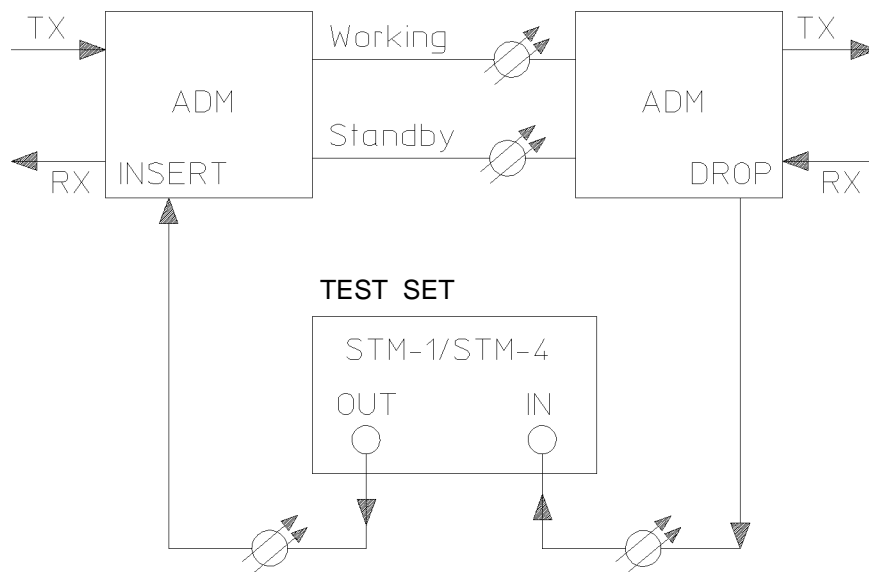

### Protection Switching Verification

## SDH Testing

### Verification of Protection Switching

1. Connect the HP 37717C to the ADM and set up the **OTHER** display as shown opposite.

Any changes made on the **TRANSMIT** or **RECEIVE** display will affect the other.

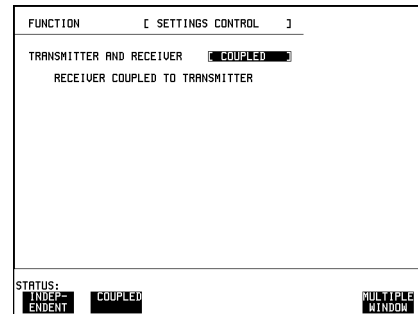

2. Set up the **TRANSMIT SDH** display as shown opposite.

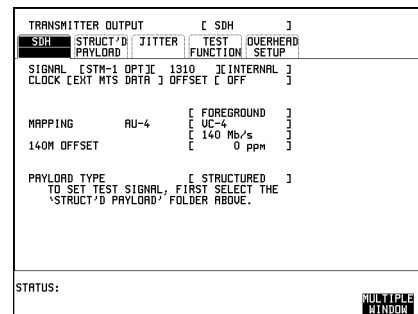

3. Set up the **TRANSMIT STRUCTURED PAYLOAD** display as shown opposite.

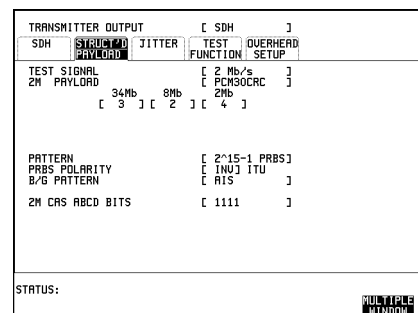

## SDH Testing

### Verification of Protection Switching

#### Start the Test (Protection Switch Verification)

Press **RUN/STOP** to start the test.

Check that pattern synchronization is achieved (no errors).

Invoke the protection switch using the network management system.

Set up the **RESULTS** display as shown opposite.

The Service Disruption result is displayed when pattern synchronization is regained.

**LONGEST** - Longest burst of errors during measurement.

**SHORTEST** - Shortest burst of errors during measurement.

**LAST** - Length of last burst of errors detected during measurement.

The screenshot shows a terminal window titled 'RESULTS' with a sub-header 'SRVC. DISRUPT'. The main content area displays the following metrics:

LONGEST	ms
SHORTEST	ms
LAST	ms
ELAPSED TIME	

At the bottom, there is a 'STATUS:' section with several indicators: PDH ALM. SCAN, SERVICE DISRUPT, SDH ALM. SCAN, SDH TRIB. SCAN, MORE ....., and MULTIPLE WINDOW.

---

## **Result Definitions**

Information about SDH results.

## Result Definitions

### Trouble Scan

---

## Trouble Scan

All possible error sources and alarms are scanned simultaneously. If any error counts are not zero then these are displayed. Up to 4 non-zero error counts are displayed in priority order

### Error Count Priority

UPDH (Option UKK[USB])	SDH (Option A3R [A3S])	SPDH (Option UKJ[USA])	ATM (Option UKN) + SDH	ATM (Option UKN) + SPDH
CRC BIT CODE FRAME REBE	RS B1 BIP or B1 BIP MS B2 BIP or B2 BIP Path B3 BIP or B3 BIP VC3 PATH BIP TU2 BIP TU12 BIP A1A2 FRAME MS FEBE or MS REI PATH FEBE or HP REI PATH IEC or HP IEC VC3 PATH FEBE or HP REI TU2 FEBE or LP REI TU12 FEBE or LP REI BIT	CRC BIT CODE FAS 140M FAS 34M FAS 8M FAS 2M REBE	<b>B1 BIP (SDH only)</b> <b>B2 BIP (SDH only)</b> <b>B3 BIP (SDH only)</b> <b>Non Corrected HEC</b> <b>Corrected HEC</b> <b>Lost Cells</b> <b>Misinserted Cells</b> <b>Path FEBE or REI</b> <b>Bit</b> <b>Errored Cells</b>	EM BIP Non Corrected HEC Corrected HEC Lost Cells Misinserted Cells EM FEBE Bit Errored Cells

If any alarms are active "ALARMS ACTIVE" is displayed.

**SHOW HISTORY** and the alarm led's can be used to determine which alarms are active.

If no alarms are active and no non-zero error counts are detected then "NO TROUBLE" is displayed.

---

## Error Summary

A summary of the short term / cumulative results as counts or ratios and optical power on one display.

## Result Definitions

### Short Term Results

---

## Short Term Results

Displays period results obtained during the measurement. The period is user-defined under SHORT TERM PERIOD on the **RESULTS** display. Many result parameters are presented in two forms: a count of error events (EC or COUNT) and a ratio of the number of errors to the total possible in the time period (ER or RATIO).

Error Count and Error Ratio results for the following error sources are available:

<b>A1A2 FRAME</b>	Compares the received Framing bytes with the known value. (Option A1T[A1U] only)
<b>B1 BIP</b>	Compares the received B1 with the recalculated value.
<b>B2 BIP</b>	Compares the received B2 with the recalculated value.
<b>MS-REI</b>	Calculated from the REI bits in the received M1 overhead byte. (Option A1T[A1U] only)
<b>B3 BIP</b>	Compares the received B3 with the recalculated value.
<b>HP-REI</b>	Calculated from the REI bits in the received G1 overhead byte.
<b>HP-IEC</b>	Calculated from the IEC bits in the received Z5 Path overhead byte. (Option A1T[A1U] only)

If a Payload of 34 Mb/s is selected, Error Count and Error Ratio results for the following additional error sources are also available:

<b>TU BIP</b>	Compares the received VC3, B3 with the recalculated value.
<b>LP-REI</b>	Calculated from the FEBE bits in the received VC3, G1 overhead byte.

If a Payload of 2 Mb/s is selected, Error Count and Error Ratio results for the following additional error sources are also available:

<b>TU BIP</b>	Compares the received V5, BIP-2 in the TU12 selected for test with the recalculated value.
<b>LP-REI</b>	Calculated from the FEBE bits in the V5 overhead byte of the TU12 selected for test.



## Result Definitions

### Cumulative Results

---

## Cumulative Results

Provides a cumulative display of the results during the measurement period. Many result parameters are presented in two forms: a count of error events (EC or COUNT) and a ratio of the number of errors to the total possible in the time period (ER or RATIO).

Error Count and Error Ratio results for the following error sources are available:

<b>A1A2 FRAME</b>	Compares the received Framing bytes with the known value. (Option A1T[A1U] only)
<b>B1 BIP</b>	Compares the received B1 with the recalculated value.
<b>B2 BIP</b>	Compares the received B2 with the recalculated value.
<b>MS-REI</b>	Calculated from the REI bits in the received M1 overhead byte. (Option A1T[A1U] only)
<b>B3 BIP</b>	Compares the received B3 with the recalculated value.
<b>HP-REI</b>	Calculated from the REI bits in the received G1 overhead byte.
<b>HP-IEC</b>	Calculated from the PIEC bits in the received Z5 Path overhead byte. (Option A1T[A1U] only)

If a Payload of 34 Mb/s is selected, Error Count and Error Ratio results for the following additional error sources are also available:

<b>TU BIP</b>	Compares the received VC3, B3 with the recalculated value.
<b>LP-REI</b>	Calculated from the FEBE bits in the received VC3, G1 overhead byte.

If a Payload of 2 Mb/s is selected, Error Count and Error Ratio results for the following additional error sources are also available:

<b>TU BIP</b>	Compares the received V5, BIP-2 in the TU12 selected for test with the recalculated value.
<b>LP-REI</b>	Calculated from the FEBE bits in the V5 overhead byte of the TU12 selected for test.

Result Definitions  
**SDH Error Analysis**

---

## SDH Error Analysis

Analysis results are calculated for the following error sources:

B1 BIP; B2 BIP; MS-REI; B3 BIP; HP-REI and HP-IEC. If a Payload of 34 Mb/s or 2 Mb/s is selected additional error sources of TU BIP and LP-REI are also available.

### G.826 Analysis B1 BIP

These calculations are based on "Errored Blocks". A Block is a set of consecutive bits associated with the Path. Each bit belongs to one and only one block. If an STM-4 interface is selected an errored block is a BIP with one or more bits in error.

Table 3-1

---

### G.826 Analysis B1 BIP

Display	Definition
ES	Errored Seconds - Cumulative count of 1 second periods that contain at least 1 Errored Block.
EB	Errored Block count - cumulative count of errored blocks.
SES	Severely errored Seconds - Cumulative count of 1 second periods with $\geq 2400$ Errored Blocks, or containing a "defect". Defects are LOS and LOF.
UNAV	Unavailability - Cumulative count of unavailable seconds. A period of unavailability begins at the start of 10 or more consecutive severely errored seconds, and ends at the start of 10 or more consecutive <b>non</b> severely errored seconds.
ESR	Error Second Ratio - The ratio of errored seconds to the total seconds of available time. A period of unavailability begins at the start of 10 or more consecutive Severely Errored Seconds, and ends at the start of 10 or more <b>non</b> Severely Errored Seconds.
SESR	Severely Errored Second Ratio - The ratio of severely errored seconds to the total seconds of available time.
BBEC	Background Block error count - Cumulative count of errored blocks which occur outwith a severely errored second.
BBER	Background Block error Ratio - The ratio of errored blocks to total blocks.Total blocks excludes severely errored seconds and periods of unavailability.

Result Definitions  
**SDH Error Analysis**

**G.826 Analysis B2 BIP**

These calculations are based on "Errored Blocks". A Block is a set of consecutive bits associated with the Path. Each bit belongs to one and only one block. If an STM-4 interface is selected an errored block is a BIP with one or more bits in error.

**Table 3-2**

**G.826 Analysis MS B2 BIP**

Display	Definition
ES	Errored Seconds - Cumulative count of 1 second periods that contain at least 1 Errored Block.
EB	Errored Block count - cumulative count of errored blocks.
SES	Severely errored Seconds - Cumulative count of 1 second periods with $\geq 2400$ Errored Blocks, or containing a "defect". Defects are LOS, LOF and MS-AIS.
UNAV	Unavailability - Cumulative count of unavailable seconds. A period of unavailability begins at the start of 10 or more consecutive severely errored seconds, and ends at the start of 10 or more consecutive <b>non</b> severely errored seconds.
ESR	Error Second Ratio - The ratio of errored seconds to the total seconds of available time. A period of unavailability begins at the start of 10 or more consecutive Severely Errored Seconds, and ends at the start of 10 or more <b>non</b> Severely Errored Seconds.
SESR	Severely Errored Second Ratio - The ratio of severely errored seconds to the total seconds of available time.
BBEC	Background Block error count - Cumulative count of errored blocks which occur outwith a severely errored second.
BBER	Background Block error Ratio - The ratio of errored blocks to total blocks. Total blocks excludes severely errored seconds and periods of unavailability.

Result Definitions  
**SDH Error Analysis**

**G.826 Analysis MS-REI**

These calculations are based on "Errored Blocks". A Block is a set of consecutive bits associated with the Path. Each bit belongs to one and only one block. If an STM-4 interface is selected an errored block is a REI with one or more bits in error.

**Table 3-3**

**G.826 Analysis MS-REI**

Display	Definition
ES	Errored Seconds - Cumulative count of 1 second periods that contain at least 1 Errored Block.
EB	Errored Block count - cumulative count of errored blocks.
SES	Severely errored Seconds - Cumulative count of 1 second periods with >= 2400 Errored Blocks, or MS-RDI.
UNAV	Unavailability - Cumulative count of unavailable seconds. A period of unavailability begins at the start of 10 or more consecutive severely errored seconds, and ends at the start of 10 or more consecutive <b>non</b> severely errored seconds.
ESR	Error Second Ratio - The ratio of errored seconds to the total seconds of available time. A period of unavailability begins at the start of 10 or more consecutive Severely Errored Seconds, and ends at the start of 10 or more <b>non</b> Severely Errored Seconds.
SESR	Severely Errored Second Ratio - The ratio of severely errored seconds to the total seconds of available time.
BBEC	Background Block error count - Cumulative count of errored blocks which occur outwith a severely errored second.
BBER	Background Block error Ratio - The ratio of errored blocks to total blocks.Total blocks excludes severely errored seconds and periods of unavailability.

**NOTE**

Near End Failures of LOS, LOF and MS-AIS produce "dead time" in the MS-REI measurement such that result accumulation is suspended.

Result Definitions  
**SDH Error Analysis**

**G.826 B3 BIP Analysis**

These calculations are based on "Errored Blocks". A Block is a set of consecutive bits associated with the Path. Each bit belongs to one and only one block.

**Table 3-4**

**G.826 Analysis B3 BIP**

Display	Definition
ES	Errored Seconds - Cumulative count of 1 second periods that contain at least 1 Errored Block.
EB	Errored Block count - cumulative count of errored blocks.
SES	Severely errored Seconds - Cumulative count of 1 second periods with >= 2400 Errored Blocks, or containing a "defect". Defects are LOS, LOF, MS-AIS, LOP and AU-AIS.
UNAV	Unavailability - Cumulative count of unavailable seconds. A period of unavailability begins at the start of 10 or more consecutive severely errored seconds, and ends at the start of 10 or more consecutive <b>non</b> severely errored seconds.
ESR	Error Second Ratio - The ratio of errored seconds to the total seconds of available time. A period of unavailability begins at the start of 10 or more consecutive Severely Errored Seconds, and ends at the start of 10 or more <b>non</b> Severely Errored Seconds.
SESR	Severely Errored Second Ratio - The ratio of severely errored seconds to the total seconds of available time.
BBEC	Background Block error count - Cumulative count of errored blocks which occur outwith a severely errored second.
BBER	Background Block error Ratio - The ratio of errored blocks to total blocks. Total blocks excludes severely errored seconds and periods of unavailability.
PUAS	Path Unavailable Second count - Logical OR of the Near and Far end unavailable seconds.

Result Definitions  
**SDH Error Analysis**

**G.826 HP-REI Analysis**

These calculations are based on "Errored Blocks". A Block is a set of consecutive bits associated with the Path. Each bit belongs to one and only one block.

**Table 3-5**

**G.826 Analysis HP-REI**

Display	Definition
ES	Errored Seconds - Cumulative count of 1 second periods that contain at least 1 Errored Block.
EB	Errored Block count - cumulative count of errored blocks.
SES	Severely errored Seconds - Cumulative count of 1 second periods with >= 2400 Errored Blocks, or HP-RDI.
UNAV	Unavailability - Cumulative count of unavailable seconds. A period of unavailability begins at the start of 10 or more consecutive severely errored seconds, and ends at the start of 10 or more consecutive <b>non</b> severely errored seconds.
ESR	Error Second Ratio - The ratio of errored seconds to the total seconds of available time. A period of unavailability begins at the start of 10 or more consecutive Severely Errored Seconds, and ends at the start of 10 or more <b>non</b> Severely Errored Seconds.
SESR	Severely Errored Second Ratio - The ratio of severely errored seconds to the total seconds of available time.
BBEC	Background Block error count - Cumulative count of errored blocks which occur outwith a severely errored second.
BBER	Background Block error Ratio - The ratio of errored blocks to total blocks. Total blocks excludes severely errored seconds and periods of unavailability.
PUAS	Path Unavailable Second count - Logical OR of the Near and Far end unavailable seconds.

**NOTE**

Near End Failures of LOS, LOF, MS-AIS, AU-LOP and AU-AIS produce "dead time" in the HP-REI measurement such that result accumulation is suspended.

Result Definitions  
**SDH Error Analysis**

**G.826 HP-IEC Analysis**

These calculations are based on "Errored Blocks". A Block is a set of consecutive bits associated with the Path. Each bit belongs to one and only one block.

**Table 3-6**

**G.826 Analysis HP-IEC**

Display	Definition
ES	Errored Seconds - Cumulative count of 1 second periods that contain at least 1 Errored Block.
EB	Errored Block count - cumulative count of errored blocks.
SES	Severely errored Seconds - Cumulative count of 1 second periods with $\geq$ 2400 Errored Blocks, or containing a "defect". Defects are LOS, LOF, MS-AIS, LOP, AU-AIS and HP-RDI.
UNAV	Unavailability - Cumulative count of unavailable seconds. A period of unavailability begins at the start of 10 or more consecutive severely errored seconds, and ends at the start of 10 or more consecutive <b>non</b> severely errored seconds.
ESR	Error Second Ratio - The ratio of errored seconds to the total seconds of available time. A period of unavailability begins at the start of 10 or more consecutive Severely Errored Seconds, and ends at the start of 10 or more <b>non</b> Severely Errored Seconds.
SESR	Severely Errored Second Ratio - The ratio of severely errored seconds to the total seconds of available time.
BBEC	Background Block error count - Cumulative count of errored blocks which occur outwith a severely errored second.
BBER	Background Block error Ratio - The ratio of errored blocks to total blocks. Total blocks excludes severely errored seconds and periods of unavailability.
PUAS	Path Unavailable Second count - Logical OR of the Near and Far end unavailable seconds.

**NOTE**

Near End Failures of LOS, LOF, MS-AIS, AU-LOP and AU-AIS produce "dead time" in the HP-IEC measurement such that result accumulation is suspended.

Result Definitions  
**SDH Error Analysis**

**G.826 TU BIP Analysis - 34 Mb/s Payload**

These calculations are based on "Errored Blocks". A Block is a set of consecutive bits associated with the Path. Each bit belongs to one and only one block.

Table 3-7

**G.826 Analysis TU BIP - 34 Mb/s Payload**

Display	Definition
ES	Errored Seconds - Cumulative count of 1 second periods that contain at least 1 Errored Block.
EB	Errored Block count - cumulative count of errored blocks.
SES	Severely errored Seconds - Cumulative count of 1 second periods with $\geq$ 2400 Errored Blocks, or containing a "defect". Defects are LOS, LOF, MS AIS, LOP, AU-AIS, H4 LOM, TU3-AIS and TU3-LOP.
UNAV	Unavailability - Cumulative count of unavailable seconds. A period of unavailability begins at the start of 10 or more consecutive severely errored seconds, and ends at the start of 10 or more consecutive <b>non</b> severely errored seconds.
ESR	Error Second Ratio - The ratio of errored seconds to the total seconds of available time. A period of unavailability begins at the start of 10 or more consecutive Severely Errored Seconds, and ends at the start of 10 or more <b>non</b> Severely Errored Seconds.
SESR	Severely Errored Second Ratio - The ratio of severely errored seconds to the total seconds of available time.
BBEC	Background Block error count - Cumulative count of errored blocks which occur outwith a severely errored second.
BBER	Background Block error Ratio - The ratio of errored blocks to total blocks.Total blocks excludes severely errored seconds and periods of unavailability.
PUAS	Path Unavailable Second count - Logical OR of the Near and Far end unavailable seconds.



Result Definitions  
**SDH Error Analysis**

**G.826 TU BIP Analysis - 2 Mb/s Payload**

These calculations are based on "Errored Blocks". A Block is a set of consecutive bits associated with the Path. Each bit belongs to one and only one block.

**Table 3-8**

**G.826 Analysis TU BIP - 2 Mb/s Payload**

Display	Definition
ES	Errored Seconds - Cumulative count of 1 second periods that contain at least 1 Errored Block.
EB	Errored Block count - cumulative count of errored blocks.
SES	Severely errored Seconds - Cumulative count of 1 second periods with $\geq 600$ Errored Blocks, or containing a "defect". Defects are LOS, LOF, MS AIS, LOP, AU-AIS, H4 LOM, TU-IS and TU-LOP.
UNAV	Unavailability - Cumulative count of unavailable seconds. A period of unavailability begins at the start of 10 or more consecutive severely errored seconds, and ends at the start of 10 or more consecutive <b>non</b> severely errored seconds.
ESR	Error Second Ratio - The ratio of errored seconds to the total seconds of available time. A period of unavailability begins at the start of 10 or more consecutive Severely Errored Seconds, and ends at the start of 10 or more <b>non</b> Severely Errored Seconds.
SESR	Severely Errored Second Ratio - The ratio of severely errored seconds to the total seconds of available time.
BBEC	Background Block error count - Cumulative count of errored blocks which occur outwith a severely errored second.
BBER	Background Block error Ratio - The ratio of errored blocks to total blocks. Total blocks excludes severely errored seconds and periods of unavailability.
PUAS	Path Unavailable Second count - Logical OR of the Near and Far end unavailable seconds.

Result Definitions  
**SDH Error Analysis**

**G.826 LP-REI Analysis - 34 Mb/s Payload**

These calculations are based on "Errored Blocks". A Block is a set of consecutive bits associated with the Path. Each bit belongs to one and only one block.

**Table 3-9**

**G.826 Analysis LP-REI, 34 Mb/s Payload**

Display	Definition
ES	Errored Seconds - Cumulative count of 1 second periods that contain at least 1 Errored Block.
EB	Errored Block count - cumulative count of errored blocks.
SES	Severely errored Seconds - Cumulative count of 1 second periods with >= 2400 Errored Blocks, or LP-RDI.
UNAV	Unavailability - Cumulative count of unavailable seconds. A period of unavailability begins at the start of 10 or more consecutive severely errored seconds, and ends at the start of 10 or more consecutive <b>non</b> severely errored seconds.
ESR	Error Second Ratio - The ratio of errored seconds to the total seconds of available time. A period of unavailability begins at the start of 10 or more consecutive Severely Errored Seconds, and ends at the start of 10 or more <b>non</b> Severely Errored Seconds.
SESR	Severely Errored Second Ratio - The ratio of severely errored seconds to the total seconds of available time.
BBEC	Background Block error count - Cumulative count of errored blocks which occur outwith a severely errored second.
BBER	Background Block error Ratio - The ratio of errored blocks to total blocks.Total blocks excludes severely errored seconds and periods of unavailability.
PUAS	Path Unavailable Second count - Logical OR of the Near and Far end unavailable seconds.

**NOTE**

Near End Failures of LOS, LOF, MS-AIS, AU-LOP, AU-AIS, H4 LOM, TU-LOP and TU-AIS produce "dead time" in the LP-REI measurement such that result accumulation is suspended.

Result Definitions  
**SDH Error Analysis**

**G.826 LP-REI Analysis - 2 Mb/s Payload**

These calculations are based on "Errored Blocks". A Block is a set of consecutive bits associated with the Path. Each bit belongs to one and only one block.

**Table 3-10**

**G.826 Analysis LP-REI - 2 Mb/s Payload**

Display	Definition
ES	Errored Seconds - Cumulative count of 1 second periods that contain at least 1 Errored Block.
EB	Errored Block count - cumulative count of errored blocks.
SES	Severely errored Seconds - Cumulative count of 1 second periods with >= 600 Errored Blocks, or TU3 Path FERF .
UNAV	Unavailability - Cumulative count of unavailable seconds. A period of unavailability begins at the start of 10 or more consecutive severely errored seconds, and ends at the start of 10 or more consecutive <b>non</b> severely errored seconds.
ESR	Error Second Ratio - The ratio of errored seconds to the total seconds of available time. A period of unavailability begins at the start of 10 or more consecutive Severely Errored Seconds, and ends at the start of 10 or more <b>non</b> Severely Errored Seconds.
SESR	Severely Errored Second Ratio - The ratio of severely errored seconds to the total seconds of available time.
BBEC	Background Block error count - Cumulative count of errored blocks which occur outwith a severely errored second.
BBER	Background Block error Ratio - The ratio of errored blocks to total blocks.Total blocks excludes severely errored seconds and periods of unavailability.
PUAS	Path Unavailable Second count - Logical OR of the Near and Far end unavailable seconds.

**NOTE**

Near End Failures of LOS, LOF, MS-AIS, AU-LOP, AU-AIS, H4 LOM, TU-LOP and TU-AIS produce "dead time" in the LP-REI measurement such that result accumulation is suspended.

Result Definitions  
**SDH Pointer Value Results**

---

## SDH Pointer Value Results

**Table 3-11**                      **Pointer Value**

Display	Definition
Pointer Value	The received Pointer value.
NDF	The number of seconds containing one or more active New Data Flag
Missing NDF	The number of seconds containing one or more VC moves with no accompanying active New Data Flag.
POS ADJUSTMENTS	The number of positive pointer adjustments in the measurement period and the number of seconds in the measurement period which contain one or more positive adjustments.
NEG ADJUSTMENTS	The number of negative pointer adjustments in the measurement period and the number of seconds in the measurement period which contain one or more negative adjustments.
IMPLIED VC4 OFFSET	The total number of positive and negative pointer movements during the measurement are counted and the implied mean VC offset, is calculated in ppm.

Result Definitions  
**SDH Pointer Value Results**

**SDH Alarm Seconds**

**Table 3-12**

**SDH Alarm Seconds**

Alarm	Payload	STM-1	STM-4
Power Loss	Yes	Yes	Yes
Loss of Signal (LOS)	Yes	Yes	Yes
Loss of Frame (LOF)	Yes	Yes	Yes
Out of Frame (OOF)	Yes	Yes	Yes
Loss of Pointer (AU-LOP)	Yes	Yes	No
MS-AIS	Yes	Yes	Yes
K1K2 Change (A1T[A1U] only)	Yes	Yes	Yes
AU-AIS	Yes	Yes	No
MS-RDI	Yes	Yes	Yes
HP-RDI	Yes	Yes	No
H4 LOM	Not 140 Mb/s Payload	No	No
TU-LOP	Not 140 Mb/s Payload	No	No
TU-AIS	Not 140 Mb/s Payload	No	No
LP-RDI	Not 140 Mb/s Payload	No	No

Result Definitions  
**Frequency Measurement**

---

**Frequency Measurement**

Frequency measurement is available at standard PDH and SDH rates.

The measured frequency is displayed in Hz with 1 Hz resolution.

Offset from the standard rate is displayed in Hz and ppm (parts per million).

---

**Optical Power**

Optical Power measurement is available for SDH optical signals.

The received optical power, 0 to -30dBm is displayed with an accuracy of  $\pm 1$ dB.

Result Definitions  
**Optical Power**

---

## **SDH Logging Messages**



## **Logging Devices**

Results may be logged to the Disc Drive. A bit map of graphics results can be recorded on the disk drive by using the screen dump feature.

If Remote Control Option A3X is fitted, results may be logged to the Internal Printer.

If Remote Control Option A3B or A3D, is fitted the following types of External printer can be used for results logging:

- HP-IB HP 550C DeskJet printer
- RS-232-C HP 550C DeskJet printer
- An alternative suppliers RS-232-C printer

The alternative suppliers RS-232-C printer can be 40 column width or 80 column width. If a 40 column width printer is used Graphics results cannot be logged.

- A Centronics parallel printer

SDH Logging Messages  
**Results Logging**

---

## Results Logging

Header and results are logged to the selected device when:

- **PRINT NOW** is pressed.
- If LOGGING [ON] is selected on the **OTHER LOGGING** display and a measurement is started by pressing **RUN/STOP**

```
=====
                        Hewlett Packard HP37717C
                        Instrument Configuration
=====
RECEIVER
Receive Signal   : STM-1 ELECTRICAL
Level           : TERMINATE
Mapping         : AU-4      VC-4      140 Mb/s
Payload Type    : UNFRAMED
Pattern         : 2^23-1      Polarity      : INVERTED
MEASUREMENT STARTED 23 Jul 97 10:27:13      Print Period 10 Minutes
=====
```

### Logging Header Example

If **PRINT NOW** is pressed the cumulative results are logged. If a measurement is in progress the current results are logged. If a measurement is not in progress the cumulative results for the last measurement are logged.

### During the Measurement Period

If LOG ERROR SECOND [ON] is selected on the **OTHER LOGGING** display all occurrences of an Error Second will be logged:

- Bit
- Code (PDH)
- Frame (PDH)
- CRC (PDH)
- REBE (PDH)
- DS3 Frame (SDH)
- DS3 P-Bit (SDH)

## SDH Logging Messages

### Results Logging

- DS3 C-Bit (SDH)
- DS3 FEBE (SDH)
- DS1 Frame (SDH)
- DS1 CRC6 (SDH)
- A1A2 FRAME (SDH)
- RS B1 BIP/B1 BIP (SDH)
- MS B2 BIP/B2 BIP (SDH)
- MS FEBE/RS REI (SDH)
- Path B3 BIP/B3 BIP (SDH)
- Path FEBE/HP REI (SDH)
- Path IEC/HP IEC (SDH)
- TU Path BIP (SDH)
- TU Path FEBE/LP REI (SDH)
- Hit Count (Jitter)
- Hit seconds (Jitter)
- Positive Peak Amplitude (Jitter)
- Negative Peak Amplitude (Jitter)
- Peak to Peak Amplitude (Jitter)
- RMS Amplitude (Jitter)
- Positive Peak (2Mb/s Wander)
- Negative Peak (2Mb/s Wander)
- Peak to Peak (2Mb/s Wander)
- Peak to Peak (15 min) (2Mb/s Wander)
- Peak to Peak (24 hours) (2Mb/s Wander)
- Time Interval Error (2Mb/s Wander)
- Estimated Bit Slips (2Mb/s Wander)
- Estimated Frame Slips (2Mb/s Wander)
- EM BIP (ATM)

## SDH Logging Messages

### Results Logging

- FEBE/REI (ATM)
- Corrected HEC (ATM)
- Non Corrected HEC (ATM)
- Cell Loss (ATM)
- Errored Cells (ATM)
- Misinserted Cells (ATM)

All Alarm occurrences will be logged both when set and cleared:

- Signal Loss
- AIS (PDH & ATM)
- Pattern Sync Loss (PDH & ATM)
- Loss Of Frame (SDH, PDH & ATM)
- Out Of Frame (SDH)
- Multiframe (PDH)
- Remote Loss (PDH)
- Remote Multiframe Loss (PDH)
- Loss of Pointer (SDH)
- MS AIS (SDH)
- Path AIS/AU AIS (SDH)
- Pattern Loss (SDH)
- Clock Loss (SDH)
- MS FERF/MS RDI (SDH)
- Path FERF/HP RDI (SDH)
- K1K2 Change (SDH)
- H4 Multiframe Loss (SDH)
- TU Loss of Pointer (SDH)
- TU AIS (SDH)
- TU Path FERF/LP RDI (SDH)
- DS3 Frame Loss (SDH)

## SDH Logging Messages

### Results Logging

- DS3 AIS (SDH)
- DS3 FERF (SDH)
- DS1 Frame Loss (SDH)
- DS1 AIS (SDH)
- DS1 FERF (SDH)
- Jitter Lock Loss (Option UHN[US9])
- Excess Jitter (Option UHN[US9])
- Excess Wander (Option UHN[US9])
- Wander Ref Loss (Option UHN[US9])
- Wander Signal Loss (Option UHN[US9])
- FERF/RDI (ATM)
- Loss of Cell Sync (ATM)
- Selected Cell Not Received (ATM)
- Congestion Experienced (ATM)
- Test Cell Loss (ATM)
- VP AIS (ATM)
- VP FERF/VP RDI (ATM)
- VC AIS (ATM)
- VC FERF/VC RDI (ATM)

In addition the following events are logged:

- All Alarms Clear
- Power Failure
- Power Restored
- New Day
- Squelched - Printing stopped to conserve paper during period of Unavailability
- Unsquelched - Printing restarted after period of Unavailability
- Print Demanded - if **PRINT NOW** is pressed.

## SDH Logging Messages

### Results Logging

- Print Period - if selected on **OTHER LOGGING** display.
- Printing Enabled - if Printer enabled during a measurement.
- Measurement Complete

```
| 10:27:32 LOS SET
| 10:27:32 LOF SET
| 10:27:32 OOF SET
| 10:27:32 AU-LOP SET
| 10:27:32 Pattern Loss SET
| 10:27:35 LOS CLEAR
| 10:27:35 LOF CLEAR
| 10:27:35 OOF CLEAR
| 10:27:35 AU-LOP CLEAR
| 10:27:35 Pattern Loss CLEAR
| 10:27:35 OOF SET
| 10:27:35 OOF CLEAR
| 10:27:35 ALL ALARMS CLEAR
| 10:27:36 Pattern Loss SET
| 10:27:36 Pattern Loss CLEAR
| 10:27:37 ALL ALARMS CLEAR
| 10:27:41 OOF SET
| 10:27:41 OOF CLEAR
| 10:27:42 Pattern Loss SET
| 10:27:42 Pattern Loss CLEAR
| 10:27:42 ALL ALARMS CLEAR
| 10:27:44 OOF SET
| 10:27:44 OOF CLEAR
| 10:27:45 Pattern Loss SET
| 10:27:45 Pattern Loss CLEAR
| 10:27:46 ALL ALARMS CLEAR
| 10:28:42 LOS SET
| 10:28:42 LOF SET
| 10:28:42 OOF SET
| 10:28:42 AU-LOP SET
| 10:28:42 Pattern Loss SET
| 10:28:44 LOS CLEAR
| 10:28:44 LOF CLEAR
| 10:28:44 OOF CLEAR
| 10:28:44 AU-LOP CLEAR
| 10:28:44 Pattern Loss CLEAR
| 10:28:44 OOF SET
| 10:28:44 OOF CLEAR
| 10:28:44 ALL ALARMS CLEAR
| 10:28:45 Pattern Loss SET
| 10:28:45 Pattern Loss CLEAR
| 10:28:46 ALL ALARMS CLEAR
```

### Logging During Measurement Example

SDH Logging Messages  
Results Logging

**At the End of the Measurement Period**

A complete set of measurement results are logged.

```

=====
MEASUREMENT COMPLETE 23 Jul 97 10:28:57 Elapsed Time 00d 00h 01m 43s
=====
Cumulative Results

Error Results :
          A1A2      RS B1      MS B2      MS-      PATH B3
          FRAME    BIP      BIP      REI      BIP
Error Count      393      93      307      1.065E+06      244201
Error Ratio      9.860E-06      5.761E-09      1.923E-08      6.965E-05      1.565E-05

          HP-      HP-      TU      LP-
          REI      IEC      BIP      REI
Error Count      69      239895      N/A      N/A
Error Ratio      4.617E-09      1.605E-05      N/A      N/A

          BIT (test)      CODE      CRC      REBE
Error Count      2.463E+08      N/A      N/A      N/A
Error Ratio      1.704E-02      N/A      N/A      N/A

Analysis Results :
          G.826 ANALYSIS
          RS B1      MS B2      MS-      PATH B3
          BIP      BIP      REI      BIP
Errored Blocks      20      23      64000      79708
Errored Seconds      10      10      10      39
Severely Errored Seconds      6      6      9      18
Unavailable Seconds      0      0      0      0
Path Unavailable Seconds      N/A      0      0      0
Background Block Errors      14      16      1      10477
Errored Second Ratio      9.709E-02      9.709E-02      1.031E-01      3.786E-01
Severely Errored Sec Ratio      5.825E-02      5.825E-02      9.278E-02      1.748E-01
Background Block Err Ratio      1.804E-05      2.062E-05      1.420E-06      1.541E-02

          HP-      HP-      TU      LP-
          REI      IEC      BIP      REI
Errored Blocks      10      122155      N/A      N/A
Errored Seconds      4      3      N/A      N/A
Severely Errored Seconds      0      0      N/A      N/A
Unavailable Seconds      0      19      N/A      N/A
Path Unavailable Seconds      0      N/A      N/A      N/A
Background Block Errors      10      9      N/A      N/A
Errored Second Ratio      4.124E-02      3.846E-02      N/A      N/A
Severely Errored Sec Ratio      0      0      N/A      N/A
Background Block Err Ratio      1.289E-05      1.442E-05      N/A      N/A

          G.821 ANALYSIS
          BIT (test)      FAS 140M      FAS 34M      FAS 8M      FAS 2M
Errored Sec      14      N/A      N/A      N/A      N/A
%Errored Sec      13.59223      N/A      N/A      N/A      N/A
%ES (Annex D)      6.79612      N/A      N/A      N/A      N/A
Error Free Sec      89      N/A      N/A      N/A      N/A
%Error Free Sec      86.40777      N/A      N/A      N/A      N/A
Severely Err Sec      14      N/A      N/A      N/A      N/A
%Severely Err Sec      13.59223      N/A      N/A      N/A      N/A
Degraded Minutes      0      N/A      N/A      N/A      N/A
%Degraded Minutes      0.00000      N/A      N/A      N/A      N/A
Unavailable Sec      0      N/A      N/A      N/A      N/A
%Unavailable Sec      0.00000      N/A      N/A      N/A      N/A

```

## SDH Logging Messages Results Logging

G.826 ANALYSIS				
	Near 140Mb/s	Far	Near 34Mb/s	Far
Errored Seconds	6	N/A	N/A	N/A
Severely Errored Seconds	6	N/A	N/A	N/A
Unavailable Seconds	0	N/A	N/A	N/A
Errored Second Ratio	5.825E-02	N/A	N/A	N/A
Severely Errored Sec Ratio	5.825E-02	N/A	N/A	N/A
M.2100 ANALYSIS				
	Rx 140Mb/s	Tx	Rx 34Mb/s	Tx
Errored Seconds	14	N/A	N/A	N/A
Severely Errored Seconds	14	N/A	N/A	N/A
Unavailable Seconds	0	N/A	N/A	N/A
M.2110 ANALYSIS				
BIS Results		2-hr WAIT	24-hr WAIT	7-day WAIT
Frequency :	N/A Hz	Offset :	N/AHz	Offset :
				N/Appm
Pointer Results :				
	AU POINTER		TU POINTER	
	Count	Seconds	Count	Seconds
NDF		3		N/A
Missing NDF		4		N/A
+ve Pointer Adjustments	3	3	N/A	N/A
-ve Pointer Adjustments	5	4	N/A	N/A
Implied VC Offset	0.0		N/A	N/A
Pointer Value	256		N/A	

### Logging At End of Measurement Example

#### Bar Graph Logging

To log the Bar Graphs:

On the **OTHER LOGGING** display, LOGGING SETUP **DEVICE**, select the required logging device under LOGGING PORT .

On the **OTHER LOGGING** CONTROL display, select LOGGING [ON] .

Display the Bar Graphs required on the Bar Graph display and press **PRINT** .

Select **THIS SCREEN**

The Error Summary, the Alarm Summary, the selected Bar Graphs and the Alarms Graph are logged.



## SDH Logging Messages Results Logging

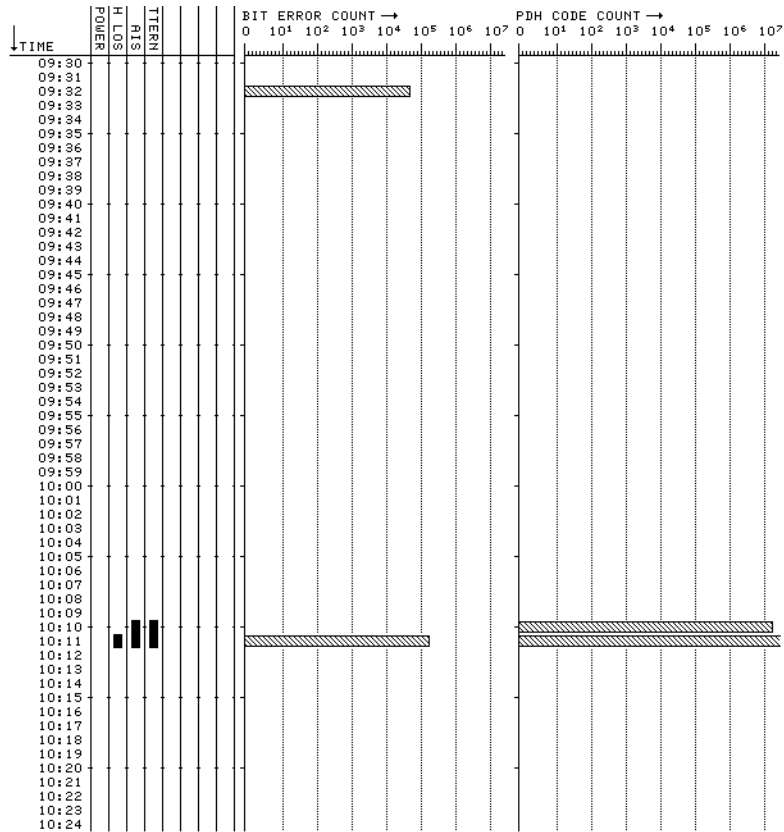

### Bar Graph Logging Example

### Graphics Text Results Logging

To log the Alarm Summaries:

Select the required logging device under LOGGING PORT on the **OTHER LOGGING** display.

Select LOGGING [ON] on the **OTHER LOGGING** display.

Display the results required on the Text Results display and press **PRINT**.

The Error Summary and Alarm Summary are logged.

SDH Logging Messages  
**Results Logging**

**Results Snapshot Logging**

To log the Results Snapshot:

Select the required External logging device under LOGGING PORT on the **OTHER LOGGING** display.

Select LOGGING [ON] on the **OTHER LOGGING** display.

Select LOG ON DEMAND [RESULTS] on the **OTHER LOGGING** display and press **PRINT NOW**.

```

=====
Hewlett Packard HP37717C
Instrument Configuration
=====
RECEIVER
Receive Signal : STM-1 ELECTRICAL
Level          : TERMINATE
Mapping        : AU-4      VC-4      140 Mb/s
Payload Type   : UNFRAMED
Pattern        : 2^23-1      Polarity      : INVERTED

MEASUREMENT STARTED 23 Jul 97 10:35:59      Print Period 10 Minutes
=====
10:37:19 PRINT DEMANDED- RESULTS SNAPSHOT      Elapsed Time 00d 00h 01m 20s
=====
Cumulative Results

Error Results :
              A1A2      RS B1      MS B2      MS-      PATH B3
              FRAME    BIP        BIP        REI      BIP
Error Count   293      81633     261      876107   95
Error Ratio   9.538E-06  6.561E-06  2.121E-08  7.793E-05  7.899E-09

              HP-      HP-      TU      LP-
              REI      IEC      BIP      REI
Error Count   23      607484   N/A     N/A
Error Ratio   1.961E-09  5.181E-05  N/A     N/A

              BIT (test)      CODE      CRC      REBE
Error Count   1.840E+08     N/A     N/A     N/A
Error Ratio   1.651E-02     N/A     N/A     N/A

Analysis Results :
              G.826 ANALYSIS
              RS B1      MS B2      MS-      PATH B3
              BIP        BIP        REI      BIP
Errored Blocks 42284     18      45573   20
Errored Seconds 19        5        12     5
Severely Errored Seconds 9        3        11     3
Unavailable Seconds 0        0        0     0
Path Unavailable Seconds N/A      0        0     0
Background Block Errors 643     12      2189   18
Errored Second Ratio 2.375E-01  6.250E-02  1.558E-01  6.250E-02
Severely Errored Sec Ratio 1.125E-01  3.750E-02  1.429E-01  3.750E-02
Background Block Err Ratio 1.132E-03  1.948E-05  4.146E-03  2.922E-05

```

## SDH Logging Messages Results Logging

	HP- REI	HP- IEC	TU BIP	LP- REI	
Errored Blocks	5	316822	N/A	N/A	
Errored Seconds	2	1	N/A	N/A	
Severely Errored Seconds	0	0	N/A	N/A	
Unavailable Seconds	0	40	N/A	N/A	
Path Unavailable Seconds	0	N/A	N/A	N/A	
Background Block Errors	5	1426	N/A	N/A	
Errored Second Ratio	2.597E-02	2.703E-02	N/A	N/A	
Severely Errored Sec Ratio	0	0	N/A	N/A	
Background Block Err Ratio	8.117E-06	4.818E-03	N/A	N/A	
G.821 ANALYSIS					
	BIT (test)	FAS 140M	FAS 34M	FAS 8M	FAS 2M
Errored Sec	9	N/A	N/A	N/A	N/A
%Errored Sec	11.25000	N/A	N/A	N/A	N/A
%ES (Annex D)	5.00000	N/A	N/A	N/A	N/A
Error Free Sec	71	N/A	N/A	N/A	N/A
%Error Free Sec	88.75000	N/A	N/A	N/A	N/A
Severely Err Sec	9	N/A	N/A	N/A	N/A
%Severely Err Sec	11.25000	N/A	N/A	N/A	N/A
Degraded Minutes	0	N/A	N/A	N/A	N/A
%Degraded Minutes	0.00000	N/A	N/A	N/A	N/A
Unavailable Sec	0	N/A	N/A	N/A	N/A
%Unavailable Sec	0.00000	N/A	N/A	N/A	N/A
G.826 ANALYSIS					
		Near 140Mb/s	Far	Near 34Mb/s	Far
Errored Seconds		3	N/A	N/A	N/A
Severely Errored Seconds		3	N/A	N/A	N/A
Unavailable Seconds		0	N/A	N/A	N/A
Errored Second Ratio		3.750E-02	N/A	N/A	N/A
Severely Errored Sec Ratio		3.750E-02	N/A	N/A	N/A
M.2100 ANALYSIS					
		Rx 140Mb/s	Tx	Rx 34Mb/s	Tx
Errored Seconds		9	N/A	N/A	N/A
Severely Errored Seconds		9	N/A	N/A	N/A
Unavailable Seconds		0	N/A	N/A	N/A
M.2110 ANALYSIS					
BIS Results		2-hr WAIT	24-hr WAIT	7-day WAIT	
Frequency :	155520000 Hz	Offset :	+0Hz	Offset :	+0.0ppm
Pointer Results :	AU POINTER		TU POINTER		
	Count	Seconds	Count	Seconds	
NDF		3			N/A
Missing NDF		2			N/A
+ve Pointer Adjustments	3	3	N/A		N/A
-ve Pointer Adjustments	1	1	N/A		N/A
Implied VC Offset	-0.0		N/A		
Pointer Value	512		N/A		

## Results Snapshot Logging Example

SDH Logging Messages  
Results Logging

**Overhead Capture Logging**

To log the Overhead Capture:

Select the required External logging device under LOGGING PORT on the **OTHER** **LOGGING** display.

Select LOGGING [ON] on the **OTHER** **LOGGING** display.

Select LOG ON DEMAND [O/H CAPTURE] on the **OTHER** **LOGGING** display and press **PRINT NOW**.

```
=====
10:58:17 PRINT DEMANDED- O/H CAPTURE           Elapsed Time  00d 00h 00m 02s
=====
| Setup : STM-1e
| Capture of channel [ 3xA1, 3xA2 ] Trigger OFF
-----
          DATA                FRAME COUNT
          F6F6F6282828         64000
          F6F6F6282828         64000
          F6F6F6282828         40041
          B626D6289828          1002
          F6F6F6282828         64000
          3636C4F82828           10
          B626D6289828          1002
          F6F6F6282828         64000
=====
```

**Overhead Capture Logging Example**



SDH Logging Messages  
**Results Logging**

**SDH Tributary Scan Logging**

To log the SDH Tributary Scan:

Select the required External logging device under LOGGING PORT on the **OTHER LOGGING** display.

Select LOGGING [ON] on the **OTHER LOGGING** display.

Select LOG ON DEMAND [TRIB SCAN] on the **OTHER LOGGING** display and press **PRINT NOW**.

```

=====
11:20:26 PRINT DEMANDED- TRIBUTARY SCAN          Elapsed Time  00d 00h 00m 10s
=====
RECEIVE SIGNAL      : STM-1
MAPPING             : AU-4   TU-12
TEST TIME           : 10 SECS
ERROR THRESHOLD     : > 0
-----
TU-12
TRIBS
      TUG-3 #1
-----
TUG-2 #1 | TUG-2 #2 | TUG-2 #3 | TUG-2 #4 | TUG-2 #5 | TUG-2 #6 | TUG-2 #7
-----
#1 PASS | #1 PASS | #1 PASS | #1 PASS | #1 PASS | #1 PASS | #1 PASS
#2 PASS | #2 PASS | #2 PASS | #2 PASS | #2 PASS | #2 PASS | #2 PASS
#3 PASS | #3 PASS | #3 PASS | #3 PASS | #3 PASS | #3 PASS | #3 PASS
-----
      TUG-3 #2
-----
TUG-2 #1 | TUG-2 #2 | TUG-2 #3 | TUG-2 #4 | TUG-2 #5 | TUG-2 #6 | TUG-2 #7
-----
#1 PASS | #1 PASS | #1 PASS | #1 PASS | #1 PASS | #1 PASS | #1 PASS
#2 PASS | #2 PASS | #2 PASS | #2 PASS | #2 PASS | #2 PASS | #2 PASS
#3 PASS | #3 PASS | #3 PASS | #3 PASS | #3 PASS | #3 PASS | #3 PASS
-----
      TUG-3 #3
-----
TUG-2 #1 | TUG-2 #2 | TUG-2 #3 | TUG-2 #4 | TUG-2 #5 | TUG-2 #6 | TUG-2 #7
-----
#1 PASS | #1 PASS | #1 PASS | #1 PASS | #1 PASS | #1 PASS | #1 PASS
#2 PASS | #2 PASS | #2 PASS | #2 PASS | #2 PASS | #2 PASS | #2 PASS
#3 PASS | #3 PASS | #3 PASS | #3 PASS | #3 PASS | #3 PASS | #3 PASS
=====

```

**SDH Tributary Scan Logging Example**

SDH Logging Messages  
**Results Logging**

**Pointer Graph Logging**

To log the Pointer Graph:

Select the required External logging device under LOGGING PORT on the **OTHER** **LOGGING** display.

Select LOGGING [ON] on the **OTHER** **LOGGING** display.

Select LOG ON DEMAND [PTR GRAPH] on the **OTHER** **LOGGING** display and press **PRINT NOW**.

```

=====
11:31:16 PRINT DEMANDED- POINTER GRAPH           Elapsed Time  00d 00h 01m 22s
=====
CAPTURE INTERVAL      : 1 Second
POINTER UNDER TEST   : AU-4
=====

```

Period	MAX	MIN	Period	MAX	MIN	Period	MAX	MIN	Period	MAX	MIN
1	0	-18	73	UR	UR	145	NR	NR	217	NR	NR
2	UR	UR	74	UR	UR	146	NR	NR	218	NR	NR
3	UR	UR	75	UR	UR	147	NR	NR	219	NR	NR
4	UR	UR	76	UR	UR	148	NR	NR	220	NR	NR
5	UR	UR	77	UR	UR	149	NR	NR	221	NR	NR
6	UR	UR	78	UR	UR	150	NR	NR	222	NR	NR
7	UR	UR	79	UR	UR	151	NR	NR	223	NR	NR
8	UR	UR	80	UR	UR	152	NR	NR	224	NR	NR
9	UR	UR	81	UR	UR	153	NR	NR	225	NR	NR
10	UR	UR	82	UR	UR	154	NR	NR	226	NR	NR
11	UR	UR	83	NR	NR	155	NR	NR	227	NR	NR
12	UR	UR	84	NR	NR	156	NR	NR	228	NR	NR
13	UR	UR	85	NR	NR	157	NR	NR	229	NR	NR
14	UR	UR	86	NR	NR	158	NR	NR	230	NR	NR
15	UR	UR	87	NR	NR	159	NR	NR	231	NR	NR
16	UR	UR	88	NR	NR	160	NR	NR	232	NR	NR
17	UR	UR	89	NR	NR	161	NR	NR	233	NR	NR
18	UR	UR	90	NR	NR	162	NR	NR	234	NR	NR
19	UR	UR	91	NR	NR	163	NR	NR	235	NR	NR
20	UR	UR	92	NR	NR	164	NR	NR	236	NR	NR
21	UR	UR	93	NR	NR	165	NR	NR	237	NR	NR
22	UR	UR	94	NR	NR	166	NR	NR	238	NR	NR
23	UR	UR	95	NR	NR	167	NR	NR	239	NR	NR
24	UR	UR	96	NR	NR	168	NR	NR	240	NR	NR
25	UR	UR	97	NR	NR	169	NR	NR	241	NR	NR
26	UR	UR	98	NR	NR	170	NR	NR	242	NR	NR
27	UR	UR	99	NR	NR	171	NR	NR	243	NR	NR
28	UR	UR	100	NR	NR	172	NR	NR	244	NR	NR
29	UR	UR	101	NR	NR	173	NR	NR	245	NR	NR
30	UR	UR	102	NR	NR	174	NR	NR	246	NR	NR
31	UR	UR	103	NR	NR	175	NR	NR	247	NR	NR
32	UR	UR	104	NR	NR	176	NR	NR	248	NR	NR
33	UR	UR	105	NR	NR	177	NR	NR	249	NR	NR
34	UR	UR	106	NR	NR	178	NR	NR	250	NR	NR
35	UR	UR	107	NR	NR	179	NR	NR	251	NR	NR
36	UR	UR	108	NR	NR	180	NR	NR	252	NR	NR
37	UR	UR	109	NR	NR	181	NR	NR	253	NR	NR
38	UR	UR	110	NR	NR	182	NR	NR	254	NR	NR
39	UR	UR	111	NR	NR	183	NR	NR	255	NR	NR

SDH Logging Messages  
**Results Logging**

40	UR	UR	112	NR	NR	184	NR	NR	256	NR	NR
41	UR	UR	113	NR	NR	185	NR	NR	257	NR	NR
42	UR	UR	114	NR	NR	186	NR	NR	258	NR	NR
43	UR	UR	115	NR	NR	187	NR	NR	259	NR	NR
44	UR	UR	116	NR	NR	188	NR	NR	260	NR	NR
45	UR	UR	117	NR	NR	189	NR	NR	261	NR	NR
46	UR	UR	118	NR	NR	190	NR	NR	262	NR	NR
47	UR	UR	119	NR	NR	191	NR	NR	263	NR	NR
48	UR	UR	120	NR	NR	192	NR	NR	264	NR	NR
49	UR	UR	121	NR	NR	193	NR	NR	265	NR	NR
50	UR	UR	122	NR	NR	194	NR	NR	266	NR	NR
51	UR	UR	123	NR	NR	195	NR	NR	267	NR	NR
52	UR	UR	124	NR	NR	196	NR	NR	268	NR	NR
53	UR	UR	125	NR	NR	197	NR	NR	269	NR	NR
54	UR	UR	126	NR	NR	198	NR	NR	270	NR	NR
55	UR	UR	127	NR	NR	199	NR	NR	271	NR	NR
56	UR	UR	128	NR	NR	200	NR	NR	272	NR	NR
57	UR	UR	129	NR	NR	201	NR	NR	273	NR	NR
58	UR	UR	130	NR	NR	202	NR	NR	274	NR	NR
59	UR	UR	131	NR	NR	203	NR	NR	275	NR	NR
60	UR	UR	132	NR	NR	204	NR	NR	276	NR	NR
61	UR	UR	133	NR	NR	205	NR	NR	277	NR	NR
62	UR	UR	134	NR	NR	206	NR	NR	278	NR	NR
63	UR	UR	135	NR	NR	207	NR	NR	279	NR	NR
64	UR	UR	136	NR	NR	208	NR	NR	280	NR	NR
65	UR	UR	137	NR	NR	209	NR	NR	281	NR	NR
66	UR	UR	138	NR	NR	210	NR	NR	282	NR	NR
67	UR	UR	139	NR	NR	211	NR	NR	283	NR	NR
68	UR	UR	140	NR	NR	212	NR	NR	284	NR	NR
69	UR	UR	141	NR	NR	213	NR	NR	285	NR	NR
70	UR	UR	142	NR	NR	214	NR	NR	286	NR	NR
71	UR	UR	143	NR	NR	215	NR	NR	287	NR	NR
72	UR	UR	144	NR	NR	216	NR	NR	288	NR	NR

**Pointer Graph Logging Example**



SDH Logging Messages  
**Results Logging**

---

## **SDH Self Test Error Codes**

## SDH Self Test Error Codes

When self test is run fail numbers may be displayed. The fail numbers and a description are listed below.

**Table 5-3 Processor Self Test**

No.	Description	No.	Description
1020	SRAM Error	1021	SRAM Error
1022	SRAM Error	1023	SRAM Error
1024	SRAM Address Error	1040	RS232 DCD
1041	RS232 R1	1042	RS232 DSR
1043	RS232 CTS	1044	RS232 Rx too many bytes
1045	RS232 Tx time out	1046	RS232 Rx too few bytes
1047	RS232 Tx/Rx Data t	1052	HP-IB Driver Chip
1060	Real Time Clock Set Incorrectly	1061	Real Time Clock Not Ticking correctly
1070	Parallel Port No Send Data	1080	Internal Printer
1081	Keyboard Processor Internal RAM	1082	Keyboard Processor External RAM
1083	Keyboard Processor ROM	1084	Front Panel No Response
1085	Front Panel Bad Command	1086	Front Panel Invalid Error Returned
1087	Front Panel CPU or UART	1088	Cannot Detect Front Panel Printer
1090	VRAM Data Error	1100	No Disk in Drive
1101	Disk Full	1102	Disk Write Fail
1103	Disk Read Fail	1104	Disk Verify Read/Write Fail
1110	LAN Failed Power-On Test	1111	LAN Returned Invalid Error Number
1112	LAN Hardware Not Found	1113	Lan Fitted No Test Result
1120	Front Panel No Response	1121	Front Panel Bad Command
1122	Front Panel Returned Invalid Error Number	1123	Dual Port SRAM Data Error
1124	Dual Port SRAM Address Error	1130	Front Panel No Response
1131	Front Panel Bad Command	1132	Front Panel Returned Invalid Error Number
1133	Front Panel FEPRAM Sum-check Error	1140	Front Panel No Response
1141	Front Panel Bad Command	1142	Front Panel Returned Invalid Error Number
1143	Front Panel SRAM Data Error	1144	Front Panel SRAM Address Error
1145	Front Panel Address Range Invalid	1150	Front Panel No Response
1151	Front Panel Bad Command	1152	Front Panel Returned Invalid Error Number
1153	Front Panel VRAM Data Error	1154	Front Panel Stored Fonts Corrupted

## SDH Self Test Error Codes

**Table 5-3 Processor Self Test**

No.	Description	No.	Description
1155	Front Panel Address Range Invalid	1156	Front Panel VGA Controller Error
1160	Front Panel No Response	1161	Front Panel Bad Command
1162	Front Panel Returned Invalid Error Number	1163	Front Panel UART Tx/Rx Error Internal
1164	Front Panel Internal Loopback not Reset	1166	Front Panel UART Tx/Rx Error External

**Table 5-4 SDH Tests Option A3R (STM-1)**

No.	Description	No.	Description
721	Sync Loss	724	Bit Errors
731	Monitor, False Sync	741	Rx loss of Signal

**Table 5-5 SDH Tests Option A3R (STM-1, Overhead)**

No.	Description	No.	Description
7101	Overhead processor failed	7102	Path Overhead fail
7104	section Overhead fail	7111	VC4 J1 fail
7121	B1 Error Add, Sync Loss	7123	B1 Errors, Result Low
7124	B1 Errors, Result High	7131	B2 Error Add, Sync Loss
7133	B2 Errors, Result Low	7134	B2 Errors, Result High
7141	B3 Error Add, Sync Loss	7143	B3 Errors, Result Low
7144	B3 Errors, Result High	7151	MS-REI Error Add, Sync Loss
7153	MS-REIE Errors, Result Low	7154	RS-REI Errors, Result High
7161	PIEC Error Add, Sync Loss	7163	PIEC Errors, Result Low
7164	PIEC Errors, Result High		
7171	Error Add Off - Loss of Frame	7172	Error Add 1 in 4 - Loss of Frame

## SDH Self Test Error Codes

**Table 5-5 SDH Tests Option A3R (STM-1, Overhead)**

No.	Description	No.	Description
7173	Error Add 2 in 4 - Loss of Frame	7174	Error Add 3 in 4 - Loss of Frame
7175	Error Add 4 in 4 - Frame Sync	7176	Error Add 3 in 4 - Frame Sync
7177	Error Add 2 in 4 - Loss of Frame	7178	Error Add 1 in 4 - Loss of Frame
7179	Error Add Off - Loss of Frame		

**Table 5-6 SDH Tests Option A3R (140 Mb/s Payload)**

No.	Description	No.	Description
7181	Bit Errors - Sync Loss	7183	Bit Errors - Result Low
7184	Bit Errors - Result High	7191	Error Add 1E3, Offset +100 ppm - Sync Loss
7193	Error Add 1E3, Offset +100 ppm - Result Low	7194	Error Add 1E3, Offset +100 ppm - Result High
7201	Error Add 1E3, Offset -100 ppm - Sync Loss	7203	Error Add 1E3, Offset -100 ppm - Result Low
7204	Error Add 1E3, Offset -100 ppm - Result High		

**Table 5-7 SDH Tests Option A3R (TU3 Payload)**

No.	Description	No.	Description
7211	VC3 J1 Fail	7221	VC3 B3 Single Error - Sync Loss
7223	VC3 B3 Single Error - Result Low	7224	VC3 B3 Single Error - Result High
7231	VC3 REI Single Error - Sync Loss	7233	VC3 REI Single Error - Result Low
7234	VC3 REI Single Error - Result High	7241	Payload Bit Single Error - Sync Loss
7243	Payload Bit Single Error - Result Low	7244	Payload Bit Single Error - Result High
7251	Background Pattern - RX False Sync	7261	Background Pattern - TUG 1 Pattern Loss
7262	Background Pattern - TUG 3 Pattern Loss		

## SDH Self Test Error Codes

**Table 5-8 SDH Tests Option A3R (TU12 Payload Overhead)**

No.	Description	No.	Description
7271	Async - A1,A2 Sync Loss	7284	Async - B1 Errors
7294	Async - B2 errors	7304	Async - B3 Errors
7314	Async - REI Errors	7324	Async - V5 BIP2 Errors
7334	Async - V5 REI Errors	7341	Floating Byte - A1,A2 Sync Loss
7354	Floating Byte - B1 Errors	7364	Floating Byte - B2 Errors
7374	Floating Byte - B3 Errors	7384	Floating Byte - REI Errors
7394	Floating Byte - V5 BIP2 Errors	7404	Floating Byte - V5 BIP2 Errors
7411	Async V5 BIP2 Add - Sync Loss	7413	Async V5 BIP2 Add - Result Low
7414	Async V5 BIP2 Add - Result High	7421	Async V5 REI Add - Sync Loss
7423	Async V5 REI Add - Result Low	7424	Async V5 REI Add - Result High
7431	Async Payload Bit Add - Sync Loss	7433	Async Payload Bit Add - Result Low
7434	Async Payload Bit Add - Result High	7441	Floating Byte Payload Bit Add - Sync Loss
7433	Floating Byte Payload Bit Add - Result Low	7434	Floating Byte Payload Bit Add - Result High

**Table 5-9 SDH Tests Option A3R (Payload Pattern)**

No.	Description	No.	Description
7451	140 Mb/s, PRBS23 - Sync Loss	7453	140 Mb/s, PRBS23 - Result Low
7454	140 Mb/s, PRBS23 - Result High	7461	TU3, PRBS15 - Sync Loss
7463	TU3, PRBS15 - Result Low	7464	TU3, PRBS15 - Result High
7471	TU12, WORD - Sync Loss	7473	TU12, WORD - Result Low
7474	TU12, WORD - Result High	7481	TU2, PRBS9 - Sync Loss
7483	TU2, PRBS9 - Result Low	7484	TU2, PRBS9 - Result High
7491	Background PRBS9 - False Pattern Sync TUG1	7501	Background PRBS9 - False Pattern Sync TUG2

## SDH Self Test Error Codes

**Table 5-10 SDH Tests Option A3R (TU12 Payload Bit Error Add)**

No.	Description	No.	Description
7511	Sync Loss	7513	Result Low
7514	Result High		

**Table 5-11 SDH Tests Option A3R (Freq Offset/Pointer Movements)**

No.	Description	No.	Description
7521	140 Mb/s, A1,A2 - Sync Loss	7531	140 Mb/s, H1,H2 - Loss of Pointer
7544	140 Mb/s, B1 - Errors	7554	140 Mb/s, B2 - Errors
7564	140 Mb/s, B3 - Errors	7573	140 Mb/s, +100 ppm - Implied VC Offset Low
7574	140 Mb/s, +100 ppm - Implied VC Offset High	7583	140 Mb/s, -100 ppm - Implied VC Offset Low
7584	140 Mb/s, -100 ppm - Implied VC Offset High	7591	TU3, A1,A2 - Sync Loss
7601	TU3, H1,H2 - Loss of Pointer	7614	TU3, B1 - Errors
7624	TU3, B2 - Errors	7634	TU3, B3 - Errors
7644	TU3, TU BIP - Errors	7653	TU3, +100 ppm - Implied VC Offset Low
7654	TU3, +100 ppm - Implied VC Offset High	7663	TU3, -100 ppm - Implied VC Offset Low
7664	TU3, -100 ppm - Implied VC Offset High	7671	TU12, A1,A2 - Sync Loss
7681	TU12, H1,H2 - Loss of Pointer	7694	TU12, B1 - Errors
7704	TU12, B2 - Errors	7714	TU12, B3 - Errors
7724	TU12, TU BIP - Errors	7733	TU12, +100 ppm - Implied VC Offset Low
7734	TU12, +100 ppm - Implied VC Offset High	7743	TU12, -100 ppm - Implied VC Offset Low
7744	TU12, -100 ppm - Implied VC Offset High		

**Table 5-12 SDH Tests Option A3R (Thru Mode and DCC)**

No.	Description	No.	Description
-----	-------------	-----	-------------

## SDH Self Test Error Codes

**Table 5-12 SDH Tests Option A3R (Thru Mode and DCC)**

7751	Thru Mode - H4 Frame Sync Loss	7761	RS DCC Loopback Fail
7771	MS DCC Loopback Fail		

**Table 5-13 SDH Tests Option A3R (Bulk Filled Payload Pattern)**

No.	Description	No.	Description
7781	AU-4 Bulk - False Sync	7782	AU-4 Bulk - Sync Loss
7791	TU-3 Bulk - False Sync	7792	TU-3 Bulk - Sync Loss
7801	TU-12 Bulk - False Sync	7802	TU-12 Bulk - Sync Loss

**Table 5-14 SDH Tests Option A3R (DS3/DS1 Framing)**

No.	Description	No.	Description
7811	DS3 Unframed - False Sync	7812	DS3 Unframed - Sync Loss
7821	DS3 M23 - False Sync	7822	DS3 M23 - Sync Loss
7831	DS3 C-Bit - False Sync	7832	DS3 C-Bit - Sync Loss
7841	DS1 Unframed - False Sync	7842	DS1 Unframed - Sync Loss
7851	DS1 D4 - False Sync	7852	DS1 D4 - Sync Loss
7861	DS1 ESF - False Sync	7862	DS1 ESF - Sync Loss
7871	DS1 SLC-96 - False Sync	7872	DS1 SLC-96 - Sync Loss

**Table 5-15 SDH Tests Option A3R (STM-1 J0 Message)**

No.	Description	No.	Description
7881	No Errors		



## SDH Self Test Error Codes

**Table 5-16 SDH Tests Option A3R (Payload Patterns)**

No.	Description	No.	Description
7891	C-4 Bulk, PRBS11 - Sync Loss	7893	C-4 Bulk, PRBS11 - Result Low
7894	C-4 Bulk, PRBS11 - Result High	7901	C-3 Bulk, PRBS9 - Sync Loss
7903	C-3 Bulk, PRBS9 - Result Low	7904	C-3 Bulk, PRBS9 - Result High
7911	C-12 Bulk, Word - Sync Loss	7913	C-12 Bulk, Word - Result Low
7914	C-12 Bulk, Word - Result High	7921	DS3 Unframed PRBS20 - Sync Loss
7923	DS3 Unframed PRBS20 - Result Low	7924	DS3 Unframed PRBS20 - Result High
7931	DS1 Unframed QRSS - Sync Loss	7933	DS1 Unframed QRSS - Result Low
7934	DS1 Unframed QRSS - Result High		

**Table 5-17 SDH Tests Option A3R (Mixed Payloads)**

No.	Description	No.	Description
7945	TUG3 No 2,TU-3 Mapping - TU AIS Alarm	7946	TUG3 No 2,TU-3 Mapping - LP-RDIF Alarm
7947	TUG3 No 2,TU-3 Mapping - TU LOP Alarm	7951	TUG3 No 1,TU-3 Mapping - Sync Loss
7961	TUG3 No 3,TU-3 Mapping - Sync Loss	7975	TUG3 No 1,TU-12Mapping - TU AIS Alarm
7976	TUG3 No 1,TU-12Mapping - LP-RDI Alarm	7977	TUG3 No 1,TU-12Mapping - TU LOP Alarm
7981	TUG3 No 2, TU-12 Mapping - Sync Loss	7991	TUG3 No 3,TU-12Mapping - Sync Loss

**Table 5-18 SDH Tests Option A3R (TU-12 Background Pattern)**

No.	Description	No.	Description
22001	Unframed, PRBS9 - F/G Pattern Loss	22002	D4, PRBS9 - B/G Pattern Loss
22011	ESF, PRBS15 - F/G Pattern Loss	22012	D4, PRBS15- B/G Pattern Loss

## SDH Self Test Error Codes

**Table 5-19 SDH Tests Option A3R (Service Disruption Test)**

No.	Description	No.	Description
22021	Sync Loss	22025	Shortest Burst Error
22026	Longest Burst Error	22027	Last Burst Error
22035	Shortest Burst Error	22036	Longest Burst Error
22037	Last Burst Error	22045	Shortest Burst Error
22046	Longest Burst Error	22047	Last Burst Error

**Table 5-20 SDH Tests Option A3R (STM-0)**

No.	Description	No.	Description
22051	STM-0 Loopback - Signal Present	22061	STM-0 Loopback - Sync Loss
22064	STM-0 Loopback - Result High	22071	STM-0 Loopback - False Signal Present
22081	Pulse Shape HI - Sync Loss	22084	Pulse Shape HI - Result High
22091	Pulse Shape LO - Sync Loss	22094	Pulse Shape LO - Result High
22101	Pulse Shape XCONNECT - Sync Loss	22104	Pulse Shape XCONNECT - Result High
22111	Frequency Measurement - Signal Loss	22113	Frequency Measurement - Sync Loss
22114	Frequency Measurement - Result High	22121	C-3 Bulk Framing - False Sync
22122	C-3 Bulk Framing - Sync Loss	22131	TU-2 Bulk Framing - False Sync
22132	TU-12 Bulk Framing - Sync Loss	22141	DS1 Unframed - False Sync
22142	DS1 Unframed - Sync Loss	22151	B1 Error Add - Sync Loss
22153	B1 Error Add - Result Low	22154	B1 Error Add - Result High
22161	B2 Error Add - Sync Loss	22163	B2 Error Add - Result Low
22164	B2 Error Add - Result High	22171	B3 Error Add - Sync Loss
22173	B3 Error Add - Result Low	22174	B3 Error Add - Result High
22181	MS-REI Error Add - Sync Loss	22183	MS-REI Error Add - Result Low
22184	MS-REI Error Add - Result High	22191	IEC Error Add - Sync Loss
22193	IEC Error Add - Result Low	22194	IEC Error Add - Result High
22201	34 Mb/s Mapping, Offset +100ppm - Sync Loss	22203	34 Mb/s Mapping, Offset +100ppm - Result Low
22204	34 Mb/s Mapping, Offset +100ppm - Result High	22211	34 Mb/s Mapping, Offset -100ppm - Sync Loss
22213	34 Mb/s Mapping, Offset -100ppm - Result Low	22214	34 Mb/s Mapping, Offset -100ppm - Result High
22221	DS3 Mapping, Offset +100ppm - Sync Loss	22223	DS3 Mapping, Offset +100ppm - Result Low

## SDH Self Test Error Codes

**Table 5-20 SDH Tests Option A3R (STM-0)**

No.	Description	No.	Description
22224	DS3 Mapping, Offset +100ppm - Result High	22231	DS3 Mapping, Offset -100ppm - Sync Loss
22233	DS3 Mapping, Offset -100ppm- Result Low	22234	DS3 Mapping, Offset +100ppm - Result High
22241	THRU Mode Fail		

**Table 5-21 SDH Tests (Round Trip Delay)**

8911	STM-1, 140 Mb/s, 1μs- Pattern Loss	8913	STM-1, 140 Mb/s, 1μs - Result Low
8914	STM-1, 140 Mb/s, 1μs - Result High	8921	STM-1, 140 Mb/s, 2s - Pattern Loss
8923	STM-1, 140 Mb/s, 2s - Result Low	8924	STM-1, 140 Mb/s, 2s - Result High
8931	STM-1, 34 Mb/s, 1μs - Pattern Loss	8933	STM-1, 34 Mb/s, 1μs - Result Low
8934	STM-1, 34 Mb/s, 1μs - Result High	8941	STM-1, 34 Mb/s, 2s - Pattern Loss
8943	STM-1, 34 Mb/s, 2s - Result Low	8944	STM-1, 34 Mb/s, 2s - Result High
8951	STM-1, 2 Mb/s, 1μs - Pattern Loss	8953	STM-1, 2 Mb/s, 1μs - Result Low
8954	STM-1, 2 Mb/s, 1μs - Result High	8961	STM-1, 2 Mb/s, 2s - Pattern Loss
8963	STM-1, 2 Mb/s, 2s - Result Low	8964	STM-1, 2 Mb/s, 2s - Result High

**Table 5-22 Error Add Tests Options 130, 131**

No.	Description	No.	Description
10011	1310 nm STM-1 Pattern Sync Loss	10012	1310 nm STM-1 Signal Loss
10015	1550 nm STM-1 Pattern Sync Loss	10016	1550 nm STM-1 Signal Loss
10022	1310 nm STM-1 - Alarms Present	10026	1550 nm STM-1 - Alarms Present
10031	1310 nm STM-1, Error Add - Pattern Sync Loss	10033	1310 nm STM-1, Error Add - Bit Error Rate Low
10034	1310 nm STM-1, Error Add - Bit Error Rate High	10035	1550 nm STM-1, Error Add - Pattern Sync Loss

## SDH Self Test Error Codes

**Table 5-22 Error Add Tests Options 130, 131**

No.	Description	No.	Description
10037	1550 nm STM-1, Error Add - Bit Error Rate Low	10038	1550 nm STM-1, Error Add - Bit Error Rate High
10041	1310 nm TX OFF - No Alarms	10042	1310 nm TX OFF - No Signal Loss
10045	1550 nm TX OFF - No Alarms	10046	1550 nm TX OFF - No Signal Loss
10051	1310 nm STM-1 - Failed Frame Sync	10055	1550 nm STM-1 - Failed Frame Sync
10061	1310 nm STM-1 - Frame Alarm (LOF or OOF)	10065	1550 nm STM-1 - Frame Alarm (LOF or OOF)
10071	1310 nm STM-1 #1 - Alarms Present	10072	1310 nm STM-1 #1 - Signal Loss
10075	1550 nm STM-1 #1 - Alarms Present	10076	1550 nm STM-1 #1 - Signal Loss
10081	1310 nm STM-1 #1, Error Add - Pattern Sync Loss	10083	1310 nm STM-1 #1, Error Add - Bit Error Rate Low
10084	1310 nm STM-1 #1, Error Add - Bit Error Rate High	10085	1550 nm STM-1 #1, Error Add - Pattern Sync Loss
10087	1550 nm STM-1 #1, Error Add - Bit Error Rate Low	10088	1550 nm STM-1 #1, Error Add - Bit Error Rate High
10091	1310 nm STM-1 #1 - TX OFF - No Alarms	10092	1310 nm STM-1 #1 - TX OFF - No Signal Loss
10095	1550 nm STM-1 #1 - TX OFF - No Alarms	10096	1550 nm STM-1 #1 - TX OFF - No Signal Loss
10101	1310 nm STM-1 #2 - Alarms Present	10102	1310 nm STM-1 #2 - Signal Loss
10111	1310 nm STM-1 #2, Error Add - Pattern Sync Loss	10113	1310 nm STM-1 #2, Error Add - Bit Error Rate Low
10114	1310 nm STM-1 #2, Error Add - Bit Error Rate High	10121	1310 nm STM-1 #2 - TX OFF - No Alarms
10122	1310 nm STM-1 #2 - TX OFF - No Signal Loss	10131	1310 nm STM-1 #3 - Alarms Present
10132	1310 nm STM-1 #3 - Signal Loss	10141	1310 nm STM-1 #3, Error Add - Pattern Sync Loss
10143	1310 nm STM-1 #3, Error Add - Bit Error Rate Low	10144	1310 nm STM-1 #3, Error Add - Bit ErrorRate High
10151	1310 nm STM-1 #3 - TX OFF - No Alarms	10152	1310 nm STM-1 #3 - TX OFF - No Signal Loss
10161	1310 nm STM-1 #4 - Alarms Present	10162	1310 nm STM-1 #4 - Signal Loss
10171	1310 nm STM-1 #4, Error Add - Pattern Sync Loss	10173	1310 nm STM-1 #4, Error Add - Bit Error Rate Low
10174	1310 nm STM-1 #4, Error Add - Bit Error Rate High	10181	1310 nm STM-1 #4 - TX OFF - No Alarms
10182	1310 nm STM-1 #4 - TX OFF - No Signal Loss	10191	1310 nm STM-4 - Failed Frame Sync
10192	1310 nm STM-4 - B1 Errors	10195	1550 nm STM-4 - Failed Frame Sync
10196	1550 nm STM-4 - B1 Errors	10202	1310 nm STM-4 - B2 Errors

## SDH Self Test Error Codes

**Table 5-22 Error Add Tests Options 130, 131**

No.	Description	No.	Description
10206	1550 nm STM-4 - B2 Errors	10211	1310 nm STM-4, B2 Error Add - Frame Alarm (OOF or LOF)
10213	1310 nm STM-4, B2 Error Add - Bit Error Rate Low	10214	1310 nm STM-4, B2 Error Add - Bit ErrorRate High

**Table 5-23 Clock Recovery Tests Options 130, 131**

No.	Description	No.	Description
10221	STM-4, STM-1 #1 LOF, OOF or LOP	10222	STM-4, STM-1 #1 Signal Loss
10225	STM-4, STM-1 #1 LOF, OOF or LOP	10226	STM-4, STM-1 #1 Signal Loss
10231	STM-4 Clock Recovery LOF, OOF or LOP	10235	STM-4 Clock Recovery LOF, OOF or LOP
10241	STM-4 Clock Recovery LOF, OOF or LOP	10245	STM-4 Clock Recovery LOF, OOF or LOP
10251	STM-4 Clock Recovery LOF, OOF or LOP	10255	STM-4 Clock Recovery LOF, OOF or LOP

**Table 5-24 Overhead Tests Options 130, 131**

No.	Description	No.	Description
10261	STM-4 Overhead Pattern 1 - Fail to Sync	10262	STM-4 Overhead Pattern 1 - Pattern Error
10271	STM-4 Overhead Pattern 1 - Fail to Sync	10272	STM-4 Overhead Pattern 1 - Pattern Error
10281	STM-1 Overhead Pattern 1, Columns 1,4,7 - Fail to Sync	10282	STM-1 Overhead Pattern 1, Columns1,4,7 - Pattern Error
10291	STM-1 Overhead Pattern 1, Columns 2,5,8 - Fail to Sync	10292	STM-1 Overhead Pattern 1, Columns2,5,8 - Pattern Error
10301	STM-1 Overhead Pattern 1, Columns 3,6,9 - Fail to Sync	10302	STM-1 Overhead Pattern 1, Columns3,6,9 - Pattern Error
10311	STM-1 Overhead Pattern 2, Columns 1,4,7 - Fail to Sync	10312	STM-1 Overhead Pattern 2, Columns1,4,7 - Pattern Error
10321	STM-1 Overhead Pattern 2, Columns 2,5,8 - Fail to Sync	10322	STM-1 Overhead Pattern 2, Columns2,5,8 - Pattern Error

## SDH Self Test Error Codes

**Table 5-24 Overhead Tests Options 130, 131**

No.	Description	No.	Description
10331	STM-1 Overhead Pattern 2, Columns 3,6,9 - Fail to Sync	10332	STM-1 Overhead Pattern 2, Columns 3,6,9 - Pattern Error
10341	STM-1 #1 Overhead Pattern 1, Columns 1,4,7 - Fail to Sync	10342	STM-1 #1 Overhead Pattern 1, Columns 1,4,7 - Pattern Error
10351	STM-1 #1 Overhead Pattern 1, Columns 2,5,8 - Fail to Sync	10352	STM-1 #1 Overhead Pattern 1, Columns 2,5,8 - Pattern Error
10361	STM-1 #1 Overhead Pattern 1, Columns 3,6,9 - Fail to Sync	10362	STM-1 #1 Overhead Pattern 1, Columns 3,6,9 - Pattern Error
10371	STM-1 #2 Overhead Pattern 1, Columns 1,4,7 - Fail to Sync	10372	STM-1 #2 Overhead Pattern 1, Columns 1,4,7 - Pattern Error
10381	STM-1 #2 Overhead Pattern 1, Columns 2,5,8 - Fail to Sync	10382	STM-1 #2 Overhead Pattern 1, Columns 2,5,8 - Pattern Error
10391	STM-1 #2 Overhead Pattern 1, Columns 3,6,9 - Fail to Sync	10392	STM-1 #2 Overhead Pattern 1, Columns 3,6,9 - Pattern Error
10401	STM-1 #3 Overhead Pattern 1, Columns 1,4,7 - Fail to Sync	10402	STM-1 #3 Overhead Pattern 1, Columns 1,4,7 - Pattern Error
10411	STM-1 #3 Overhead Pattern 1, Columns 2,5,8 - Fail to Sync	10412	STM-1 #3 Overhead Pattern 1, Columns 2,5,8 - Pattern Error
10421	STM-1 #3 Overhead Pattern 1, Columns 3,6,9 - Fail to Sync	10422	STM-1 #3 Overhead Pattern 1, Columns 3,6,9 - Pattern Error
10431	STM-1 #4 Overhead Pattern 1, Columns 1,4,7 - Fail to Sync	10432	STM-1 #4 Overhead Pattern 1, Columns 1,4,7 - Pattern Error
10441	STM-1 #4 Overhead Pattern 1, Columns 2,5,8 - Fail to Sync	10442	STM-1 #4 Overhead Pattern 1, Columns 2,5,8 - Pattern Error
10451	STM-1 #4 Overhead Pattern 1, Columns 3,6,9 - Fail to Sync	10452	STM-1 #4 Overhead Pattern 1, Columns 3,6,9 - Pattern Error
10461	STM-1 #1 Overhead Pattern 2, Columns 1,4,7 - Fail to Sync	10462	STM-1 #1 Overhead Pattern 2, Columns 1,4,7 - Pattern Error
10471	STM-1 #1 Overhead Pattern 2, Columns 2,5,8 - Fail to Sync	10472	STM-1 #1 Overhead Pattern 2, Columns 2,5,8 - Pattern Error
10481	STM-1 #1 Overhead Pattern 2, Columns 3,6,9 - Fail to Sync	10482	STM-1 #1 Overhead Pattern 2, Columns 3,6,9 - Pattern Error
10491	STM-1 #2 Overhead Pattern 2, Columns 1,4,7 - Fail to Sync	10492	STM-1 #2 Overhead Pattern 2, Columns 1,4,7 - Pattern Error

## SDH Self Test Error Codes

**Table 5-24 Overhead Tests Options 130, 131**

No.	Description	No.	Description
10501	STM-1 #2 Overhead Pattern 2, Columns 2,5,8 - Fail to Sync	10502	STM-1 #2 Overhead Pattern 2, Columns 2,5,8 - Pattern Error
10511	STM-1 #2 Overhead Pattern 2, Columns 3,6,9 - Fail to Sync	10512	STM-1 #2 Overhead Pattern 2, Columns 3,6,9 - Pattern Error
10521	STM-1 #3 Overhead Pattern 2, Columns 1,4,7 - Fail to Sync	10522	STM-1 #3 Overhead Pattern 2, Columns 1,4,7 - Pattern Error
10531	STM-1 #3 Overhead Pattern 2, Columns 2,5,8 - Fail to Sync	10532	STM-1 #3 Overhead Pattern 2, Columns 2,5,8 - Pattern Error
10541	STM-1 #3 Overhead Pattern 2, Columns 3,6,9 - Fail to Sync	10542	STM-1 #3 Overhead Pattern 2, Columns 3,6,9 - Pattern Error
10551	STM-1 #4 Overhead Pattern 2, Columns 1,4,7 - Fail to Sync	10552	STM-1 #4 Overhead Pattern 2, Columns 1,4,7 - Pattern Error
10561	STM-1 #4 Overhead Pattern 2, Columns 2,5,8 - Fail to Sync	10562	STM-1 #4 Overhead Pattern 2, Columns 2,5,8 - Pattern Error
10571	STM-1 #4 Overhead Pattern 2, Columns 3,6,9 - Fail to Sync	10572	STM-1 #4 Overhead Pattern 2, Columns 3,6,9 - Pattern Error

**Table 5-25 STM-4 Alarms Options 130, 131**

No.	Description	No.	Description
10591	1310 nm, No Frame Errors - OOF Alarm Test Fail	10592	1310 nm, No Frame Errors - LOF Alarm Test Fail
10601	1310 nm, 3 in 4 Frame Errors - OOF Alarm Test Fail	10602	1310 nm, 3 in 4 Frame Errors - LOF Alarm Test Fail
10611	1310 nm, No Alarms - Pattern Sync Loss	10622	1310 nm, MS-AIS Alarm - Alarm Not Detected
10632	1310 nm, No Alarms - MS-AIS Alarm	10641	1310 nm, No Alarms - Pattern Sync Loss
10652	1310 nm, MS-RDI Alarm - Alarm Not Detected	10662	1310 nm, No Alarms - MS-RDI Alarm

## SDH Self Test Error Codes

**Table 5-26 Binary Interface Options 0YH with 130 or 131**

No.	Description	No.	Description
10701	STM-1 Binary - Signal Loss	10702	STM-1 Binary - Pattern Sync Loss
10711	STM-1 Binary, Error Add - Alarms Detected	10721	STM-1 Binary, Error Add - Pattern Sync Loss
10723	STM-1 Binary, Error Add - Bit Error Rate Low	10724	STM-1 Binary, Error Add - Bit Error Rate High
10731	STM-1 Binary, TX OFF - No Alarms	10732	STM-1 Binary, TX OFF - No Signal Loss
10751	STM-4 Binary, Error Add - No Alarms	10752	STM-4 Binary, Error Add - No Signal Loss
10761	STM-4 Binary, Error Add - Pattern Sync Loss	10763	STM-4 Binary, Error Add - Bit Error Rate Low
10764	STM-4 Binary, Error Add - Bit Error Rate High	10771	STM-4 Binary, TX OFF - No Alarms
10772	STM-4 Binary, TX OFF - No Signal Loss	10781	STM-4 Binary - Frame Sync Loss
10782	STM-4 Binary - B1 Errors	10792	STM-4 Binary - B2 Errors

**Table 5-27 Optical Power Measurement Options 130, 131**

No.	Description	No.	Description
10801	1310 nm STM-1 - Alarm Sync	10803	1310 nm STM-1 - Result Low
10804	1310 nm STM-1 - Result High	10805	1550 nm STM-1 - Alarm Sync
10807	1550 nm STM-1 - Result Low	10808	1550 nm STM-1 - Result High
10811	1310 nm STM-4 - Alarm Sync	10813	1310 nm STM-4 - Result Low
10814	1310 nm STM-4 - Result High	10815	1550 nm STM-4 - Alarm Sync
10817	1550 nm STM-4 - Result Low	10818	1550 nm STM-4 - Result High



## SDH Self Test Error Codes

---

**Table 5-28                      Frequency Measurement Options 130, 131**

No.	Description	No.	Description
10821	1310 nm STM-1 - Loss Of Signal	10823	1310 nm STM-1 - Result Low
10824	1310 nm STM-1 - Result High	10825	1550 nm STM-1 - Loss Of Signal
10827	1550 nm STM-1 - Result Low	10828	1550 nm STM-1 - Result High
10831	1310 nm STM-4 - Loss Of Signal	10833	1310 nm STM-4 - Result Low
10834	1310 nm STM-4 - Result High	10835	1550 nm STM-4 - Loss Of Signal
10837	1550 nm STM-4 - Result Low	10838	1550 nm STM-4 - Result High

---

**Table 5-29                      Error Add Tests Options 130, 131**

No.	Description	No.	Description
10841	1310 nm STM-4 B2 - Frame Sync Loss	10843	1310 nm STM-4 - B2 Error Rate Low
10844	1310 nm STM-4 - B2 Error Rate High	10853	1310 nm STM-4 - Frame Error Rate Low
10854	1310 nm STM-4 - Frame Error Rate High	10855	1310 nm STM-4 - B1 Error Rate Low
10856	1310 nm STM-4 - B1 Error Rate High	10857	1310 nm STM-4- MS FEBE//MS REI Error Rate Low
10858	1310 nm STM-4 - MS FEBE//MS REI Error Rate High		

## SDH Self Test Error Codes

**Table 5-30 STM-4 Stress Test Options 130, 131**

No.	Description	No.	Description
10861	1310 nm - Frame Sync Loss	10862	1310 nm - OOF Alarm
10865	1550 nm - Frame Sync Loss	10866	1550 nm - OOF Alarm

**Table 5-31 Loss of Signal Tests Options 130, 131**

No.	Description	No.	Description
10872	1310 nm - No Loss of Optical Signal	10873	1310 nm - Loss of Optical Signal
10876	1550 nm - No Loss of Optical Signal	10877	1550 nm - Loss of Optical Signal
10882	1310 nm - No Loss of Binary Signal	10883	1310 nm - Loss of Binary Signal
10886	1550 nm - No Loss of Binary Signal	10887	1550 nm - Loss of Binary Signal

**Table 5-32 STM-4c Tests Options 130, 131**

No.	Description	No.	Description
10891	1310 nm - POH J1 Byte error	10901	1310 nm, PRBS 2 <sup>23</sup> - Frame Sync Loss
10903	1310 nm, PRBS 2 <sup>23</sup> - Error Rate Low	10904	1310 nm, PRBS 2 <sup>23</sup> - Error Rate High
10911	1310 nm, PRBS 2 <sup>15</sup> - Frame Sync Loss	10913	1310 nm, PRBS 2 <sup>15</sup> - Error Rate Low
10914	1310 nm, PRBS 2 <sup>15</sup> - Error Rate High	10921	1310 nm, Word - Frame Sync Loss
10923	1310 nm, Word - Error Rate Low	10924	1310 nm, Word - Error Rate High
10931	1310 nm, PRBS 2 <sup>9</sup> - Frame Sync Loss	10933	1310 nm, PRBS 2 <sup>9</sup> - Error Rate Low
10934	1310 nm, PRBS 2 <sup>9</sup> - Error Rate High	10941	1310 nm, Frequency Offset - Frame Sync Loss
10942	1310 nm, Frequency Offset - Pointer Alarm	10943	1310 nm, Frequency Offset - B1 Bip Errors
10944	1310 nm, Frequency Offset - B2 Bip Errors	10945	1310 nm, Frequency Offset - B3 Bip Errors
10953	1310 nm, +100 ppm Offset - Result Low	10954	1310 nm, +100ppm Offset -Result High
10955	1310 nm, -100 ppm Offset - Result Low	10956	1310 nm, -100ppm Offset -Result High

## SDH Self Test Error Codes

**Table 5-33 STM-4 Payloads Tests Options 130, 131**

No.	Description	No.	Description
10961	Background Payload - Frame Sync Loss	10962	Background Payload - Errors Detected
10971	F/G Payload STM-1 #1 - Frame Sync Loss	10972	F/G Payload STM-1 #1 - Error Count Wrong
10973	F/G Payload STM-1 #2 - Frame Sync Loss	10974	F/G Payload STM-1 #2 - Error Count Wrong
10975	F/G Payload STM-1 #4 - Frame Sync Loss	10976	F/G Payload STM-1 #4 - Error Count Wrong
10981	ThruMode- H4Frame Fail	10991	Overhead Processor Fail
10992	STM-1-POHFail	10994	STM-1- SOH Fail
10995	RegeneratorSOHDCCFail	10996	Multiplexer SOH DCC Fail

---

## **Terminology**

Tables of ETSI Terms with their ANSI equivalents  
and current terms with their equivalent earlier terms.

## Terminology

### ETSI / ANSI Equivalent Terms

---

## ETSI / ANSI Equivalent Terms

The Terminology used on the instrument display is mainly ETSI terminology. The equivalent ANSI terminology is given in the following table

ETSI Term	ANSI Term
I-n Intra Office, STM-n	Intermediate Reach (IR)
L-n.1 or L-n.2 long haul	LR long reach
Multiplexer Section (MS)	Line
MS-AIS	AIS-L (Line AIS)
MS-BIP	Line BIP
MS-DCC	Line DCC
MS-RD (MS FERF)	RDI-L (Line FERF)
Multiplexer Section Overhead	Line Overhead
Network Node Interface	Line Interface
AU-AIS (Path AIS)	AIS-P
HP-RDI (Path FERF)	RDI-P
Regenerator	Repeater
Regenerator Section (RS)	Section
Remote Alarm Indicator	Yellow Alarm
Regenerator Section Overhead	Section Overhead
RS-DCC	Section DCC
S-n.1 or S-n.2 short haul	Short Reach (SR)
STM-n	STS-n
SOH	TOH
Section Overhead (SOH)	Transport Overhead (TOH)
Tributary Unit (TU)	Virtual Tributary (VT)

Terminology  
**ETSI / ANSI Equivalent Terms**

ETSI Term	ANSI Term
TU	VT
TU-AIS	VT AIS (AIS-V)
TU FERF / TU RDI	RDI-V / VT FERF
TU REI	VT FEBE
VC	SPE
Virtual Container	Payload Envelope
Virtual Container (VC)	Synchronous Payload Envelope (SPE)
VP-RDI (VP-FERF)	VP-RDI
VC-RDI (VC-FERF)	VC-RDI

NOTE: VC is an ETSI abbreviation for Virtual Container and an ETSI / ANSI abbreviation for (ATM) Virtual Channel. The context of VC must therefore be taken into account when converting between standards.

Terminology  
**Current / Previous Terminology**

---

**Current / Previous Terminology**

<b>Current Terminology</b>	<b>Previous Terminology</b>
B1 BIP	RS B1 BIP
B2 BIP	MS B2 BIP
B3 BIP	Path B3 BIP
MS-AIS	MS AIS
MS-RDI	MS RDI
MS-REI	MS FEBE
HP-IEC	Path IEC
AU-LOP	LOP
AU-AIS	Path AIS
HP-RDI	Path FERF
HP-REI	Path FEBE
TU-LOP	TU LOP
TU-AIS	TU Path AIS
LP-RDI	TU Path FERF
LP-REI	TU Path FEBE

---

# Index

---

- A**  
Add/Drop Multiplexer Testing, 6, 10  
Alarm Seconds  
    SDH, 76  
Alarm Stimulus/Response, 11  
Alarms  
    SDH, 12  
ANSI / ETSI Equivalent Terms, 116
- B**  
Bar Graph Logging, 87
- C**  
Cumulative Results  
    SDH, 64
- D**  
DCC Testing, 14, 15, 17  
Desynchroniser Stress, 18, 20
- E**  
ERROR ADD TYPE Selection, 13  
Error Summary, 62  
ETSI / ANSI Equivalent Terms, 116
- F**  
Frame Loss, 52  
Frame Synchronization, 21  
Frequency Measurement, 77
- G**  
G.826 Analysis  
    B1 BIP, 65  
    B2 BIP, 66  
    B3 BIP, 68  
    HP-IEC, 70  
    HP-REI, 69  
    LP-REI 2 Mb/s, 74  
    MS-REI, 67  
    TLP-REI 34 Mb/s, 73  
    TU BIP 2 Mb/s, 72  
    TU BIP 34 Mb/s, 71  
Graphics  
    Bar Graph Logging, 88  
    Logging Bar Graphs, 87
- I**  
Introduction to SDH, 2
- L**  
Logging At End of Measurement, 87  
Logging Bar Graphs, 88  
Logging Devices, 80  
Logging During Measurement, 85  
Logging Header, 81  
Logging Results  
    At end of Measurement, 86  
    Bar Graphs, 86  
    During Measurement, 81  
    Error & Alarm Summaries, 88  
    Graphics Text, 88  
    Logging Header, 81  
    Overhead Capture, 91  
    Overhead Snapshot, 92  
    Pointer Graph, 94  
    Result Snapshot, 89  
    Tributary Scan, 93
- M**  
MSP Stimulus/Response, 30, 34
- N**  
NetworkStress Testing  
    Desynchroniser Stress, 18
- O**  
Optical Clock Recovery Stress, 34, 35  
Optical Power Measurement, 77  
Overhead Capture Logging Example, 91  
Overhead Snapshot Logging Example, 92
- P**  
Payload Mapping/Demapping, 36, 41  
PDH Alarm Scan, 52, 55  
Performance Monitor Stimulus/Response, 45  
PerformanceMonitor Stimulus/Response, 42  
Pointer Graph Logging Example, 95
- R**  
Results Definitions  
    Cumulative SDH, 64  
    Error Summary, 62  
    Frequency Measurement, 77  
    G.826 B1 BIP Analysis, 65  
    G.826 B2 BIP Analysis, 66  
    G.826 B3 BIP Analysis, 68  
    G.826 HP-IEC, 70  
    G.826 HP-REI, 69  
    G.826 LP-REI 2 Mb/s, 74  
    G.826 LP-REI 34 Mb/s, 73  
    G.826 MS-REI, 67  
    G.826 TU BIP 2 Mb/s, 72  
    G.826 TU BIP 34 Mb/s, 71  
    Short Term, 62  
    Results Snapshot Logging Example, 90
- S**  
SDH Alarm Seconds, 76  
SDH Alarms, 12  
SDH Error Analysis, 65–74  
SDH Introduction, 2  
SDH Jitter Transfer, 27  
SDH measurement  
    option A3R {A3S}, 4  
SDH Options, 3  
SDH Results  
    Cumulative, 64  
    G.826 B1 BIP, 65  
    G.826 B2 BIP, 66  
    G.826 B3 BIP, 68  
    G.826 HP-IEC, 70  
    G.826 HP-REI, 69  
    G.826 LP-REI 2 Mb/s, 74  
    G.826 LP-REI 34 Mb/s, 73  
    G.826 MS-REI, 67  
    G.826 TU BIP 2 Mb/s, 72  
    G.826 TU BIP 34 Mb/s, 71  
    Short Term, 63  
Selective Jitter Transfer Measurement, 46  
Self Test error codes  
    processor tests, 98  
Short Term Results  
    SDH, 63
- T**  
Terminology  
    Current / previous, 118  
    ETSI / ANSI, 116  
Tributary Scan Logging Example, 93  
Trouble Scan, 62
-



---

## **Index**

---

## Hewlett-Packard Sales and Service Offices

If you need technical assistance with a Hewlett-Packard test and measurement product or application please contact the Hewlett-Packard office or distributor in your country.

### **Asia Pacific:**

#### ***Hong Kong:***

Tel: (852) 2599 7889

#### ***India:***

Tel: (91-11) 682-6000

#### ***Japan:***

Hewlett-Packard Japan Ltd.  
Measurement Assistance Center  
9-1, Takakura-Cho, Hachioji-Shi,  
Tokyo 192-8510, Japan  
Tel: (81) 426-56-7832  
Fax: (81) 426-56-7840

#### ***Korea:***

Tel: (82-2) 769 0800

#### ***Malaysia:***

Tel: (60-3) 291 0213

#### ***Philippines:***

Tel: (63-2) 894 1451

#### ***People's Republic of China:***

Tel: (86-10) 6505 0149

#### ***Singapore:***

Tel: (1800) 292 8100

#### ***Taiwan:***

Tel: (886-3) 492 9666

#### ***Thailand:***

Tel: (66-2) 661 3900

### ***For countries in Asia Pacific not listed, contact:***

Hewlett-Packard Asia Pacific Ltd  
17-21/F Shell Tower, Times Square,  
1 Matheson Street  
Causeway Bay  
Hong Kong  
Tel: (852) 2599 7777  
Fax: (852) 2506 9285

### **Australia/New Zealand:**

Hewlett-Packard Australia Ltd.  
31-41 Joseph Street  
Blackburn, Victoria 3130  
Australia  
Tel: 1 800 629 485

### **Canada:**

Hewlett-Packard Canada Ltd.  
5150 Spectrum Way  
Mississauga, Ontario  
L4W 5G1  
Tel: (905) 206 4725

### **Europe, Africa and Middle East:**

#### ***Austria:***

Tel: (0)1 25000-0

#### ***Belgium and Luxembourg:***

Tel: (02) 778 3417

#### ***Baltic Countries:***

Tel: (358) 08872 2100

#### ***Czech Republic:***

Tel: 420-2-4743111

#### ***Denmark:***

Tel: 45 99 10 00

## **Hewlett-Packard Sales and Service Offices (cont'd)**

***Finland:***

Tel: (90) 88 721

***France:***

Tel: (0)1 69.82.60.60

***Germany:***

Tel: (0180) 532 62-33

***Greece:***

Tel: 30-1-7264045

***Hungary:***

Tel: 36-1-4618219

***Ireland:***

Tel: (01) 284 4633

***Israel:***

Tel: 972-3-5380333

***Italy:***

Tel: 02 - 92 122 241

***Netherlands:***

Tel: (020) 547 6669

***Norway:***

Tel: (22) 73 57 50

***Poland:***

Tel: 48-22-6087700

***Portugal:***

Tel: (11) 482 85 00

***Russia:***

Tel: (7/095) 928 6885

Fax: (7/095) 916 9844

***South Africa:***

Tel: 27-22-8061000

***Spain:***

Tel: (34) 1 631 1323

***Sweden:***

Tel: (08) 444 22 77

***Switzerland:***

Tel: (01) 735 7111

***Turkey:***

Tel: 90-212-2245925

***United Kingdom:***

Tel: (01344) 366 666

***For countries in Europe/Middle East  
and Africa not listed, contact:***

Hewlett-Packard  
International Sales Europe  
Geneva, Switzerland  
Tel: +41-22-780-4111  
Fax: +41-22-780-4770

***Latin America:***

Hewlett-Packard  
Latin American Region Headquarters  
5200 Blue Lagoon Drive  
9th Floor  
Miami, Florida 33126  
U.S.A.  
Tel: (305) 267-4245  
Tel: (305) 267-4220  
Fax: (305) 267-4288

***United States:***

Hewlett-Packard Company  
Test and Measurement Organization  
5301 Stevens Creek Blvd.  
Bldg. 51L-SC  
Santa Clara, CA 95052-8059  
Tel: 1 800 452 4844

---

### **About This Edition**

This is the 1st edition of  
the 37717-90417 manual.  
It documents the product  
as of February 1998.  
Edition dates are as  
follows:

1st Edition, February 1998

© Copyright Hewlett-  
Packard Company 1998.  
All rights reserved.  
Reproduction, adaption,  
or translation without prior  
written permission is  
prohibited, except as  
allowed under the  
copyright laws.

## **In This Book**

This book provides information on HP 37717C modules with SDH capability. It also provides applications associated with these modules.

The individual applications contain techniques which may be of value for purposes other than those shown

Printed in U.K. 02/98  
37717-90417





## Artisan Technology Group is your source for quality new and certified-used/pre-owned equipment

- FAST SHIPPING AND DELIVERY
- TENS OF THOUSANDS OF IN-STOCK ITEMS
- EQUIPMENT DEMOS
- HUNDREDS OF MANUFACTURERS SUPPORTED
- LEASING/MONTHLY RENTALS
- ITAR CERTIFIED SECURE ASSET SOLUTIONS

### SERVICE CENTER REPAIRS

Experienced engineers and technicians on staff at our full-service, in-house repair center

### *InstraView*<sup>SM</sup> REMOTE INSPECTION

Remotely inspect equipment before purchasing with our interactive website at [www.instraview.com](http://www.instraview.com) ↗

### WE BUY USED EQUIPMENT

Sell your excess, underutilized, and idle used equipment. We also offer credit for buy-backs and trade-ins. [www.artisanng.com/WeBuyEquipment](http://www.artisanng.com/WeBuyEquipment) ↗

### LOOKING FOR MORE INFORMATION?

Visit us on the web at [www.artisanng.com](http://www.artisanng.com) ↗ for more information on price quotations, drivers, technical specifications, manuals, and documentation

**Contact us:** (888) 88-SOURCE | [sales@artisanng.com](mailto:sales@artisanng.com) | [www.artisanng.com](http://www.artisanng.com)