



Artisan Technology Group is your source for quality new and certified-used/pre-owned equipment

- FAST SHIPPING AND DELIVERY
- TENS OF THOUSANDS OF IN-STOCK ITEMS
- EQUIPMENT DEMOS
- HUNDREDS OF MANUFACTURERS SUPPORTED
- LEASING/MONTHLY RENTALS
- ITAR CERTIFIED SECURE ASSET SOLUTIONS

SERVICE CENTER REPAIRS

Experienced engineers and technicians on staff at our full-service, in-house repair center

*InstraView*SM REMOTE INSPECTION

Remotely inspect equipment before purchasing with our interactive website at www.instraview.com ↗

WE BUY USED EQUIPMENT

Sell your excess, underutilized, and idle used equipment. We also offer credit for buy-backs and trade-ins. www.artisanng.com/WeBuyEquipment ↗

LOOKING FOR MORE INFORMATION?

Visit us on the web at www.artisanng.com ↗ for more information on price quotations, drivers, technical specifications, manuals, and documentation

Contact us: (888) 88-SOURCE | sales@artisanng.com | www.artisanng.com

**HA9 SERIES
EXTENDED RANGE
PROGRAMMABLE OPTICAL ATTENUATOR
User's Manual**



Contents

Safety Information, Instructions, and Symbols	1
Safety Information	1
Classification	1
Disconnecting from Line Power	1
Line Power Requirements	1
Fuse Type.....	1
Safety Instructions.....	2
Before Initializing and Operating the Unit	2
Operating the Unit	2
Safety Symbols	4
Compliance	5
FCC Compliance	5
CE Compliance.....	5
UL Compliance	6
General Information and Specifications	7
General Information	7
Key Features	8
Applications	9
Standard Accessories.....	9
Optional Accessories	9
Specifications.....	10
Getting Started	12
Before Initializing and Operating the Unit.....	12
Initial Inspection.....	12
Operating Environment	13
Temperature	13
Humidity.....	13
Ventilation.....	13
Storing and Shipping.....	13
Claims and Repackaging.....	13
Returning Shipments to JDS Uniphase	14
Cleaning Connectors.....	14
Connecting and Setting the GPIB Interface	15
Connecting the RS232 Interface	16
Checking Optional Connections	17
Operating and Maintenance Instructions	18
Front Panel.....	18
Operating Keys.....	18
Status LEDs.....	19
Connector Panel.....	19
Rear Panel	19
Setting Operating Mode and Using the Attenuator.....	20
Turning the Beam Block On or Off	21

Setting the Calibration Wavelength.....	21
Setting the User Slope	22
Optimizing the Calibration Wavelength.....	22
Storing a User Slope.....	22
Setting the Display Offset.....	23
Setting the Display Offset in ATT Mode.....	23
Setting the Display Offset in PWR Mode	23
Setting the Power.....	24
Controlling the Driver.....	24
Resetting the Attenuator	24
Checking Attenuator Calibration.....	24
Required Equipment.....	24
Verifying Calibration.....	26
Verifying Insertion Loss	27
Maintaining the Attenuator	27
Programming Guide.....	29
Setting the GPIB Address and the Interface Command Set for Remote Operation	29
Switching between Remote and Local Operation.....	30
GPIB Interface Functions	30
RS232 Interface Functions.....	30
RS232 Programming Examples.....	31
HA9 and HPM Command Sets.....	32
Command Parser Rules.....	33
HA9/HPM Operation Commands	34
HA9/HPM Query Commands	36
Status Reporting and Service Request Control	39
Condition Register	39
Status Register	39
SRQ Mask Register	40
GPIB Programming Examples	41
SCPI Command Set	45
Program Message Formats	46
Terminating a Program Message.....	46
Command Header Variations.....	46
Specifying the Command Path	46
Default Commands.....	48
Parameter Types	48
Suffixes.....	49
Response Formats	50
Overview of Implemented Status Structures.....	51
Status Byte Register.....	54
Service Request Enable Register.....	55
Standard Event Status Register	55
Standard Event Status Enable Register	56
Operation and Questionable Condition Registers	56
Operation and Questionable Event Registers.....	57
Operation and Questionable Event Enable Registers	57

Operation and Condition Positive Transition Registers	57
Operation and Questionable Negative Transition Registers	58
Input Queue.....	58
Output Queue	59
Error Queue	59
Description of Error Numbers	59
SCPI Command Tree.....	63
Common Commands.....	66
DISPlay Commands.....	70
INPut Commands	71
OUTPut Commands	74
Status Commands	76
System Commands	80
User Commands.....	80
IEEE 488.2 Common Commands	81

***For sales and service information,
contact JDS Uniphase or your local representative.***

**JDS Uniphase Corporation
570 West Hunt Club Road
Nepean, Ontario, Canada
K2G 5W8
Phone: 613 727-1303
Fax: 613 727-8284
E-mail: sales@jdsunph.com
Website: <http://www.jdsunph.com>**

Safety Information, Instructions, and Symbols

Safety Information

Classification

The HA9 Series Extended Range Programmable Optical Attenuator consists of an exposed metal chassis that is connected directly to earth via a power cord and, therefore, is classified as a Class 1 instrument. Class 1 refers to equipment relying on ground protection as a means of shock protection.

The following symbol is used to indicate a protective conductor terminal in the unit.



Disconnecting from Line Power

Some of the circuits are powered whenever the unit is connected to the AC power source (line power). To ensure that the unit is not connected to the line power, disconnect the power cord from either the power inlet on the unit's rear panel or from the AC line-power source (receptacle). The power cord must always be accessible from one of these points. If the unit is installed in a cabinet, the operator must be able to disconnect the unit from the line power by the system's line-power switch.

Line Power Requirements

The unit can operate from any single-phase AC power source that supplies between 90 and 240 V at a frequency range of 50 to 60 Hz. The maximum power consumption is 80 VA.

Fuse Type

The fuse type used by the unit is (5x20) mm, T1A / 250 V (slow).

Safety Instructions

The following safety instructions must be observed whenever the unit is operated, serviced, or repaired. Failure to comply with any of these instructions or with any precaution or warning contained in the user's manual is in direct violation of the standards of design, manufacture, and intended use of the unit. JDS Uniphase assumes no liability for the customer's failure to comply with any of these safety requirements.

Before Initializing and Operating the Unit

- ☑ Inspect the unit for any signs of damage, and read the user's manual thoroughly.
- ☑ Install the unit as specified in the **Getting Started** section.
- ☑ Ensure that the unit and any devices or cords connected to it are properly grounded.

Operating the Unit





	<p>Warning</p> <p>To avoid the risk of injury or death, always observe the following precautions before initializing the unit:</p> <ul style="list-style-type: none">• If using a voltage-reducing autotransformer to power the unit, ensure that the common terminal connects to the earthed pole of the power source.• Use only the type of power cord supplied with the unit.• Connect the power cord only to a power outlet equipped with a protective earth contact. Never connect to an extension cord that is not equipped with this feature.• Willfully interrupting the protective earth connection is prohibited.• Never look into the end of an optical cable connected to an optical output device that is operating. Laser radiation is invisible, and direct exposure can severely injure the human eye. For more information, see the user's manual of the laser source in use.• Turning off the power to the device does not always block the externally supplied radiation to the connector at the output of the unit.• Do not use the unit outdoors.• To prevent potential fire or shock hazard, do not expose the unit to any source of excessive moisture.• Do not operate the unit when its covers or panels have been removed.• Do not interrupt the protective earth grounding. Any such action can lead to a potential shock hazard that can result in serious personal injury.• Do not operate the unit if an interruption to the protective grounding is suspected. In this case, ensure that the unit remains inoperative.• Use only the type of fuse specified by the manufacturer as appropriate for this unit. Do not use repaired fuses, and avoid any situations that can short-
---	--

	<p>circuit the fuse.</p> <ul style="list-style-type: none">• Unless absolutely necessary, do not attempt to adjust or perform any maintenance or repair procedure when the unit is opened and connected to a power source.• Repairs are to be carried out only by a qualified professional.• Do not attempt any adjustment, maintenance, or repair procedure to the unit's internal mechanism if immediate first aid is not accessible.• Disconnect the power cord from the unit before adding or removing any components.• Operating the unit in the presence of flammable gases or fumes is extremely hazardous.• Do not perform any operating or maintenance procedure that is not described in the user's manual.• Some of the unit's capacitors can be charged even when the unit is not connected to the power source.
--	--

Safety Symbols

The following symbols and messages can be marked on the unit (Table 1). Observe all safety instructions that are associated with a symbol.

Table 1: Safety Symbols

Symbol	Description
	Laser safety. See the user's manual for instructions on handling and operating the unit safely.
	See the user's manual for instructions on handling and operating the unit safely.
	Electrostatic discharge (ESD). See the user's manual for instructions on handling and operating the unit safely.
	Frame or chassis terminal for electrical grounding within the unit.
	Protective conductor terminal for electrical grounding to the earth.
WARNING	The procedure can result in serious injury or loss of life if not carried out in proper compliance with all safety instructions. Ensure that all conditions necessary for safe handling and operation are met before proceeding.
CAUTION	The procedure can result in serious damage to or destruction of the unit if not carried out in compliance with all instructions for proper use. Ensure that all conditions necessary for safe handling and operation are met before proceeding.

Compliance

FCC Compliance

The Federal Communications Commission (FCC) of the United States of America requires that equipment operating in that country does not cause interference to communications. The unit has been tested and found to comply with the limits for a Class A digital device, pursuant to Part 15 of Title 47 of the Code of Federal Regulations for Radio Frequency Devices. Operation is subject to the following two conditions, which the FCC requires to be labeled on the unit:

- This device may not cause harmful interference.
- This device must accept any interference received, including interference that may cause undesired operation.

FCC rules require that the following note and subsequent information be included in this manual:

Note: This equipment has been tested and found to comply with the limits for a Class A digital device, pursuant to part 15 of the FCC Rules. These limits are designed to provide reasonable protection against harmful interference when the equipment is operated in a commercial environment. This equipment generates, uses, and can radiate radio frequency energy and, if not installed and used in accordance with the instruction manual, may cause harmful interference to radio communications. Operation of this equipment in a residential area is likely to cause harmful interference in which case the user will be required to correct the interference at his own expense.

These limits are designed to provide reasonable protection against harmful interference in a commercial installation. The unit generates, uses, and radiates radio frequency energy and, if not installed and used in accordance with instructions, can cause harmful interference to radio communications.

Any user modification made to the unit voids the user's authority to operate the unit under the FCC rules.

If this unit is used in a residential setting, resulting interference must be corrected by the user.

For more information, see Title 47 of the Code of Federal Regulations at <http://www.access.gpo.gov/nara/cfr/cfr-table-search.html>.

CE Compliance

The unit has been designed and tested to comply with directive 73/23/EEC and its subsequent amendments by the European Community (EC or CE). The directive relates to electrical equipment designed for use within certain voltage limits. It ensures that electrical equipment is constructed with good engineering practice in safety matters.

The unit has been designed and tested to comply with directive 89/336/EEC and its subsequent amendments. The directive relates to electromagnetic compatibility. It demands that electromagnetic disturbance does not exceed a prescribed level; that the equipment be immune to a prescribed level of ambient level of interference; that the equipment be protected

against electrostatic discharges; and that the equipment be immune to all electrical shock wave disturbances. As of 1997, measures have been added to test for fire hazard, electric shock hazard, and also external exposure to other forms of energy.

The requirements specified by directive 89/336/EEC are as follows. CE compliance requires that the manufacturer or its authorized representative established within the Community affix the EC conformity mark to the apparatus or else to the packaging, instructions for use, or guarantee certificate. The EC conformity mark shall consist of the letters CE as specified and the figures of the year in which the mark was affixed. This mark should, where appropriate, be accompanied by the distinctive letters used by the notified body issuing the EC type-examination certificate. Where the apparatus is the subject of other Directives providing for the EC conformity mark, the affixing of the EC mark shall also indicate conformity with the relevant requirements of those other Directives.

UL¹ Compliance

The unit complies with Underwriters Laboratories (UL) standard 1950, the Standard for Safety Information Technology Equipment.

The unit complies with Underwriters Laboratories (UL) standard 3101.1, Electrical Equipment for Laboratory Use; Part 1: General Requirements.

¹ UL is a registered trademark of Underwriters Laboratories Inc.

General Information and Specifications

General Information

This user's manual for the HA9 Series Extended Range Programmable Optical Attenuator contains complete operating instructions.

The HA9 Series Extended Range Programmable Optical Attenuator (Figure 1) gives an extended attenuation range (100 dB) and high resolution (0.01 dB) for testing power meters and for general test and laboratory work. The linear design of the HA9 attenuator, combined with built-in calibration and offset functions, allows the user to match the display of the HA9 attenuator to an optical power meter over a wide power range. This combination is useful in tests requiring control of the absolute optical power into a test device. In addition, a built-in beam blocking switch allows fast access from any attenuation setting to infinite attenuation (blocking attenuation is >110 dB).



Figure 1: HA9 Series Extended Range Programmable Attenuator

The standard operating wavelength range of the HA9 attenuator is 1200 to 1700 nm. An optional wide wavelength range of 750 to 1700 nm with reduced attenuation range is available. Single-mode HA9 attenuators with an analog option are specifically designed for use in demanding applications, such as multichannel AM systems and high bit-rate digital pulse code modulation (PCM) systems.

The HA9 attenuator has an SCPI/HP 8156A compatible command set and can be controlled from either the front panel keypad or by parallel IEEE 488.1 or serial RS232 interfaces. LabVIEW² drivers are supplied to facilitate remote control. For information on using the LabVIEW drivers, see the *LabVIEW Instrument Driver for HA1, HA3, HA9, and HA11 Attenuators User's Manual* (document SD000322).

The optics of the HA9 attenuator are bidirectional and, therefore, either fiber port can be used as the input.

When the HA9 attenuator is used at high attenuation settings, the output fiber or cable must be shielded to prevent erroneous readings caused by ambient light pickup.

² LabVIEW is a registered trademark of National Instruments Corporation.

When combined with a light source, the attenuator can be used for EDFA testing or for calibrating the linearity of power meters. In addition, the attenuator can be used for loss simulation and for measuring bit error rate (BER) curves and the dynamic range of receivers (Figure 2).

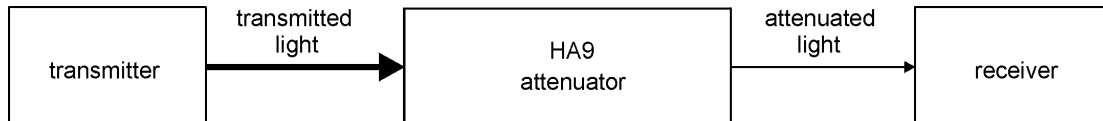

Figure 2: Block Diagram

Linearity

The linearity of the attenuation is not affected by wavelength.

Insertion Loss

Insertion loss is not included in the attenuation of the attenuator.

Source Considerations

Source output powers can be sensitive to reflections. For example, if the output of the attenuator is connected to a jumper with an unterminated, non-angled connector (for example, an FC/PC connector coupled into a detector), a large reflection can be coupled back into the source when the attenuator is used at low attenuation settings. Consequently, as the attenuation is increased, the reflection level back into the source decreases, making the HA9 attenuator seem non-linear over the range of 0 to 10 dB.

The following methods can be used to offset the effects of reflection:

- Using an angled connector (for example, an FC/APC connector) at the detector
- Adding some attenuation (5 to 10 dB typically) between the source and the attenuator
- Using an isolator between the source and the attenuator

Key Features

- 0.01 dB resolution and repeatability
- 0 to 100 dB attenuation range
- 1200 to 1700 nm or 750 to 1700 nm wavelength ranges
- Single-mode or multimode fiber
- Built-in beam blocking switch
- Less than 2.5 seconds from 0 to 100 dB
- IEEE 488.2 and RS232 interfaces
- SCPI compatible command set
- Universal connector adapter (UCA) option
- LabVIEW drivers

Applications

- Testing erbium doped fiber amplifiers (EDFAs)
- Testing and/or calibrating the linearity of power meters
- Measuring bit error rate curves
- Measuring the dynamic range of receivers
- Simulating loss

Standard Accessories

- LabVIEW drivers diskette and user's manual
- AC power cord
- Rack-mount kit with assembly instructions
- User's manual

Optional Accessories

- Built-in 1x2 switch
- Built-in splitter (1/99, 2/98, 5/95, 10/90, or 55/50)
- UCAs

Specifications

The following optical specifications describe the warranted characteristics of the unit (Table 2). Supplementary specifications describe the typical non-warranted performance of the unit (Table 3).

Table 2: Optical Specifications

Parameter	Standard	Wide
Wavelength range	1200 to 1700 nm	750 to 1700 nm
Attenuation range resolution repeatability ² change rate accuracy ³	100 dB 0.01 dB nominal ±0.005 typical, ±0.01 dB maximum ≤2.5 seconds, 0 to 100 dB ±0.03 dB typical, ±0.1 dB maximum	≥60 dB ¹ 0.01 dB nominal ±0.005 typical, ±0.01 dB maximum ≤2.5 seconds, 0 to 60 dB ±0.03 dB typical, ±0.1 dB maximum
Insertion loss ^{4,5} SM MM (50/125) MM (other)	1.2 dB typical, 1.5 dB maximum ≤2.2 dB ≤2.9 dB	≤5.0 dB ⁶ ≤3.2 dB ⁶ ≤3.9 dB ⁶
Return loss ^{1,2} SM SM (analog) MM (50/125) MM (other)		>45 dB >60 dB ⁷ >35 dB >30 dB
Maximum optical input power		200 mW
Polarization dependent loss ^{4,5}		0.03 dB typical, 0.08 dB maximum
Beam block attenuation		>110 dB
Beam block speed		<20 ms
Recalibration period (recommended)		2 years

¹ The attenuation range is a continuous function of wavelength.

² At constant temperature, wavelength, and polarization state after a half hour warm-up.

³ With optimization of the calibration wavelength or user slope. If optimization is not performed, accuracy is the greater of ±0.1 dB or ±0.004 dB/dB from 1260 to 1360 nm and from 1450 to 1570 nm. At other wavelengths, the accuracy is the greater of ±0.1 dB or ±0.015 dB/dB if optimization is not performed.

⁴ Measured at 23 °C with a laser source.

⁵ Not including connectors, switch, or coupler (if installed).

⁶ Over 850 to 1600 nm. Insertion loss is typically highest at wavelength extremes.

⁷ Total of discrete reflections, not including distributed reflection in fiber.

Table 3: Other Specifications

Electrical	
Input voltage	90 to 240 V AC, 50 to 60 Hz
Power consumption	80 VA maximum
Physical	
Dimensions (W x H x D) 19 inch (48.26 cm) rack mount	21.2 x 8.9 x 35.5 cm 2U high, ½ rack width, compatible with HP 8156A attenuator
Weight	4 kg
Environmental	
Operating temperature	0 to 40 °C
Storage temperature	-40 to 60 °C
Humidity	maximum 90% RH up to 40 °C, decreasing 5% per °C from 40 to 60 °C

Getting Started

The HA9 Series Extended Range Programmable Optical Attenuator consists of the attenuator unit, an AC power cord, rack-mount kit, and HA9 LabVIEW software.

Before Initializing and Operating the Unit

- Inspect the unit for any signs of damage.
- Read the user's manual thoroughly, and become familiar with all safety symbols and instructions to ensure that the unit is operated and maintained safely.

Initial Inspection

	<p>Warning</p> <p>To avoid electrical shock, do not initialize or operate the unit if it bears any sign of damage to any portion of its exterior surface, such as the outer cover or panels.</p>
---	---

Check that the unit and contents are complete:

1. Wear an anti-static wrist strap, and work in an electrostatic discharge (ESD) controlled area.
2. Inspect the shipping container for any indication of excessive shock to the contents, and inspect the contents to ensure that the shipment is complete.
3. Inspect the unit for structural damage that can have occurred during shipping.
4. Connect the unit to a power source, using the AC power cord provided.
5. Set the power switch to I (on), and observe the power-up sequence.

The attenuator always powers on in ATT mode. All key lamps and status LEDs light. The version number of the software is displayed briefly. The calibration wavelength in nm (XXXX), and the attenuation (YY.YY dB) are displayed, for example, XXXX YY.YY dB.

The command set (YYY), the message terminating sequence <CR> <LF>, or <CR> or <LF> (TR), and the GPIB address (AD; a number between 1 and 30) are also displayed. An example is YYY (TR) AD. The status of the beam block (BLK) and the attenuation in dB (XX.XX) are displayed, for example, BLK (XX.XX). If a malfunction is detected during the power-up sequence, an error message is displayed.

If an offset setting was entered and used before the last power-down, the OFFS status LED is lit, and the attenuation displayed is the offset value. If the offset value is 0, the attenuation displayed is 0.00 dB.

6. Keep the packaging.

Immediately inform JDS Uniphase and, if necessary, the carrier if the contents of the shipment are incomplete, if the unit or any of its components are damaged or defective, or if the unit does not pass the initial inspection.

Operating Environment

In order for the unit to meet the warranted specifications, the operating environment must meet the following conditions for temperature, humidity, and ventilation.

Temperature

The unit can be operated in the temperature range of 0 to 40 °C.

Humidity

The unit can be operated in environments with up to 90% humidity (0 to 40 °C). Do not expose it to any environmental conditions or changes to environmental conditions that can cause condensation to form inside the unit.

Ventilation

The unit contains a built-in cooling fan. Do not install it in any location where the ventilation is blocked. For optimum performance, the unit must be operated from a location that provides at least 75 mm (3 inches) of clearance at the rear and at least 25 mm (1 inch) of clearance at the bottom. Blocking the air circulation around the unit can cause the unit to overheat, compromising its reliability.

	<p>Warning</p> <ul style="list-style-type: none">• Do not use the unit outdoors.• To prevent potential fire or shock hazard, do not expose the unit to any source of excessive moisture.
---	--

Storing and Shipping

To maintain optimum operating reliability, do not store the unit in locations where the temperature falls below -40 °C or rises above 60 °C. Avoid any environmental condition that can result in internal condensation. Ensure that these temperature and humidity requirements can also be met whenever the unit is shipped.

Claims and Repackaging

Immediately inform JDS Uniphase and, if necessary, the carrier, if

- The contents of the shipment are incomplete
- The unit or any of its components are damaged or defective
- The unit does not pass the initial inspection

In the event of carrier responsibility, JDS Uniphase will allow for the repair or replacement of the unit while a claim against the carrier is being processed.

Returning Shipments to JDS Uniphase

JDS Uniphase only accepts returns for which an approved Return Material Authorization (RMA) has been issued by JDS Uniphase sales personnel. This number must be obtained prior to shipping any material to JDS Uniphase. The owner's name and address, the model number and full serial number of the unit, the RMA number, and an itemized statement of claimed defects must be included with the return material.

Ship return material in the original shipping container and packing material. If these are not available, packaging guidelines are as follows:

1. Wear an anti-static wrist strap and work in an ESD controlled area.
2. Cover the front panel, if applicable, with a strip of cardboard.
3. Wrap the unit in anti-static packaging. Use anti-static connector covers, if applicable.
4. Pack the unit in a reliable shipping container.
5. Use enough shock-absorbing material (10 to 15 cm or 4 to 6 in on all sides) to cushion the unit and prevent it from moving inside the container. Pink poly anti-static foam is the best material.
6. Seal the shipping container securely.
7. Clearly mark FRAGILE on its surface.
8. Always provide the model and serial number of the unit and, if necessary, the RMA number on any accompanying documentation.
9. Ship the unit only to the address given at the beginning of this document.

Cleaning Connectors

	<p>Caution</p> <ul style="list-style-type: none">• Connecting damaged or dirty fibers to the unit can damage the connectors on the unit.• Never force an optical connector. Some connectors have a ceramic ferrule that can easily be broken.
---	---

Optical cable ends need to be cleaned before using them with the unit.

The following items are required for cleaning:

- Filtered compressed air or dusting gas (for example, Tech Spray Envi-Ro-Tech Duster 1671 gas, available from <http://www.techspray.com/1671.htm>)
- Lint-free pipe cleaners (for example, from 3M³) or lint-free swab

³ 3M is a trademark of 3M.

- Lint-free towels (for example, 10 x 10 cm or 4 x 4 in HydroSorb III wipers, available from http://www.focenter.com/acctech/hydrosobr_wipers.htm)
- Optical grade isopropyl alcohol or optical grade 200° ethanol (do not use rubbing alcohol, which contains 30% water)

To clean the connectors:

1. Blow the sleeve with filtered compressed air (Figure 3).

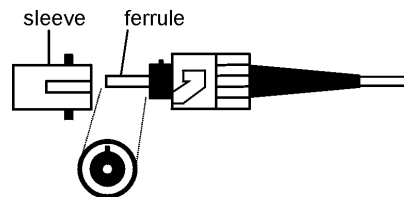

Figure 3: Connector Cleaning (connector type can vary)

2. Apply optical grade isopropyl alcohol or optical grade ethanol (do not use rubbing alcohol) to a small area of a lint-free towel and rub the end of the ferrule over the wet area.
3. Wipe the ferrule on a dry area of the lint-free towel.
4. Using the dusting gas or compressed air, blow the end of the ferrule.
5. Apply the alcohol or ethanol to a lint-free pipe cleaner or swab and wipe off the remaining parts of the connector.
6. With the other end of the pipe cleaner or swab, dry the areas cleaned.
7. Using the dusting gas or compressed air, blow the areas cleaned.

Connecting and Setting the GPIB Interface

The attenuator can be operated remotely using the GPIB interface. The 24-pin GPIB cable is user-supplied. When remote operation by the GPIB interface is required, first make the connection:

1. Check the GPIB cable to ensure that the pin assignment is correct (Figure 4).

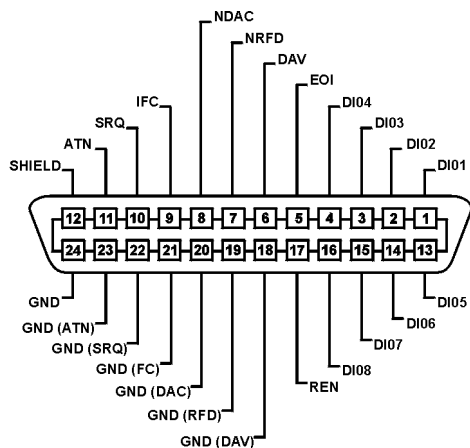



Figure 4: GPIB Pin Assignment

2. Connect the cable to the remote terminal and to the IEEE488 (GPIB) port at the back of the attenuator.

	<p>Caution</p> <p>Tighten the connector lock screws by hand. Do not use a screwdriver.</p>
---	---

Next, set or reset the GPIB address and the command set:

1. Ensure that the attenuator is powered off (O).
2. Turn on the power switch (I) and, while the unit powers on, press and hold the LCL key. The "GPIB setup" message is displayed. The previous mode, if any, is displayed, for example, SCPI(LF) 5. The command set HA9, HPM, or SCPI message-terminating sequence <CR> <LF>, <CR> or <LF> (TR), and the GPIB address are displayed, for example, SCPI (LF) 5. For the HA9 and HPM command sets, the message-terminating sequence is permanently set to <CR> <LF>.
3. Press the related ▲ / ▼ key to change the command set and the GPIB address.
4. Press the ATT/PWR key. Until manually reset, these settings are used each time the attenuator is powered up.

Connecting the RS232 Interface

The attenuator can be operated remotely using the RS232 interface. The nine-pin RS232 cable is user-supplied. When remote operation by the RS232 interface is required, make the connection:

1. Check the RS232 cable to ensure that the pin assignment is correct (Figure 5). Use a straight-through cable.

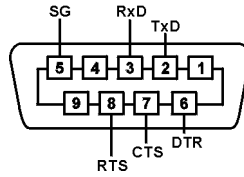

Figure 5: RS232C Pin Assignment

2. Connect the cable to the remote terminal and to the RS232C port at the back of the attenuator.

Driver Pin Assignment

The driver pin assignment is shown in Figure 6.

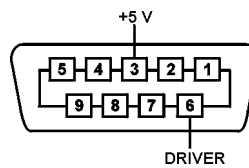

Figure 6: Driver Pin Assignment



Caution

Do not exceed 100 mA.

Checking Optional Connections

The attenuator can include an optional coupler or switch. If it does:

1. Ensure that the connections to the coupler or switch are appropriate.

Operating and Maintenance Instructions

Front Panel

The front of the attenuator is shown in Figure 7.

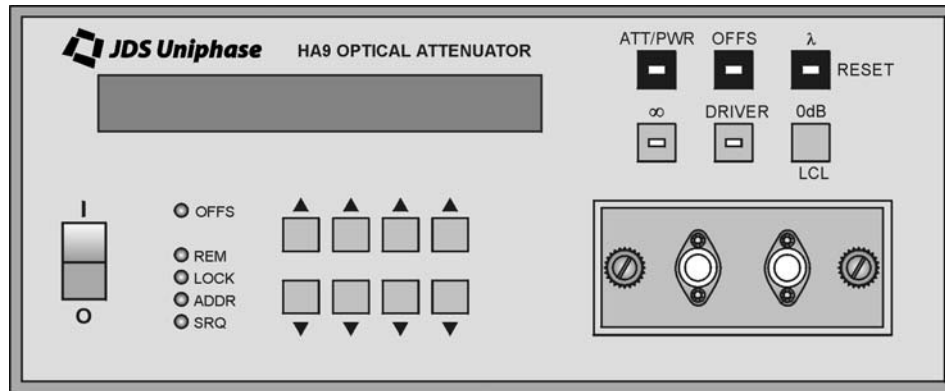

Figure 7: Front of the Attenuator (varies with model)

Operating Keys

The operating keys are described in Table 4.

Table 4: Operating Keys

Key	Description
I / O	Power on (I) /off (O) switch
ATT/PWR	Sets the unit to Attenuation (ATT) mode to display attenuation in dB or to Power (PWR) mode to display the optical power out in dBm
OFFS	Sets the unit to Display Offset mode. The ATT and PWR displays can be offset separately.
λ	Sets the unit to Calibration Wavelength mode
∞	Controls the on/off status of the beam block
DRIVER (reserved for future use) without built-in 1x2 switch with built-in 1x2 switch	Controls the on/off state of the driver Controls the switch state (off = Channel 1, on = Channel 2)
0 dB in ATT or PWR mode in Display Offset mode	Sets the attenuation to 0 dB Sets the offset to 0 dB
LCL	Returns the unit to Local mode from Remote mode

(table continued)

Key	Description
MIN	When held down for one second, sets the unit to the minimum loss position
▲ / ▼	Increases (▲)/decreases (▼) the attenuation, power offset, and wavelength calibration settings. Each pair controls a digit in the corresponding position displayed on the LCD (except for wavelength setting).

Status LEDs

The status LEDs are described in Table 5.

Table 5: Status LEDs

LED	Description
OFFS	Indicates that the unit is in Display Offset mode
REM	Indicates that the unit is in Remote mode. All the front-panel keys except LCL are locked out.
LOCK	Indicates that the unit is in Local Lockout mode. The function of the LCL key is disabled, and all front-panel keys are locked out.
ADDR	Indicates that the GPIB interface is in Talk or Listen state
SRQ	Indicates that the unit interrupt logic has generated a service request interrupt on the GPIB interface

Connector Panel

Two fiberoptic connectors, or cable feed-throughs, are mounted on a removable panel. The HA9 attenuator with a built-in splitter or switch has three fiberoptic connectors.

Rear Panel

The back of the attenuator is shown in Figure 8.

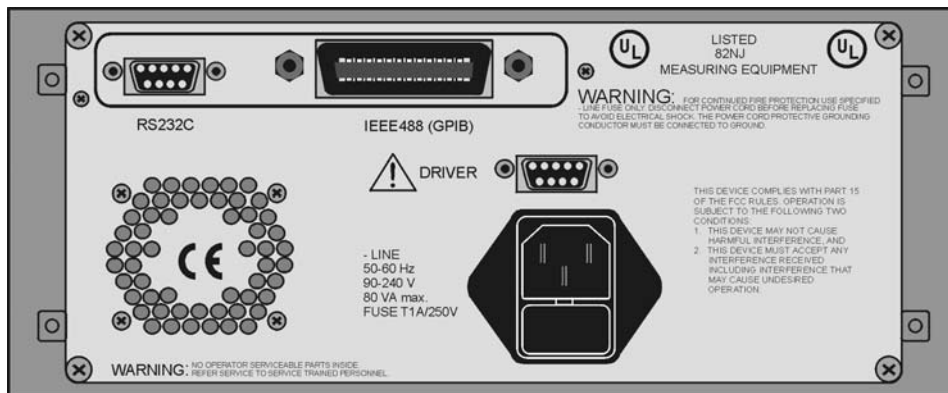

Figure 8: Back of the Attenuator

Setting Operating Mode and Using the Attenuator

The attenuator functions in Attenuation (ATT) mode or in output Power (PWR) mode.

In ATT mode, the attenuator displays attenuation in dB. Normally, the attenuation displayed on the front panel is relative to the 0 dB reference position of the attenuating optical filter inside the attenuator. However, the display-offset feature of the attenuator can be used to account for insertion and connection losses and the adjusted attenuation value displayed.

In PWR mode, the attenuator displays the optical output power in dBm. The attenuator has no power measurement capability; but using the calibration methods described in **Setting the Calibration Wavelength** and **Setting the User Slope** sections, the user can match the power level displayed by the attenuator to an external power meter.

To power up the unit:

1. Connect the attenuator to the AC power source, using the AC power cord provided.
2. Set the power switch to **I** (on), and observe the power-up sequence. The attenuator always powers on in ATT mode. All key lamps and status LEDs light. The version number of the software is displayed briefly. The calibration wavelength in nm (XXXX), and the attenuation (YY.YY dB) are displayed, for example, XXXX YY.YY dB.

The command set (YYY), the message terminating sequence <CR> <LF>, or <CR> or <LF> (TR), and the GPIB address (AD; a number between 1 and 30) are also displayed. An example is YYY (TR) AD. The status of the beam block (BLK) and the attenuation in dB (XX.XX) are displayed, for example, BLK (XX.XX). If a malfunction is detected, an error message is displayed.

If an offset setting was entered and used before the last power-down, the OFFS status LED is lit, and the attenuation displayed is the offset value. If the offset value is 0, the attenuation displayed is 0.00 dB.

To set the operating mode to ATT or PWR mode:

1. Press the ATT/PWR key to toggle between Attenuation and Power modes. When switching back from OFFS or λ (wavelength) mode, the last operating mode used (ATT or PWR) is activated when ATT/PWR is pressed. The attenuator displays results in dB when in ATT mode and in dBm when in PWR mode.

To use the attenuator:

1. Connect the device under test to the unit (Figure 9).

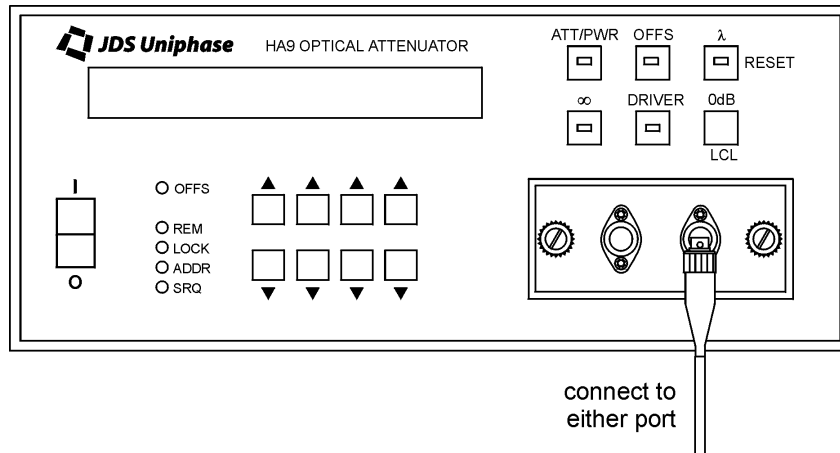

Figure 9: Using the Attenuator

Turning the Beam Block On or Off

The beam block function uses a transistor to drive a 5 V relay which, when activated, moves a blocking element in front of the light beam. The relay actuator is attached to the beam-blocking element, which provides an infinite attenuation by blocking the optical path.

The built-in beam block is automatically activated when the attenuator is powered off, as a safety feature. It must be deactivated after power-up so that light can pass through the attenuator. To turn the beam block on or off when the attenuator is powered on:

1. To turn the beam block off, press the ∞ key. The beam block is deactivated when the indicator light on the ∞ key is on (the beam block moves out of the beam, thereby turning on the optical power from the attenuator).
2. To turn the beam block on, press the ∞ key. The beam block is activated when the indicator light on the ∞ key is off (the beam block remains in the beam, thereby turning off the optical power from the attenuator).

Setting the Calibration Wavelength

Set the calibration wavelength before setting the display offset and the attenuation. For accurate output from the attenuator, set the wavelength on the attenuator to match the source wavelength.

To calibrate the attenuator for a specific source wavelength:

1. Press the λ key. The key lamp lights. The attenuation or power setting (YY.YY) and the calibration wavelength (XXXX nm) are displayed, for example, YY.YY / XXXX nm.
2. Press the \blacktriangle or \blacktriangledown key to adjust the calibration wavelength to the required resolution of 1 nm. A change in the calibration wavelength automatically changes the attenuation or power setting displayed by the attenuator.

3. When the required wavelength setting is reached, press ATT/PWR to store the setting and return to the attenuation or power display.

A correction factor curve is adjusted for each attenuator to provide optimum performance with a laser diode source at 1300 and 1550 nm. The user can increase or decrease the calibration wavelength of the HA9 attenuator to find a better slope correction factor for the source in use.

The attenuator is optimized for low insertion loss at both 1300 and 1550 nm. Typically, the variation in insertion loss from 1200 to 1700 nm is ≤ 0.2 dB.

Setting the User Slope

The slope of the attenuator can be matched to a power meter for a given source by optimizing the calibration wavelength or by storing a user slope. Both procedures can be performed locally or remotely.

Set the user slope before setting the display offset and the attenuation.

Optimizing the Calibration Wavelength

To optimize the calibration wavelength:

1. Press and hold the λ key for three seconds. The HA9 attenuator is reset, that is, the attenuation is set to 0 dB, the operating mode is set to ATT, and the display offset is set to 0 dB.
2. Set the power meter to 0 dB.
3. Press the \blacktriangle or \blacktriangledown key to set the attenuation to 10 dB.
4. Press the λ key.
5. Press the \blacktriangle or \blacktriangledown key to set the calibration wavelength to the source wavelength, increasing or decreasing the calibration wavelength until the attenuation displayed on the front panel of the attenuator matches the power meter reading.

The attenuation on the HA9 attenuator can be set higher than 10 dB, provided that the power meter remains linear. Attenuation settings lower than 10 dB are not recommended.

Storing a User Slope

To store a user slope:

1. Press and hold the λ key for three seconds. The attenuator is reset, that is, the attenuation is set to 0 dB, the operating mode is set to ATT, and the display offset is set to 0 dB.
2. Set the power meter to 0 dB.
3. Press the \blacktriangle or \blacktriangledown key to adjust the attenuation until the power meter reading reaches 10.00 dB.

4. Press the λ key.
5. Press the 0 dB key. The calibration wavelength changes to “user”, and the displayed attenuation changes to 10.00 dB.
6. To cancel the user slope, reset the attenuator or switch to λ mode, and then press the corresponding \blacktriangle or \blacktriangledown key.

Setting the Display Offset

The attenuator uses separate display offsets for ATT and PWR mode. The minimum offset level is 0 dB and the maximum is 99.99 dB.

Setting the Display Offset in ATT Mode

In Attenuation mode, the display offset is used to include both the insertion loss of the attenuator and any connection losses in the attenuation value displayed.

To set the offset:

1. Ensure that the attenuator is in ATT mode (readings are in dB). (If not in ATT mode, press the ATT/PWR key.) The attenuator displays the offset (OFFS) that is added to (or subtracted from) the actual attenuation (XX.XX), for example, OFFS XX.XX dB. The offset value is displayed to two decimal places.
2. Press the OFFS key. The key lamp lights to indicate that the attenuator is ready to read the offset value.
3. Press the 0 dB key to set the display offset to 0 dB.
4. To use an offset other than 0 dB, press the \blacktriangle or \blacktriangledown key to adjust the setting. The OFFS status LED lights.

Setting the Display Offset in PWR Mode

In Power mode, the display offset is used to match the power displayed by the attenuator to a power meter reading in dBm.

To set the offset:

1. Ensure that the attenuator is in PWR mode (the display is in dBm). (If not in Power mode, press the ATT/PWR key.) The attenuator displays the output power including the offset, for example, DISP XX.XX dBm.
2. Press the OFFS key. The key lamp lights to indicate that the attenuator is ready to read the offset value.
3. Press the 0 dB key to set the display offset to 0 dB.
4. To use an offset other than 0 dB, press the \blacktriangle or \blacktriangledown key to adjust the setting. The OFFS status LED lights.

Setting the Power

The attenuator has no internal power measurement capability, but by using the display-offset feature of the attenuator, the display can be matched with the help of an external power meter.

To set the power:

1. Ensure that the attenuator is set to PWR mode (the display is in dBm).
2. Press the ▲ or ▼ key to adjust the output power.
3. Ensure that the source power and connection losses are stable during the calibration procedures and subsequent device testing.

Controlling the Driver

If the HA9 attenuator is equipped with a 1x2 switch, the DRIVER key controls the switch state, for example, off = Channel 1, on = Channel 2.

1. To activate the driver, press the DRIVER key. The key lamp lights.
2. To deactivate the driver, press the DRIVER key. The key lamp turns off.

Resetting the Attenuator

To reset the attenuator:

1. Press the λ key and hold it for three seconds. The attenuator is reset to the following configuration:

wavelength	= 1310 nm
attenuation	= 0 dB
mode	= ATT
display offset	= 0 dB

If the reset procedure fails, the attenuator displays an error message.

Checking Attenuator Calibration

The attenuator is factory-calibrated, but wavelength calibration and insertion loss can be verified.

Required Equipment

The following equipment is required:

- Light source for the wavelength at which the calibration is being verified, for example, a 1550 nm source for calibration verification at 1550 nm. (Record the exact peak center wavelength of the source for future reference.)
- Power meter that is accurate up to at least -90 dBm and has a resolution of at least 0.1 dB
- Appropriate jumpers (FC/PC or FC/APC, as required)

- Various connectors
- Isolator (optional)

Verifying Calibration

To verify calibration:

1. With the attenuator powered off (O), clean all optical connections before each connection with an alcohol-soaked swab. See the **Cleaning Connectors** section.
2. To avoid reflection-induced source power changes, ensure that the connector to the power meter has low reflection or that the source has an isolator.
3. Zero the power meter.
5. Connect the source to the attenuator, and connect the attenuator to the power meter (Figure 10).

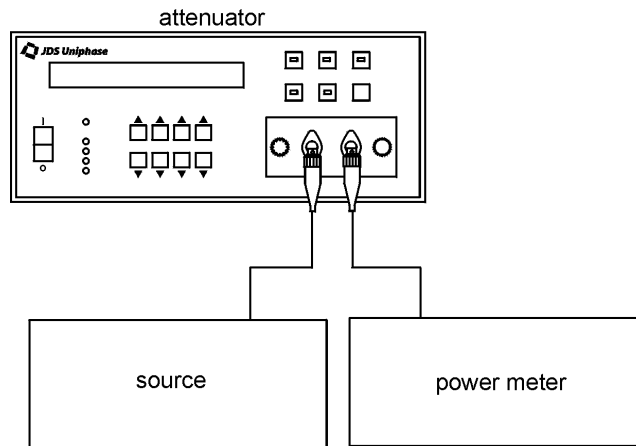

Figure 10: Wavelength Verification Setup

6. Set the power switch on the attenuator to **I** (on), and verify that both the attenuator and the power meter are set to the same wavelength as the source. Ensure that the ∞ key LED is off.
7. Set the attenuator to zero, and record the value displayed on the power meter.
8. Increase the attenuation in 1 dB steps until the attenuator reads 90 dB. After each step, record the value displayed on the attenuator and the value displayed on the power meter.
9. Apply the following formula to each reading:
$$(\text{attenuator reading} - 0) - (\text{power reading} - \text{power reading with the attenuator set to } 0)$$
10. If the resulting data indicates that the attenuator is no longer operating within the specifications stated in the **Specifications** section, return the attenuator to the factory for recalibration. Recalibration is recommended every two years.

Verifying Insertion Loss

To verify insertion loss:

1. Zero the power meter.
2. Connect the source directly to the power meter by bypassing the attenuator and connecting the two jumpers or pigtails together (Figure 11).

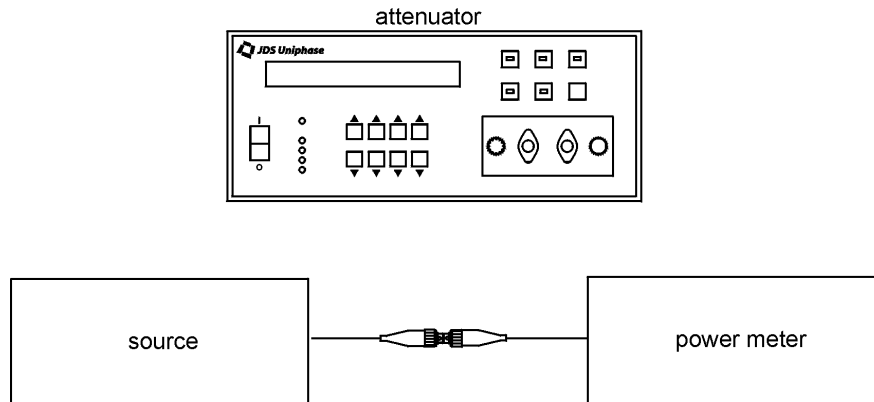

Figure 11: Insertion Loss Verification Setup

3. Record the value displayed on the power meter.
4. Connect the source to the attenuator, and connect the attenuator to the power meter (Figure 10).
5. Set the attenuator to 0 dB.
6. Record the value displayed on the power meter. The difference between this reading and the reading taken in step 3 is the insertion loss.

If the resulting data indicates that the attenuator is no longer operating within the specifications stated in the **Specifications** section, return the attenuator to the factory for recalibration. Recalibration is recommended every two years.

Maintaining the Attenuator

Clean the connector ends with a lint-free tissue and alcohol before every mating. See the **Cleaning Connectors** section.

Also clean the connectors inside the unit:

1. Loosen the retaining screws of the connector panel.
2. Pull the panel out carefully, extending it no more than 10 cm (4 in) from the body of the attenuator (Figure 12).

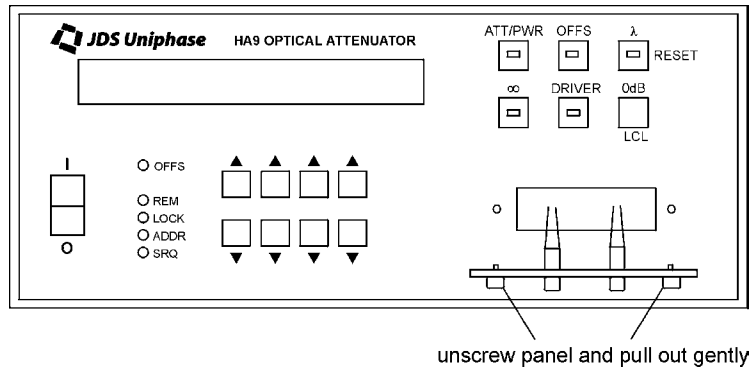

Figure 12: Removing the Connector Panel

3. Remove the connectors from the connector bulkheads.
4. Clean the connector ends and the bulkhead mating sleeves with a lint-free tissue and alcohol.
5. Reinstall the connectors into the connector bulkheads.
6. Reinstall the connector panel, guiding the fibers back to ensure that they do not bend sharply.

Programming Guide

The following programming instructions for the HA9 attenuator are intended for users who are familiar with remote interfaces and how to send or receive messages over a device.

A detailed description of the GPIB interface is in *ANSI/IEEE Std. 488.1-1987 IEEE Standard Digital Interface for Programmable Instrumentation* published by the Institute of Electrical and Electronics Engineers.

There are two external interfaces for remote control of the attenuator: a GPIB parallel interface and an RS232 serial interface. Either interface can be used to send commands and receive status information from the attenuator while using the SCPI or HA command set. (HP Mode operation is not available via the RS232 interface.)

The attenuator accepts three types of command sets: HPM (for example, HP Mode), Standard Command for Programmable Instrument (SCPI), and HA9.

The HPM command sets are provided for compatibility with previous attenuator models. The HPM command sets are compatible with the Hewlett Packard HP 8157A and HP 8156B attenuators.

The SCPI command set is based on IEEE 488.2 and is compatible with the Hewlett Packard HP 8156A attenuator.

On power up, the attenuator displays the active interface command set.

Setting the GPIB Address and the Interface Command Set for Remote Operation

Before using the attenuator in Remote mode, the GPIB address and the instrument command set must be selected. The GPIB address is a number between 1 and 30 and is used to select an instrument on the GPIB bus. The command set is HPM, SCPI, or HA. To set the attenuator for remote GPIB operation:

1. Ensure that the attenuator is powered off (O).
2. Set the power switch to I (on) and as the unit powers on press and hold the LCL key for a few seconds. The display shows the command set [SCPI, HA9, or HPM (YYY)], the message terminating sequence [carriage return, line feed <CR> <LF> or <LF> (TR)], and the GPIB address [AD, for example, YYY (TR) AD].
3. Press the ▲ or ▼ key to change the GPIB address and the command set.
4. Press the ATT/PWR key.

Until reset, the settings are recalled by the attenuator on power-up.

In the HA9 and HPM command sets, the message terminating sequence is permanently set to <CR> <LF>.

In SCPI mode, the message terminating sequence is automatically set to <LF>.

Switching between Remote and Local Operation

The attenuator is automatically placed in Remote mode as soon as a computer communicates with the attenuator via the GPIB or RS232 port using the SCPI or HA command set.

The REM status LED lights to indicate that the attenuator has transitioned to Remote mode and can accept commands from the GPIB or RS232 port, and that all front panel keys except LCL are locked out. The LCL key remains active to return the control back to front panel keys.

To exit Remote mode and return to Local mode:

1. Press the LCL key. (The LCL key is disabled if the attenuator has been set to Local Lockout mode.) The REM LED is lit when the attenuator is in Remote mode.

GPIB Interface Functions

The functions are listed in Table 6.

Table 6: GPIB Functions

Mnemonic	IEEE 488.2 Function
SH1	source handshake, complete capability
AH1	acceptor handshake, complete capability
T6	basic talker, serial poll, unaddressed if MLA
L4	basic listener, unaddressed if MTA
SR1	service request capability
RL1	remote/local, complete capability
PP0	parallel poll, no capability
DC1	device clear, complete capability
DT0	device trigger, no capability
C0	controller, no capability
E1	electrical interface, open collector drivers

RS232 Interface Functions

The functions are listed in Table 7.

Table 7: RS232 Functions

Name	Symbol	Pin Number	Signal Direction
transmitted data	TxD	2	out
received data	RxD	3	in
request to send	RTS	8	out
clear to send	CTS	7	in
data terminal ready	DTR	6	out
signal ground	SG	5	—

The data protocol is permanently set to 1200 baud, ASCII character code with eight bits per character, one stop bit, and no parity bit. The serial port of the controlling computer must be configured with the same settings.

RS232 Programming Examples

This section provides programming examples for controlling the attenuator over the RS232 interface. The examples were written in MS-DOS⁴ Qbasic and run on a personal computer equipped with a serial port. COM port 2 of the computer must be designated as the serial port and must be connected to the attenuator.

Before using any of these examples, ensure that the active interface command set is HA9.

The RS232 interface cannot receive an SRQ interrupt.

The RS232 commands that appear in this section do not always show the terminating sequence; however, it is implied.

Sending Commands

This example sets the wavelength to 1300 nm and the attenuation to 20 dB. These commands demonstrate the use of a variable in the statement that sends the attenuation command.

```
OPEN "COM2:1200,N,8,1" FOR RANDOM AS #3
PRINT#3, "WVL 1300e-9 m"
atten=20
PRINT#3, "ATT ";atten;" dB"
END
```

⁴ MS-DOS is a registered trademark of Microsoft Corporation.

Querying Status

This example queries and displays the current attenuation setting.

```
OPEN "COM2:1200,N,8,1" FOR RANDOM AS #3
PRINT#3, "ATT?"
INPUT#3, A
PRINT A
END
```

Reading the Status Register

The serial polling function is not supported on any RS232C interface, but the **STB?** command can be used to query the status register because it performs the same function as serial polling.

This example changes the attenuation setting and reads the status register continuously until the output has settled.

```
OPEN "COM2:1200,N,8,1" FOR RANDOM AS #3
PRINT#3, "CSB"                                ' clear status register
PRINT#3, "ATT 40"
DO                                             ' loop until motor settles
    PRINT#3, "STB?"
    INPUT#3, SR1
LOOP UNTIL (SR1 AND 4 = 4)
PRINT SR1
END
```

Learn Query (LRN?)

This example demonstrates the use of the query **Learn**.

```
OPEN "COM2:1200,N,8,1" FOR RANDOM AS #3
PRINT#3, "LRN?"
INPUT#3, fiber,block,srq_mask,cal,atten,wave
' The above variables can be saved in a data file before quitting the program and then later
' read back and used to restore the attenuator to the same state in ATT mode
' like this....

PRINT#3, "WVL ";wave;"CAL ";cal;"ATT ";atten;"D ";block
' Attenuation mode settings are now restored
END
```

HA9 and HPM Command Sets

Remote control, operation, and query commands to the attenuator can be sent via the GPIB or the RS232 interface.

Command Parser Rules

- Commands consist of a mnemonic (for example, **WVL**) and, if required, a data parameter (for example, **1300NM**). The mnemonic and the parameter must be separated by at least one space.
- Parameters can be entered in various formats. For example, **1300nm**, **1.303-6 mm**, and **0.0000013M** are recognized as the same value.
- Commands can be sent in uppercase or lowercase characters.
- A command is contained in a message, and messages can contain more than one command, each one separated by a semicolon (;). For example, **WVL 1300NM; CAL 10dB; ATT 50 dB <CR> <LF>** contains three commands.
- All GPIB commands must end with the terminating sequence **<CR> <LF>** if the active interface command set is HA9 or HPM.
- All RS232 commands must end with the terminating sequence **<CR>**.
- The input buffer of the attenuator can hold as many as 100 characters. If the buffer becomes full, the attenuator holds the handshaking line on the GPIB interface until space is available. Similarly, over the RS232 interface, the attenuator sets the Clear-To-Send line low. Any characters received after the line goes low are ignored.
- Commands are executed as they are parsed; consequently, a command can be executed before the entire message in which it is contained is received.
- The attenuator delays accepting new characters sent over the GPIB interface while the attenuator mechanism is moving, but no data are lost. The attenuator does not complete the data exchange handshaking on the bus until the new attenuation is set.

The attenuator is always ready to accept characters over the RS232 interface.

- A query command is used to extract status information from the attenuator. For example, **ATT? <CR> <LF>** returns the current attenuation setting.
- The queries **ATT?**, **PWR?**, **CAL?**, **PCAL?**, and **WVL?** can include the parameters **MIN** and **MAX**. **ATT? MAX**, for example, returns the maximum attenuation that can be set at the current wavelength.
- Query commands in remote operation of the attenuator (via the GPIB or the RS232 interface) results in four digits after the decimal point. However, only the first two digits after the decimal point are significant; the third and fourth decimal digit must be ignored.
- Multiple-command messages can contain only one query command. A query must be the last command in the message, for example, **ATT 20 dB; ATT? <CR> <LF>**.

HA9/HPM Operation Commands

D

Beam Block

Controls the on/off status of the beam block:

- 0 = beam block off
- 1 = beam block on

RESET

Reset

Returns the attenuator to the following default settings:

- WVL = 1310 nm
- DISP = 0
- CAL = 0 dB
- PCAL = 0 dB
- ATT = 0 dB

The values of D, XDR, and SRE are not changed.

WVL

Calibration Wavelength

Sets the calibration wavelength of the attenuator from 1200 to 1700 nm for the standard HA9 model and from 750 to 1700 nm for the wide model (HA9W). The default unit is meters (m).

DISP

Display Mode

Controls the display mode of the attenuator while in Remote mode:

- 0 = ATT mode
- 1 = PWR mode

CAL

Display Offset (ATT Mode)

Sets the display offset in ATT mode. The default unit is dB.

PCAL

Display Offset (PWR Mode)

Sets the display offset in PWR mode. The default unit is dBm.

STPWR**Display Offset (PWR Mode)**

Sets the display offset in PWR mode so that the display matches the power meter reading. The default unit is dBm.

ATT**Attenuation**

Sets the attenuation of the attenuator relative to the 0 dB reference position; that is, it is independent of the attenuation display offset. The default unit is dB.

PWR**Output Power**

Sets the output power of the attenuator, including the display offset. The default unit is dBm.

Use PCAL or STPWR or perform a calibration in Local mode before performing PWR.

XDR**Driver Control**

Controls the on/off status of the driver:

- 0 = driver off
- 1 = driver on

SRE**SRQ Mask Register**

Writes a decimal number to the eight-bit SRQ mask register. Setting a bit to 1 generates a service request interrupt (SRQ) when the corresponding bit in the status register changes from 0 to 1 (see the **Status Reporting and Service Request Control** section).

CSB**Clear Status Byte**

Clears or resets the status byte.

CLR**Clear SRQ Mask Register**

Clears the SRQ mask register (see the **Status Reporting and Service Request Control** section).

F

This command is inactive and serves only to maintain the compatibility of the attenuator to the HP 8157A attenuator.

HA9/HPM Query Commands

D?

Beam Block Status

Returns the on/off status of the beam block:

- 0 = beam block off
- 1 = beam block on

WVL?

Calibration Wavelength

Returns the calibration wavelength:

- **WVL?** returns the current calibration wavelength
- **WVL? MIN** returns the minimum calibration wavelength
- **WVL? MAX** returns the maximum calibration wavelength

SLP?

Slope User Value

Returns the user slope:

- **SLP?** returns the current user slope
- **SLP? MIN** returns the minimum user slope
- **SLP? MAX** return the maximum user slope

USER?

Slope Control

Returns the method by which the attenuator determines the slope of the attenuation:

- 0 = calibration wavelength
- 1 = user slope

DISP?

Display Mode

Returns the display mode of the attenuator:

- 0 = ATT mode
- 1 = PWR mode

CAL?

Display Offset (ATT Mode)

Returns the display offset in ATT mode:

- **CAL?** returns the current display offset
- **CAL? MIN** returns the minimum display offset
- **CAL? MAX** returns the maximum display offset

PCAL?

Display Offset (PWR Mode)

Returns the display offset in PWR mode:

- **PCAL?** returns the current display offset
- **PCAL? MIN** returns the minimum display offset
- **PCAL? MAX** returns the maximum display offset

PWR?

Power Setting

Returns the optical power setting:

- **PWR?** returns the current optical power setting
- **PWR? MIN** returns the minimum optical power setting at the current wavelength
- **PWR? MAX** returns the maximum optical power setting at the current wavelength

If the HA9 attenuator is set at the minimum loss position, **PWR?** returns 101 dB.

ATT?

Attenuation

Returns the attenuation of the attenuator:

- **ATT?** returns the current attenuation
- **ATT? MIN** returns 0 or the minimum attenuation setting at the current wavelength
- **ATT? MAX** returns 0 or the maximum attenuation setting at the current wavelength

If the HA9 attenuator is set at the minimum loss position, **ATT?** returns -1 dB.

XDR?

Driver Status

Returns the status of the driver:

- 0 = driver is off
- 1 = driver is on

SRE?**Status Register**

Returns the contents of the status register as an integer.

CNB?**Condition Register**

Returns the contents of the condition register as an integer (see the **Status Reporting and Service Request Control** section).

TST?**Self-test**

Executes a self-test operation and returns the result. An error code is also placed into the error queue. The queue can be queried with **ERR?** or **LERR?**. **TST?** also sets bit 7 in the status register.

- 0 = self-test passed
- 1 = self-test failed

ERR?**Error Number**

Returns an error number if the self-test operation fails:

- 330 = self-test failed
- 0 = no error occurred

LERR?**Last Error**

Returns an error number from an error queue. The queue can contain as many as five error numbers. The first error read is the last error that occurred.

- 000 = error queue is empty

OPC?**Input Buffer**

Returns the status of the input buffer:

- 1 = the input buffer is empty; for example, all commands have been executed
- 0 = the input buffer is not empty; for example, commands are still pending

IDN?**Identification**

Returns a string that identifies the manufacturer, the HA9 model number, the serial number (or 0 if unavailable), and the firmware level, for example, JDS UNIPHASE HA9x,01, 0,00.100 (where x = S for standard model and x = L for wide model).

F?

Always returns 1. This command serves only to maintain the compatibility of the attenuator to the HP 8157A attenuator.

LRN?

Learn

In HA and HP mode, returns a 58-character string containing a summary of the current settings of the attenuator. The string is formatted as follows:

- Fiber setting = four characters (always returns 1)
- Output state = four characters (0 = beam block off, 1 = beam block on)
- SRQ mask = eight characters
- Attenuation display offset = 13 characters
- Attenuation = 13 characters
- Wavelength = 16 characters

HA mode example: 1 0 6 10.0000 22.0000 13000e-06

HP mode example: F I;D 1;SRE 6;CAL 10.0000;ATT 22.0000;WVL 13000e-06;

Status Reporting and Service Request Control

The attenuator maintains three eight-bit registers that are used for status reporting and enabling the GPIB service request interrupt:

- Condition register
- Status register
- SRQ mask register

Condition Register

The condition register monitors the current state of the attenuator mechanism. Bit 2 is set to 1 when the attenuation is constant and to 0 when the attenuator mechanism is moving to a new setting. The query **CNB?** returns the value of the condition register. When bit 2 is 1, **CNB?** returns 4.

Condition Register							
Bit 7	Bit 6	Bit 5	Bit 4	Bit 3	Bit 2	Bit 1	Bit 0
0	0	0	0	0	settled	0	0

Status Register

The status register records errors and other events that have occurred in the attenuator. When an event occurs, the attenuator status logic sets the corresponding bit. The status register can be read at any time because the bits stay set until the register is read at least once.

Status Register							
Bit 7	Bit 6	Bit 5	Bit 4	Bit 3	Bit 2	Bit 1	Bit 0
self-test error	service request	syntax error	message available	0	settled	0	parameter error

- Bit 7 (self-test error) is set if a calibration error was detected after power-up or after the self-test query (**TST?**) was executed. At all other times it is 0.
- Bit 6 (service request) is set when the interrupt request logic of the attenuator detects a reason to generate an SRQ on the GPIB.
- Bit 5 (syntax error) is set when the parser detects a syntax error in a command mnemonic.
- Bit 4 (message available) is set when a message is available in the output buffer.
- Bit 2 (settled) is set when bit 2 in the condition register changes from 0 to 1.
- Bit 0 (parameter error) is set when a parameter value is out of the range of the attenuator.

The status register can be read with the status register query (**STB?**) or by serial polling the GPIB interface. During power-up, the status register contains 0 and can be read only by serial polling. After initial power-up, only bit 2 is set to 1. The clear status byte command (**CSB**) and the clear device command (**CLR**) clear the status register.

STB? can be used to clear the status register only if bit 6 is on.

SRQ Mask Register

The SRQ mask register unmask specific events in the status register that generate a service request interrupt on the GPIB interface. The SRQ mask command (**SRE**) writes to the SRQ mask register. When a bit in the SRQ mask register is set to 1, the interrupt logic of the attenuator monitors the corresponding event bit in the status register. When the bit changes from 0 to 1, a service request interrupt is generated and bit 6 in the status register is set.

The SRQ mask register can unmask more than one event at a time. The first unmasked event to change from 0 to 1 causes an interrupt. To acknowledge this interrupt, the GPIB interface can be serial polled or the status register can be read with **STB?**. The first time the attenuator is serial polled after an SRQ is generated, bit 6 is on. Subsequent serial polling returns a value with bit 6 off. Similarly, **STB?** returns the status register with the SRQ set, but then the attenuator logic automatically clears the register. As a result, subsequent **STB?** queries return 0.

The SRQ mask register is cleared by powering up the attenuator, by the **CLR** command, or by the universal device clear command (**DC1**).

SRQ Mask Register							
Bit 7	Bit 6	Bit 5	Bit 4	Bit 3	Bit 2	Bit 1	Bit 0
self-test error	n/a	syntax error	message available	n/a	settled	n/a	parameter error

GPIB Programming Examples

This section provides programming examples for controlling the attenuator over the GPIB interface. The examples were written in MS-DOS Qbasic and run on a personal computer, equipped with a National Instruments⁵ GPIB interface board with National Instruments Universal Language Interface drivers loaded. The commands that control the GPIB are similar to Hewlett Packard HP Basic commands. Most other controller board manufacturers provide basic output and input statements for communicating messages to a GPIB instrument.

Before using any of these examples, ensure that the GPIB address is set to 5, that the active interface command set is HA9, and that the switch is connected to the computer via a GPIB cable.

The GPIB commands that appear in this section do not always show a terminating sequence; however, it is implied.

Sending Commands

This example sets the wavelength to 1300 nm and the attenuation to 20 dB; the commands demonstrate the use of a variable in the statement that sends the attenuation command:

```
OPEN "GPIB0" FOR OUTPUT AS #1
OPEN "GPIB0" FOR INPUT AS #2
PRINT #1, "ABORT"
PRINT#1, "GPIBEOS IN CR LF"
PRINT#1, "GPIBEOS OUT CR LF"

PRINT #1, "OUTPUT 05;WVL 1300e-9 m"
atten = 20
PRINT #1, "OUTPUT 05;ATT ";atten; " dB"
END
```

This example sets the offset to 10, the total attenuation to 30 dB, and the wavelength to 1550 nm:

```
OPEN "GPIB0" FOR OUTPUT AS #1
OPEN "GPIB0" FOR INPUT AS #2
PRINT #1, "ABORT"
```

⁵ National Instruments is a trademark of National Instruments.

```

PRINT #1, "RESET"
PRINT #1, "GPIBEOS IN LF"
PRINT #1, "GPIBEOS OUT LF"

```

' setting terminating characters to LF

```

DIM ATTEN AS SINGLE
DIM WAV AS INTEGER

```

```

PRINT #1, "OUTPUT 05;:INP:OFFS 10"
ATTEN = 30.0
WAV = 1550
PRINT #1, "OUTPUT 05;:INP:ATT";STR$(ATTEN);";WAV";STR$(WAV);"NM"
END

```

Querying Status

This example queries and displays the current attenuation setting:

```

OPEN "GPIB0" FOR OUTPUT AS #1
OPEN "GPIB0" FOR INPUT AS #2
PRINT #1, "ABORT"
PRINT#1, "GPIBEOS IN CR LF"
PRINT#1, "GPIBEOS OUT CR LF"

```

```

PRINT #1, "OUTPUT 05;ATT?"
PRINT #1, "ENTER 05"
INPUT #2, A
PRINT A
END

```

Serial Polling the Status Register

This example changes the attenuation setting and reads the status register continuously until the output has settled:

```

OPEN "GPIB0" FOR OUTPUT AS #1
OPEN "GPIB0" FOR INPUT AS #2
PRINT #1, "ABORT"
PRINT#1, "GPIBEOS IN CR LF"
PRINT#1, "GPIBEOS OUT CR LF"

```

```

PRINT #1, "OUTPUT 05;CSB"
PRINT #1, "OUTPUT 05;ATT 0.3456e2"
sr = 0
DO
  PRINT #1, "SPOLL 05"
  INPUT #2, sr
LOOP UNTIL (SR AND 4 = 4)
PRINT sr
END

```

' clearing the status byte clears the settling bit

' change the attenuation to 34.56 dB

' initialize sr variable to enter the while loop

' loop until settled bit is true

' serial poll the attenuator

' print final value of sr

Generating a Service Request Interrupt

A service request interrupt is generated when the attenuator completes changing the attenuation setting. This example tests the service request interrupt function. It unmask the settled bit in the SRQ mask register and sends a new attenuation setting.

```
OPEN "GPIB0" FOR OUTPUT AS #1
OPEN "GPIB0" FOR INPUT AS #2
PRINT #1, "ABORT"
PRINT#1, "GPIBEOS IN CR LF"
PRINT#1, "GPIBEOS OUT CR LF"

ON PEN GOSUB SPOLL           'enable SRQ interrupt
PEN ON
PRINT #1, "OUTPUT 05;CSB;SRE 4" ' clear status register and unmask
                                ' settled bit in SRQ mask register
PRINT #1 "OUTPUT 05;ATT 45"    ' change attenuation setting
' More code executed while attenuation set
'
WHILE (INKEY$ = "")           ' endless loop to simulate bigger program
WEND                          ' ends when any key is pressed
PEN OFF
END

SPOLL:
  PRINT #1, "SPOLL 05"        ' serial poll the attenuator
  INPUT #2, sr                ' read status register
  PRINT sr                    ' verify SRQ bit is set
  PRINT #1, "SPOLL 05"        ' serial poll again to verify SRQ bit is now cleared
  INPUT #2, sr                ' read status register
  PRINT sr
RETURN
```

Learn Query (LRN?)

This example demonstrates the use of the **Learn** query:

```
OPEN "GPIB0" FOR OUTPUT AS #1
OPEN "GPIB0" FOR INPUT AS #2
PRINT #1, "ABORT"
PRINT#1, "GPIBEOS IN CR LF"
PRINT#1, "GPIBEOS OUT CR LF"

PRINT #1, "OUTPUT 05;LRN?"    ' send the learn query command
PRINT #1, "ENTER 05"
INPUT #2, fiber, block, srq_mask, cal, atten, wave

' The above variables can be saved in a data file before quitting the program and
' then later read back and used to restore the attenuator to the same state in ATT mode
```

' Like this...

```
PRINT#1, "OUTPUT 05;WVL " ; wave ; ";CAL "; cal ; ";ATT " ; atten ;";D " ; block
```

' Attenuator settings are now restored in ATT mode

END

Sending Queries

This example queries the attenuation and the state of the beam block:

```
OPEN "GPIB0" FOR OUTPUT AS #1
OPEN "GPIB0" FOR INPUT AS #2
PRINT #1, "ABORT"
PRINT #1, "RESET"
PRINT #1, "GPIBEOS IN LF"           ' setting terminating characters to LF
PRINT #1, "GPIBEOS OUT LF"
DIM RESPONSE AS STRING
' Set attenuation to 20 and the state of the beam block to 0 (this turns the beam block on).

PRINT #1, "OUTPUT 05;:INP:ATT 20;:OUTP:STAT 0"

Query device
PRINT #1, "OUTPUT 05;:INP:ATT?;OUTP:STAT?"
PRINT #1, "ENTER 05"
INPUT #2, RESPONSE
PRINT RESPONSE
END
```

' "20.0000; 0" is displayed on the screen

Setting the User Slope

This example demonstrates setting the user slope to match the HA9 attenuator to a power meter. It is not specific to a particular power meter.

```
OPEN "GPIB0" FOR OUTPUT AS #1
OPEN "GPIB0" FOR INPUT AS #2
PRINT #1, "ABORT"
PRINT #1, "RESET"
PRINT #1, "GPIBEOS IN LF"           ' setting terminating characters to LF
PRINT #1, "GPIBEOS OUT LF"

PRINT #1, "OUTPUT 05;*RST"
PRINT #1, "OUTPUT 05;:UCAL:USRM OFF"

PRINT #1, "OUTPUT 05;:STAT:OPER:NTR 2"
PRINT #1, "OUTPUT 05;:INP:ATT 10"   ' change attenuation setting
DO                                   ' wait in loop until attenuator settles
    PRINT #1, "OUTPUT 05;:STAT:OPER:EVENT?"
```

```

        PRINT #1, "ENTER 05"
        INPUT #2, CONDREG
LOOP UNTIL (CONDREG AND 2 = 2)
FOR J = 1 TO 10000:NEXT           ' wait for power meter to settle
GOSUB METER
P1 = POWER

PRINT #1, "OUTPUT 05;;INP:ATT 40"           ' change attenuation setting
DO                                           ' wait in loop until attenuator settles
    PRINT #1, "OUTPUT 05;;STAT:OPER:EVENT?"
    PRINT #1, "ENTER 05"
    INPUT #2, CONDREG
LOOP UNTIL (CONDREG AND 2 = 2)
FOR J = 1 TO 10000:NEXT           ' wait for power meter to settle
GOSUB METER
P2 = POWER

SLOPE = (P1-P2)/30                 ' calculate user slope
PRINT #1, "OUTPUT 05;;UCAL:SLOP ";SLOPE    ' set user slope

PRINT #1, "OUTPUT 05;;UCAL:USRM ON;;INP:ATT 0;OFFS 0"
PRINT #1, "OUTPUT 05;;OUTP:APM ON;POW ";P2;" dBm"           ' put attenuator in absolute
                                                                ' power mode, and set power

' The HA9 attenuator should now match the power meter.
' The power can now be changed using the PWR command.

END

METER:

' This section contains the procedure for reading the power meter. It is dependent on the
' particular meter you are using; therefore, the appropriate terminating characters have to
' be set. The main program expects the power to be returned in the variable POWER.

RETURN

```

SCPI Command Set

The GPIB interface of the attenuator conforms to the ANSI/IEEE standards 488.1-1987 and 488.2-1987. The RS232 interface conforms to ANSI/IEEE standard 488.2-1987 where applicable.

The common commands are defined in ANSI/IEEE 488.2. All other commands conform to the SCPI command language, version 1995.0.

Program Message Formats

A program message consists of a command header, followed by its required parameters. The parameters must be separated from the command header by a space, for example, **:INPUT:ATTENUATION 10**. Multiple parameters must be separated by a comma (,).

Each program message can contain one or more message units. The message units in a program message must be separated by a semicolon (;), for example,

```
:INPUT:ATTENUATION 10;INPUT:OFFSET 20
```

Terminating a Program Message

The terminating sequence <LF> (ASCII character 10) or an EOI sent with character signals the attenuator that the end of the program message has been received. When an EOI is received with any character other than the terminating sequence <LF>, <LF> is put in the input queue immediately after the character. This action applies only to characters sent through the GPIB interface because the RS232 interface does not have an EOI signal.

The terminating sequence <LF> does not always appear in the program examples provided in this section; however, it is implied.

Command Header Variations

Each command header in the command tree has both a long form and a short form. Either form is acceptable and each gives identical responses; for example, the following two message units both set the attenuation to 10 dB.

```
:INPUT:ATTENUATION 10 dB  
:inp:att 10db
```

The query form of a command must end with a question mark; for example, the query form of **:INPUT:ATT** is **:INPUT:ATT?**.

A command can be entered in either uppercase or lowercase characters.

Specifying the Command Path

To use a command in the command tree, the attenuator must know the full path to the command. If the command is the first one in the program message, the command header must contain the full path to the command. Subsequent commands in the same program message are automatically referenced in the same path as the previous command, unless the command header is preceded by a colon (:), in which case the full path to the command must be included in the command header.

```
:INPut  
  :OFFSet          <value>  
    :DISPlay      <value>  
      :WAVelength <value>
```

The following program messages are valid:

```
:INP:OFFS 20; WAV 1200 NM  
:INP:OFFS 20; :INP:WAV 1200 NM  
:INP:OFFS:DISP 20;
```

The following program messages are not valid:

:INP:OFFS 20; INP:WAV 1200 NM (no colon before second command)
:INP:OFFS 20; DISP 1 (DISP command at different level than OFFS)
:INP:OFFS:DISP 1;WAV 1200 NM (WAV command at different level than DISP)

Default Commands

Default commands do not need to be explicitly included in the command path. If a default command for a path exists, it is enclosed by square brackets ([]) in the command tree. If a default command is implied in the first command of a program message, the command path for subsequent commands is determined as if the default command had been explicitly included in the first command header.

```
:OUTPut  
  [:STATe] <boolean>  
  [:STATe?]  
    APOWeron <boolean>  
    APOWeron?  
  :APMode <boolean>
```

The following program messages are valid:

```
:OUTP 1;APM 1  
:OUTP:STATE:APOW 1; APOW?  
:OUTP?;  
:OUTP:STAT?  
:OUTP:APOW?  
:OUTP:STAT:APOW?
```

The following program messages are not valid:

```
:OUTP 1; APOW 1 (the APOW command is not at the same level as STAT)  
:OUT?: (OUT does not exist; use OUTP)
```

Parameter Types

The acceptable parameter types for each command or query are listed in the command table (see the **IEEE 488.2 Common Commands** section). The following are definitions of each parameter type:

- **Numeric Value**—Any value between 9.9E37 and -9.9E37. The value can be sent as an integer (154), a decimal (15.2), or an exponential number (4.5E6). The character data forms MIN (minimum), MAX (maximum), and DEF (default) are also acceptable. Other character data forms can be accepted for specific commands.
- **NRf**—Any value between 9.9E37 and -9.9E37. The value can be sent as an integer (154), a decimal (15.2), or an exponential number (4.5E6). The character data forms MIN, MAX, and DEF are not accepted.

- **Boolean**—0, 1, ON, OFF. Any other numeric value sent is rounded to the nearest integer. If the resulting integer is anything but 0, it is interpreted as 1.
- **Character**—A character string that contains no more than 12 characters. Each character in the string must be either an uppercase or a lowercase letter, a digit (0 to 9), or an underscore (_).
- **String**—Any character string. The characters in the string can be any ASCII character, and the string can be of any length unless otherwise specified in the command table. In order for the attenuator to recognize a single (') or double (") quotation mark as part of the string and not as the end of the string, two sequential single quotation marks or two sequential double quotation marks are used to represent a single quotation mark or a double quotation mark, respectively.
- **Non-Decimal Numeric**—Any binary, octal, or hex value, where the non-decimal numeric values (xxxx) are preceded by the type (T), for example, #Txxxx. T is defined as follows:
 - Octal = # followed by q or Q
 - Hex = # followed by h or H
 - Binary = # followed by b or B

The value (xxxx) following the type must be less than the decimal value 2^{32} and must conform to the following rules for each type:

- Octal values can only contain the numeric characters 0 to 7
- Hex values can only contain the numeric characters 0 to 9 and the letters A to F (both lowercase and uppercase are accepted)
- Binary values can only contain the numeric characters 1 and 0

For example,

- #Q12347 is a valid octal number
- #ha57b2 is a valid hex number
- #B010111 is a valid binary number

Suffixes

Some commands have an optional base unit (see the **IEEE 488.2 Common Commands** section) that can be combined with a multiplier to form a suffix. However, the base unit's dBm and dB cannot be combined with a multiplier. The valid multipliers and their values are listed in Table 8.

Table 8: Valid Multipliers

Multiplier	Value
EX	1E18
PE	1E15
T	1E12
G	1E9
MA	1E6
K	1E3
M	1E-3
U	1E-6
N	1E-9
P	1E-12
F	1E-15
A	1E-18

For example, for the wavelength command that has a base unit of meter (m), the following message formats are valid:

```
:INPUT:WAVELENGTH 1200NM  
:INPUT:WAVELENGTH 1.6e-06 M  
:INPUT:WAVELENGTH 1.4e-09 KM
```

The following message formats are not valid:

```
:INPUT:ATT 50 NDB  
:OUTP:POW 10 mdBm
```

Response Formats

When a query is sent to the attenuator, the attenuator returns a response message.

- Response messages are terminated by the sequence <LF>. If the response is being sent through the GPIB, the EOI is set true when the last character in a response is sent.
- A response message is generated for each query in a program message. Each response message is separated from the next by a semicolon. For example, if the total attenuation is set to 10 dB and the wavelength is set to 1550 nm, the program message **:INP:ATT?;WAV?** returns the response message 10.0000;1.550e-06.

- Each response message can contain multiple pieces of data. Data within a response message is separated by a comma, for example, the query ***IDN?** returns JDS UNIPHASE,HA9X,0,YY.YYY.

Overview of Implemented Status Structures

There are three distinct status data structures implemented in the attenuator:

- IEEE 488.2-defined standard registers (standard status structure)
- SCPI-defined operation registers (operation status structure)
- SCPI-defined questionable registers (questionable status structure)

The standard status structure consists of four registers:

- Status byte register
- Service request enable register
- Standard event status register
- Standard event status enable register

The operation and questionable status structures are identical except for the use of specific bits. These status structures are each composed of five registers:

- Condition register
- Positive transition register (PTRansition)
- Negative transition register (NTRansition)
- Event register
- Event enable register

The bits in the operation status structure reflect a specific condition within the attenuator. The attenuator only uses bit 1 of the operation registers. Bit 1, the settling bit, is set when the attenuator is in the process of adjusting the attenuation.

The bits in the questionable registers give an indication of the quality of the output of the attenuator. None of the bits in the questionable register are currently used by the attenuator.

All three status structures are connected by the status byte register. Figure 13 and Figure 14 show the relationship between the registers.

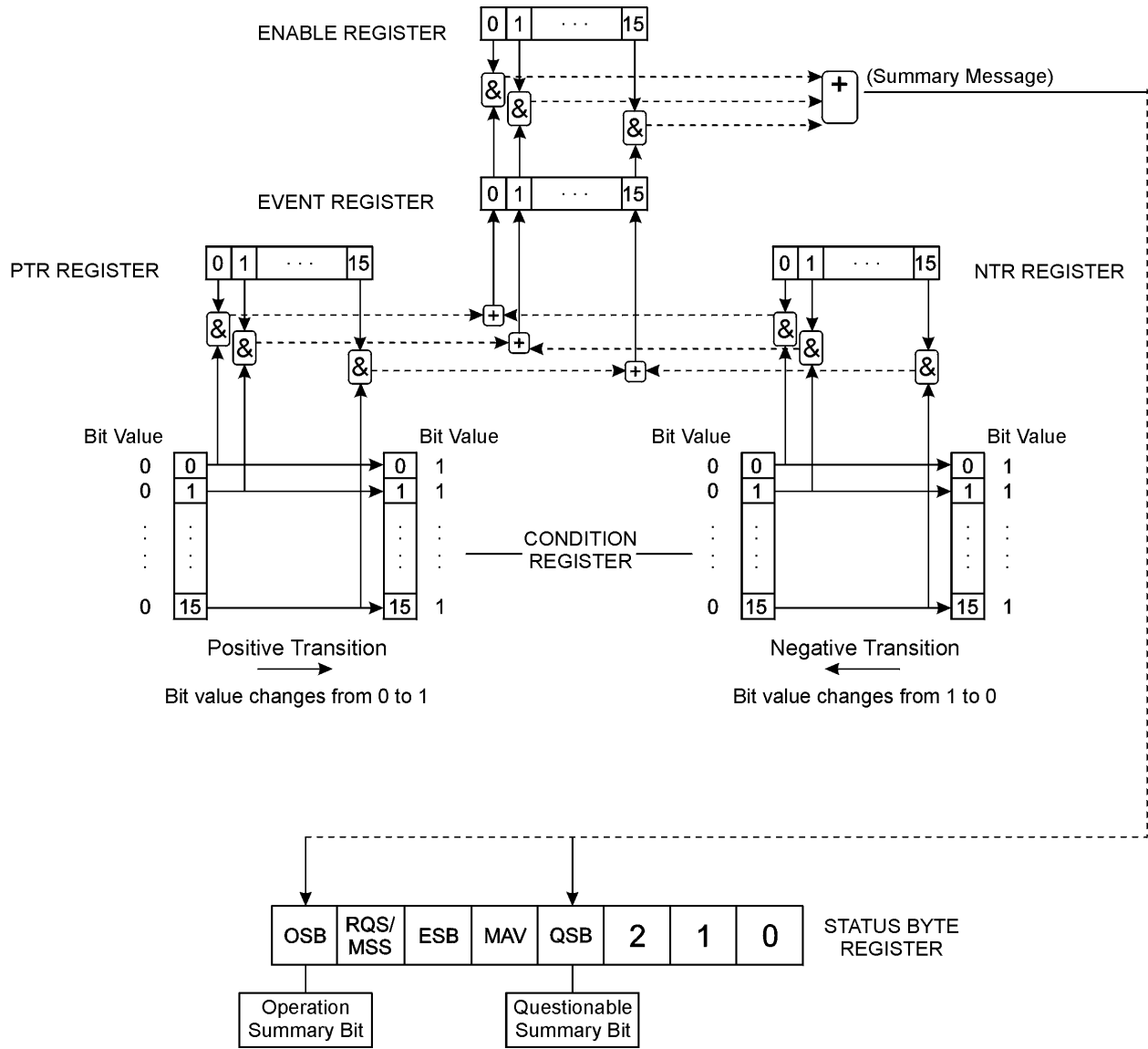

Figure 13: Operational and Questionable Status Data Structures

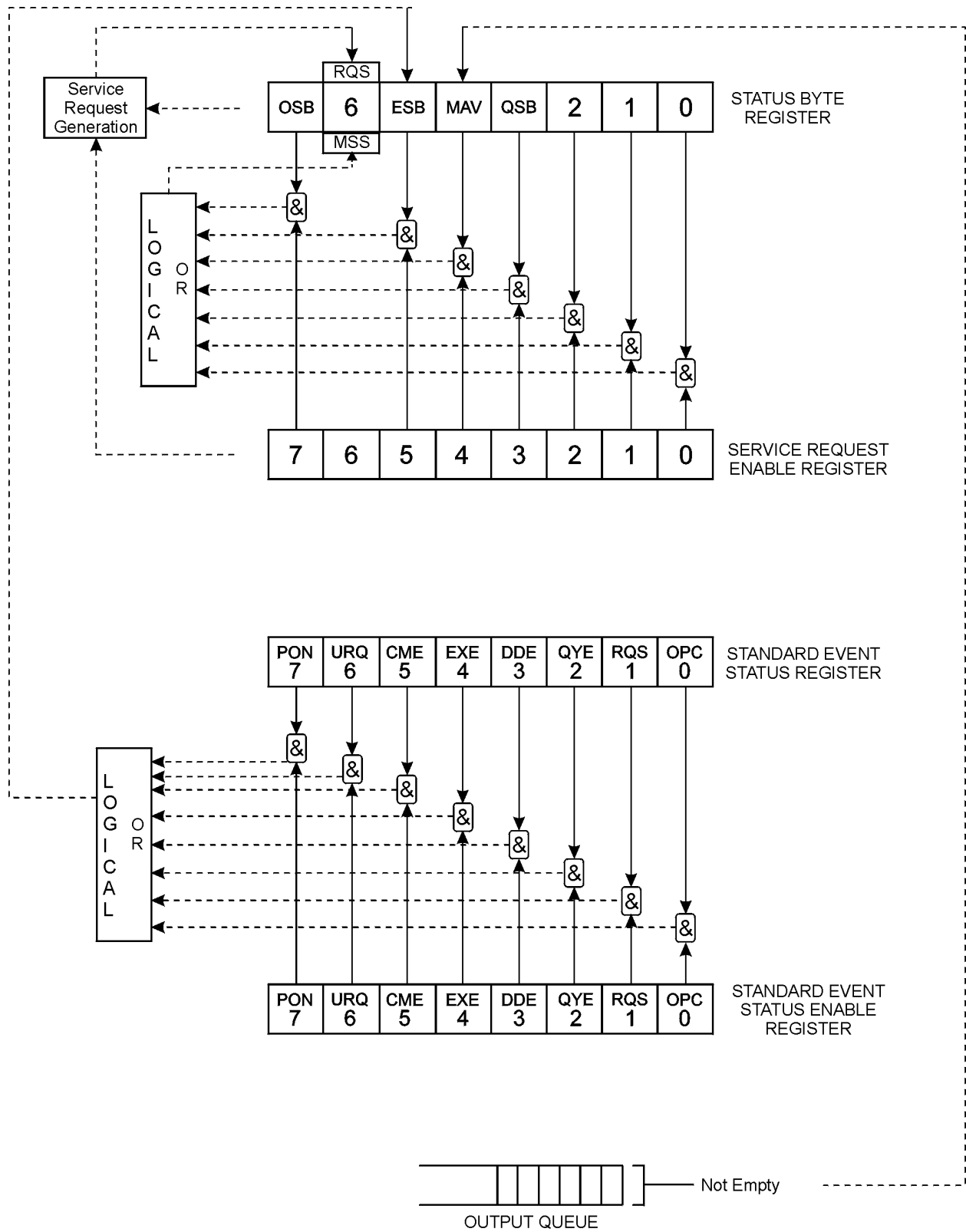

Figure 14: Status Report Model

Status Byte Register

The status byte register contains the summary bits for each of the structures implemented in the attenuator and either the master summary bit (MSB) or the request for service bit (RQS).

Status Byte Register							
Bit 0	Bit 1	Bit 2	Bit 3	Bit 4	Bit 5	Bit 6	Bit 7
not used	not used	not used	questionable summary (QSB)	message available (MAV)	event summary (ESB)	request for service or master summary	operation summary (OSB)
Read with		Serial polling *STB?					
Written to with		Cannot be written to					
Cleared by		*CLS common command					

- Bit 0 is not used.
- Bit 1 is not used.
- Bit 2 is not used.
- Bit 3 (questionable summary) is the summary bit for questionable status structure. It is set if any bit in the questionable event status register is set while the corresponding bit in the questionable event enable register is set.
- Bit 4 (message available) is set to 1 when a response message is available in the output queue.
- Bit 5 (event summary bit) is the summary bit for the standard event status structure. The ESB summary message bit is set if any bit in the standard event status register is set while its corresponding in the standard event status enable register is set.
- Bit 6, as the service request bit, is set to 1 if a service request has been generated. The SRQ bit is set internally and is not visible to the user.

Bit 6, as the master summary bit, is set if there is at least one reason for the attenuator to request service from the controller. That is, the master summary bit is set if any summary bit in the status byte register is set and if the corresponding bit in the service request enable register is also set. The MSB is returned as bit 6 when the status register is queried or the attenuator is serial polled.

- Bit 7 (operation summary bit) is the summary bit for the operation status register. It is set if any bit in the operation event register is set while the corresponding bit in the operation event enable register is set.

Service Request Enable Register

The service request enable register determines which summary bits in the status byte register can generate service requests. If a summary bit in the status register is set to 1 and the corresponding bit in the service request enable register is also set to 1, a service request is generated by the attenuator. A new service request is not generated for this condition unless the bit in the status register or the bit in the service request enable register is cleared and the condition reoccurs.

Standard Request Enable Register	
Read with	* SRE? common query (the value of bit 6 is always 0)
Written to with	* SRE common command (the value of bit 6 is always zero, regardless of the value sent with the command)
Cleared by	* SRE common command with a parameter value of 0 Power-on

Standard Event Status Register

Standard Event Status Register							
Bit 0	Bit 1	Bit 2	Bit 3	Bit 4	Bit 5	Bit 6	Bit 7
operation complete (OPC)	request control (RQC)	query error (QYE)	device dependent error (DDE)	execution error (EXE)	command error (CME)	user request (URQ)	power-on (PON)
Read with		* ESR? common query					
Written to with		Cannot be written to					
Cleared by		* ESR? common query * CLS common command Power-on					

- Bit 0 (operation complete) is set in response to the ***OPC** common command. This bit is set when all operations are complete.
- Bit 1 (request control) is always set to 0.
- Bit 2 (query error) is set when a query error occurs, for example, an attempt is made to read the output queue when the output queue is empty or when the data in the output queue is lost.
- Bit 3 (device dependent error) is set by the attenuator to indicate that an error has occurred that is not a command error, an execution error, or a query error.

- Bit 4 (execution error) is set when an execution error is detected by the attenuator, for example, if a command parameter is out of the range of the attenuator or if a valid program message cannot be executed due to some condition in the attenuator.
- Bit 5 (command error) is set when a command error is detected by the attenuator, for example, if a syntax error is detected in a program message, an incorrect command header is received, or if an IEEE GET message is received in the middle of a program message.
- Bit 6 (user request) is always set to 0.
- Bit 7 (power on) is set when an off-to-on transition occurs in the power supply of the attenuator.

Standard Event Status Enable Register

The contents of the standard event status enable register determine which events in the standard event status register are reflected in the event summary bit (ESB) of the status byte register.

Standard Event Status Enable Register	
Read with	* ESE? common query
Written to with	* ESE common command
Cleared by	Power-on * ESE common command with a parameter value of 0

Operation and Questionable Condition Registers

Each bit in these condition registers reflects a specific condition or state within the attenuator. A bit is set when the attenuator enters the state associated with that bit and remains set while the device is in that state.

Operation Condition Register	
Read with	STATus:OPERation:CONDition? query
Written to with	Cannot be written to
Cleared by	Power-on

Questionable Condition Register	
Read with	STATus:QUEStionable:CONDition? query
Written to with	Cannot be written to
Cleared by	Power-on

Operation and Questionable Event Registers

Event registers reflect changes in the conditions of the attenuator. Each bit in the operation event register and the questionable event register is associated with a bit in the corresponding condition register. Depending on the values of the positive transition register and the negative transition register, a bit in the event register can be set when the associated bit in the condition register changes from 0 to 1, from 1 to 0, or both. If both the positive transition and negative transition bits are set to 0, the event register bit is not set on either transition.

Operation Event Register	
Read with	STATUS:OPERation:EVENT? query
Written to with	Cannot be written to
Cleared by	*CLS common command

Questionable Event Register	
Read with	STATUS:QUEStionable:EVENT? query
Written to with	Cannot be written to
Cleared by	Power-on *CLS common command

Operation and Questionable Event Enable Registers

The event enable registers determine which event bits in the associated event register cause the summary message bit in the status byte register to be set. If any event bit in the event register is set while its associated bit in the event enable register is also set, the summary message bit is set to true.

Operation Event Enable Register	
Read with	STATUS:OPERation:ENABle? query
Written to with	STATUS:OPERation:ENABle command
Cleared by	Power-on

Questionable Event Enable Register	
Read with	STATUS:QUEStionable:ENABle? query
Written to with	STATUS:QUEStionable:ENABle command
Cleared by	Power-on

Operation and Condition Positive Transition Registers

If a bit in the positive transition register is set, a positive transition (a transition from 0 to 1) in the associated bit in the condition register sets the associated bit in the event register.

Operation Positive Transition Register	
Read with	STATus:OPERation:PTRansition? query
Written to with	STATus:OPERation:PTRansition command
Cleared by	Power-on

Condition Positive Transition Register	
Read with	STATus:QUEStionable:PTRansition? query
Written to with	STATus:QUEStionable:PTRansition command
Cleared by	Power-on

Operation and Questionable Negative Transition Registers

If a bit in the negative transition register is set, then a negative transition (a transition from 1 to 0) in the associated bit in the condition register causes the associated bit in the event register to be set.

Operation Negative Transition Register	
Read with	STATus:OPERation:NTRansition? query
Written to with	STATus:OPERation:NTRansition command
Cleared by	Power-on

Condition Negative Transition Register	
Read with	STATus:QUEStionable:NTRansition? query
Written to with	STATus:QUEStionable:NTRansition command
Cleared by	Power-on

Input Queue

The input queue of the attenuator is a first-in-first-out (FIFO) queue and is 100 bytes long. Data bytes received from the controller are placed in the input queue in the order that they are received. When a full message unit is received, it is transferred to the parser.

If the input queue becomes full while the GPIB is being used, the data acknowledge signal (DAQ) is not sent to the GPIB controller until a character is transferred from the input buffer to the parser. This ensures that no bytes in the program message are lost. The RS232 interface has no DAQ signal and, therefore, cannot be signaled when the input buffer is full. If a new program message is received before the response to a query in a previous message is read, the output queue is cleared, MAV is set false, and the query error bit is set. This error is also referred to as an unterminated error.

Output Queue

Responses to query messages are placed in the output queue. This queue is 100 bytes long. When a response is placed in the output queue, the MAV bit in the status register is set. The MAV bit is cleared when the response is sent.

If an attempt is made to read the output queue when it is empty and the current program message does not contain a query, a query error bit is set.

Error Queue

Errors are placed in the error queue. This queue is 100 bytes long. Because it is an FIFO queue, the error returned when the error queue is read is always the first error that occurred. An error is only placed in the queue once.

If more than three errors are placed in the error queue, an overflow error occurs and the last error in the queue is overwritten with error number -350 (Queue Overflow). Each error in the queue consists of an error number and a brief error message.

Description of Error Numbers

0	No error
----------	-----------------

No error has occurred.

-100	Command error
-------------	----------------------

A command error was detected, but the parser cannot be more specific.

-102	Syntax error
-------------	---------------------

The command or data was not recognized.

-103	Invalid separator
-------------	--------------------------

The parser was expecting a separator and did not find one.

-104	Data type error
-------------	------------------------

A parameter was not the right type; for example, a string was expected but a non-decimal numeric was received.

-108	Parameter not allowed
-------------	------------------------------

More parameters were received than the command or query requires.

-109

Missing parameter

Fewer parameters were received than the command or query requires.

-110

Command header error

An error was detected in the command header, but the parser cannot be more specific.

-111

Header separator error

A character that was not a valid header separator was encountered.

-112

Program mnemonic too long

The command header contained too many characters.

-113

Undefined header

The command header has the correct syntax but is not defined for the attenuator.

-114

Header suffix out of range

The suffix was incorrect.

-120

Numeric data error

An error was detected in a numeric data element, but the parser cannot be more specific.

-121

Invalid character in number

An invalid character was found in a character-type parameter.

-123

Exponent too large

The exponent in a decimal numeric value was greater than 32,000.

-124

Too many digits

The mantissa in a decimal numeric value had more than 255 digits.

-128

Numeric data not allowed

A valid numeric parameter was received, but the required parameter type is not numeric.

-130

Suffix error

An error was detected in the suffix sent with the command, but the parser cannot be more specific.

-134

Suffix too long

The suffix sent with the command was more than 12 characters long.

-140

Character data error

An error was detected in a character type parameter, but the parser cannot be more specific.

-141

Invalid character data

An invalid character was detected in a character-type parameter.

-144

Character data too long

A character-type parameter contained more than 12 characters.

-200

Execution error

An execution error has occurred, but the control block cannot be more specific.

-220

Parameter error

An error was detected in a parameter, but the control block cannot be more specific.

-221

Settings conflict

A valid parameter was received, but it cannot be used due to the current state of the attenuator.

-222

Data out of range

A valid parameter type was received, but it is out of range for the attenuator.

-223

Too much data

A block-, expression-, or string-data type was too long for the attenuator to process.

-224

Illegal parameter value

A valid parameter type was received, but it did not match any of the permitted values.

-240

Hardware error

A command cannot be executed due to a hardware error, but the control block cannot be more specific.

-300

Device-specific error

A device-specific error occurred, but more specific information is unavailable.

-310

System error

An instrument system error has occurred.

-313

Save/recall memory lost

The non-volatile data saved by the command ***SAV** has been lost.

-330

Self-test failed

The device failed a self-test.

-350

Queue overflow

The error queue has overflowed, and an error has occurred that cannot be recorded.

-400

Query error

A query error was detected, but the parser cannot be more specific.

-410

Query interrupted

An interrupted error occurred; for example, an attempt was made to read the output queue before a query had been received.

-420

Query unterminated

An unterminated error occurred; for example, a new program message was sent before the response to a previous query was read.

-430**Query deadlocked**

The device was deadlocked. Both the input buffer and output queue are full, and the attenuator is unable to continue.

??**Undefined error number**

An undefined error occurred.

SCPI Command Tree

All commands other than the IEEE 488.2 common commands are listed in Table 9. The following abbreviations are used in the Command Status column:

- SC (SCPI-confirmed command)
- SA (SCPI-approved command)
- N (command is neither SCPI confirmed nor approved)

Table 9: SCPI Commands

Command	Parameters	Response	Unit	MIN	MAX	DEF	Command Status
:DISPlay							
:BRIGhtness	Numeric Value			0	1	1	SC
:BRIGhtness?	MAX MIN DEF	1		0	1	1	SC
:ENABle	Boolean						SC
:ENABle?		NRf					SC
:INPut							
:ATTenuation	Numeric Value		dB	0.00 ⁶	100.00 ⁷	0	SC
:ATTenuation?	MAX MIN DEF	NRf	dB	0.00 ⁷	100.00 ⁷	0	SC
:LCMode	Boolean						N
:LCMode?		NRf					N
:MINLoss							N
:OFFSet	Numeric Value		dB	0.00	99.99	0	SC
:DISPlay							N

⁶ :INP:ATT sets the total attenuation, and :INP:ATT? returns the total attenuation. Therefore, the maximum value for this command and query is the current offset (100 or 60 dB depending on the model). The minimum and default values are the current offset 0.dB.

Command	Parameters	Response	Unit	MIN	MAX	DEF	Command Status
(table continued)							
:OFFSet?	MAX MIN DEF	NRf	dB	0.00	99.99	0	SC
:WAVelength	Numeric Value		M	1200NM	1700NM	1310NM	N
:WAVelength?	MAX MIN DEF	NRf	M	1200NM	1700NM	1310NM	N
:OUTPut							
[:STATe]	Boolean						N
[:STATe?]		NRf					N
:APOWeron	Boolean DIS LAST						N
:APOWeron?		NRf					N
:APMode	Boolean						N
:APMode?		NRf					N
:DRIVer	Boolean						N
:DRIVer?		NRf					N
:POWer	Numeric Value		dBm	0.00 ⁷	100.00 ⁸	0.00	N
:POWer?	MAX MIN DEF	NRf	dBm	0.00 ⁸	100.00 ⁸	0.00	N
:STATus							
:OPERation							
[:EVENT]?		NRf					SC
:CONDition?		NRf					SC
:ENABle	NRf			0	32,76	?	SC
:ENABle?		NRf					SC
:NTRansition	NRf			0	32,76		SC
NTRansition?		NRf					SC
:PTRansition	NRf			0	32,76		SC
		NRf					SC

⁷ **:OUTP:POW** sets the through power, and **:OUTP:POW?** returns the through power. The maximum dB value for this command is the through power for which the actual attenuation is 100 or 60 dB, depending on the model. The minimum and default values are the through power, for which the actual attenuation is 0 dB.

Command	Parameters	Response	Unit	MIN	MAX	DEF	Command Status
PTRansition?							

(table continued)

:QUEStionable							
[:EVENT]?		NRf					SC
:CONDition?		NRf					SC
:ENABle	NRf			0	32,76		SC
:ENABle?		NRf					SC
:NTRansition	NRf			0	32,76		SC
NTRansition?		NRf					SC
:PTRansition	NRf			0	32,76		SC
PTRansition?		NRf					SC
:PRESet							
:SYSTem							
:ERRor?		NRf , String					SC
:VERSion?		String					SC
:UCALibration							
:USRMode	Boolean						N
:USRMode?		NRf					N
:SLOPe	Numeric Value			0.0	2.0	1.0	N
:SLOPe?		NRf					N

Common Commands

Clear Status Command

Syntax	*CLS
Function	<p>Clears the following queues and registers:</p> <ul style="list-style-type: none">• Error queue• Standard event status register• Status byte register• Operation event register• Questionable event register <p>If *CLS is sent immediately after a message terminating sequence, both the output queue and the MAV bit in the status byte register are cleared. *CLS also cancels the functions of *OPC and *OPC?.</p>
Example	*CLS

Standard Event Status Enable Register Command

Syntax	*ESE<space><numeric value> where $0 \leq \text{<numeric value>} \leq 255$
Function	Sets the bits in the standard event status enable register. The numeric value is rounded to the nearest integer and converted to a binary number. The bits of the register are set to match the bit values of the binary number.
Example	*ESE 216 sets the standard event status enable register bits to 11011000.

Standard Event Status Enable Register Query

Syntax	*ESE?
Function	Returns the contents of the standard event status enable register as an integer that, when converted to a binary number, represents the bit values of the register
Example	*ESE? returns 216 if the standard event status enable register is set to 11011000.

Standard Event Status Register Query

Syntax	*ESR?
Function	Returns the contents of the standard event status register as an integer that, when converted to a binary number, represents the bit values of the register
Example	*ESR? returns 195 if the standard event status register is set to 11000011.

Identification Query

Syntax	*IDN?
Function	Returns a string that identifies the manufacturer, the HA9 model number, the serial number (or 0 if unavailable) and the firmware level.

Example	*IDN? returns JDS UNIPHASE, HA9X, 0, YY.YYY
---------	--

Operation Complete Command

Syntax	*OPC
Function	Causes the attenuator to set the OPC bit in the standard event status register when all pending operations have been completed.
Example	*OPC

Operation Complete Query

Syntax	*OPC?
Function	Places a "1" in the output queue of the attenuator when all pending operations have been completed. Because the "1" is not always placed in the output queue immediately, poll the status byte register and check the MAV bit to determine if there is a message available in the output queue.
Example	*OPC?

Option Identification Query

Syntax	*OPT?
Function	Reports on options installed or included with the attenuator.
Example	*OPT? returns ??? in all cases (attenuator has no defined device options).

Recall Command

Syntax	*RCL <space><numeric value> where $0 \leq \text{<numeric value>} \leq 9$
Function	Restores the attenuator to a state that has been stored in local memory. Restoring to state 0 (*RCL 0) is equivalent to sending the *RST command. See the Save Command for a list of settings that are stored for each state.
Example	*RCL 4

Reset Command

Syntax	*RST
Function	Restores the attenuator to the following settings: <ul style="list-style-type: none"> • Total attenuation = 0 dB • Display offset = 0 dB • Wavelength = 1310 nm • LCM state = OFF • Absolute power mode state = OFF • Beam block state at power on = LAST • Beam block state = ON
Example	*RST

Save Command

Syntax	*SAV<space><numeric value> where $1 \leq \text{<numeric value>} \leq 9$
Function	Stores the current state of the attenuator in local memory; as many as nine states can be stored. For each state, the following settings are stored: <ul style="list-style-type: none">• Total attenuation• Display offset• Wavelength• LCM state (ON or OFF)• Absolute power mode (ON or OFF)• Beam block state at power-on (OFF or LAST)• Beam block state (ON or OFF)
Example	*SAV 3

Service Request Enable Command

Syntax	*SRE<space><numeric value> where $0 \leq \text{<numeric value>} \leq 255$
Function	Sets the bits in the service request enable register. The numeric value is rounded to the nearest integer and converted to a binary number. The bits of the register are set to match the bit values of the binary number.
Example	*SRE 216 sets the service request enable register bits to 11011000.

Service Request Enable Query

Syntax	*SRE?
Function	Returns the contents of the service request enable register as an integer that, when converted to a binary number, represents the bit values of the register
Example	*SRE? returns 195 if the service request enable register is set to 11000011.

Read Status Byte Query

Syntax	*STB?
Function	Returns the contents of the status byte register as an integer that, when converted to a binary number, represents the bit values of the register. The bit value for bit 6 of the register is the MSS bit value, not the RQS bit value.
Example	*STB? returns 170 if the status byte register is set to 10101010.

Self-Test Query

Syntax	*TST?
Function	Initiates a self-test of the attenuator, and returns 0 if the attenuator passes the self-test or 1 if it fails.
Example	*TST?

*WAI Command

Syntax	*WAI
Function	Prevents the attenuator from executing any further commands or queries until all pending operations have been completed.
Example	:INP:ATT 10;WAI;INP:OFF? prevents the attenuator from reading the offset until it has completed setting the attenuation to 10 dB.

DISPlay Commands

:DISPlay:BRIGhtness

Syntax	:DISPlay:BRIGhtness<space><numeric value> where $0 \leq \text{<numeric value>} \leq 1$
Function	Sets the brightness of the LCD display. Because the display brightness can only be set to 1, the numeric value is rounded to 1. This command is implemented only to maintain compatibility with the HP 8156A attenuator.
Example	:DISP:BRIG 1.0

:DISPlay:BRIGhtness?

Syntax	:DISPlay:BRIGhtness?
Function	Returns the brightness setting for the display.
Example	:DISP:BRIG 0.5;BRIG? returns 1 in all cases.

:DISPlay:ENABle

Syntax	:DISPlay:ENABle <boolean>
Function	This command enables or disables a display on the attenuator. However, because the attenuator display cannot be turned off, the command has no effect. It is implemented only to maintain compatibility with the HP 8156A attenuator.
Example	:DISP:ENAB 1

:DISPlay:ENABle?

Syntax	:DISPlay:ENABle?
Function	Returns the current state of the display.
Example	:DISP:ENAB 0;ENAB? returns 1 in all cases.

INPut Commands

:INPut:ATTenuation

Syntax	:INPut:ATTenuation <space> <numeric value> [dB]
Function	<p>Sets the total attenuation to the parameter value by changing the actual attenuation. Because the total attenuation includes the offset, the actual attenuation of the attenuator is set according to the following formula:</p> $\text{Att}_{\text{actual}} = \text{Att}_{\text{total}} - \text{Offset}$ <p>This command also accepts the parameters MIN, MAX, and DEF. The minimum total attenuation is the total attenuation at which the actual attenuation is 0 dB. The maximum total attenuation is the total attenuation at which the actual attenuation is 30 dB. The default total attenuation is the same as the minimum attenuation.</p>
Example	:INP:OFFS 30;INP:ATT 40 sets the total attenuation to 40 dB and the actual attenuation to 10 dB (for example, 40 dB - 30 dB = 10 dB).

:INPut:ATTenuation?

Syntax	:INPut:ATTenuation? [<space>MAX MIN DEF]
Function	<p>Returns the current total attenuation in dB. The total attenuation is the total of the actual attenuation and the offset:</p> $\text{Att}_{\text{total}} = \text{Att}_{\text{actual}} + \text{Offset}$ <p>This query also accepts the parameters MIN, MAX, and DEF. The minimum, maximum, or default value for the total attenuation at the current offset setting is returned.</p>
Example	:INP:ATT? MAX returns the current offset plus 100 dB (the maximum actual attenuation of the standard HA9 unit) or 60 dB (the maximum actual attenuation of the HA9 wide unit).

:INPut:LCMode

Syntax	:INPut:LCMode <space> <boolean>
Function	<p>Sets the process by which the wavelength calibration is implemented when the wavelength is changed.</p> <p>A boolean value of 1 or ON activates LCM mode. In LCM mode, the total attenuation remains fixed when the wavelength is changed, for example, the attenuator prism is moved to give the same attenuation at the new wavelength.</p> <p>A boolean value of 0 or OFF deactivates LCM mode. When LCM mode is turned off, the actual attenuation changes (as well as the total attenuation) when the wavelength is changed, for example, the attenuator prism does not move when the wavelength is changed.</p>
Example	<p>:INP:WAV 1300 NM;ATT 10;LCMode ON;WAV 1550 NM sets the total attenuation to 10 dB, and the total attenuation remains at 10 dB when the wavelength is changed from 1300 nm to 1550 nm.</p> <p>:INP:WAV 1550 NM;ATT 10;LCMode OFF;WAV 1300 NM sets the total attenuation to 10 dB, but the total attenuation changes slightly when the wavelength is changed from 1550 nm to 1300 nm.</p>

:INPut:LCMode?

Syntax	:INPut:LCMode?
Function	Returns the current state of LCM mode, for example, returns 1 if LCM mode is ON and 0 if LCM mode is OFF.
Example	:INP:LCM ON;LCM? returns 1.

:INPut:OFFSet

Syntax	:INPut:OFFSet <space> <numeric value> [<suffix>]
Function	<p>Sets the display offset of the attenuator. The value of the offset has no effect on the actual attenuation, but it does affect the total attenuation, for example,</p> $Att_{total} = Att_{actual} + Offset$ <p>This command also accepts the parameters MIN, MAX, and DEF. The minimum offset is -29.99 dB, the maximum offset is 29.99 dB, and the default offset is 0.</p>
Example	:INP:OFFS 10 sets the offset to 10 dB. If the actual attenuation is 14 dB, the total attenuation is 24 dB.

:INPut:OFFSet?

Syntax	:INPut:OFFSet? [<space> <MIN MAX DEF>]
Function	Returns the current setting of the display offset. The query accepts the parameters MIN, MAX, and DEF to return the minimum, maximum, or default value (respectively) for the display attenuation at the current offset setting.
Example	:INP:OFFS 16;OFF? returns 16. :INP:OFFS? MIN? returns 0.

:INPut:OFFSet:DISPlay

Syntax	:INPut:OFFSet:DISPlay
Function	Sets the display offset so that the total attenuation is 0 dB: $\text{Offset}_{\text{new}} = \text{Att}_{\text{total}} - \text{Offset}_{\text{old}} = -\text{Att}_{\text{act}}$
Example	:INP:OFFS:DISP sets the offset to -20 dB if the previous total attenuation was 30 dB and the previous offset was 10 dB.

:INPut:WAVelength

Syntax	:INPut:WAVelength <space> <numeric value> [<suffix>]
Function	Sets the calibration wavelength of the attenuator. Because the calibration wavelength is used to account for the wavelength dependence of the attenuation, set the calibration wavelength as close as possible to the source wavelength. This command also accepts the parameters MIN, MAX and DEF. The minimum wavelength is 1200 nm, the maximum wavelength is 1700 nm, and the default wavelength is 1310 nm.
Example	:INP:WAV 1550 nm

:INPut:WAVelength?

Syntax	:INPut:WAVelength? [<space> <MAX MIN DEF>]
Function	Returns the current setting of the calibration wavelength in meters. This query also accepts the parameters MIN, MAX, and DEF, returning the minimum, maximum, or default value (respectively) for the calibration wavelength.
Example	:INP:WAV 1300 nm;WAV? returns 1.3e-06.

OUTPut Commands

:OUTPut:APMode

Syntax	:OUTPut:APMode <space> <boolean>
Function	<p>Sets whether the actual attenuation of the attenuator is set by changing the total attenuation or by changing the through power.</p> <p>When absolute power mode is set to ON, the actual attenuation is set by setting the through power rather than the total attenuation. The base through power, otherwise referred to as the power mode offset, is automatically set to the total attenuation when absolute power mode is activated:</p> $\text{ThroughPower}_{\text{base}} = \text{ATT}_{\text{total at apmode on}} = \text{ATT}_{\text{actual}} + \text{Offset}$ <p>This value differs from setting the power mode offset manually (using the keypad) because the attenuator is not set to power mode before the power mode offset is adjusted.</p> <p>To match the display of the attenuator to that of a power meter, adjust the offset until the attenuator display matches the power meter display, then turn on the absolute power mode and set the through power as required.</p> <p>The absolute power mode is turned off automatically when any of the following commands or their associated queries are received by the attenuator:</p> <ul style="list-style-type: none">• :INP:ATT• :INP:OFFS• :INP:OFFS:DISP
Example	:OUTP:APM ON sets absolute power mode to ON.

:OUTPut:APMode?

Syntax	:OUTPut:APMode?
Function	Returns the current absolute power mode state, for example, returns 1 if absolute power mode is ON (the actual attenuation is set by throughput) and 0 if absolute power mode is OFF (the actual attenuation is set by the total attenuation).
Example	:OUTP:APM 1;APM? returns 1.

:OUTPut:DRIVER

Syntax	:OUTPut:DRIVER <space> <boolean>
Function	Sets the state of the 5 V output. A boolean value of 1 or ON turns the 5 V output on. A boolean value of 0 or OFF turns the 5 V output off.
Example	:OUTP:DRIV ON turns the 5 V output on.

:OUTPut:DRIVer?

Syntax	:OUTPut:DRIVer
Function	Returns 1 if the 5 V output is on and 0 if the 5 V output is off.
Example	: OUTP:DRIV OFF;DRIV? returns 0.

:OUTPut:POWer

Syntax	:OUTPut:POWer <space> <numeric value> [dBm]
Function	<p>Sets the through power of the attenuator. The through power is used to set the actual attenuation of the attenuator.</p> <p>This command also accepts the parameters MIN, MAX, and DEF. The minimum through power is the through power for which the actual attenuation is 100 dB for the standard HA9 model and 60 dB for the HA9W (wide) model. The maximum through power is the through power for which the actual attenuation is 0 dB. The default through power is the same as the maximum through power.</p>
Example	: OUTP:POW -34.55

:OUTPut:POWer?

Syntax	:OUTPut:POWer? [<space> <MIN MAX DEF>]
Function	Returns the current through power of the attenuator in dBm. This query also accepts the parameters MIN, MAX, and DEF. The minimum, maximum, or default value (respectively) for the through power at the current base through power is returned.
Example	: OUTP:POW?

:OUTPut[:STATe]

Syntax	:OUTPut[:STATe] <space> <boolean>
Function	<p>Sets the state of the beam block. A boolean value of 0 or OFF leaves the beam block in the beam (the default position) thereby turning off the optical power from the attenuator. When the beam block is in the beam, the attenuation of the attenuator is >110 dB.</p> <p>A boolean value of 1 or ON moves the beam block out of the beam, thereby turning on the optical power out of the attenuator.</p> <p>The attenuation setting of the attenuator is not affected by the beam block state.</p>
Example	<p>:OUTP OFF leaves the beam block in the beam.</p> <p>:OUTP:STAT ON removes the beam block from the beam.</p>

:OUTPut[:STATe]?

Syntax	:OUTPut[:STATe]?
Function	Returns the state of the beam block: 1 if the beam block is out of the beam and 0 if the beam block is in the beam.
Example	:OUTP ON;STAT? returns 1. :OUTP OFF;STAT? returns 0.

:OUTPut[:STATe]:APOWeron

Syntax	:OUTPut[:STATe]:APOWeron <space> <boolean DIS LAST>
Function	Sets the state of the beam block at power-on: DIS, OFF, or 0 leaves the beam block in the beam, and 1, ON, or LAST sets the beam block state at power-on to the same state that the beam block was in at power-off.
Example	:OUTP:APOW LAST when the attenuator is powered on, restores the beam block state to the same state it was in when the attenuator was powered off. :OUTP:STAT:APOW DIS leaves the beam block in the beam at power-on.

:OUTPut[:STATe]:APOWeron?

Syntax	:OUTPut[:STATe]:APOWeron?
Function	Returns the state of the beam block at power-on: 1 if the beam block is set to the same state that it was in at power-off and 0 if the beam block state is in the beam.
Example	:OUTP:APOW 1;;OUTP:APOW? returns 1.

Status Commands**:STATus:OPERation:CONDition?**

Syntax	:STATus:OPERation:CONDition?
Function	Returns the contents of the operation condition register as an integer that, when converted to a binary number, represents the bit values of the register. The attenuator only uses bit 1 of the operation condition register. Bit 1, the settling bit, is set when the attenuator is in the process of adjusting the actual attenuation.
Example	:STAT:OPER:COND?

:STATus:OPERation:ENABLE

Syntax	:STATus:OPERation:ENABLE <space> <NRf>
Function	Sets the bits in the operation enable register. The NRf value is rounded to the nearest integer and converted to a binary number. The bits of the register are set to match the bit values of the binary number.
Example	:STAT:OPER:ENAB 32.8 sets bit 0 and bit 5 of the operation enable register to 1.

:STATus:OPERation:ENABLE?

Syntax	:STATus:OPERation:ENABLE?
Function	Returns the contents of the operation event enable register as an integer that, when converted to a binary number, represents the bit values of the register.
Example	:STAT:OPER:ENAB 23;ENAB? returns 23.

:STATus:OPERation[:EVENT]?

Syntax	:STATus:OPERation[:EVENT]?
Function	Returns the contents of the operation event register as an integer that, when converted to a binary number, represents the bit values of the register.
Example	:STAT:OPER:EVENT?

:STATus:OPERation:NTRansition

Syntax	:STATus:OPERation:NTRansition <space> <NRf>
Function	Sets the bits of the operation negative transition register. The NRf value is rounded to the closest integer and converted to a binary number. The bits of the register are set to match the bits of the binary number.
Example	:STAT:OPER:NTR 256 sets the bits of the operation negative transition register to 0000000011111111.

:STATus:OPERation:NTRansition?

Syntax	:STATus:OPERation:NTRansition?
Function	Returns the contents of the operation negative transition register as an integer that, when converted to a binary number, represents the bit values of the register.
Example	:STAT:OPER:NTR 12;NTR? returns 12.

:STATus:OPERation:PTRansition

Syntax	:STATus:OPERation:PTRansition <space> <NRf>
Function	Sets the bits of the operation positive transition register. The NRf value is rounded to the closest integer and converted to a binary number. The bits of the register are set to match the bits of the binary number.

Example	:STAT:OPER:PTR 255 sets the bits of the operation positive transition register to 0000000011111110.
---------	--

:STATus:OPERation:PTRansition?

Syntax	:STATus:OPERation:PTRansition?
Function	Returns the contents of the operation positive transition register as an integer that, when converted to a binary number, represents the bit values of the register.
Example	:STAT:OPER:PTR 12;PTR? returns 12.

:STATus:QUEStionable:CONDition?

Syntax	:STATus:QUEStionable:CONDition?
Function	Returns the contents of the questionable condition register as an integer that, when converted to a binary number, represents the bit values of the register. The attenuator only uses bit 1 of the register. Bit 1, the settling bit, is set when the attenuator is in the process of adjusting the actual attenuation.
Example	:STAT:QUES:COND?

:STATus:QUEStionable:ENABLE

Syntax	:STATus:QUEStionable:ENABLE <space> <NRf>
Function	Sets the bits in the questionable enable register. The NRf value is rounded to the nearest integer and converted to a binary number. The bits of the register are set to match the bit values of the binary number.
Example	:STAT:QUES:ENAB 32.8 sets bit 0 and bit 5 of the questionable enable register to 1.

:STATus:QUEStionable:ENABLE?

Syntax	:STATus:QUEStionable:ENABLE?
Function	Returns the contents of the questionable event enable register as an integer that, when converted to a binary number, represents the bit values of the register.
Example	:STAT:QUES:ENAB 23;ENAB? returns 23.

:STATus:QUEStionable[:EVENT]?

Syntax	:STATus:QUEStionable[:EVENT]?
Function	Returns the contents of the questionable event register as an integer that, when converted to a binary number, represents the bit values of the register
Example	:STAT:QUES:EVENT?

:STATus:QUEStionable:NTRansition

Syntax	:STATus:QUEStionable:NTRansition <space> <NRf>
Function	Sets the bits of the questionable negative transition register. The NRf value is rounded to the closest integer and converted to a binary number. The bits of the register are set to match the bits of the binary number.
Example	:STAT:QUES:NTR 256 sets the bits of the questionable negative transition register to 0000000011111111.

:STATus:QUEStionable:NTRansition?

Syntax	:STATus:QUEStionable:NTRansition?
Function	Returns the contents of the questionable negative transition register as an integer that, when converted to a binary number, represents the bit values of the register.
Example	:STAT:QUES:NTR 12;NTR? returns 12.

:STATus:QUEStionable:PTRansition

Syntax	:STATus:QUEStionable:PTRansition <space> <NRf>
Function	Sets the bits of the questionable positive transition register. The NRf value is rounded to the closest integer and converted to a binary number. The bits of the register are set to match the bits of the binary number.
Example	:STAT:QUES:PTR 255 sets the bits of the questionable positive transition register to 0000000011111110.

:STATus:QUEStionable:PTRansition?

Syntax	:STATus:QUEStionable:PTRansition?
Function	Returns the contents of the questionable positive transition register as an integer that, when converted to a binary number, represents the bit values of the register.
Example	:STAT:QUES:PTR 12;PTR? returns 12.

:STATus:PRESet

Syntax	:STATus:PRESet
Function	This command presets all the enable and transition registers in the questionable and operation registers to the following settings: <ul style="list-style-type: none"> • All bits in the ENABle registers are set to 0 • All bits in the positive transition registers are set to 1 • All bits in the negative transition registers are set to 0
Example	:STAT:PRES

System Commands

:SYSTem:ERRor?

Syntax	:SYSTem:ERRor?
Function	Returns the next error message in the error queue. Because the error queue is an FIFO queue, the error returned is the oldest unread error. The error message consists of an error number followed by an error message, for example, 0, No Error See the Error Queue section for a list of error numbers and their associated messages.
Example	: SYST:ERR?

:SYSTem:VERSion?

Syntax	:SYSTem:VERSion?
Function	Returns the formatted numeric value corresponding to the SCPI version number to which the attenuator complies.
Example	: SYST:VERS? returns 1995.0

User Commands

:UCALibration:USRMmode

Syntax	:UCALibration:USRMmode <space> <boolean>
Function	Sets user mode on or off. A boolean value of 1 or ON turns user mode on and the HA9 uses the current user slope instead of the factory-set slope. A boolean value of 0 or OFF turns user mode off and the HA9 uses the factory-set slope.
Example	: UCAL:USRM ON sets user mode to ON.

:UCALibration:USRMmode?

Syntax	:UCALibration:USRMmode?
Function	Returns the current setting of user mode, that is, returns 1 if user mode is on and 0 if user mode is off.
Example	: UCAL:USRM OFF;USRM? returns 0.

:UCALibration:SLOPe

Syntax	:UCALibration:SLOPe <space> <numeric value>
Function	Sets the user slope. The slope of the attenuator can be matched to a power meter for a given source by adjusting the user slope. This command also accepts the parameters MIN, MAX, and DEF. The minimum value for the slope is 0.5, the maximum value is 2.0, and the default value is 1.0.
Example	:UCAL:SLOP 1.75

:UCALibration:SLOPe?

Syntax	:UCALibration:SLOPe? [<space> <MAX MIN DEF>]
Function	Returns the current user slope setting. This query also accepts the parameters MIN, MAX and DEF, returning the corresponding minimum, maximum, or default value for the user slope.
Example	:UCAL:SLOP MAX;SLOP? returns 2.0.

IEEE 488.2 Common Commands

The commands are listed in Table 10.

Table 10: IEEE Commands

Command	Parameter	Response	MIN	MAX
*CLS	N/A	N/A	N/A	N/A
*ESE	NRf	N/A	0	255
*ESE?	N/A	NRf		
*ESR?	N/A	NRf		
*IDN?	N/A	String		
*OPC	N/A	N/A	N/A	N/A
*OPC?	N/A	NRf		
*OPT?	N/A	String		
*RCL	NRf	N/A	0	9
*RST	N/A	N/A	N/A	N/A
*SAV	NRf	N/A	1	9
*SRE	NRf	N/A	0	255
*SRE?	N/A	NRf		
*STB?	N/A	NRf		
*TST?	N/A	N/A		
*WAI	N/A	N/A	N/A	N/A



Artisan Technology Group is your source for quality new and certified-used/pre-owned equipment

- FAST SHIPPING AND DELIVERY
- TENS OF THOUSANDS OF IN-STOCK ITEMS
- EQUIPMENT DEMOS
- HUNDREDS OF MANUFACTURERS SUPPORTED
- LEASING/MONTHLY RENTALS
- ITAR CERTIFIED SECURE ASSET SOLUTIONS

SERVICE CENTER REPAIRS

Experienced engineers and technicians on staff at our full-service, in-house repair center

*InstraView*SM REMOTE INSPECTION

Remotely inspect equipment before purchasing with our interactive website at www.instraview.com ↗

WE BUY USED EQUIPMENT

Sell your excess, underutilized, and idle used equipment. We also offer credit for buy-backs and trade-ins. www.artisanng.com/WeBuyEquipment ↗

LOOKING FOR MORE INFORMATION?

Visit us on the web at www.artisanng.com ↗ for more information on price quotations, drivers, technical specifications, manuals, and documentation

Contact us: (888) 88-SOURCE | sales@artisanng.com | www.artisanng.com