

Sorensen LH 75-5

## Benchtop Linear Power Supply



**\$350.00**

**In Stock**

**Qty Available: 1**

**Used and in Excellent Condition**

**Open Web Page**

<https://www.artisanng.com/67844-1>



Your **definitive** source  
for quality pre-owned  
equipment.

**Artisan Technology Group**

(217) 352-9330 | [sales@artisanng.com](mailto:sales@artisanng.com) | [artisanng.com](http://artisanng.com)

All trademarks, brandnames, and brands appearing herein are the property of their respective owners.

- Critical and expedited services
- In stock / Ready-to-ship
- We buy your excess, underutilized, and idle equipment
- Full-service, independent repair center

Artisan Scientific Corporation dba Artisan Technology Group is not an affiliate, representative, or authorized distributor for any manufacturer listed herein.

# **Sorensen**

---

## ***L Series Laboratory DC Power Supply***

### **Instruction Manual**

#### **LH Models:**

<b>LH 8-30</b>	<b>LH 75-5</b>
<b>LH 18-20</b>	<b>LH 110-3</b>
<b>LH 35-10</b>	<b>LH 300-1</b>
<b>LH 60-6</b>	

#### **SORENSEN**

Division of Elgar  
9250 Brown Deer Road  
San Diego, CA 92121-2294  
1-800-525-2024  
Tel: (858) 450-0085  
Fax: (858) 458-0267  
Email: [sales@sorensen.com](mailto:sales@sorensen.com)  
[www.sorensen.com](http://www.sorensen.com)

©1996 by Sorensen, Division of Elgar Electronics Corporation

This document contains information proprietary to Sorensen, division of Elgar Electronics Corporation. The information contained herein is not to be duplicated or transferred in any manner without prior written permission from Sorensen.

July 3, 1996

Document No. M360403-01 Rev A

## **SORENSEN ONE-YEAR WARRANTY**

---

Sorensen, a division of Elgar Electronics Corporation, warrants its products to be free from defects in material and workmanship. This warranty is effective for one year from the date of shipment of the product to the original purchaser. Liability of Sorensen under this warranty shall exist provided that:

- the Buyer exposes the product to normal use and service and provides normal maintenance on the product;
- Sorensen is promptly notified of defects by the Buyer and that notification occurs within the warranty period;
- the Buyer receives a Return Material Authorization (RMA) number from Sorensen's Repair Department prior to the return of the product to Sorensen for repair, phone 800-458-4258;
- the Buyer returns the defective product in the original, or equivalent, shipping container;
- if, upon examination of such product by Sorensen it is disclosed that, in fact, a defect in materials and/or workmanship does exist, that the defect in the product was not caused by improper conditions, misuse, or negligence; and,
- that Sorensen QA seal and nameplates have not been altered or removed and the equipment has not been repaired or modified by anyone other than Sorensen authorized personnel.

This warranty is exclusive and in lieu of all other warranties, expressed or implied, including, but not limited to, implied warranties of merchantability and fitness of the product to a particular purpose. Sorensen, its agents, or representatives shall in no circumstance be liable for any direct, indirect, special, penal, or consequential loss or damage of any nature resulting from the malfunction of the product. Remedies under this warranty are expressly limited to repair or replacement of the product.

### **CONDITIONS OF WARRANTY**

- To return a defective product, contact a Sorensen representative or the Sorensen factory for an RMA number. Unauthorized returns will not be accepted and will be returned at the shipper's expense.
- For Sorensen products found to be defective within thirty days of receipt by the original purchaser, Sorensen will absorb all ground freight charges for the repair. Products found defective within the warranty period, but beyond the initial thirty-day period, should be returned prepaid to Sorensen for repair. Sorensen will repair the unit and return it by ground freight pre-paid.
- Normal warranty service is performed at Sorensen during the weekday hours of 7:30 am to 4:30 pm Pacific time. Warranty repair work requested to be accomplished outside of normal working hours will be subject to Sorensen non-warranty service rates.
- Warranty field service is available on an emergency basis. Travel expenses (travel time, per diem expense, and related air fare) are the responsibility of the Buyer. A Buyer purchase order is required by Sorensen prior to scheduling.
- A returned product found, upon inspection by Sorensen, to be in specification is subject to an inspection fee and applicable freight charges.
- Equipment purchased in the United States carries only a United States warranty for which repair must be accomplished at the Sorensen factory.

# **Sorensen**

*Committed to Quality...Striving for Excellence*

## SAFETY NOTICE

### **CAUTION**

***Before applying power to the unit, verify that the ac input selector switch is set to the voltage of the ac power source; exceeding the maximum rated ac input voltage could result in damage to the unit. To avoid a fire hazard, ensure that the ac input fuse has the proper rating for the ac power source voltage.***

Before connecting the unit to the ac power source, ensure that the front panel POWER switch is in the OFF position.

### **WARNING**

***There are no operator serviceable components or adjustments within the unit. Hazardous voltages of up to 264VRMS, 373VPK may be present within the unit when the covers are removed. Only qualified service personal should service this equipment.***

Use caution when working inside the unit: Guard against risks of electrical shock during open cover checks by not touching any components, circuit boards, or test points with power applied to the unit. Even with power off, capacitors may retain an electrical charge that could be hazardous. Use safety glasses during open cover checks to avoid personal injury in case of sudden component failure.

### **WARNING**

***To prevent electrical shock, the enclosure of this unit must be connected to a safety earth ground. This is accomplished through the ground wire of the power cord. The ground terminal of the power cord must be connected to the safety ground of the ac power source. Do not remove the ground terminal of the power cord, and do not operate this unit with the enclosure ungrounded and floating.***

High energy levels can be stored at the output terminals of the power supply during normal operation; use caution to prevent shorting the output terminals. Voltages greater than 60VDC are considered dangerous; ensure that wiring and terminations going to the load are suitably insulated. Do not operate the power supply in an environment with a flammable atmosphere.

In servicing the power supply, substitution of parts or unauthorized modifications could compromise the safe operation of the unit and result in a hazardous condition.

# TABLE OF CONTENTS

SECTION	TITLE	PAGE
<b>1</b>	<b>GENERAL DESCRIPTION .....</b>	<b>1-1</b>
1.1	INTRODUCTION .....	1-1
1.2	GENERAL DESCRIPTION .....	1-1
1.3	SPECIFICATIONS .....	1-2
1.3.1	Constant-Voltage Operation .....	1-2
1.3.1.1	Output Voltage Adjustment Range .....	1-2
1.3.1.2	Output Voltage Line Regulation .....	1-2
1.3.1.3	Output Voltage Load Regulation .....	1-2
1.3.1.4	Output Voltage Temperature Coefficient ...	1-2
1.3.1.5	Output Voltage Recovery Time .....	1-2
1.3.1.6	Output Voltage Ripple and Noise .....	1-2
1.3.2	Constant-Current Operation .....	1-2
1.3.2.1	Output Current Adjustment Range .....	1-2
1.3.2.2	Output Current Line Regulation .....	1-3
1.3.2.3	Output Current Load Regulation .....	1-3
1.3.2.4	Output Ripple Current .....	1-3
1.3.3	Ac Input Characteristics .....	1-3
1.3.3.1	Ac Input Voltage Range .....	1-3
1.3.3.2	Ac Input Frequency .....	1-3
1.3.3.3	Ac Input Fuse .....	1-3
1.3.4	Mechanical Specifications .....	1-3
1.3.4.1	Dimensions .....	1-3
1.3.4.2	Weight .....	1-4
1.3.5	Environmental .....	1-4
1.3.5.1	Operating Temperature Range .....	1-4
1.3.5.2	Storage Temperature Range .....	1-4

Table of Contents

SECTION	TITLE	PAGE
	1.3.5.3 Humidity .....	1-4
1.3.6	General Characteristics .....	1-4
	1.3.6.1 Display Type .....	1-4
	1.3.6.2 Display Accuracy .....	1-4
	1.3.6.3 Display Voltage Range .....	1-4
	1.3.6.4 Display Current Range .....	1-4
<b>2</b>	<b>INSTALLATION .....</b>	<b>2-1</b>
2.1	Introduction .....	2-1
2.2	Initial Inspection .....	2-1
2.3	Physical Inspection .....	2-1
2.4	Location of Application .....	2-1
2.5	Input Power Requirements .....	2-2
2.6	Ac Line Voltage Selection .....	2-3
2.7	Ac Line Fuse .....	2-3
2.8	Load Connections .....	2-3
	2.8.1 Load Wiring .....	2-3
	2.8.2 Wire Current Carrying Capacity .....	2-3
	2.8.3 Wire Voltage Drop .....	2-4
	2.8.4 Noise and Impedance Effects .....	2-5
2.9	Load Connection Configurations .....	2-5
	2.9.1 Connecting Single Loads .....	2-5
	2.9.2 Connecting Multiple Loads .....	2-5
	2.9.3 Remote Sensing .....	2-7
	2.9.4 Connecting the Remote Sense Leads .....	2-7
<b>3</b>	<b>OPERATION .....</b>	<b>3-1</b>
3.1	Introduction .....	3-1
3.2	Controls, Indicators, and Connectors .....	3-1
3.3	Front Panel .....	3-3
3.4	Rear Panel .....	3-3
3.5	Initial Functional Tests .....	3-4
	3.5.1 Power-On Check .....	3-4
	3.5.2 Constant-Voltage Mode Operation Check .....	3-5
	3.5.3 Constant-Current Mode Operation Check .....	3-5
3.6	Operation Set-Up .....	3-6
	3.6.1 Constant-Voltage Mode of Operation .....	3-7
	3.6.2 Constant-Current Mode of Operation .....	3-7
	3.6.3 Adjustment of Constant-Voltage Operation .....	3-7
	3.6.4 Adjustment of Constant-Current Operation .....	3-8

SECTION	TITLE	PAGE
	3.6.5 Series Operation of Multiple Supplies .....	3-9
3.7	Reverse Polarity Protection .....	3-9
3.8	Battery Charging .....	3-9
<b>4</b>	<b>MAINTENANCE</b> .....	<b>4-1</b>
4.1	General Servicing .....	4-1
	4.1.1 AC LINE SELECT Switch Settings .....	4-1
	4.1.2 Ac Line Cord Test .....	4-1
	4.1.3 Ac Line Fuse Test .....	4-2
	4.1.4 Cleaning .....	4-2
4.2	Calibration .....	4-2
	4.2.1 Output Voltage Zero Adjustment .....	4-2
	4.2.2 Output Voltage Range Adjustment .....	4-3
	4.2.3 Voltage Display Adjustment .....	4-3
	4.2.4 Output Current Range Adjustment .....	4-3
	4.2.5 Current Display Adjustment .....	4-5
4.3	Factory Service Information .....	4-5

## LIST OF FIGURES

FIGURE	TITLE	PAGE
2-1	Rear Panel Ac Switches, Fuse, and Connector .....	2-2
2-2	Single Load Connection .....	2-6
2-3	Multiple Load Connection .....	2-6
2-4	Single Load Connection with Load Sensing .....	2-7
3-1	Front Panel Controls and Indicators .....	3-1
3-2	Rear Panel for LH 8-30 and LH 18-20 .....	3-2
3-3	Rear Panel for LH 35-10, LH 60-6, LH 75-5, and LH 110-3 .....	3-2
3-4	CV and CC Mode of Operation .....	3-6
4-1	Control Board Potentiometer Locations .....	4-3
4-2	Display Board Potentiometer Locations .....	4-4

## LIST OF TABLES

TABLE	TITLE	PAGE
3-1	Wire Data .....	2-4



# SECTION 1

## GENERAL DESCRIPTION

### 1.1 INTRODUCTION

The LH Models comprise a family of Laboratory Power Supplies designed for benchtop and portable applications. The family consists of seven models encompassing voltage outputs from 8V to 300V and current outputs from 1A to 30A. These power supplies are manually adjusted, and could be operated as variable voltage sources or current sources.

### 1.2 GENERAL DESCRIPTION

These power supplies utilize linear series-pass output stages to provide enhanced performance characteristics such as excellent regulation (0.01%), low noise (1mV), and fast transient response (100 $\mu$ s). They could be operated as precisely regulated voltage sources in constant-voltage (CV) mode or current sources in constant-current (CC) mode. Crossover between modes is automatic, being dependent on load demand.

Front panel controls are provided to adjust the voltage and current from 0 to 100% of rating. Coarse and fine controls for both voltage and current facilitate accurate setting of the output. 3-1/2 digit LED displays are provided to simultaneously display the output voltage and current. Also, front panel CV and CC indicators allow determination of whether the power supply is operating in constant-voltage or constant-current mode.

The output is isolated from the chassis. This allows operation with a floating output, or with either the positive or negative lead referenced to chassis ground; also, units could be connected in series to increase the output voltage. The output is fully protected for overload, short-circuit, and reverse polarity.

The LH 8-30 and LH 18-30 have the capability of remote sensing of the output voltage for compensation of line drop in the output connections. Also, they feature rear panel terminal blocks for connecting loads greater than 10A. They retain the convenience of front panel binding posts for connecting loads up to 10A.

## 1.3 SPECIFICATIONS

### 1.3.1 Constant Voltage Operation

#### 1.3.1.1 Output Voltage Adjustment Range

LH 8-30	0 to 8VDC
LH 18-20	0 to 18VDC
LH 35-10	0 to 35VDC
LH 60-6	0 to 60VDC
LH 75-5	0 to 75VDC
LH 110-3	0 to 110VDC
LH 300-1	0 to 300VDC

#### 1.3.1.2 Output Voltage Line Regulation

$\leq 0.01\% + 3\text{mV}$

#### 1.3.1.3 Output Voltage Load Regulation

$\leq 0.01\% + 5\text{mV}$  for LH 60-6, LH 75-5, LH 110-3, LH 300-1  
 $\leq 0.02\% + 5\text{mV}$  for LH 8-30, LH 18-20, LH 35-10

#### 1.3.1.4 Output Voltage Temperature Coefficient

$\leq 300\text{PPM}/^\circ\text{C}$

#### 1.3.1.5 Output Voltage Recovery Time

$\leq 100\mu\text{s}$  for 50% load change, 0.5A minimum load

#### 1.3.1.6 Output Voltage Ripple and Noise

$\leq 1\text{mV(RMS)}$ , measured with a bandwidth of 5Hz to 1MHz

### 1.3.2 Constant Current Operation

#### 1.3.2.1 Output Current Adjustment Range

LH 8-30	0 to 30ADC
LH 18-20	0 to 20ADC
LH 35-10	0 to 10ADC
LH 60-6	0 to 6ADC

LH 75-5      0 to 5ADC  
LH 110-3     0 to 3ADC  
LH 300-1     0 to 1ADC

### 1.3.2.2      **Output Current Line Regulation**

$\leq 0.2\% + 3\text{mA}$

### 1.3.2.3      **Output Current Load Regulation**

$\leq 0.2\% + 5\text{mA}$

### 1.3.2.4      **Output Ripple Current**

$\leq 5\text{mA(RMS)}$ , except  $\leq 10\text{mA(RMS)}$  for LH 8-30

## 1.3.3        **Ac Input Characteristics**

### 1.3.3.1      **Ac Input Voltage Range**

100V/120V/220V/240V  $\pm 10\%$ , switch selectable

### 1.3.3.2      **Ac Input Frequency**

50Hz or 60Hz

### 1.3.3.3      **Ac Input Fuse**

LH 8-30, LH 18-20, LH 35-10, LH 60-6, LH 75-5:

T10A/250VAC, time-delay, for 100/120VAC operation

T8A/250VAC, time-delay, for 220/240VAC operation

LH 110-3, LH 300-1:

T8A/250VAC, time-delay, for 100/120VAC operation

T4A/250VAC, time-delay, for 220/240VAC operation

## 1.3.4        **Mechanical Specifications**

### 1.3.4.1      **Dimensions**

255mm(W)  $\times$  145mm(H)  $\times$  420mm(D) (10.0"W  $\times$  5.7"H  $\times$  16.5"D)

**1.3.4.2 Weight**

18.5Kg (40.8lb) for LH 8-30, LH 18-20, LH 35-10, LH 60-6, LH 75-5  
13.5Kg (29.8lb) for LH 110-3, LH 300-1

**1.3.5 Environmental**

**1.3.5.1 Operating Temperature Range**

0°C to 40°C

**1.3.5.2 Storage Temperature Range**

-10°C to 70°C

**1.3.5.3 Humidity**

< 80%, operating; < 70%, storage

**1.3.6 General Characteristics**

**1.3.6.1 Display Type**

Digital, 3.5 digits, 0.5" red LED

**1.3.6.2 Display Accuracy**

±(0.5% of reading + 2 digits)

**1.3.6.3 Display Voltage Range**

19.99V for full scale in LH 8-30, LH 18-20  
199.9V for full scale in LH 35-10, LH 60-6, LH 75-5, LH 110-3  
1999V for full scale in LH 300-1

**1.3.6.4 Display Current Range**

199.9A for full scale in LH 8-30, LH 18-20  
19.99A for full scale in LH 35-10, LH 60-6, LH 75-5, LH 110-3  
1.999A for full scale in LH 300-1

## **SECTION 2 INSTALLATION**

### **2.1 INTRODUCTION**

The LH Model Laboratory Power Supply has been fully calibrated and tested prior to shipment. Therefore, the unit is ready for immediate use upon receipt. However, when first unpacked, the unit should be inspected to ensure that no shipping damage had occurred.

### **2.2 INITIAL INSPECTION**

Perform a visual inspection of the shipping container prior to accepting the package from the carrier. If extensive damage to the shipping container is evident, a description of the damage should be noted on the carrier's receipt and signed by the driver of the carrier's agent.

If damage is not apparent until the unit is unpacked, a claim for concealed damage should be placed with the carrier. In addition, the shipping container and filler material should be saved for inspection. Forward a report of the damage to the Sorensen Service Department. Sorensen will provide instructions for repair or replacement of the unit.

### **2.3 PHYSICAL INSPECTION**

Perform a visual inspection of the unit after it is removed from the shipping container. Check for shipping damage such as dents, scratches, distortion of the enclosure, or damaged controls. If external damage is evident, remove the cover and also check for internal damage to circuit boards or components.

### **2.4 LOCATION OF APPLICATION**

The unit is designed for benchtop and portable applications. Since it is fan-cooled, it requires adequate clearance at the air intake and exhaust so that air flow is not impeded. The air intake is at the rear of the unit, and the air exhaust is from the perforations in the cover. The temperature of the intake air should not exceed 40°C.

## 2.5 INPUT POWER REQUIREMENTS

The unit will operate from an ac power source rated at 100/120/220/240VAC,  $\pm 10\%$  at 50/60Hz. Before connecting to the ac power source, ensure that the AC LINE SELECT switches on the rear panel are set for the available voltage, and that the fuse rating is appropriate for the voltage selected. Refer to Figure 2-1 for the location of the AC LINE SELECT switches and the ac line fuse.

### **CAUTION**

***Exceeding the maximum rated ac input voltage could result in damage to the unit. Operating with a fuse of improper rating could result in a fire hazard.***

An IEC connector is provided on the rear panel for connecting the unit to the ac power source with a power cord; the IEC connector also provides the safety ground termination. The power cord supplied with the unit has a safety ground wire that connects the enclosure of the unit to the safety ground of the ac power source. This connection is automatically made when the power cord is plugged into an appropriate ac receptacle.

### **WARNING**

***Operating the unit with the safety ground wire of the power cord disconnected could result in a shock hazard.***

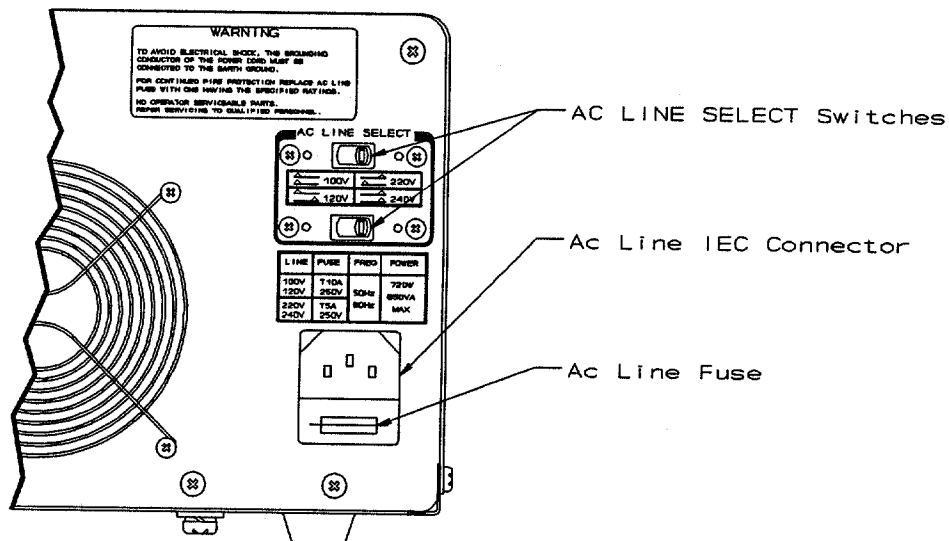

**Figure 2-1. Rear Panel Ac Switches, Fuse, and Connector**

## 2.6 AC LINE VOLTAGE SELECTION

Determine the nominal voltage rating of the ac power source: either 100VAC, 120VAC, 220VAC, or 240VAC. Refer to Figure 2-1 for the positions of the AC LINE SELECT switches required to select one of the four nominal values.

### **CAUTION**

***To prevent damage to the unit, disconnect the ac power cord before changing the settings of the AC LINE SELECT switches on the rear panel.***

## 2.7 AC LINE FUSE

Check that the fuse installed in the fuse holder has the proper rating for the ac power source voltage. To extract the fuse, snap out the plastic panel that holds the fuse in the fuse holder. The fuse ratings are listed in Subsection 1.3.3.3, AC INPUT FUSE, and also in a table on the rear panel of the unit. Refer to Figure 2-1 for the location of the table.

### **WARNING**

***To prevent electrical shock, disconnect the ac power cord before checking the fuse.***

## 2.8 LOAD CONNECTIONS

### 2.8.1 Load Wiring

When connecting the load to the power supply, the following factors must be considered when selecting a suitable wire gauge:

1. The current carrying capacity of the wire (limited by temperature rise of the wire)
2. The voltage drop across the total length of load lines
3. Noise coupling and impedance effects of the load lines

### 2.8.2 Wire Current Carrying Capacity

Load wiring must have a current carrying capacity greater than the output current rating of the power supply. This ensures that the wiring will not be damaged even if the load is shorted. Table 3-1 shows the maximum current rating, based on  $450\text{A}/\text{cm}^2$ , for various gauges of wire rated for  $105^\circ\text{C}$  operation. Operation at the maximum current rating results in approximately a  $30^\circ\text{C}$  temperature rise for a wire operating in free air. When load wiring must operate in

areas with elevated ambient temperature or bundled with other wiring, larger gauges or higher temperature-rated wiring should be used.

AWG	Copper Area cm <sup>2</sup>	Resistance Ω/m, at 20°C	Resistance Ω/m, at 100°C	Current Rating A, at 450A/cm <sup>2</sup>
6	0.13301	0.0013	0.0017	59.9
8	0.08368	0.0021	0.0028	37.7
10	0.05262	0.0033	0.0044	23.7
12	0.03309	0.0052	0.0069	14.9
14	0.02081	0.0083	0.0110	9.4
16	0.01309	0.0132	0.0174	5.9
18	0.00823	0.0209	0.0276	3.7
20	0.00518	0.0333	0.0440	2.3
22	0.00326	0.0530	0.0700	1.5

Table 3-1. Wire Data

### 2.8.3 Wire Voltage Drop

For applications where regulation is important, the contribution of the load wiring to voltage drop from the power supply output terminals to the load must be considered. The wire gauge must be selected to maintain an acceptable total voltage drop of the load wiring under the maximum peak current. The resistance of the load wiring must be determined for the sum total length of the positive lead and the negative lead. Table 3-1 gives the resistance per meter (m) of various wire gauges at 20°C and 100°C. The following equation could be used to calculate the resistance for other wire temperatures:

$$R = R_{20^{\circ}\text{C}} \times [1 + 0.004 \times (T - 20^{\circ}\text{C})]$$

where

- R = resistance, Ω/m, at temperature T
- $R_{20^{\circ}\text{C}}$  = resistance, Ω/m, at 20°C
- T = temperature, °C, of wire

The voltage drop (per positive or negative lead) could be calculated using the following equation:

$$V = I \times L \times R_{20^{\circ}\text{C}} \times [1 + 0.004 \times (T - 20^{\circ}\text{C})]$$



where

- V = total voltage drop, V
- I = load current, A
- L = length, m, of load wire
- $R_{20^{\circ}\text{C}}$  = resistance,  $\Omega/\text{m}$ , of wire at  $20^{\circ}\text{C}$
- T = temperature,  $^{\circ}\text{C}$ , of wire conducting load current

The total voltage drop would be calculated by summing the voltage drops of the positive and negative leads.

### 2.8.4 Noise and Impedance Effects

To minimize noise pickup or radiation from load circuits, load wires should be shielded twisted-pair with minimum lead length. Connect the shield only to the chassis of the power supply using the GND terminals. Even when shielding is impractical, the load wires should be twisted together to reduce noise coupling. When regulation is important, the wire gauge should be the largest practical and the wires should be twisted together to reduce their impedance.

## 2.9 LOAD CONNECTION CONFIGURATIONS

Both the positive and negative outputs of the power supply are isolated with respect to chassis ground. Either the positive or negative terminals could be connected to the chassis ground. Also, either the positive or negative leads could be floated up to 300VPK with respect to chassis ground.

### **CAUTION**

***Operating the power supply with either the positive or negative output lead floated greater than 300VPK above chassis ground could result in damage to the unit.***

#### 2.9.1 Connecting Single Loads

Single loads should be connected with the largest gauge and the shortest length wire that is possible. On power supplies without remote sensing, the output voltage will be precisely regulated at the output terminals of the unit. On models LH 8-30 and LH 18-20, remote sensing could be used to move the location of precise regulation to the load terminals or an intermediate distribution point. Refer to Figure 2-2.

#### 2.9.2 Connecting Multiple Loads

When output voltage regulation is critical and multiple loads are connected to the power supply, it is important to connect each load independently to the power supply terminals where the output voltage is sensed. Independent leads to each load will ensure that the load currents do

not produce voltage drops in the connecting leads that could be mutually coupled between the loads. The connecting wires should be of the largest gauge and shortest length possible.

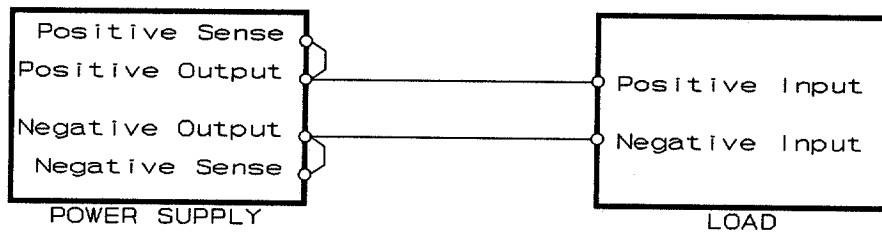

**Figure 2-2. Single Load Connection**

In models without remote sensing, the output voltage is sensed at the front panel terminals; therefore, the loads should be connected independently to those terminals. In models LH 8-30 and LH 18-20, remote sensing allows relocation of the point of voltage sensing. In the default position the sense leads are connected to the rear panel terminal block. The front panel terminals could be used with currents up to 10A, but with higher voltage regulation. Refer to Figure 2-3.

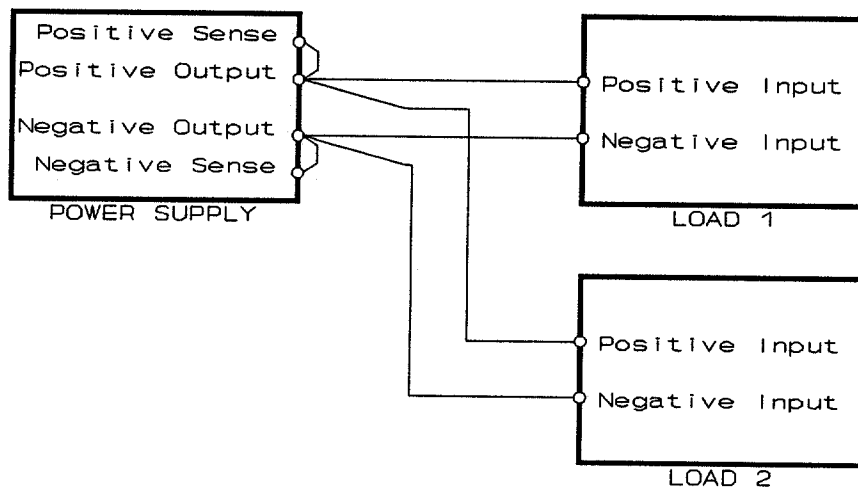

**Figure 2-3. Multiple Load Connection**

### 2.9.3 Remote Sensing

Remote sensing is available in models LH 8-30 and LH 18-20. Remote sensing is used during voltage-mode operation to compensate for voltage drop in the leads connecting the load to the power supply output. The power supply will maintain precise regulation at those terminals to which the sense leads are connected. This could be at the power supply output terminals (the default location) or at the load terminals if separate sense leads are connected from the rear panel terminal block sense terminals (jumpers from the sense terminals to the output terminals must be removed) to the load terminals. Refer to Figure 2-4.

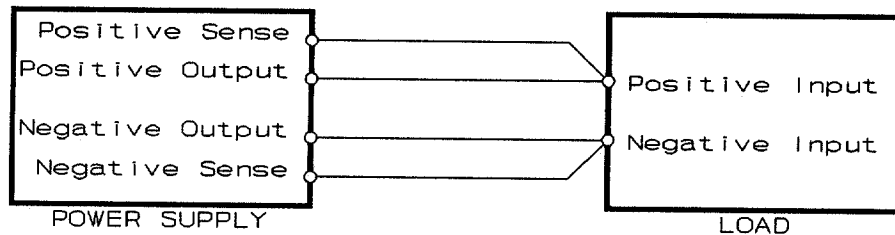

Figure 2-4. Single Load Connection with Remote Sensing

### 2.9.4 Connecting the Remote Sense Leads

To connect the remote sense leads of models LH 8-30 and LH 18-20, the following procedure should be used:

1. Ensure that the front panel POWER switch is in the OFF position. Allow five minutes to elapse to allow discharge of stored energy before altering the rear panel output terminal block connections.
2. Remove the local sense jumpers between the terminal block positions "S+" to "OUT+" and "S-" and "OUT-".
3. Connect a sense lead from "S+" to the point where the positive output voltage is to be monitored. Connect a sense lead from "S-" to the point where the negative output voltage is to be monitored. Use shielded twisted-pair wiring of 24AWG or larger for the sense leads.

4. Ground the shield of the sense leads at one point only, preferably to the power supply chassis GND terminal.
5. Turn the front panel POWER switch to the ON position. Ensure that the output voltage is in regulation.

**CAUTION**

***Do not use remote sensing when multiple power supplies are connected in series.***

## SECTION 3 OPERATION

### 3.1 INTRODUCTION

The LH Model Laboratory Power Supply has a full complement of controls, indicators, and connectors that allow the user to easily install, setup, and operate the unit.

### 3.2 CONTROLS, INDICATORS, AND CONNECTORS

Refer to Figure 3-1 for an illustration of the front panel, Figure 3-2 for the rear panel of models LH 8-30 and LH 18-20, and Figure 3-3 for the rear panel of models LH 35-10, LH 60-6, LH 75-5, and LH 110-3.

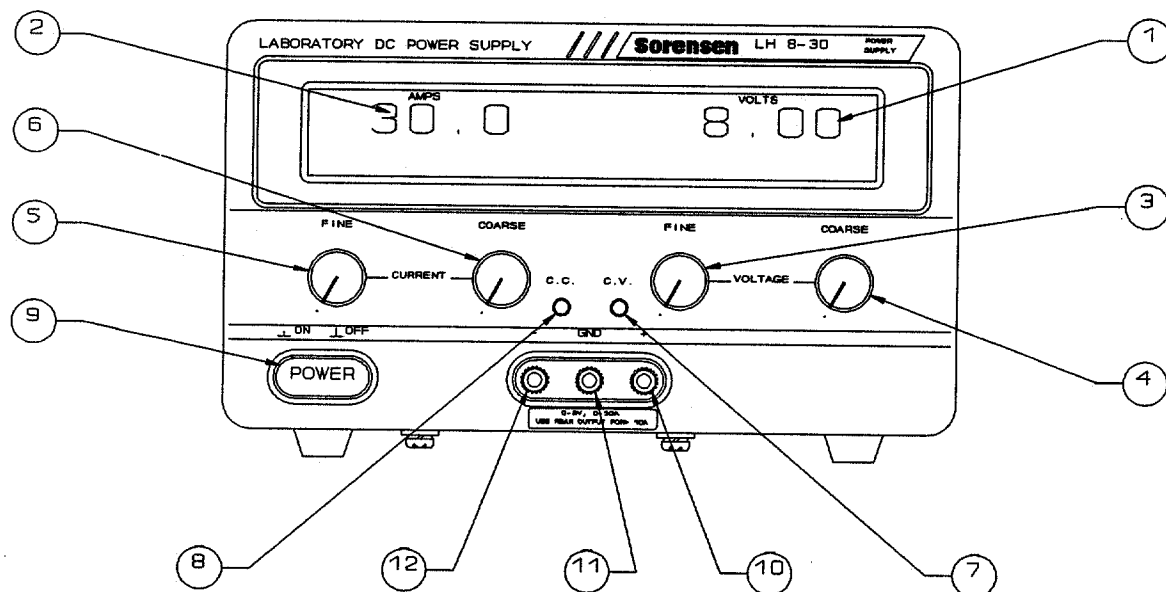

Figure 3-1. Front Panel Controls and Indicators

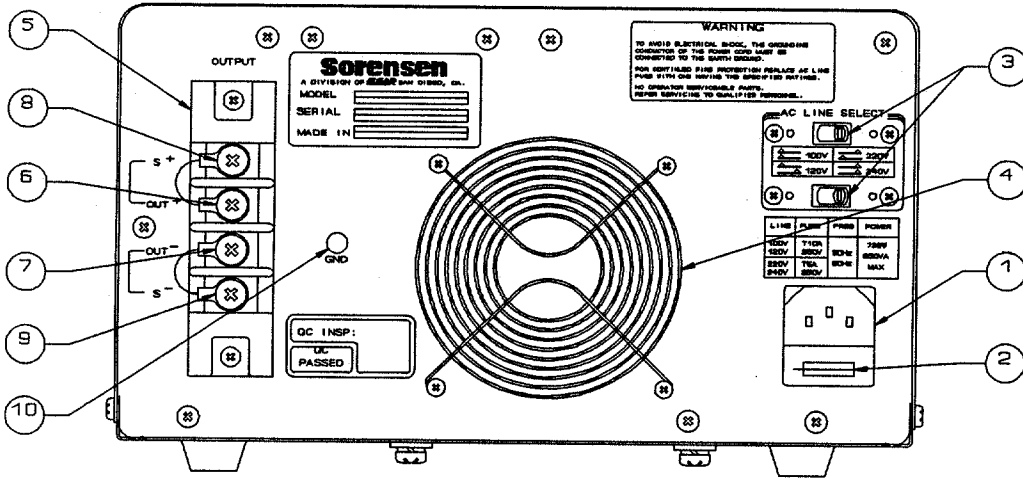

Figure 3-2. Rear Panel for LH 8-30 and LH 18-20

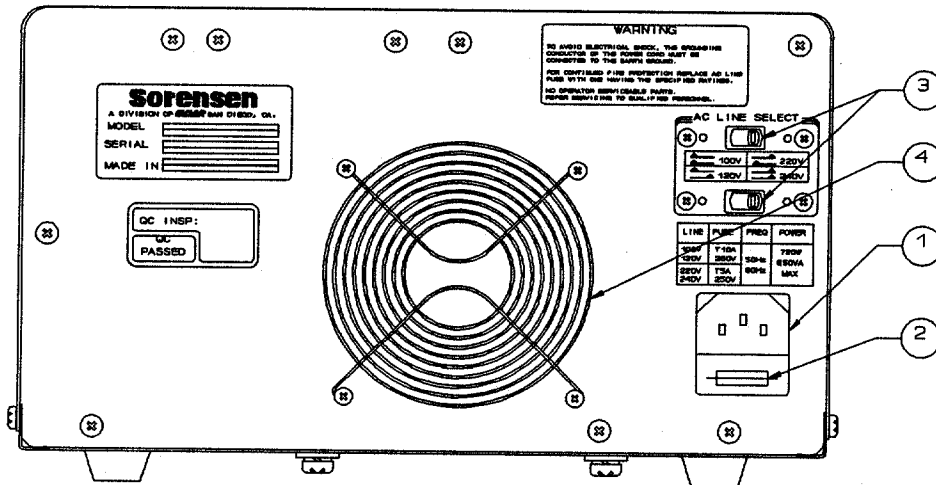

Figure 3-3. Rear Panel for LH 35-10, LH 60-6, LH 75-5, and LH 110-3

### 3.3 FRONT PANEL

Refer to Figure 3-1 for the location of controls and indicators.

1. **VOLTAGE DISPLAY:** Indicates the value of the output voltage.
2. **CURRENT DISPLAY:** Indicates the value of the output current.
3. **VOLTAGE FINE CONTROL:** Provides a fine adjustment of the output voltage.
4. **VOLTAGE COARSE CONTROL:** Provides a coarse adjustment of the output voltage.
5. **CURRENT FINE CONTROL:** Provides a fine adjustment of the output current.
6. **CURRENT COARSE CONTROL:** Provides a coarse adjustment of the output current.
7. **CV INDICATOR:** Indicates that the output is in constant-voltage mode. The output voltage is being regulated, and the output current could vary.
8. **CC INDICATOR:** Indicates that the output is in constant-current mode. The output current is being regulated, and the output voltage could vary.
9. **POWER SWITCH:** Turns the unit ON and OFF.
10. **POSITIVE OUTPUT TERMINAL:** Connects to the positive output. Colored red and labeled "+". This terminal is limited to 10A, maximum. On models LH 8-30 and LH 18-20, use the rear panel terminal block for load current greater than 10A.
11. **NEGATIVE OUTPUT TERMINAL:** Connects to the negative output. Colored black and labeled "-". This terminal is limited to 10A, maximum. On models LH 8-30 and LH 18-20, use the rear panel terminal block for load current greater than 10A.
12. **CHASSIS GROUND TERMINAL:** Connects to the chassis ground. Colored green and labeled "GND".

### 3.4 REAR PANEL

Refer to Figures 3-2 and 3-3 for the location of controls and connectors.

1. **AC LINE INPUT:** IEC connector for the ac input power cord.
2. **AC LINE FUSE HOLDER:** Contains the ac input fuse. The fuse is located on

- a plastic panel that snaps into the body of the fuse holder.
3. **AC LINE SELECT SWITCHES:** Two switches that convert the operation of the unit for 100/120/220/240VAC ac power sources.
  4. **AIR INTAKE:** Air intake for cooling fan.
  5. **OUTPUT TERMINAL BLOCK:** On models LH 8-30 and LH 18-20 only, provides output terminals for loads greater than 10A and terminations for remote sensing.
  6. **POSITIVE OUTPUT TERMINAL:** On models LH 8-30 and LH 18-20 only, connects to the positive output, labeled "OUT +". Also connected internally to the front panel positive terminal.
  7. **NEGATIVE OUTPUT TERMINAL:** On models LH 8-30 and LH 18-20 only, connects to the negative output, labeled "OUT -". Also connected internally to the front panel negative terminal.
  8. **POSITIVE REMOTE SENSING TERMINAL:** On models LH 8-30 and LH 18-20 only, terminal for monitoring the positive output voltage for line drop compensation, labeled "SENSE +".
  9. **NEGATIVE REMOTE SENSING TERMINAL:** On models LH 8-30 and LH 18-20 only, terminal for monitoring the negative output voltage for line drop compensation, labeled "SENSE -".
  10. **CHASSIS GROUND TERMINAL:** On models LH 8-30 and LH 18-20 only, connects to the chassis ground, labeled "GND".

### **3.5 INITIAL FUNCTIONAL TESTS**

#### **3.5.1 Power-On Check**

1. Ensure that the front panel POWER switch is in the OFF position (switch button out).
2. Turn the COARSE and FINE controls for the VOLTAGE and CURRENT fully counter-clockwise.
3. Connect the power cord to an ac power source that matches the voltage setting of the rear panel AC LINE SELECT switches.
4. Turn the front panel POWER switch to the ON position (switch button in).

3-4



5. Ensure that the front panel digital displays are on and that both the VOLTAGE and CURRENT displays indicate zero. Also, the CV indicator should be illuminated.

### 3.5.2 Constant-Voltage Mode Operation Check

1. Ensure that the front panel POWER switch is in the OFF position (switch button out).
2. Turn the VOLTAGE and CURRENT controls on the front panel fully counter-clockwise.
3. Connect a digital voltmeter (DVM) to the output terminals on the front panel, observing the correct polarity. The DVM must have better than 0.1% accuracy.
4. Turn the COARSE control for the CURRENT 1/2 turn clockwise.
5. Turn the front panel POWER switch to the ON position (switch button in).
6. Slowly turn the COARSE control for the VOLTAGE clockwise and observe the values of the VOLTAGE display and the DVM. Adjust the COARSE and FINE controls for the VOLTAGE across their full ranges.
7. Compare the DVM reading with the front panel display reading to verify the accuracy of the front panel display for VOLTAGE.
8. Ensure that the controls for VOLTAGE adjust the output voltage across the full rated voltage range. Also, the CV indicator should be illuminated, and the CC indicator should be off.

### 3.5.3 Constant-Current Mode Operation Check

1. Ensure that the front panel POWER switch is in the OFF position (switch button out).
2. Turn the VOLTAGE and CURRENT controls on the front panel fully counter-clockwise.
3. Turn the COARSE control for the VOLTAGE 1/4 turn clockwise.
4. Connect a dc shunt across the output terminals on the front panel; on models LH 8-30 and LH 18-20, use the rear panel terminal block for current greater than 10A. Ensure that the rating of the dc shunt and the wire exceed the output current capability of the power supply.

5. Connect a digital voltmeter (DVM) across the dc shunt, observing the correct polarity. The combined accuracy of the DVM and dc shunt must be better than 0.1%.
6. Turn the front panel POWER switch to the ON position (switch button in).
7. Turn the COARSE control for the CURRENT slowly clockwise and observe the values of the CURRENT display and the DVM. Adjust the COARSE and FINE controls for the CURRENT across their full ranges.
8. Compare the DVM reading with the front panel display reading to verify the accuracy of the front panel display for CURRENT. The DVM reading must be converted to current by multiplying the DVM reading by a conversion factor equal to the dc current rating of the shunt divided by the burden voltage rating of the shunt.
9. Ensure that the controls for CURRENT adjust the output current across the full rated current range. Also, the CC indicator should be illuminated, and the CV indicator should be off.

### 3.6 OPERATION SET-UP

The power supply is capable of operating in constant-voltage or constant-current mode. The mode of operation is dependent on the settings of the VOLTAGE and CURRENT controls and resistance of the load. The power supply could automatically crossover between the two modes of operation in response to load demands. The mode of operation is indicated with front panel LED's: CV for constant-voltage and CC for constant-current. Refer to Figure 3-4.

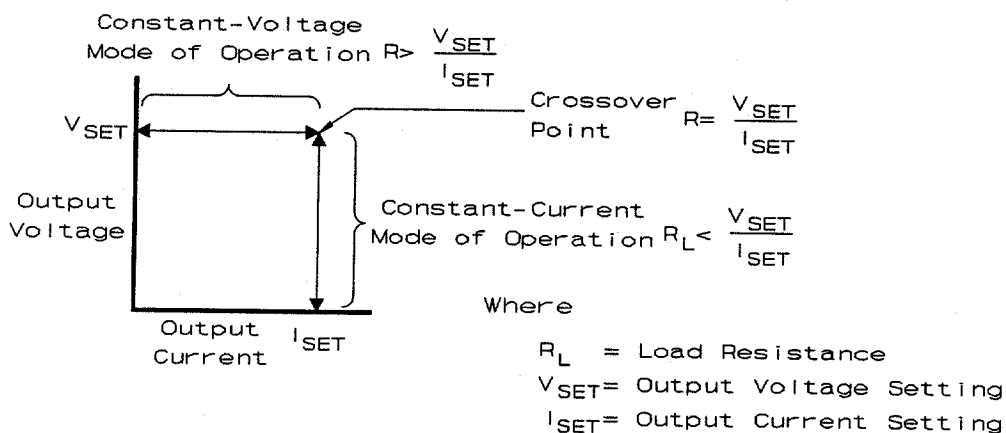

Figure 3-4. CV and CC Mode of Operation

### 3.6.1 Constant-Voltage Mode of Operation

The power supply will operate in constant-voltage mode whenever the load current is less than the current setting. (Note that the load current is equal to the output voltage divided by the load resistance.) In this mode, the power supply maintains the output voltage precisely regulated to the voltage setting while the load current varies with the load requirements. This condition would be maintained as long as the load current is less than the current setting. If the load resistance decreases to where the load current attempts to exceed the current setting, the output current would be regulated at the set value and the output voltage would then decrease. This is the automatic crossover to constant-current mode of operation.

### 3.6.2 Constant-Current Mode of Operation

The power supply will operate in constant-current mode whenever the load resistance times the current limit setting is less than the voltage setting. In this mode, the power supply maintains the output current precisely regulated to the current setting while the load voltage varies with load requirements. This condition would be maintained as long as the load resistance is less than the voltage setting divided by the current setting. If the load resistance increases to where the load voltage attempts to exceed the voltage setting, the output voltage would be regulated to the set value and the output current would then decrease. This is the automatic crossover to constant-voltage mode of operation.

### 3.6.3 Adjustment of Constant-Voltage Operation

Use the following procedure to adjust the power supply for constant-voltage mode of operation:

1. Turn the front panel POWER switch to the ON position.
2. Adjust the VOLTAGE controls to the desired voltage setting. The CV indicator should be illuminated.
3. Turn the front panel POWER switch to the OFF position.
4. Turn the front panel CURRENT controls to fully counter-clockwise.
5. Short the positive and negative output terminals. Ensure that the jumper could safely conduct the maximum output current of the power supply. On models LH 8-30 and LH 18-20, use the rear panel terminal block for output current greater than 10A.
6. Turn the front panel POWER switch to the ON position.
7. Adjust the CURRENT controls to the desired current limit value as would be determined by the load. The CC indicator should be illuminated.

The current limit must be greater than the maximum peak current required by the load. If the load current attempts to exceed the limit value, the power supply will enter the constant-current mode of operation: The output voltage will decrease and will no longer be regulated.

8. Turn the front panel POWER switch to the OFF position. Remove the shorting jumper from the output terminals, and connect the load.
9. Turn the front panel POWER switch to the ON position.

#### **3.6.4 Adjustment of Constant-Current Operation**

Use the following procedure to adjust the power supply for constant-current mode of operation:

1. Turn the front panel POWER switch to the ON position.
2. Adjust the VOLTAGE controls to the desired voltage limit value as determined by the load. The CV indicator should be illuminated.

The voltage limit must be greater than the maximum voltage drop required by the load while conducting the desired output current. If the load voltage attempts to exceed the limit value (resulting from a load resistance increase), the power supply will enter the constant-voltage mode of operation: The output current will decrease and will no longer be regulated.

3. Turn the front panel POWER switch to the OFF position.
4. Turn the front panel CURRENT controls to fully counter-clockwise.
5. Short the positive and negative output terminals. Ensure that the jumper could safely conduct the maximum output current of the power supply. On models LH 8-30 and LH 18-20, use the rear panel terminal block for output current greater than 10A.
6. Turn the front panel POWER switch to the ON position.
7. Adjust the CURRENT controls to the desired current setting. The CC indicator should be illuminated.
8. Turn the front panel POWER switch to the OFF position. Remove the shorting jumper from the output terminals, and connect the load.
9. Turn the front panel POWER switch to the ON position.

### 3.6.5 Series Operation of Multiple Supplies

Power supplies of the SAME MODEL may be operated with their outputs connected in series to increase the output voltage. Connect the negative output terminal of the first power supply to the positive terminal of the next supply; continue interconnecting the remaining supplies in the same manner. The output voltage is obtained from the positive terminal of the first supply and the negative terminal of the last supply. The total voltage available is the sum of the maximum voltages of each power supply. The maximum current available is the current rating of a single supply in the series string.

#### **CAUTION**

***The maximum allowable sum of output voltages is 300VDC. Do not use remote sensing when operating power supplies in series.***

### 3.7 REVERSE POLARITY PROTECTION

The output of the power supply is protected against reverse polarity sources connected to the output terminals. The output terminals have a diode connected directly across them such that it is normally reversed-biased. If the voltage at the output terminals were to reverse in polarity, the diode would conduct and clamp it to its forward voltage drop.

#### **CAUTION**

***Connecting a voltage source of reversed polarity to the output terminals could result in damage to the unit if the resulting current exceeds the current capabilities of the reverse polarity protection diode.***

### 3.8 BATTERY CHARGING

When using a power supply to charge a battery, the following precautions should be taken:

1. Connect an isolation diode in series with one of the output terminals of the power supply. This diode will prevent discharge of the battery if the power supply were to be turned off. The diode must have suitable current and voltage ratings and should be mounted on an appropriate heatsink.
2. Adjust the VOLTAGE setting to the desired float voltage with the power supply disconnected from the battery. The VOLTAGE setting should compensate for the voltage drop of the isolation diode.
3. Adjust the CURRENT setting to the desired current limit value when charging a battery.

When recharging a battery, the power supply will initially operate in constant-current mode, regulating the output current to the current limit value. As the battery charges the battery voltage would increase until the float voltage setting is reached.

The power supply would then enter the constant-voltage mode of operation, regulating the output voltage at the float voltage setting. The battery current would then decrease from the current limit setting and eventually drop to a low float current level when the battery is fully charged.

## SECTION 4 MAINTENANCE

### **WARNING**

***Servicing should be performed only by qualified personal. Operator personal should not remove the enclosure top cover. Follow the safety precautions listed in Section SAFETY NOTICE at the beginning of this manual.***

### **4.1 GENERAL SERVICING**

If the power supply appears to be operating improperly, determine whether the power supply or the load is the cause by performing the tests presented in Subsection 3.5, INITIAL FUNCTIONAL TESTS: POWER-ON CHECK, CONSTANT-VOLTAGE MODE OPERATION CHECK, OR CONSTANT-CURRENT MODE OPERATION CHECK.

If the power supply fails to operate, and the front panel displays (VOLTAGE and CURRENT) and indicators (CV or CC) are not illuminated, perform the basic tests of Subsections 4.1.1 through 4.1.3.

#### **4.1.1 AC LINE SELECT Switch Settings**

Ensure that the rear panel AC LINE SELECT switches are set for the available ac power source voltage. Refer to Subsection 2.6, AC LINE VOLTAGE SELECTION, for instructions on how to change the switch settings.

#### **4.1.2 Ac Line Cord Test**

Determine the condition of the ac power cord by measuring with an ohmmeter the resistance of the connections between the plug and connector. Ensure that continuity exists between corresponding supply and ground terminals of the plug and connector. Replace a cord that measures a high resistance or open circuit, or that has a damaged cable, plug, or connector.

### 4.1.3 Ac Line Fuse Test

Ensure that the ac input fuse has the proper rating. Refer to Subsection 2.7, AC LINE FUSE, for instructions on how to remove the ac input fuse. If the fuse rating is correct, determine whether the fuse is open by measuring with an ohmmeter the resistance of the fuse. Replace an open fuse only with one of the proper rating. If the fuse is replaced and opens again, there is a problem internal to the unit that would require servicing by a qualified personal.

### 4.1.4 Cleaning

The exterior of the unit should be cleaned with a mild solution of detergent and water. The solution should be applied onto a soft cloth, and not directly to the surface of the unit. To prevent damage to materials, do not use aromatic hydrocarbons or chlorinated solvents for cleaning.

## 4.2 CALIBRATION

### **WARNING**

***The calibration procedures are performed with the power supply top cover removed and the power on. Adjustment potentiometers are located in circuits that are connected to potentially lethal voltages. Use insulated tools when making adjustments to circuit potentiometers, and do not touch any components or circuits. To prevent personal injury, following the safety precautions listed in Section SAFETY NOTICE in the beginning of this manual.***

The power supply has been fully calibrated prior to shipment. Typically, readjustment is not necessary unless components or circuit board assemblies have been replaced. If readjustment is to be performed, the accuracy of the voltmeter used for voltage measurements and the combined accuracy of the voltmeter and dc shunt used for current measurements must be better than 0.1%. Refer to Figure 4-1 and Figure 4-2 for the location of the adjustment potentiometers.

### 4.2.1 Output Voltage Zero Adjustment

Use the following procedure to adjust the output voltage minimum value to 0V:

1. Connect an external voltmeter across the output terminals of the power supply.
2. Set the COARSE and FINE VOLTAGE controls to their minimum settings (fully counter-clockwise).



3. Adjust potentiometer VR204 on the Main Control Board for a reading of 0V on the external voltmeter.

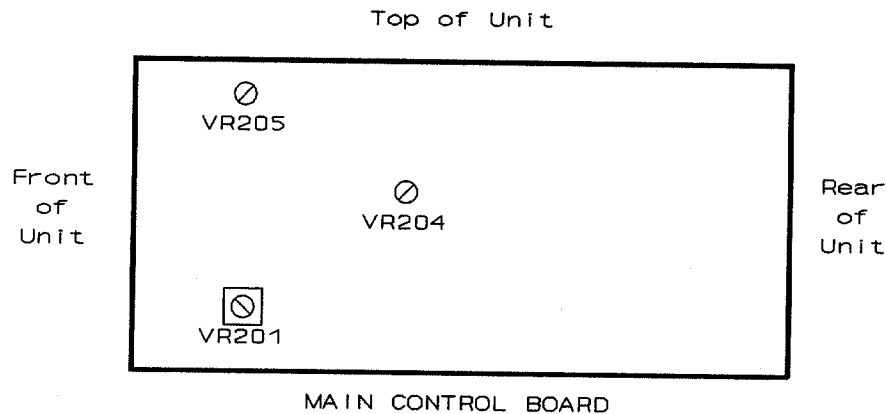

Figure 4-1. Control Board Potentiometer Locations

#### 4.2.2 Output Voltage Range Adjustment

Use the following procedure to adjust the output voltage maximum value:

1. Connect an external voltmeter across the output terminals of the power supply.
2. Set the COARSE and FINE VOLTAGE controls to their maximum settings (fully clockwise).
3. Adjust potentiometer VR201 on the Main Control Board for a reading on the external voltmeter of 1.05 times the rated output voltage of the unit.

#### 4.2.3 Voltage Display Adjustment

After performing the steps in Subsection 4.2.2, OUTPUT VOLTAGE RANGE ADJUSTMENT, use the following procedure to adjust the VOLTAGE display:

1. Reset the COARSE and FINE VOLTAGE controls so that the external voltmeter reading is equal to the rated output voltage of the unit.
2. Adjust potentiometer VR201 on the Display Board so that the unit's VOLTAGE display has a reading equal to the rated output voltage of the unit.

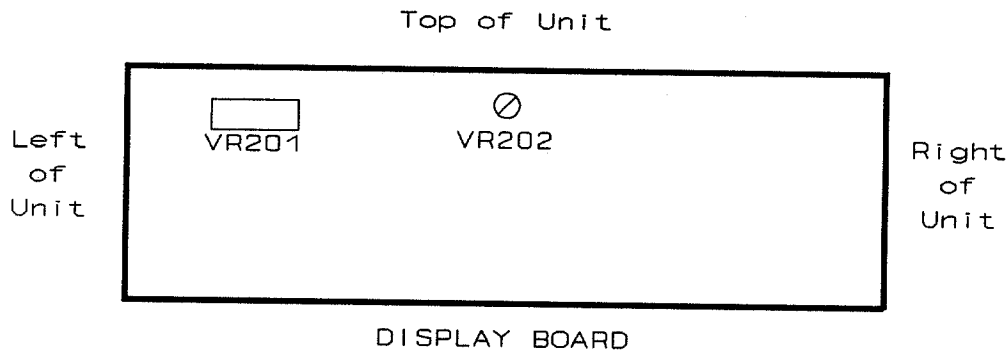

Figure 4-2. Display Board Potentiometer Locations

#### 4.2.4 Output Current Range Adjustment

Use the following procedure to adjust the output current maximum value:

1. Set the COARSE and FINE VOLTAGE controls so that the output voltage is 5V.
2. With the power supply turned off, connect an external dc shunt across the output terminals of the power supply. Ensure that the current rating of the dc shunt and wiring exceed 1.05 times the rated output current of the unit. On models LH 8-30 and LH 18-20, connect the dc shunt to the rear panel terminal block.
3. Set the COARSE and FINE CURRENT controls to their maximum settings (fully clockwise).
4. Adjust potentiometer VR205 on the Main Control Board while monitoring the reading on the external voltmeter. Calculate the output current by multiplying the voltage reading by a conversion factor equal to the rated current of the dc shunt divided by the rated burden voltage of the dc shunt. Adjust for an output current equal to 1.05 times the rated output current of the unit.

#### 4.2.5 Current Display Adjustment

After performing the steps in Subsection 4.2.4, OUTPUT CURRENT RANGE ADJUSTMENT, use the following procedure to adjust the CURRENT display:

1. Reset the COARSE and FINE CURRENT controls while monitoring the reading on the external voltmeter. Calculate the output current by multiplying the voltage reading by a conversion factor equal to the rated current of the dc shunt divided by the rated burden voltage of the dc shunt. Reset the controls for an output current equal to the rated output current of the unit.
2. Adjust potentiometer VR202 on the Display Board so that the unit's CURRENT display has a reading equal to the rated output current of the unit.

### 4.3 FACTORY SERVICE INFORMATION

Questions concerning the operation, repair, or service of a power supply should be directed to Sorensen. Include the model number and the serial number in any correspondence concerning a power supply.

To return a defective unit, contact Sorensen and obtain an RMA number for return authorization. Unauthorized returns will not be accepted and will be returned at the shipper's expense.

SORENSEN  
Repair Department  
Division of Elgar  
6255 Ferris Square  
San Diego, CA 92121-2294  
1-800-458-4258  
Tel: (858) 450-0085  
Fax: (858) 677-9453  
[www.sorensen.com](http://www.sorensen.com)

# Artisan Technology Group is an independent supplier of quality pre-owned equipment

## Gold-standard solutions

Extend the life of your critical industrial, commercial, and military systems with our superior service and support.

## We buy equipment

Planning to upgrade your current equipment? Have surplus equipment taking up shelf space? We'll give it a new home.

## Learn more!

Visit us at [artisanng.com](http://artisanng.com) for more info on price quotes, drivers, technical specifications, manuals, and documentation.

Artisan Scientific Corporation dba Artisan Technology Group is not an affiliate, representative, or authorized distributor for any manufacturer listed herein.

We're here to make your life easier. How can we help you today?

(217) 352-9330 | [sales@artisanng.com](mailto:sales@artisanng.com) | [artisanng.com](http://artisanng.com)

