



Artisan Technology Group is your source for quality new and certified-used/pre-owned equipment

- FAST SHIPPING AND DELIVERY
- TENS OF THOUSANDS OF IN-STOCK ITEMS
- EQUIPMENT DEMOS
- HUNDREDS OF MANUFACTURERS SUPPORTED
- LEASING/MONTHLY RENTALS
- ITAR CERTIFIED SECURE ASSET SOLUTIONS

SERVICE CENTER REPAIRS

Experienced engineers and technicians on staff at our full-service, in-house repair center

*InstraView*SM REMOTE INSPECTION

Remotely inspect equipment before purchasing with our interactive website at www.instraview.com ↗

WE BUY USED EQUIPMENT

Sell your excess, underutilized, and idle used equipment. We also offer credit for buy-backs and trade-ins. www.artisanng.com/WeBuyEquipment ↗

LOOKING FOR MORE INFORMATION?

Visit us on the web at www.artisanng.com ↗ for more information on price quotations, drivers, technical specifications, manuals, and documentation

Contact us: (888) 88-SOURCE | sales@artisanng.com | www.artisanng.com

ABI PRISM® 377 DNA Sequencer Parts and Accessories

PLATES

P/N

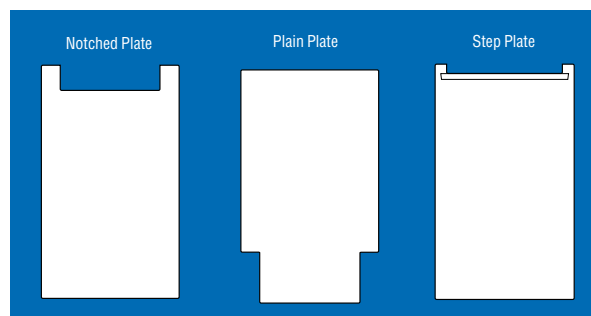

12 cm notched	401834
12 cm plain	401833
12 cm step	4306870
24 cm notched	4306871
24 cm plain	4307820
24 cm step	4306872
36 cm notched	401840
36 cm plain	401839
36 cm step	4305384
48 cm notched	401838
48 cm plain	401835
48 cm step	4305387

NOTE: All glass plates have model and part number etched in lower right corner.

GEL SPACERS (SET OF 2)

P/N

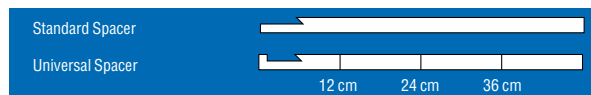

0.2 mm 12 cm long	401826
0.2 mm 36 cm long	401836
0.2 mm 48 cm long	401837
0.2 mm universal*	4304622

*Contains two 48 cm spacers marked with 12, 24, and 36 cm lines to allow users to cut to length. Has upper cut-out modified to prevent wicking.

KITS (PLATES & SPACERS)

P/N

Kits contain plates and spacers. Step plate kits contain only one set, standard kits contain 2 sets (2 notch, 2 plain, 2 sets of spacers).

12 cm standard	401877
24 cm standard	4307819
36 cm standard	401876
48 cm standard	401878
12 cm step	4307817
24 cm step	4307818
36 cm step	4305693
48 cm step	4305810

COMBS SEQUENCING

P/N

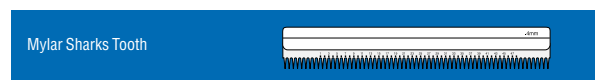

18 lane 0.2 mm Mylar sharks tooth	402168
32 lane 0.2 mm Mylar sharks tooth	401922
36 lane 0.2 mm Mylar sharks tooth	401828
48 lane 0.2 mm Mylar sharks tooth	402177
64 lane 0.2 mm Mylar sharks tooth	402180
96 lane 0.4 mm Mylar sharks tooth	4305385

Mylar® sharks tooth combs have an integral casting comb.

COMBS SINGLE-USE (BOX OF 50)

P/N

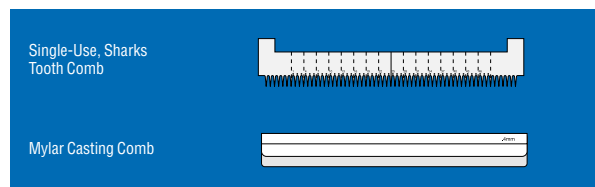

36 lane 0.2 mm single-use, sharks tooth	4309451
48 lane 0.2 mm single-use, sharks tooth	4309453
64 lane 0.2 mm single-use, sharks tooth	4309455
36 lane 0.3 mm single-use, sharks tooth	4309461
48 lane 0.3 mm single-use, sharks tooth	4309462
64 lane 0.3 mm single-use, sharks tooth	4309464
96 lane 0.4 mm single-use, sharks tooth	4309457
0.2 mm Mylar casting comb, 1 each	401913
0.4 mm Mylar casting comb, 1 each	401915

Single-use combs require the casting comb listed above.

COMBS FOR FRAGMENT ANALYSIS

P/N

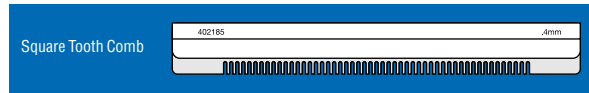

Square Tooth Comb	402185
18 well 0.2 mm Mylar square tooth	402172
24 well 0.2 mm Mylar square tooth	401904
34 well 0.2 mm Mylar square tooth	401907
36 well 0.2 mm Mylar square tooth	401910
50 well 0.2 mm Mylar square tooth	402053
66 well 0.2 mm Mylar square tooth	402183



50 Well Overlay	402187
18 well overlay*	402169
34 well overlay*	401777
50 well overlay*	402186
66 well overlay*	402187

*Used to indicate lane position on cast well gels.

SPARE PARTS

P/N

NOTE: Gel injection fixtures are not interchangeable between black and gray cassette styles.

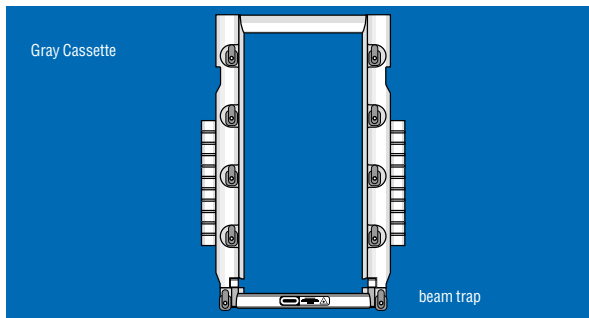

Gray cassette	4304403
Single piece cassette compatible only with the gel injection fixture for gray cassette 4307961	
Newer style, shipped with instruments from January 1999.	
Beam trap for gray cassette	4304417
Gel injection fixture kit for gray cassette	4307961
Includes clamp, injection tray, 5 gaskets, syringe and instructions	

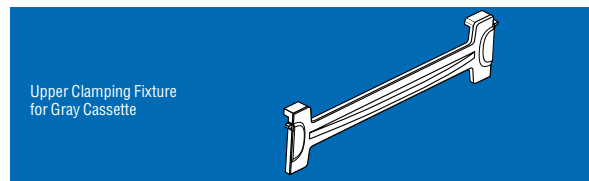

Upper clamping fixture for gray cassette	4304404
Seal for upper clamping fixture	4304410



Injection tray for gray cassette, includes 5 gaskets	4304405
Gasket for gray cassette injection fixture, 1 each	4304414

SPARE PARTS FOR OLDER STYLE BLACK CASSETTES

P/N

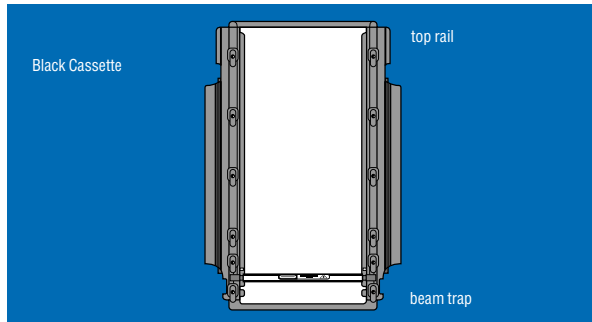

Black cassette	(Discontinued; replaced with 4304403)
Older style, shipped with instruments from January 1995–December 1998	
Compatible only with acrylic gel injection fixture for black cassette 401991	
Top rail for black cassette	6916
Beam trap for black cassette	604453
Acrylic gel injection fixture for black cassette, top and bottom	401991
Includes top and bottom fixtures, clamp, syringe and luer fitting.	

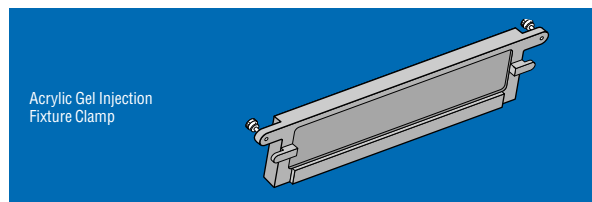

Acrylic gel injection fixture clamp	604032
Nylon thumb screws	212309

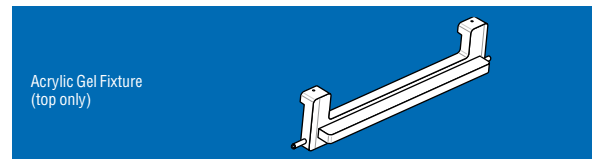

Acrylic gel injection fixture (top only)	603963
--	--------

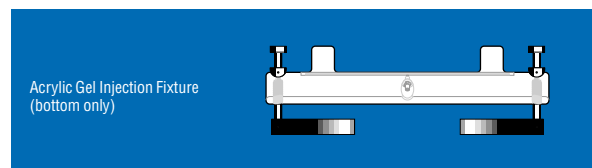

Acrylic gel injection fixture (bottom only)	604014
Gasket	5927
Luer fitting, 6 each	110292
For acrylic gel injection fixture.	

BUFFER RESERVOIRS

P/N

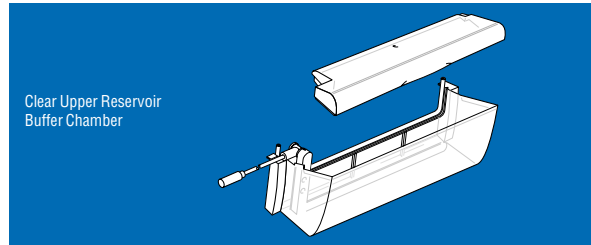

Clear upper reservoir buffer chamber with electrode 4304406
New molded part includes reservoir, gasket, electrode and cover.
Clear upper reservoir field kit 4306187
Includes reservoir, gasket and cover without electrode.



Tubular gasket kit for clear chamber 4307172
Includes two gaskets, adhesive and instructions.
Gasket adhesive for clear chamber 4308174

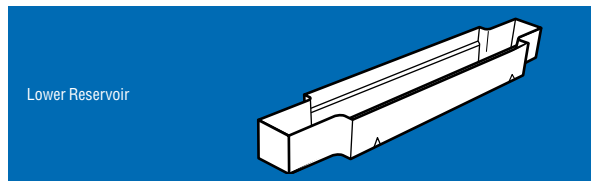

Lower reservoir, complete with electrode 603875
Lower reservoir, without electrode 4308298
Replacement electrode, lower* 603823
Replacement electrode, upper* 603822
*Used on all 377 system buffer chambers.

SPARE PARTS FOR OLDER STYLE

UPPER RESERVOIR

P/N

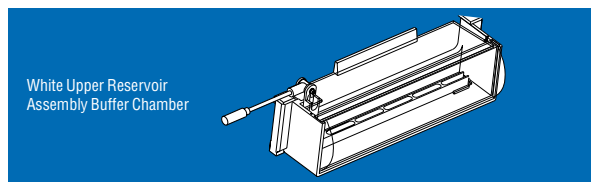

White upper reservoir assembly buffer chamber (Discontinued; replaced with 4304406)
Older design with magnifying lens includes lid, electrode and gasket.
Lid for white chamber 006501



Green gaskets for use on white chambers, 5 each with adhesive 604524
Gasket adhesive for green gasket 201480

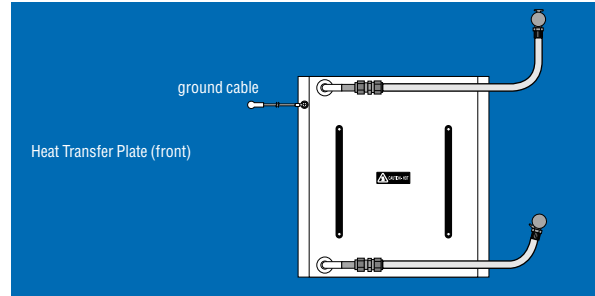

Heat transfer plate (front) 4304201
Ground cable 603639
Quick disconnect elbow fitting for cooling system 110268

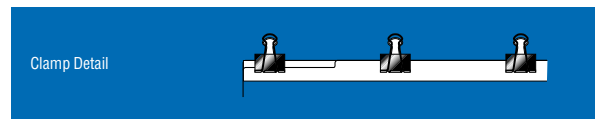

Stainless steel gel injection clamp, 1 each 4305386

COMPUTER

P/N

Complete Power Macintosh® G4 computer with extra copy of analysis, either Sequencing Analysis or GeneScan® software. 4305701

SUPPORTING LITERATURE

P/N

Easily download software, user bulletins, manuals, and application notes from our website at <http://www.appliedbiosystems.com/ab/techsupp>.

Linkage Mapping Set-MD10 (LMS v2) Product Bulletin (MD-medium density, 10-centimorgan)	237633-001
ABI PRISM® Linkage Mapping Set-LD20 Product Bulletin (LD-low density, 20-centimorgan)	107PB01-01
ABI PRISM® Linkage Mapping Set Panel Guide	4308138
ABI PRISM® Linkage Mapping Set (MD10 & LD20) Chromosome Maps	107MI01-01
The Development and Uses of the NED™ Dye	237834-001
How to Adapt the 377 System to Perform Subambient Cooling	237837-001
Genotyping Software Suite Brochure	237110-002
GeneScan™ Size Standards Product Bulletin	237636-002
GeneScan Kit Reference Guide	4303188
PCR SSCP Analysis Technical Booklet	237825-002
Glass Plate Cleaning	237843-001
Using the New Cassette and Gel Injection Fixtures	106UB02-01
Using the dRhodamine Matrix Standards Kit User Bulletin	904917
Sequencing Large DNA Templates User Bulletin	237844-001
Precipitation Methods to Removing Residual Dye Terminators from Sequencing Reactions	237842-001
Mitochondrial DNA Sequencing Technical Booklet	237820-001
Improved Gel Formulations for Extended Read Lengths	237839-001
Sequencing Chemistry Guide	4305080
Optimizing 96 Lanes User Bulletin	106UB03-01

SUPPORTING LITERATURE

P/N

BAC End Sequencing Using BigDye™ Primers and BigDye™ Terminators Application Note	230401-001
Heterozygote Detection Using BigDye™ Terminators Application Note	230403-001
BigDye™ Chemistries Application Note	230402-001
Dilution of BigDye™ Terminators Application Note	107AP01-01

MANUALS

P/N

377 DNA Sequencer User's Manual	4303613
XL Upgrade User's Manual	904412
96-lane Upgrade User's Manual	4305423
377-18 User's Manual	904092
Site Prep and Safety Guide	903393
Quick Reference Card	4307398
GenBase™ Software v 2.0.1 User's Manual	403000
GeneScan® Software v 3.1 User's Manual	403001
Genotyper® Software v 2.5 User's Manual	401737
Sequencing Analysis Software v 3.4 and Fatura™ Software v 2.2 Manuals	4307851

ANALYSIS SOFTWARE

P/N

Sequencing Analysis v 3.4	677-70
GeneScan v 3.1 For 377-01, -XL, -96 For 377-18	672-70 672-18

SOFTWARE UPDATES

P/N

Download software updates free from www.appliedbiosystems.com/ab/techsupp/swpps/377sw.html.
CD-ROM format is available for licensed users who cannot download from the website.

GeneScan v 3.1 Update Kit for versions 2.1 thru 3.0	4307771
Genotyper v 2.5 Update Kit for versions 2.1 thru 2.4	4309139
Sequencing Analysis v 3.4 for versions 3.0 to 3.3 (1 unit per packages)	4307740
2.6 Collection*	4313653

*Collection software also available on floppy disk.

SOFTWARE UPGRADES

P/N

From listed revision to current revision.

Sequencing Analysis v 3.4 upgrade for all previous versions	401760
GeneScan v 3.1 upgrade to all previous versions	4309951

INTERNET SITES

www.appliedbiosystems.com

BioBeat:

www.biobeat.com

Online magazine, featuring discoveries made by life science researchers.

Easily download software, user bulletins, manuals, and new products from our website at www.appliedbiosystems.com/ab/techsupp/.

Worldwide Sales Offices

Worldwide Sales Offices
Applied Biosystems vast distribution and service network, composed of highly trained support and applications personnel, reaches into 150 countries on six continents. For international office locations, please call the division headquarters or refer to our web site at www.appliedbiosystems.com.

Headquarters

850 Lincoln Centre Drive
Foster City, CA 94404 USA
Phone: 650.638.5800
Toll Free: 800.345.5224
Fax: 650.638.5884



850 Lincoln Centre Drive
Foster City, CA 94404 USA

PE Corporation is committed to providing the world's leading technology and information for life scientists. PE Corporation consists of the Applied Biosystems and Celera Genomics businesses.

For Research Use Only.
Not for use in diagnostic procedures.



BigDye and GenBase are trademark and ABI Prism and its design, GeneScan, GenoPedigree, Genotyper, and Applied Biosystems are registered trademarks of

PE Corporation or its subsidiaries in the US and certain other countries.
Power Macintosh is a registered trademark of Apple Computer, Inc.
Applied Biosystems develops and manufactures its products in accordance with ISO 9000 quality system requirements.

©2000 Applied Biosystems. All rights reserved.
Information subject to change without notice.

Printed in the U.S.A. 8/2000, JPI
Publication 106M09-02



Artisan Technology Group is your source for quality new and certified-used/pre-owned equipment

- FAST SHIPPING AND DELIVERY
- TENS OF THOUSANDS OF IN-STOCK ITEMS
- EQUIPMENT DEMOS
- HUNDREDS OF MANUFACTURERS SUPPORTED
- LEASING/MONTHLY RENTALS
- ITAR CERTIFIED SECURE ASSET SOLUTIONS

SERVICE CENTER REPAIRS

Experienced engineers and technicians on staff at our full-service, in-house repair center

*InstraView*SM REMOTE INSPECTION

Remotely inspect equipment before purchasing with our interactive website at www.instraview.com ↗

WE BUY USED EQUIPMENT

Sell your excess, underutilized, and idle used equipment. We also offer credit for buy-backs and trade-ins. www.artisanng.com/WeBuyEquipment ↗

LOOKING FOR MORE INFORMATION?

Visit us on the web at www.artisanng.com ↗ for more information on price quotations, drivers, technical specifications, manuals, and documentation

Contact us: (888) 88-SOURCE | sales@artisanng.com | www.artisanng.com