



## Artisan Technology Group is your source for quality new and certified-used/pre-owned equipment

- FAST SHIPPING AND DELIVERY
- TENS OF THOUSANDS OF IN-STOCK ITEMS
- EQUIPMENT DEMOS
- HUNDREDS OF MANUFACTURERS SUPPORTED
- LEASING/MONTHLY RENTALS
- ITAR CERTIFIED SECURE ASSET SOLUTIONS

### SERVICE CENTER REPAIRS

Experienced engineers and technicians on staff at our full-service, in-house repair center

### *InstraView*<sup>SM</sup> REMOTE INSPECTION

Remotely inspect equipment before purchasing with our interactive website at [www.instraview.com](http://www.instraview.com) ↗

### WE BUY USED EQUIPMENT

Sell your excess, underutilized, and idle used equipment. We also offer credit for buy-backs and trade-ins. [www.artisanng.com/WeBuyEquipment](http://www.artisanng.com/WeBuyEquipment) ↗

### LOOKING FOR MORE INFORMATION?

Visit us on the web at [www.artisanng.com](http://www.artisanng.com) ↗ for more information on price quotations, drivers, technical specifications, manuals, and documentation

**Contact us:** (888) 88-SOURCE | [sales@artisanng.com](mailto:sales@artisanng.com) | [www.artisanng.com](http://www.artisanng.com)

# IntelliPack® 800 Series



## Intelligent Alarms

### 811A Alarm, 812A Dual Alarm

#### DC Current, DC Voltage, and AC Current Input

##### Models

811A-0100: Alarm with one DPDT relay

811A-0200: Alarm with two SPDT relays

812A-0200: Dual alarm with two SPDT relays

##### Input Ranges

DC Current: 0 to 22mA

DC Voltage:  $\pm 100V$  DC

AC Current: 0 to 20A AC (with AC current sensor)

##### Alarm Outputs

Single DPDT electro-mechanical 5A relay (-0100),

Dual SPDT electro-mechanical 5A relays (-0200)

##### Power Requirement

10 to 36V DC

##### Approvals

CE marked. UL, cUL listed.

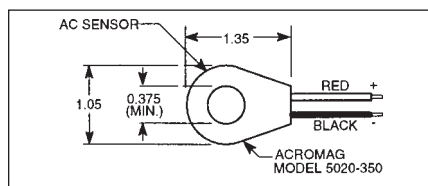

AC Current Sensor Model 5020-350  
(ordered separately)

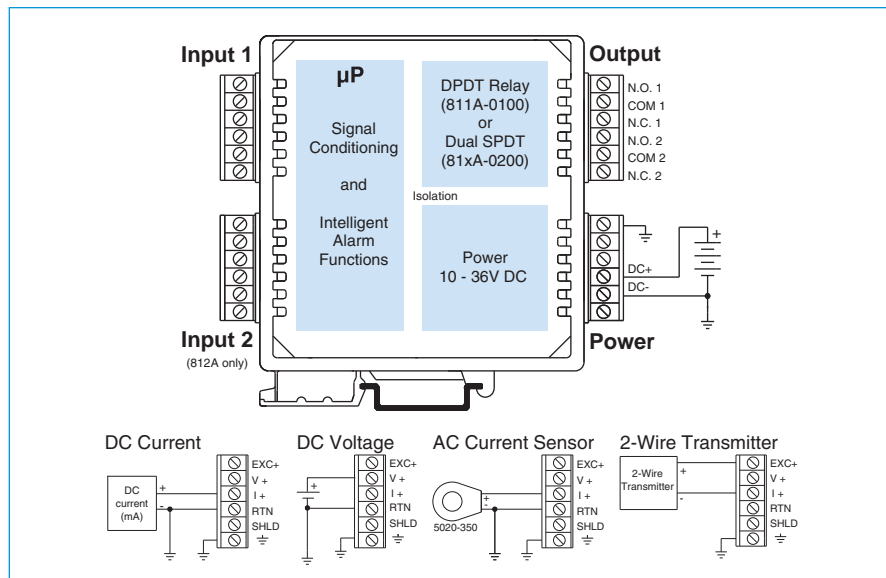

#### Description

IntelliPack alarms compare inputs against user-defined limit setpoints to control built-in relays.

Each unit offers a selection of input ranges and alarm functions to handle a broad range of applications. As your needs change, you can easily reconfigure the unit for different ranges or functions. Alarm functions available on all models include on/off controller, limit alarm, window alarm, deviation alarm, rate-of-change alarm, and peak/valley detection.

Setup is very easy. IntelliPack alarms are configured through a user-friendly Windows XP/Vista/7 program. Field adjustments and recalibration are quickly performed with front-panel push-buttons and status LEDs. Once configured, IntelliPacks operate independent of any host computer.

#### Special Features

- Integrated microcontroller performs intelligent signal processing for advanced alarm functions.
- Windows XP/Vista/7 software configuration speeds setup and replacement.
- Push-button reprogrammability facilitates changes in the field without a host PC.
- Multi-purpose inputs accept numerous ranges to reduce spare stock requirements.
- High-resolution Sigma-Delta A/D converter delivers high accuracy with low noise.

- Input excitation supply on each input provides power for a two-wire transmitter.
- Dual alarm operation lets you perform two alarm functions at the same time.

#### Performance

##### General Input

Analog to Digital (A/D) Converter  
16-bit  $\Sigma$ - $\Delta$  A/D converter.

##### Ambient Temperature Effect

Better than  $\pm 0.005\%$  of input span per  $^{\circ}C$  or  $\pm 1\mu V$ , whichever is greater.

##### Noise Rejection

Normal Mode: Better than 40dB @ 60Hz.

Common Mode: Better than 100dB @ 60Hz.

##### Input Filter

Normal mode filtering, plus digital filtering optimized and fixed per input range within  $\Sigma$ - $\Delta$  ADC.

##### Input Response Time

Less than 100mS to 98% of final value for a step change in the input. A software programmable delay can be implemented for filtering transients.

##### Relay Time Delay

Adjustable alarm delay of up to 25 seconds.

##### Input Overvoltage Protection

Bipolar Transient Voltage Suppressors (TVS).

##### Accuracy (DC Voltage/Current Inputs)

Better than  $\pm 0.05\%$  of input span.

*Continued on next page.*



Tel: 248-295-0880 Fax: 248-624-9234 e-mail: sales@acromag.com www.acromag.com

# Signal Conditioners



## ■ DC Current Input

### DC Current Input Range

Input Ranges	Resolution
0 to 5mA DC	189nA/LSB
0 to 22mA DC	757nA/LSB

### DC Current Input Impedance

24.9 ohms.

### Excitation Supply (for 2-wire instruments)

+15V DC, 24mA maximum.

## ■ DC voltage Input

### DC Voltage Input Ranges

Input Ranges	Resolution
±100V DC	3.77mV
±50V DC	1.88mV
±25V DC	942µV
±12V DC	471µV
±6V DC	236µV
±3V DC	118µV

### Input impedance

Greater than 500K ohms.

## ■ AC Current Input

### AC Current Input Range (optional)

An optional external AC current sensor is required to monitor AC current signals (Model 5020-350).

AC Current Range	Primary Turns
0 to 20A AC	1
0 to 10A AC	2
0 to 5A AC	4
0 to 2A AC	10
0 to 1A AC	20

## ■ Output

### Relay (811A-0100 model)

One DPDT electro-mechanical relay.  
Contact material Silver Nickel (AgNi 90/10).

### Relays (811A-0200, 812A-0200 models)

Two independent SPDT electro-mechanical relays.  
Contact material Silver-Cadmium Oxide (AgCdO).

### Relay Ratings (CSA ratings)

25V DC @ 5A.  
120/240V AC @ 5A.

### Expected Mechanical Life

20 million operations.

## ■ Environmental

### Ambient Temperature

Operating: -25 to 70°C (-13 to 158°F).  
Storage: -40 to 85°C (-40 to 185°F).

### Relative Humidity

5 to 95%.

### Power Requirements

811A:

10 to 36V DC. 70mA @ 24V. 110mA @ 15V.

812A:

10 to 36V DC. 110mA @ 24V. 155mA @ 15V.

### Isolation

3-way (input/output/power).

1500V AC for 60 seconds or 250V AC continuous.

Inputs share a common on 812A Model.

### Radiated Field Immunity (RFI)

EN61000-4-3, EN50082-1.

### Electromagnetic Field Immunity (EMI)

No relay trips will occur beyond ±0.25% of input span from setpoint under the influence of electromagnetic fields from switching solenoids, commutator motors, and drill motors.

### Electrical Fast Transient (EFT)

EN61000-4-4, EN50082-1.

### Surge Withstanding Capability (SWC)

EN61000-4-5, EN50082-1.

### Electrostatic Discharge (ESD)

EN61000-4-2, EN50082-1.

### Radiated Emissions

EN50081-1 for Class B equipment.

### Approvals

CE marked, UL, cUL listed (USA, Canada).

UL3121 - general product safety.

## ■ Configuration

### Software Configuration

Units are fully programmable via the Windows XP/Vista/7 IntelliPack Configuration Program. Configuration downloads from PC through EIA232 serial port using Acromag 800C-SIP kit.

### Field Configuration

Setpoint and deadband are configurable via push-buttons and a standard calibrator.

### LED Indicators

LEDs indicate power, status, and alarm.

## ■ Physical

### Enclosure

Case: Self-extinguishing NYLON type 6.6 polyamide thermoplastic UL94 V-2, color beige; general purpose NEMA Type 1 enclosure.

### Connectors (Removable terminal blocks)

Wire Range: AWG #14-22 (AWG #12 stranded only).

### Printed Circuit Boards

Military grade FR-4 epoxy glass circuit board.

### Dimensions

1.05W x 4.68H x 4.35D inches.  
26.7W x 118.9H x 110.5D millimeters.

### Shipping Weight

1 pound (0.45 Kg) packed.

## ■ Ordering Information

IMPORTANT: All IntelliPacks require initial software configuration (order 800C-SIP). See Note 1 below.

### 811A-0100

IntelliPack alarm unit.

One DC voltage/current input, one DPDT relay.

### 811A-0200

Same as above except two SPDT relays.

### 812A-0200

IntelliPack alarm unit.

Two DC voltage/current inputs, two SPDT relays.

### 5020-350

AC current sensor. Required for AC current inputs. See page 205 for more information.

### 800C-SIP

Software Interface Package.

Only one kit is required for all IntelliPack models.

See diagram on Page 83 for included parts.

### 5034-225

USB-to-RS232 adapter. See page 121 for more info.

### PS5R-D24

Power supply (24V DC, 2.1A).

See Power Supplies on Page 199.

### TBK-B02

Optional terminal block kit, barrier strip style, 4 pcs.

### TBK-S02

Optional terminal block kit, spring clamp style, 4 pcs.

NOTE 1: To order factory configuration, call Acromag for a configuration form which must accompany your order. Also, append "-C" to model number (example: 811A-0200-C). 800C-SIP kit is still recommended.



Optional terminal blocks: barrier strip (left) and spring clamp (right). Cage clamp terminal is standard.

# IntelliPack® 800 Series



## Dimensions

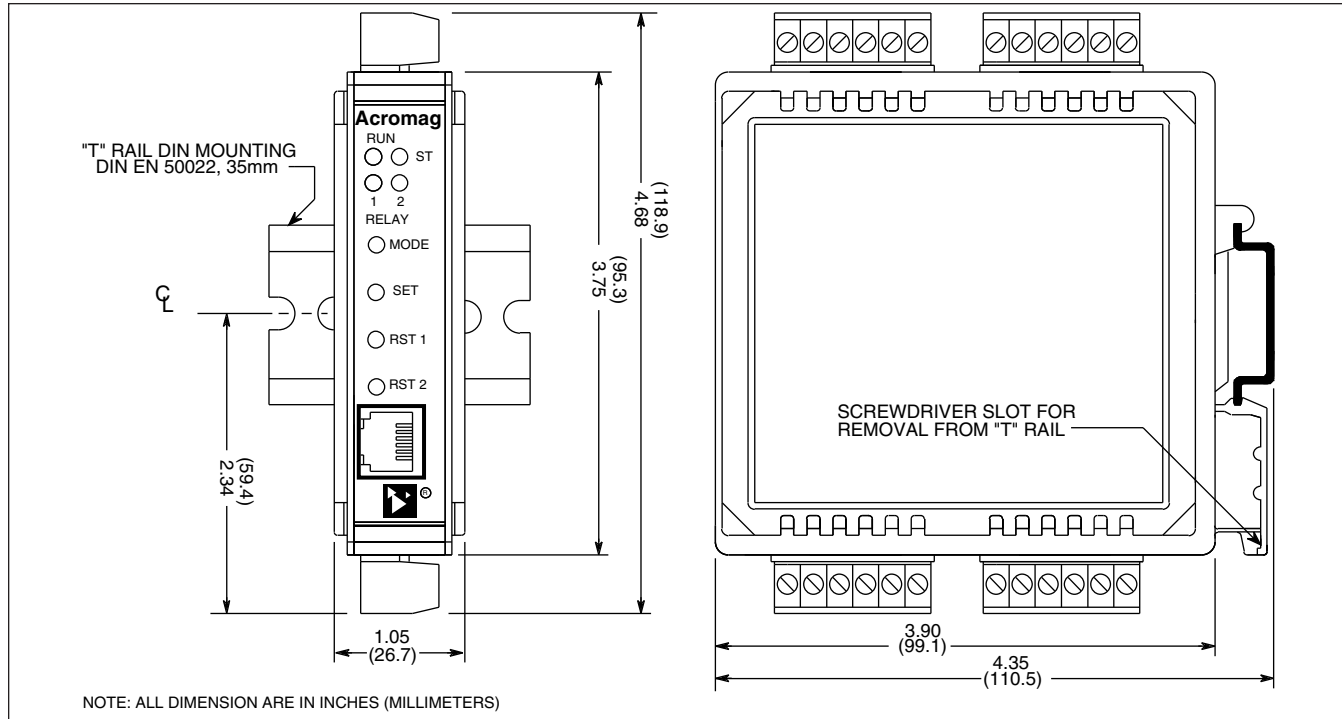

# Signal Conditioners



## Accessories

### Terminal Blocks



Barrier strip (left) and spring clamp (right).

#### Ordering Information

See individual I/O modules for compatibility.

### Barrier Strip Terminal Blocks

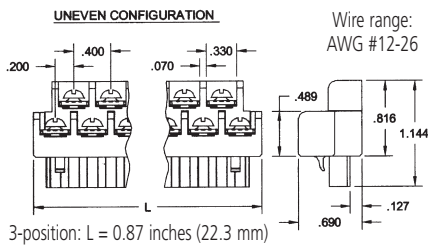
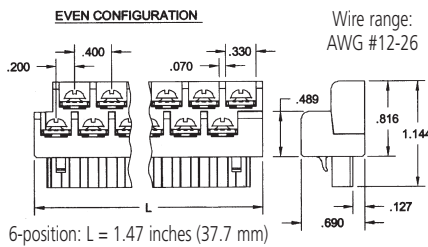

**TBK-B01**  
Terminal block kit,  
two 6-position pieces

**TBK-B02**  
Terminal block kit,  
four 6-position pieces

**TBK-B03**  
Terminal block kit,  
one 3-position and  
three 6-position pieces

### Spring Clamp Terminal Blocks

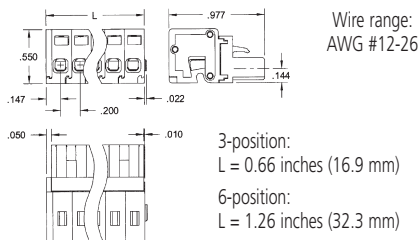

**TBK-S01**  
Terminal block kit,  
two 6-position pieces

**TBK-S02**  
Terminal block kit,  
four 6-position pieces

**TBK-S03**  
Terminal block kit,  
one 3-position and  
three 6-position pieces

### Mounting Hardware

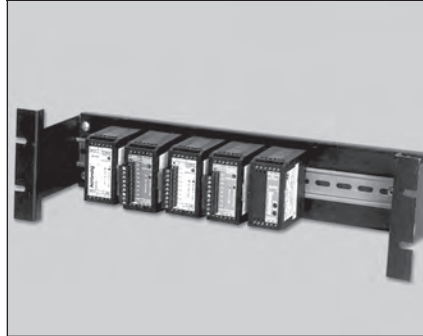

### DIN-Rail Mounting

For your convenience, Acromag offers several mounting accessories to simplify your system installation. Our 19" rack-mount kit provides a clean solution for mounting your I/O modules and a power supply. Or you can buy precut DIN rail strips for mounting on any flat surface.

#### Ordering Information

**20RM-16-DIN**  
19" rack-mount kit with DIN rail.

**DIN RAIL 3.0**  
**DIN RAIL 16.7**  
DIN rail strip, Type T, 3 inches (75mm) or  
16.7 inches (425mm)

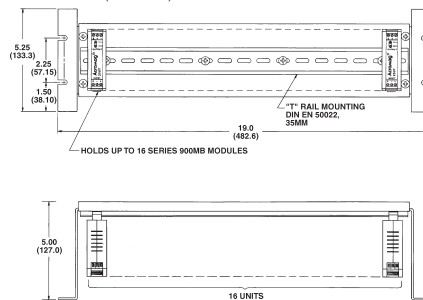

### Power Supplies

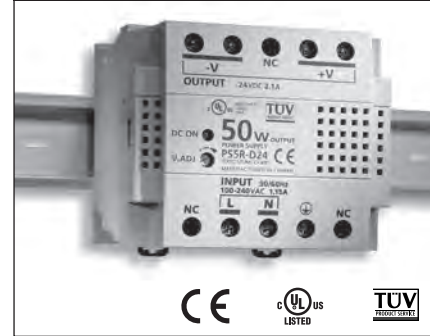

### 50W Supply

**Input Power Requirement**  
85 to 264V AC or 105 to 370V DC

**Output**  
24V DC, 2.1A (50W)

#### Ordering Information

**PS5R-D24**  
Universal 50W power supply

See Power Supplies on Page 199 for other models and more information.

### USB / RS232 Adapter



Length: 3.15 in (8.0 cm)  
Height: 0.80 in (2.03 cm)  
Width: 1.75 in (4.44 cm)  
Weight: 1.6 oz (45.36 g)

#### Ordering Information

**5034-225**  
USB-to-RS232 adapter

### AC Current Sensor

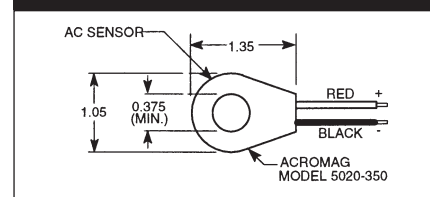

#### Ordering Information

**5020-350**  
AC current sensor (See page 205)



## Artisan Technology Group is your source for quality new and certified-used/pre-owned equipment

- FAST SHIPPING AND DELIVERY
- TENS OF THOUSANDS OF IN-STOCK ITEMS
- EQUIPMENT DEMOS
- HUNDREDS OF MANUFACTURERS SUPPORTED
- LEASING/MONTHLY RENTALS
- ITAR CERTIFIED SECURE ASSET SOLUTIONS

### SERVICE CENTER REPAIRS

Experienced engineers and technicians on staff at our full-service, in-house repair center

### *InstraView*<sup>SM</sup> REMOTE INSPECTION

Remotely inspect equipment before purchasing with our interactive website at [www.instraview.com](http://www.instraview.com) ↗

### WE BUY USED EQUIPMENT

Sell your excess, underutilized, and idle used equipment. We also offer credit for buy-backs and trade-ins. [www.artisanng.com/WeBuyEquipment](http://www.artisanng.com/WeBuyEquipment) ↗

### LOOKING FOR MORE INFORMATION?

Visit us on the web at [www.artisanng.com](http://www.artisanng.com) ↗ for more information on price quotations, drivers, technical specifications, manuals, and documentation

**Contact us:** (888) 88-SOURCE | [sales@artisanng.com](mailto:sales@artisanng.com) | [www.artisanng.com](http://www.artisanng.com)