



Artisan Technology Group is your source for quality new and certified-used/pre-owned equipment

- FAST SHIPPING AND DELIVERY
- TENS OF THOUSANDS OF IN-STOCK ITEMS
- EQUIPMENT DEMOS
- HUNDREDS OF MANUFACTURERS SUPPORTED
- LEASING/MONTHLY RENTALS
- ITAR CERTIFIED SECURE ASSET SOLUTIONS

SERVICE CENTER REPAIRS

Experienced engineers and technicians on staff at our full-service, in-house repair center

*InstraView*SM REMOTE INSPECTION

Remotely inspect equipment before purchasing with our interactive website at www.instraview.com ↗

WE BUY USED EQUIPMENT

Sell your excess, underutilized, and idle used equipment. We also offer credit for buy-backs and trade-ins. www.artisanng.com/WeBuyEquipment ↗

LOOKING FOR MORE INFORMATION?

Visit us on the web at www.artisanng.com ↗ for more information on price quotations, drivers, technical specifications, manuals, and documentation

Contact us: (888) 88-SOURCE | sales@artisanng.com | www.artisanng.com



Intelligent Alarms



822A Dual Alarm

Thermocouple and Millivolt Input

Models

822A-0200:
Dual input alarm with two SPDT relays

Input Ranges

TC types: J, K, T, R, S, E, B, N
Millivolt: $\pm 15.625\text{mV}$ to $\pm 1.0\text{V DC}$

Alarm Outputs

Dual SPDT electro-mechanical 5A relays

Power Requirement

10 to 36V DC

Approvals

CE marked. UL, cUL listed.

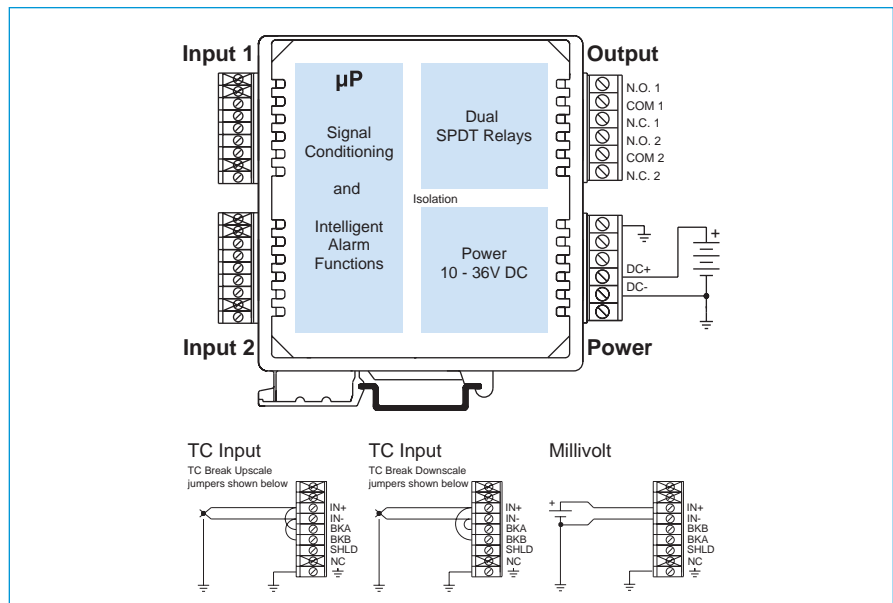

Description

IntelliPack alarms compare inputs against user-defined limit setpoints to control built-in relays.

Each unit offers a selection of input ranges and alarm functions to handle a broad range of applications. As your needs change, you can easily reconfigure the unit for different ranges or functions. Alarm functions available on all models include on/off controller, limit alarm, window alarm, deviation alarm, rate-of-change alarm, and peak/valley detection.

Setup is very easy. IntelliPack alarms are configured through a user-friendly Windows 95/98/ME/NT/XP/2000 program. Field adjustments and recalibration are quickly performed with front-panel push-buttons and status LEDs. Once configured, IntelliPacks operate independent of any host computer.

Special Features

- Integrated microcontroller performs intelligent signal processing for advanced alarm functions.
- Windows 95/98/ME/NT/XP/2000 software configuration speeds setup and replacement.
- Push-button reprogrammability facilitates changes in the field without a host PC.
- Multi-purpose inputs accept numerous ranges to reduce spare stock requirements.
- High-resolution Sigma-Delta A/D converter delivers high accuracy with low noise.
- Input excitation supply on each input provides power for a two-wire transmitter.
- Dual alarm operation lets you perform two alarm functions at the same time.



■ Performance

■ General Input

Analog to Digital (A/D) Converter
16-bit Σ - Δ A/D converter.

Resolution
 $\pm 0.005\%$ of span or $0.1^\circ\text{C}/\text{LSB}$. ADC typically yields resolutions finer than $0.1^\circ\text{C}/\text{LSB}$.

Ambient Temperature Effect
Better than $\pm 0.005\%$ of input span per $^\circ\text{C}$ or $\pm 1\mu\text{V}$, whichever is greater.

Noise Rejection
Normal Mode: Better than 40dB @ 60Hz.
Common Mode: Better than 130dB @ 60Hz.

Input Filter
Normal mode filtering, plus digital filtering optimized and fixed per input range within Σ - Δ ADC.

Input Response Time
Less than 500mS to 98% of final value for a step change in the input. A software programmable delay can be implemented for filtering transients.

Relay Time Delay
Adjustable alarm delay of up to 25 seconds.

Input Overvoltage Protection
Bipolar Transient Voltage Suppressors (TVS).

■ Thermocouple Input

Thermocouple Input Ranges
Thermocouple type user configured. Signal linearization, cold-junction compensation, and open circuit or lead break detection are included.

TC	$^\circ\text{C}$ Range ($^\circ\text{F}$ Range)	Accuracy
J	-210 to 760 $^\circ\text{C}$ (-346 to 1400 $^\circ\text{F}$)	$\pm 0.5^\circ\text{C}$
K	-200 to 1372 $^\circ\text{C}$ (-328 to 2502 $^\circ\text{F}$)	$\pm 0.5^\circ\text{C}$
T	-260 to 400 $^\circ\text{C}$ (-436 to 752 $^\circ\text{F}$)	$\pm 0.5^\circ\text{C}$
R	-50 to 1768 $^\circ\text{C}$ (-58 to 3214 $^\circ\text{F}$)	$\pm 1.0^\circ\text{C}$
S	-50 to 1768 $^\circ\text{C}$ (-58 to 3214 $^\circ\text{F}$)	$\pm 1.0^\circ\text{C}$
E	-200 to 1000 $^\circ\text{C}$ (-328 to 1832 $^\circ\text{F}$)	$\pm 0.5^\circ\text{C}$
B	260 to 1820 $^\circ\text{C}$ (500 to 3308 $^\circ\text{F}$)	$\pm 1.0^\circ\text{C}$
N	-230 to 1300 $^\circ\text{C}$ (-382 to 2372 $^\circ\text{F}$)	$\pm 0.5^\circ\text{C}$

Thermocouple Break Detection
Upscale or downscale.

■ DC Millivolt Input

DC Millivolt/Voltage Input Ranges

$\pm 1.0\text{V}$	$\pm 125\text{mV}$	$\pm 31.25\text{mV}$
$\pm 500\text{mV}$	$\pm 62.5\text{mV}$	$\pm 15.625\text{mV}$
$\pm 250\text{mV}$		

Millivolt Accuracy
Better than $\pm 0.05\%$ of input span.

■ Output

Relays
Two independent SPDT electro-mechanical relays.
Contact material Silver-Cadmium Oxide (AgCdO).

Relay Ratings (CSA ratings)
25V DC @ 5A.
120/240V AC @ 5A.

Expected Mechanical Life
20 million operations.

■ Environmental

Ambient Temperature
Operating: -25 to 70°C (-13 to 158°F).
Storage: -40 to 85°C (-40 to 185°F).

Relative Humidity
5 to 95%.

Power Requirements
10 to 36V DC. 60mA @ 24V. 90mA @ 15V.

Isolation
3-way (input/output/power).
1500V AC for 60 seconds or 250V AC continuous.
Inputs are isolated (up to 48V) from each other.

Radiated Field Immunity (RFI)
EN61000-4-3, EN50082-1.

Electromagnetic Field Immunity (EMI)
No relay trips will occur beyond $\pm 0.25\%$ of input span from setpoint under the influence of electromagnetic fields from switching solenoids, commutator motors, and drill motors.

Electrical Fast Transient (EFT)
EN61000-4-4, EN50082-1.

Surge Withstanding Capability (SWC)
EN61000-4-5, EN50082-1.

Electrostatic Discharge (ESD)
EN61000-4-2, EN50082-1.

Radiated Emissions
EN50081-1 for Class B equipment.

Approvals
CE marked, UL, cUL listed (USA, Canada).
UL3121 - general product safety.

■ Configuration

Software Configuration
Units are fully programmable via the Windows 95/98/ME/2000/NT/XP IntelliPack Configuration Program. Configuration downloads from PC through EIA232 serial port using Acromag 800C-SIP kit.

Field Configuration
Setpoint and deadband are configurable via push-buttons and a standard calibrator.

LED Indicators
LEDs indicate power, status, and alarm.

■ Physical

Enclosure
Case: Self-extinguishing NYLON type 6.6 polyamide thermoplastic UL94 V-2, color beige; general purpose NEMA Type 1 enclosure.

Connectors (Removable terminal blocks)
Wire Range: AWG #14-22 (AWG #12 stranded only).

Printed Circuit Boards
Military grade FR-4 epoxy glass circuit board.

Dimensions
1.05W x 4.68H x 4.35D inches.
26.7W x 118.9H x 110.5D millimeters.

Shipping Weight
1 pound (0.45 Kg) packed.

■ Ordering Information

IMPORTANT: All IntelliPacks require initial software configuration (order 800C-SIP). See Note 1 below.

822A-0200
IntelliPack alarm unit.
Two thermocouple/millivolt inputs, two SPDT relays.

800C-SIP
Software Interface Package.
Only one kit is required for all IntelliPack models.
See diagram on Page 73 for included parts.

5034-225
USB-to-RS232 adapter. See page 117 for more info.

PS5R-D24
Power supply (24V DC, 2.1A).
See Power Supplies on page 213.

TBK-B01
Optional terminal block kit, barrier strip style, 2 pcs.
(Does not include terminal block for input wiring.)

TBK-S01
Optional terminal block kit, spring clamp style, 2 pcs.
(Does not include terminal block for input wiring.)

NOTE 1: To order factory configuration, call Acromag for a configuration form which must accompany your order. Also, append "-C" to model number (example: 822A-0200-C). 800C-SIP kit is still recommended.



Optional terminal blocks: barrier strip (left) and spring clamp (right). Cage clamp terminal is standard.



Accessories

Terminal Blocks



Barrier strip (left) and spring clamp (right).

Ordering Information

See individual I/O modules for compatibility.

Barrier Strip Terminal Blocks

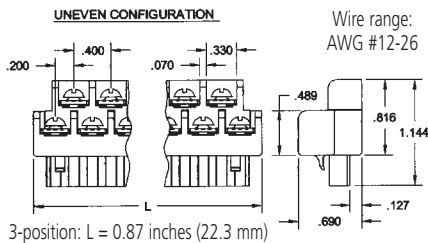
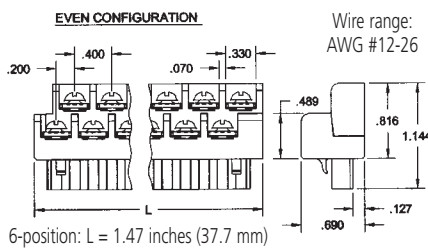

TBK-B01
Terminal block kit,
two 6-position pieces

TBK-B02
Terminal block kit,
four 6-position pieces

TBK-B03
Terminal block kit,
one 3-position and
three 6-position pieces

Spring Clamp Terminal Blocks

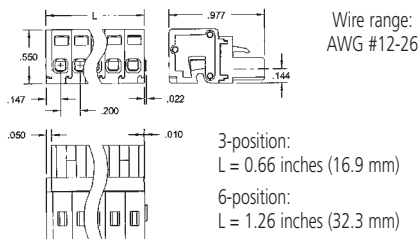

TBK-S01
Terminal block kit,
two 6-position pieces

TBK-S02
Terminal block kit,
four 6-position pieces

TBK-S03
Terminal block kit,
one 3-position and
three 6-position pieces

Mounting Hardware



DIN-Rail Mounting

For your convenience, Acromag offers several mounting accessories to simplify your system installation. Our 19" rack-mount kit provides a clean solution for mounting your I/O modules and a power supply. Or you can buy precut DIN rail strips for mounting on any flat surface.

Ordering Information

20RM-16-DIN
19" rack-mount kit with DIN rail.

DIN RAIL 3.0
DIN RAIL 16.7
DIN rail strip, Type T, 3 inches (75mm) or
16.7 inches (425mm)

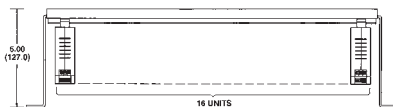
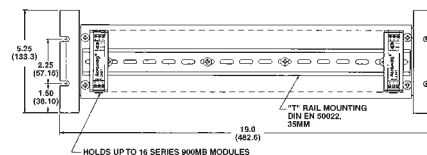

Power Supplies



50W Supply

Input Power Requirement
85 to 264V AC or 105 to 370V DC

Output
24V DC, 2.1A (50W)

Ordering Information

PS5R-D24
Universal 50W power supply

See Power Supplies on page 213 for other models and more information.

USB / RS232 Adapter



Length: 3.15 in (8.0 cm)
Height: 0.80 in (2.03 cm)
Width: 1.75 in (4.44 cm)
Weight: 1.6 oz (45.36 g)

Ordering Information

5034-225
USB-to-RS232 adapter

AC Current Sensor

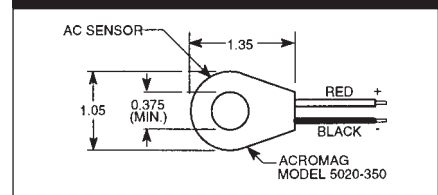

Ordering Information

5020-350
AC current sensor



Dimensions

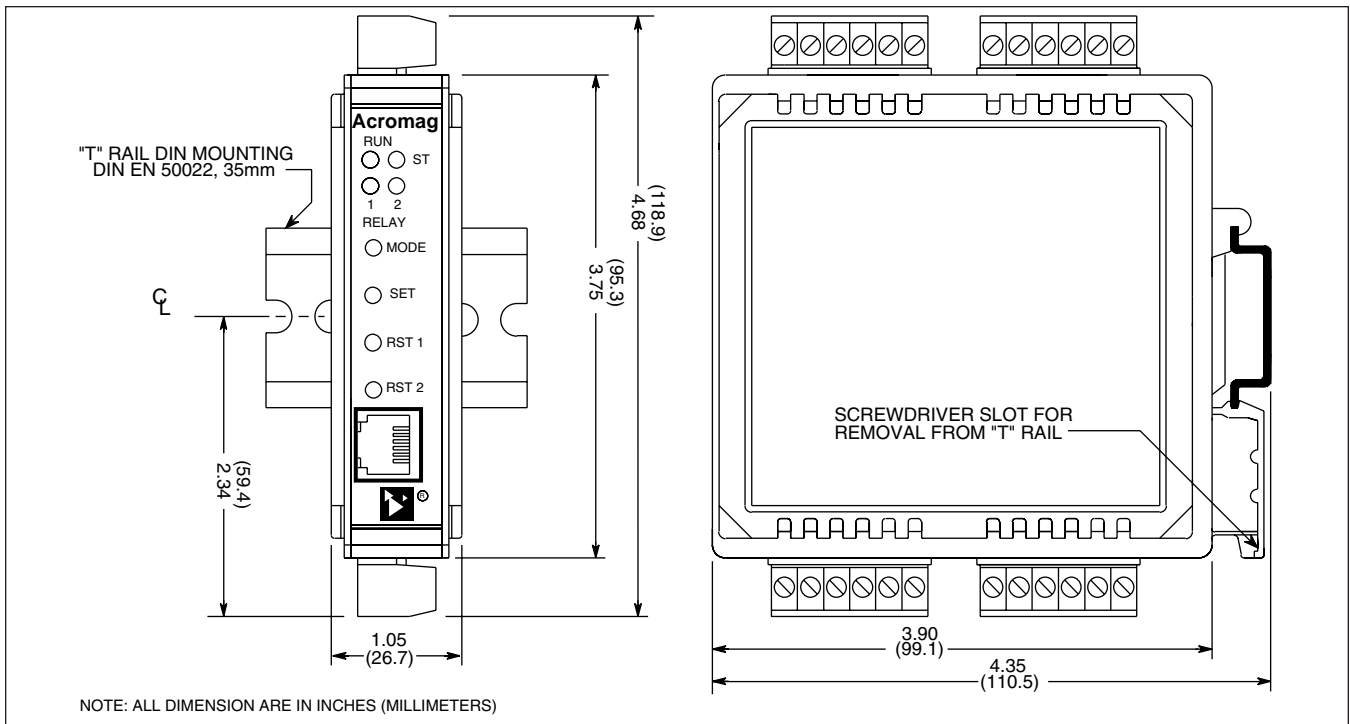



Artisan Technology Group is your source for quality new and certified-used/pre-owned equipment

- FAST SHIPPING AND DELIVERY
- TENS OF THOUSANDS OF IN-STOCK ITEMS
- EQUIPMENT DEMOS
- HUNDREDS OF MANUFACTURERS SUPPORTED
- LEASING/MONTHLY RENTALS
- ITAR CERTIFIED SECURE ASSET SOLUTIONS

SERVICE CENTER REPAIRS

Experienced engineers and technicians on staff at our full-service, in-house repair center

*InstraView*SM REMOTE INSPECTION

Remotely inspect equipment before purchasing with our interactive website at www.instraview.com ↗

WE BUY USED EQUIPMENT

Sell your excess, underutilized, and idle used equipment. We also offer credit for buy-backs and trade-ins. www.artisanng.com/WeBuyEquipment ↗

LOOKING FOR MORE INFORMATION?

Visit us on the web at www.artisanng.com ↗ for more information on price quotations, drivers, technical specifications, manuals, and documentation

Contact us: (888) 88-SOURCE | sales@artisanng.com | www.artisanng.com