



## Artisan Technology Group is your source for quality new and certified-used/pre-owned equipment

- FAST SHIPPING AND DELIVERY
- TENS OF THOUSANDS OF IN-STOCK ITEMS
- EQUIPMENT DEMOS
- HUNDREDS OF MANUFACTURERS SUPPORTED
- LEASING/MONTHLY RENTALS
- ITAR CERTIFIED SECURE ASSET SOLUTIONS

### SERVICE CENTER REPAIRS

Experienced engineers and technicians on staff at our full-service, in-house repair center

### *InstraView*<sup>SM</sup> REMOTE INSPECTION

Remotely inspect equipment before purchasing with our interactive website at [www.instraview.com](http://www.instraview.com) ↗

### WE BUY USED EQUIPMENT

Sell your excess, underutilized, and idle used equipment. We also offer credit for buy-backs and trade-ins. [www.artisanng.com/WeBuyEquipment](http://www.artisanng.com/WeBuyEquipment) ↗

### LOOKING FOR MORE INFORMATION?

Visit us on the web at [www.artisanng.com](http://www.artisanng.com) ↗ for more information on price quotations, drivers, technical specifications, manuals, and documentation

**Contact us:** (888) 88-SOURCE | [sales@artisanng.com](mailto:sales@artisanng.com) | [www.artisanng.com](http://www.artisanng.com)

**PCL-816/814B**  
MODULAR DA&C CARD

**PCL-816/814B  
MODULAR DA&C CARD  
USER'S MANUAL**

**COPYRIGHT NOTICE**

This document has been copyrighted, 1994, by Advantech Co., Ltd. All rights are reserved. Advantech Co., Ltd. reserves the right to make improvements to the products described in this manual at any time without notice.

No part of this manual may be reproduced, copied, translated, or transmitted in any form or by any means without the prior written permission of Advantech Co., Ltd. Information provided in this manual is intended to be accurate and reliable. However, Advantech Co., Ltd. assumes no responsibility for its use, nor for any infringements upon the rights of third parties which may result from its use.

**ACKNOWLEDGEMENTS**

PC-LabCard is a trademark of Advantech Co., Ltd. IBM and PC are trademarks of International Business Machines Corporation.

MS-DOS is a trade mark of Microsoft Corporation. BASIC is a trademark of Dartmouth College.

Part No. 2003816020. 2nd Edition  
Printed in Taiwan. Nov. 1994

## TABLE OF CONTENTS

<b>CHARTER 1. QUICK START</b> .....	1
1.1. Board Layout- .....	1
1.2. Pin Connector Assignment .....	2
1.3. Quick RUN- .....	2
1.3.1. Factory Setting- .....	2
1.3.2. Run the PCL-TEST- .....	3
1.4. Quick Reference for Register Format- .....	3
<b>CHARTER 2. INTRODUCTION</b> .....	7
2.1. General Information- .....	7
2.2. Initial Inspection- .....	7
2.3. Specifications- .....	8
<b>CHARTER 3. INSTALLATION</b> .....	11
3.1. Base Address Selection- .....	11
3.2. Wait State selection- .....	12
3.3. Installation- .....	13
3.4. Pin and Slot Connector. Assignments .....	14
3.4.1. Digital I/O and Analog Input Connectors .....	14
3.4.2. Piggyback Module Slot Connectors .....	16
3.5. Software Disk- .....	21
<b>CHARTER 4. SIGNAL CONNECTION</b> - .....	23
4.1. Analog Input Connection .....	23
4.1.1. Differential Channel Connection .....	23
4.2. Digital I/O Signal Connection .....	23
<b>CHAPTERER 5. ARCHITECTURE.</b> .....	27
5.1. Register Format- .....	27
5.1.1. I/O Port Address Map- .....	27
5.2. A/D Conversion Mode- .....	41
5.3. A/D Data Format and Status Register- .....	41
5.4. MUX Setting- .....	42
5.5. Gain Setting- .....	43
5.6. Trigger Mode- .....	43
5.7. A/D Data Transfer- .....	44
5.8. How to Execute an A/D Conversion .....	45

<b>CHAPTER 6. CALIBRATION AND TEST</b>	47
6.1. Frequency of Calibration	47
6.2. Required Equipment	47
6.3. Calibrating the Analog Input	47
6.3.1. Calibration Procedure	47
<b>CHAPTER 7. TROUBLESHOOTING AND DIAGNOSIS</b>	49
<b>APPENDIX A. PROGRAMMABLE TIMER/COUNTER</b>	51
A.1. The Intel 8254	51
A.2. Counter Read/Write and Control Registers	51
A.3. Counter Operating Modes	55
A.3.1. MODE 0 - Stop on Terminal Count	55
A.3.2. MODE 1 - Programmable One-Shot	55
A.3.3. MODE 2 - Rate Generator (divide by N counter)	55
A.3.4. MODE 3 - Square Wave Rate Generator	56
A.3.5. MODE 4 - Software Triggered Strobe	57
A.3.6. MODE 5 - Hardware Triggered Strobe	57
A.4. Counter Operations	57
A.4.1. Read/Write Operation	57
A.4.2. Counter Read-Back Command	58
A.4.3. Counter Latch Operation	58

# CHAPTER 1. QUICK START

## 1.1. Board Layout

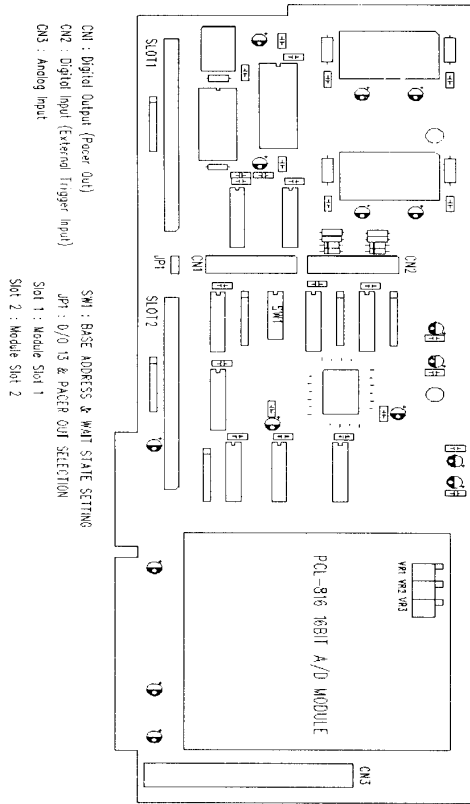

Fig 1.1

1.2. Pin Connector Assignment

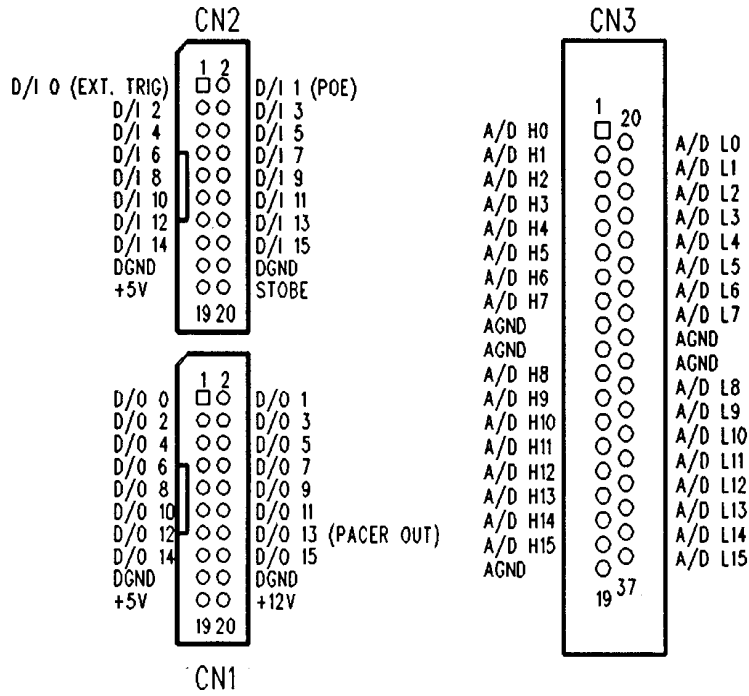

Fig 1.2

1.3. Quick RUN

1.3.1. Factory Setting

1. BaseAddress : 200(HEX)
2. Wait State : 0

**1.3.2. Run the PCL-TEST**

1. Install the PCL-816/814B in your PC.
2. Insert the Utility disk in your disk driver.
3. Run the PCLTEST.EXE.
4. Connect the signal to an analog input on CN3 (Use of Screw-terminal Board PCLD-880 is recommended).

**1.4. Quick Reference for Register Format**

1. BASE+0 (READ/WRITE) : Digital I/O Low Byte
2. BASE+1 (READ/WRITE) : Digital I/O High Byte
3. BASE+2 : N/A
4. BASE+3 : N/A
5. BASE+4 (READ/WRITE) : 8254 Counter0
6. BASE+5 (READIWRITE) : 8254 Counter 1
7. BASES+6 (READIWRITE) : 8254 Counter2
8. BASE+7 (READIWRITE) : 8254 Control Word
9. BASE+8

READ : A/D low byte data  
WRITE : A/D software trig

10. BASE+9

READ : A/D high byte data



WRITE :

D7	D6	D5	D4	D3	D2	D1	D0
NA	NA	NA	NA	NA	U/B	G1	G0

11. BASE+10

READ :

D7	D6	D5	D4	D3	D2	D1	D0
NA	U/B	G1	G0	CN3	CN2	CN1	CN0

WRITE : Clear Interrupt

12. BASE+11(READ/WRITE)

D7	D6	D5	D4	D3	D2	D1	D0
CH3	CH2	CH1	CH0	CL3	CL2	CL1	CL0

13. BASE+12(READ/WRITE)

D7	D6	D5	D4	D3	D2	D1	D0
DS1	DS0	INTEN	DMAEN	POE	EXT	PACER	S/W

## 14. BASE+13

READ :

D7	D6	D5	D4	D3	D2	D1	D0
DRDY	INTACT	IS1	IS0	CN3	CN2	CN1	CN0

WRITE :

D7	D6	D5	D4	D3	D2	D1	D0
NA	NA	DCH1	DCH0	NA	I2	I1	I0

## 15. BASE+14

READ :

D7	D6	D5	D4	D3	D2	D1	D0
ID7	ID6	ID5	ID4	ID3	ID2	ID1	ID0

WRITE :

D7	D6	D5	D4	D3	D2	D1	D0
NA	NA	NA	NA	NA	M2	M1	M0

16.BASE+15

READ :

D7	D6	D5	D4	D3	D2	D1	D0
NA	NA	NA	NA	ID3	ID2	ID1	ID0

WRITE :

D7	D6	D5	D4	D3	D2	D1	D0
NA	NA	NA	NA	NA	NA	S1	S0

\* For more information, please refer to Chapter 5.

\* For software driver, please refer to Software Driver Manual.

## CHAPTER 2. INTRODUCTION

### 2.1. General Information

The PCL-816/814B is a 16-bit/14-bit multi-purpose DAS (Data Acquisition System) card. It provides great flexibility for PC-based data acquisition systems by supporting a variety of piggyback DAS modules for Digital I/O, Counter/Timer, D/A and A/D applications.

The PCL-816/814B DAS card comes equipped with its own 16-bit/14-bit A/D piggyback module. Additional modules may be purchased separately. We also provide the following special function modules:

- 16-bit D/A module
- 12-bit D/A module
- 24-bit DI/O module
- 5-channel counter/timer module

### 2.2. Initial Inspection

As you unpack your PCL-816/814B, check to make sure that the following items have been included:

1. PCL-816/814B Modularized DAS Carrier Board
2. 16-Bit A/D Module (PCL-81601), or 14-Bit A/D Module (PCL-81401)
3. Utility diskette containing the software driver demonstration programs and language interfaces for C, C++, PASCAL and BASIC.
4. User's manual

When unpacking the PCL-816/814B, be sure that you avoid contact with anything that may produce a static electrical discharge. Inspect the PCL-816/814B and its A/D module for any defects, or for damage that may have occurred during shipping and handling. Your PCL-816/814B has been thoroughly inspected and tested before being shipped. If you find that this product is defective or incomplete in any manner, contact your authorized distributor or local dealer immediately.

**2.3. Specifications**Analog Input:

- Channels : 16 differential analog input channels
- Resolution : 16 bits (PCL-816)  
14 bits (PCL-814B)
- Sampling rate : 100 KHz maximum
- Accuracy : 0.003% FS +1 LSB (PCL-816 A/D Module)  
0.003% FS +1 LSB (PCL-814B A/D Module)
- Input impedance : > 10 M $\Omega$
- Connector : D37 Female Connector

Programmable Input Ranges:

- Bipolar
  - PCL-816 : +/-10 V  
+/-5 V  
+/-2.5 V  
+/-1.25 V
  - PCL-814B : +5 V  
+2.5 V  
+1.25 V  
+0.625 V
- Unipolar : 0 - +10 V  
0 - +5 V  
0 - +2.5 V  
0 - +1.25 V
- Trigger mode : Software, pacer and external trigger modes available

Digital Input:

<b>Digital Input</b>	
Channels	16
Logic level	TTL compatible
Input load	0.5 V @ 0.4 Ma (max.); 2.7 V @ 50 $\mu$ A (min.)
Connector	20-pin ribbon cable connector

Digital Output.

<b>Digital Output</b>	
Channels	16
Logic level	TTL compatible
Input load	0.5 V @ mA (sink); 2.7 V @ 0.4 mA (source)
Connector	20-pin ribbon cable connector



## CHAPTER 3. INSTALLATION

The PCL-816/814B was designed with ease of use in mind. The only parameters that have to be set are the base address and the wait state. Unlike other DA&C cards which contain many jumpers and switches that must be set manually, all hardware functions of the PCL-816/814B are software programmable.

### 3.1. Base Address Selection

- I/O Port Address Selection

It is important to select an appropriate I/O port address for the PCL-816/814B, in order to avoid conflicts which might occur during input/output operations on the PC bus. The PCL-816/814B utilizes 16 consecutive I/O address locations within the PC's bus architecture. Valid addresses (hexadecimal) range from 100 to 3F0. Some of these addresses may be used by devices which already exist on the bus. Exceptional care should therefore be exercised when selecting the appropriate I/O address for your PCL-816/814B.

An eight position DIP switch, SW1, allows you to set the PCL-816/814B's I/O address (position 1 through 6). The factory default address setting is 200 (hexadecimal). The following table provides the necessary information to make an appropriate address selection (A4 through A9 correspond to the address lines of your PC bus).



I/O Address Range (hex)	1 (A9)	2 (A8)	3 (A7)	4 (A6)	5 (A5)	6 (A4)
100-10F	0	1	0	0	0	0
110-11F	0	1	0	0	0	1
.	.	.	.	.	.	.
.	.	.	.	.	.	.
*200-20F	1	0	0	0	0	0
210-21F	1	0	0	0	0	1
.	.	.	.	.	.	.
.	.	.	.	.	.	.
300-30F	1	1	0	0	0	0
.	.	.	.	.	.	.
.	.	.	.	.	.	.
3F0-3FF	1	1	1	1	1	1

\* = Factory default setting

0 = ON; 1 = OFF

### 3.2. Wait State selection

- Wait State Selection

When running certain applications, PCs which employ high-speed CPUs sometimes require additional wait states in order to insure that the data transfer rate is steady. (CPUs which run at speeds of less than 33MHz will not experience this problem. In general, the 33MHz speed will not require additional wait states.) The PCL-816/814B can be configured to accommodate 0, 2, 3 or 5 wait state delays. The length of the wait state can be selected from positions 7 and 8 on SW1. The table below provides the available wait state selections.

Switch Position		Number of Wait States
7 (W1)	8 (W0)	
0	0	*0
0	1	2
1	0	3
1	1	5

\* = Factory default setting

0 = ON; 1 = OFF

### 3.3. Installation

- PCL-816/814B Installation

Before installing the PCL-816/814B in the PC, make sure that the DAS modules are properly configured and installed on the carrier board.

To install the PCL-816/814B, proceed as follows:

1. Make sure that your PC and peripheral devices are powered off and that their power cords have been disconnected.
2. Remove the chassis cover.
3. Locate a vacant expansion slot on your passive backplane that will accommodate the full-sized PCL-816/814B board.
4. Insert the carrier board into the expansion slot. Use the retaining bracket as a guide between the chassis rear panel and the base of the backplane.

5. Once the PCL-816/814B is firmly inserted into the expansion slot, secure the carrier board to the chassis by screwing down the retaining bracket to the chassis rear panel.
6. Replace the chassis cover.
7. Connect all peripheral and power cords.
8. Power on the system. Your PCL-816/814B should now be ready to run data acquisition applications.

### **3.4. Pin and Slot Connector Assignments**

The information in the following sub-sections will provide you with all pin and slot connector assignments and diagrams. You may need to refer to these sub-sections when connecting external devices and piggyback modules to the PCL-816/814B.

#### **3.4.1. Digital I/O and Analog Input Connectors**

The PCL-816/814B uses two 20-pin connectors for Digital Output (CN1) and Digital Input (CN2), and one DB-37 connector for Analog Input (CN3). Figures 3.1 and 3.2 show the pin assignments for the D/I, D/O and Analog Input connectors. Be sure to refer to these figures when connecting external devices to the PCL-816/814B.

#### **Key: (for Figure 3-1)**

D/O	Digital Output
D/I	Digital Input
DGND	Digital Ground
STROBE	External signal which latches the digital input data (active low)

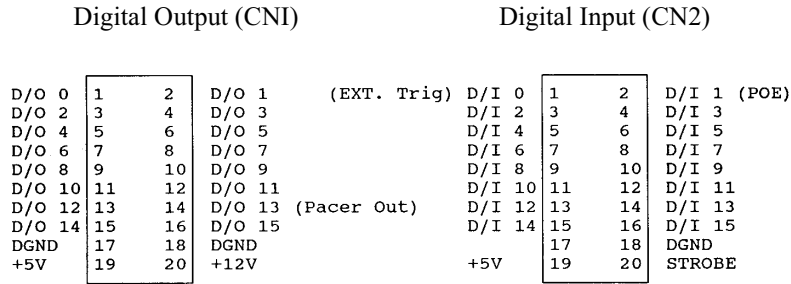

Figure 3.1

- Note:
1. CNI Pin 14 has two selectable outputs: one is D/O 13, and the other is Pacer Out. You can select the required output with JP1. Under normal conditions, JP1 should be set to select D/O 13. However, when the PCL-816/814B is used with Sample and Hold Board PCLD-787, JP1 should be set to select Pacer Out.
  2. D/I 0 and Ext. Trig are located on the same pin, CN2 Pin 1.
  3. D/I 1 and POE are located on the same pin, CN2 Pin 2.

**Key: (for Figure 3-2)**

A/D H Analog Input High (differential)  
 A/D L Analog Input Low (differential)  
 AGND Analog ground

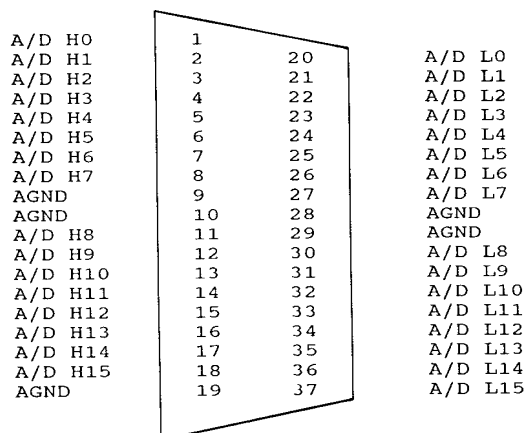

Figure 3.2

**3.4.2. Piggyback Module Slot Connectors**

The PCL-816/814B has three piggyback slot connectors (Slots 0, 1, and 2). The 72-pin connector located at Slot 0 is dedicated to the A/D module. Slots 1 and 2 are 64-pin connectors used for installing the D/A, Digital I/O, Counter/Timer, and other modules. These modules (except for the A/D module) are all interchangeable between Slots 1 and 2. The following diagrams (Figures 3.3, and 3.4) illustrate pin assignments for the slot connectors. This information is important to the operation of the PCL-816/814B DAS card, and will help you to understand its relationship with each of its piggyback modules. It is recommended that you refer to this section whenever you install and program a module.

**Key: (for Figure 3.3: slot 0)**

A/D H0 - A/D H15	Analog input high (differential)
A/D L0 - A/D L15	Analog input low (differential)
AD0 - AD15	A/D data bus
ID0 - ID3	A/D module identification code
A-D	A/D channel selection
PG0,PG1	Gain selection
U/B	Unipolar/bipolar
ADTRIG	A/D conversion trigger pulse
ADEOC	End of A/D conversion
AGND	Analog ground
DGAND	Digital ground

**Slot 0 (for the A/D module only)**

A/D H0	B1	A1	A/D L0
A/D H1	B2	A2	A/D L1
A/D H2	B3	A3	A/D L2
A/D H3	B4	A4	A/D L3
A/D H4	B5	A5	A/D L4
A/D H5	B6	A6	A/D L5
A/D H6	B7	A7	A/D L6
A/D H7	B8	A8	A/D L7
A/D H8	B9	A9	A/D L8
A/D H9	B10	A10	A/D L9
A/D H10	B11	A11	A/D L10
A/D H11	B12	A12	A/D L11
A/D H12	B13	A13	A/D L12
A/D H13	B14	A14	A/D L13
A/D H14	B15	A15	A/D L14
A/D H15	B16	A16	A/D L15
AGND	B17	A17	AGND
B	B18	A18	A
D	B19	A19	C
+5V	B20	A20	U/B
PG1	B21	A21	PG0
+15V	B22	A22	ADTRIG
ID2	B23	A23	ID3
ID0	B24	A24	ID1
-15V	B25	A25	ADEOC
DGND	B26	A26	DGND
+12V	B27	A27	+12V
AD15	B28	A28	AD14
AD13	B29	A29	AD12
AD11	B30	A30	AD10
AD9	B31	A31	AD8
AD7	B32	A32	AD6
AD5	B33	A33	AD4
AD3	B34	A34	AD2
AD1	B35	A35	AD0
-12V	B36	A36	-12V

**Figure 3.3**

**Key: (for Figure 3.4: Slots 1 and 2)**

D0 - D7	Data bus
A0 - A3	Address lines
SEL	Module active
IOR	I/O read
IOW	I/O write
ID0 - ID7	Module identification code
DRQ	DMA Request
IORY	I/O channel ready
CLKPC	Clock from PC
CLK10	10 MHz clock
IRQ	Interrupt request
AGND	Analog ground
DGND	Digital ground
ADTRIG	A/D conversion trigger pulse
RESET	Reset the module
AEN	Address enable
DMAEN	DMA enable
DMACK	DMA acknowledge
CLR-IRQ	Clear interrupt request
MODULESEL	Module select control



Slots 1 and 2 (for all other modules)

D0	B1	A1	DGND
D1	B2	A2	DGND
D2	B3	A3	DGND
D3	B4	A4	DGND
D4	B5	A5	DGND
D5	B6	A6	DGND
D6	B7	A7	DGND
D7	B8	A8	DGND
A0	B9	A9	RESET
A1	B10	A10	AEN
A2	B11	A11	A3
SEL	B12	A12	EOC
IOR	B13	A13	CLKPC
IOW	B14	A14	CLK10
ID0	B15	A15	ID4
ID1	B16	A16	ID5
ID2	B17	A17	ID6
ID3	B18	A18	ID7
DRQ	B19	A19	DMAEN
IORY	B20	A20	DMACK
IRQ	B21	A21	CLR~IRQ
+5V	B22	A22	+5V
+12V	B23	A23	+12V
-12V	B24	A24	-5V
+15V	B25	A25	+15V
AGND	B26	A26	AGND
-15V	B27	A27	-15V
ADTRIG	B28	A28	MODULSEL
	B29	A29	-12V
	B30	A30	
	B31	A31	
AGND	B32	A32	

Figure 3.4

**3.5. Software Disk**

A floppy disk containing utility software is included with each PCL-816/814B to minimize your application programming effort, and support the PCL-816/814B calibration. The utility programs include:

1. A comprehensive I/O driver for A/D, D/A, Digital I/O and Counter applications. This driver allows you to use standard functions, written in common programming languages, to operate the PCL-816/814B without going into detailed register control. Languages supported by the software driver include BASICA, GWBASIC, QUICKBASIC, Microsoft C/C++ and PASCAL, Turbo C/C+ +, Borland C/C+ + and Turbo PASCAL. Please refer to the Software Drivers User's Manual for more information.
2. Demonstration programs.
3. Calibration program.
4. Test program.

It is strongly recommended that you make a working copy from the master disk and save the master disk in a safe place. You may use the DOS COPY or DISKCOPY commands to copy the disk files to another floppy disk, or use the COPY command to copy the files to a hard disk.



## CHAPTER 4. SIGNAL CONNECTION

Correct signal connection is one of the most important factors in ensuring that your application system sends and receives data correctly. Good signal connections will avoid a lot of unnecessary problems and possible costly damage to your valuable personal computer and associated hardware. This chapter provides some useful information on signal connection arrangements in different types of data acquisition applications.

### 4.1. Analog Input Connection

#### 4.1.1. Differential Channel Connection

The differential input configuration has two signal wires for each channel. This type of input responds only to the voltage difference between these two wires, the High and Low inputs. If the signal source has no connection to ground, it is called a "floating source". In this case, a connection must exist between Low and Ground in order to define a common reference point. To measure a floating source, the input channel should be connected as shown below:

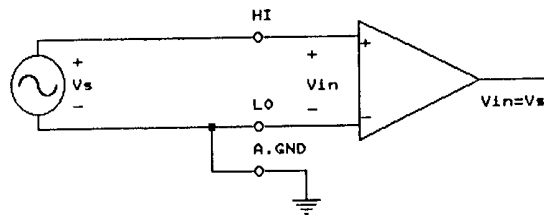

If the signal source has one side connected to a local ground, the signal source ground and the PCL-816/814B ground will not be at exactly the same voltage as they are connected through the ground return of the equipment and building wiring. The difference between these ground voltages forms a common mode voltage.

To avoid ground loop noise effect, the signal ground should be connected to the Low input signal. The Low input should not be connected to the PCL-816/814B ground directly. In some cases, a wire connection between the PCL-816/814B ground and signal source ground may be necessary. The following two diagrams illustrate both the correct and incorrect connections for a differential input with a local ground.

- Correct connection:

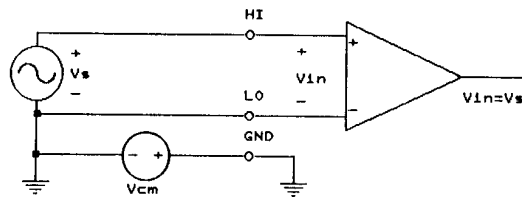

- Incorrect connection:

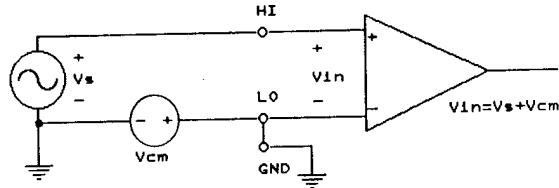

The PCLD-774 analog expansion board is designed to accommodate multiple external signal-conditioning daughter boards, such as PCLD-779 and PCLD-789. Featuring five sets of on-board 20-pin header connectors, the PCLD-774 introduces a new star-type architecture which allows cascading of multiple signal-conditioning daughter boards. The signal-attenuation and current-loading problems of normal cascading are solved by this unique arrangement.

For information on these products, please contact your local PC-LabCard sales representative.

#### 4.2. Digital I/O Signal Connection

The PCL-816/814B has 16 digital input and 16 digital output channels. The digital I/O levels are TTL compatible. To transmit or receive digital signals to or from other TTL devices, the connection should be as shown:

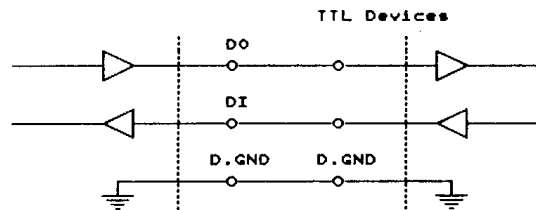

To receive an OPEN/SHORT signal from a switch or relay, a pull-up resistor must be added to ensure that the input is held HIGH when the contact is open.

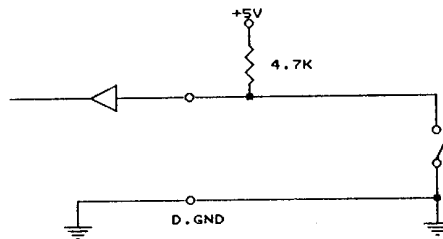



## CHAPTER 5. ARCHITECTURE

### 5.1. Register Format

This section has been written for those users who wish to design their own software drivers, instead of using the one provided with the PCL-816/814B. The following table provides a summary of the port address map. The functions of each address and a detailed data format of each register are given in the following section.

#### 5.1.1. I/O Port Address Map

Location	Module Selected Read	Write
BASE+0	Module-0 D/I Low Byte	D/O Low Byte
BASE+1	Module-0 D/I High Byte	D/O High Byte
BASE+2	Module-0 N/A	N/A
BASE+3	Module-0 N/A	N/A
BASE+4	Module-0 Counter 0	Counter 0
BASE+5	Module-0 Counter 1	Counter 1
BASE+6	Module-0 Counter 2	Counter 2
BASE+7	Module-0 Counter Readback	Counter Control
BASE+8	A/D Low Byte	Software A/D Trigger
BASE+9	A/D High Byte	A/D Range Control
BASE+10	Current Channel Status	Clear Interrupt Request



BASE + 11	MUX Scan Channel Status	Scan Channel Setting
BASE + 12	Control	Control
BASE + 13	Status	DMA/IRQ Channel Setting
BASE + 14	Carrier I.D. Code	Module Interrupt Mask Control
BASE + 15	Module I.D. Code	Module Selection

#### 1. Digital I/O Registers (BASE+0, 1; WRITE, READ)

The PCL-816/814B offers 16 digital input and 16 digital output channels. These I/O channels use the input and output ports at addresses BASE+0 and BASE+1 (Module-0). The data format of each port is as follows:

\* Data Format:

BASE+0 (Read port) : D/I low byte

D7	D6	D5	D4	D3	D2	D1	D0
DI7	DI6	DI5	DI4	DI3	DI2	DI1	DI0

BASE+0 (Write port) : D/O low byte

D7	D6	D5	D4	D3	D2	D1	D0
DO7	DO6	DO5	DO4	DO3	DO2	DO1	DO0

BASE+1 (Read port) : D/I high byte

D7	D6	D5	D4	D3	D2	D1	D0
DI15	DI14	DI13	DI12	DI11	DI10	DI9	DI8

BASE+1(Write port) : D/O high byte

D7	D6	D5	D4	D3	D2	D1	D0
DO15	DO14	DO13	DO12	DO11	DO10	DO9	DO8

2. 8254 Counter Registers (BASE+4, 5, 6, 7; WRITE, READ)

BASE+4	8254 Counter #0 Register (Read/Write)
BASE+5	8254 Counter #1 Register (Read/Write)
BASE+6	8254 Counter #2 Register (Read/Write)
BASE+7	Counter Read-back Register (Read)
BASE+7	Counter Control Register (Write)

The PCL-816/814B is equipped with an INTEL 8254 timer/counter chip. The 8254 has three counters. The PCL-816/814B uses counter #0 to generate the trigger pulse for the A/D chip. Counter #0 should be programmed as Mode 1 (one-shot mode). The following instructions are recommended:

```

OUT  BASE+7, &H32    ;Set Counter #0 as Mode 1
OUT  BASE+4, &H0A    ;Write low byte first
OUT  BASE+4, 0       ;Write high byte
(Program counter 0 as a 1 uS one-shot generator)

```

**Note:** Take care to program the 8254 counter 0 exactly as described in the steps above, otherwise the PCL-816/814B will not perform the required data acquisition tasks.

Counter #1 and Counter #2 are used to generate the pacer clock signal. Programming the desired pacer clock rate is a simple procedure. The following formula illustrates the pacer clock calculation:

$$\text{Pacer rate} = 10\text{MHz}/(\text{C1}*\text{C2})$$

Where:

C1 = 16-bit data for Counter 1, Ranges 2 to 65535.

C2 = 16-bit data for Counter 2, Ranges 2 to 65535.

The manufacturer recommends using the following programming instructions with the pacer clock rate:

```
OUT BASE+7, &H76 ;Set Counter #1 as Mode 3
OUT BASE+S, C1_Low ;Write C1's low byte
OUT BASE+S, C1_High ;Write C1's high byte
OUT BASE+7, &HB6 ;Set Counter #2 as Mode 3
OUT BASE+B, C2_Low ;Write C2's low byte
OUT BASE+6, C2_High ;Write C2's high byte
```

\*\*\* For more information about programming the Intel 8254 timer/counter, please refer to Appendix A.

### 3. A/D Data Registers (BASE+8, 9; READ)

\* Data Format:

BASE+8 : A/D low byte

D7	D6	D5	D4	D3	D2	D1	D0
AD7	AD6	AD5	AD4	AD3	AD2	AD1	AD0

BASE+9 : A/D high byte

D7	D6	D5	D4	D3	D2	D1	D0
AD15	AD14	AD13	AD12	AD11	AD10	AD9	AD8

## 4. Software A/D Trigger (BASE+8; WRITE)

Any value written to the register BASE+8 will trigger the A/D module, causing one data conversion.

\* Please refer to Base+12 for Trigger Mode Setting.

## 5. A/D Range Control (BASE+9, WRITE)

\* Data Format:

BASE+9 :

D7	D6	D5	D4	D3	D2	D1	D0
NA	NA	NA	NA	NA	U/B	G1	G0

	U/B	G1	G0	Input Range
BP :	0	0	0	$\pm 10$ V
	0	0	1	$\pm 5$ V
	0	1	0	$\pm 2.5$ V
	0	1	1	$\pm 1.25$ V
UP :	1	0	0	0 -- 10 V
	1	0	1	0 -- 5 V
	1	1	0	0 -- 2.5 V
	1	1	1	0 -- 1.25 V

**PCL-816 16-BIT MODE CODING FORMAT**

Unipolar Input Voltage	Offset Binary	Bipolar Input Voltage
> (FS-1.5 LSB)	FFFF	> (FS-1.5 LSB)
FS-1.5 LSB	FFFF ---- FFFE	FS-1.5 LSB
FS/2-0.5 LSB	8000 ---- 7FFF	-0.5 LSB
+0.5 LSB	0001 ---- 0000	-FS+0.5 LSB
< (+0.5 LSB)	0000	< (-FS+0.5 LSB)

( FS = Full Scale Range)

When using our PCL-81401 14 Bit A/D Module, the data format for the A/D Range Control byte is as follows:

BASE+9 :

D7	D6	D5	D4	D3	D2	D1	D0
NA	NA	NA	NA	NA	U/B	G1	G0

	U/B	G1	G0	Input Range
BP :	0	0	0	$\pm 5$ V
	0	0	1	$\pm 2.5$ V
	0	1	0	$\pm 1.25$ V
	0	1	1	$\pm 0.625$ V
UP :	1	0	0	0 -- 10 V
	1	0	1	0 -- 5 V
	1	1	0	0 -- 2.5 V
	1	1	1	0 -- 1.25 V

### PCL-814B 14-BIT MODE CODING FORMAT

Unipolar Coding (Straight Binary)		Bipolar Coding (Two's Complement)	
V <sub>in</sub>	Output Code	V <sub>in</sub>	Output Code
0	000...0	-FS	100...0
FS/2	100...0	-1 LSB	111...1
FS-1 LSB	111...1	0	000...0
		FS/2	010...0
		FS-1 LSB	011...1

(FS = Full Scale Range)

- Note:**
1. When you want to assign the gain setting for a channel, you must use Base+11 to assign the channel first.
  2. For PCL-814B, unipolar and bipolar inputs cannot be mixed in auto-channel scan mode. Input must be either all bipolar or unipolar.

## 6. Current A/D Channel Configuration Register (BASE+10; READ)

\* Data Format:

BASE+10 :

D7	D6	D5	D4	D3	D2	D1	D0
NA	U/B	G1	G0	CN3	CN2	CN1	CN0

\* Legend:

UIB:        0 = Bipolar  
               1 = Unipolar

G1, G0:                Gain selection (refer to BASE+9)

CN3 to CN0:        Current channel number

## 7. Clear INT register (BASE+10; WRITE)

Any value written to the register BASE+10 will clear the interrupt active flag. The PC-816/814B is then ready to accept the next interrupt request.

## 8. MUX Scan Register (BASE+11; WRITE, READ)

\* Data Format:

BASE + 11 :

D7	D6	D5	D4	D3	D2	D1	D0
CH3	CH2	CH1	CH0	CL3	CL2	CL1	CL0

\* Legend:

CH3 to CH0 - Stop scan channel number.

CL3 to CL0 - Start scan channel number

9. Control register (BASE+12, WRITE, READ)

\* Data Format:

BASE+12 :

D7	D6	D5	D4	D3	D2	D1	D0
DS1	DS0	INTEN	DMAEN	POE	EXT	PAECR	S/W

\* Legend:

S/W = 1, S/W trig enable

S/W = 0, S/W trig disable

PACER = 1, PACER trig enable

PACER = 0, PACER trig disable

EXT = 1, EXT. trig enable

EXT = 0, EXT. trig disable

( Note : EXT. trig comes from DI0 )

POE : Pacer out enable control

POE = 0, Pacer enabled

POE = 1, Pacer is controlled by DI1. If DI1 is connected to TTL low level, the Pacer will be held. This means that the analog source cannot go into A/D conversion.



Under normal conditions, DI1 will be pulled high.

DMAEN : DMA transfer control

DMAEN = 0, DMA transfer disabled

DMAEN = 1, DMA transfer enabled

**Note:** When the DMA transfer function is enabled, the INT for Terminal Count (TC) only is also automatically enabled. The DMA's terminal count generates INT when the specified number of bytes have been transferred.

INTE : Disable/Enable PCL-816/814B to generate interrupt.

INTE = 0, disables the function of interrupts. No interrupt signal can be sent to the PC bus.

INTE = 1, enables the function of an interrupt when any module sends an interrupt signal .

DS1 to DS0 - DMA Source Selected

0 0 : A/D module

0 1 : Piggyback Module #1

1 0 : Piggyback Module #2

1 1 : invalid

The DMA mode AI sampling can only be operated on the ISA bus of a P3\* motherboard. For platforms that are using P4\* motherboard or above, the DMA mode AI sampling of Advantech's ISA cards will not work.

\*Note: P3 = Pentium III microprocessor from Intel

P4 = Pentium IV microprocessor from Intel

We recommend the customer use Intel P3-installed PC to work with Advantech's ISA cards for high-speed DMA AI sampling.

## 10. DMA/IRQ Channel Setting Register (BASE+13, WRITE)

\* Data Format:

BASE+13 :

D7	D6	D5	D4	D3	D2	D1	D0
NA	NA	DCH1	DCH0	NA	I2	I1	I0

\* Legend:

I2 to I0 - Interrupt level selection.

INT2	INT1	INT0	Interrupt Level
0	0	0	N/A
0	0	1	N/A
0	1	0	IRQ2
0	1	1	IRQ3
1	0	0	IRQ4
1	0	1	IRQ5
1	1	0	IRQ6
1	1	1	IRQ7

DCH1 to DCH0 - DMA channel selection

0 0 = N/A  
 0 1 = Use DMA Channel 1  
 1 0 = N/A  
 1 1 = Use DMA Channel 3

## 11. A/D Status Register (BASE+13, READ)

\* Data Format:

BASE + 13

D7	D6	D5	D4	D3	D2	D1	D0
DRDY	INTACT	IS1	IS0	CN3	CN2	CN1	CN0

\* Legend:

DRDY : A/D Data Ready Flag of a Conversion

DRDY = 1, means the A/D data has been read.

DRDY = 0, means the A/D data is ready for reading.  
(When you read the Base+8 or Base+9, then this bit will be set to 1 until new A/D Data has been loaded).

INTACT : Interrupt active flag

INTACT = 0, means the PCL-816/814B has not generated an interrupt. If the INT function is enabled, then this function will be waiting for an interrupt.

INTACT = 1, means that if the PCL-816/814B generates an interrupt, then this bit will be set to 1. INTACT must be cleared to 0 before accepting the next interrupt. This is accomplished by writing any value to base +10 of the PCL-816/814B.

You can find the interrupt source by way of reading ISI, IS0 (Interrupt Source ID Code).

IS1, IS0 : Interrupt source ID code.

0 0 : Slot 0

0 1 : Slot 1

1 0 : Slot 2

1 1 : DMA (TC)

CN3 to CN0 : Next channel to be converted.

## 12. Carrier Board ID Code Register (BASE+14, READ)

\* Data Format

BASE+14 :

D7	D6	D5	D4	D3	D2	D1	D0
ID7	ID6	ID5	ID4	ID3	ID2	ID1	ID0

You can get the Carrier Board ID Code by reading BASE+14 twice. If on the first reading, the byte you got was 81 (HEX), then the second byte will be 60 (HEX). On the other hand, if the first byte you got was 60 (HEX), then the second byte will be 81 (HEX).

## 13. Module Interrupt Mask Setting (BASE+14, WRITE)

\* Data Format

BASE + 14 :

D7	D6	D5	D4	D3	D2	D1	D0
NA	NA	NA	NA	NA	M2	M1	M0

\* Legend :

M0 : Slot 0 interrupt mask bit.

M0 = 0, Slot 0 interrupt function enabled.

M0 = 1, Slot 0 interrupt function disabled.

M1 : Slot 1 interrupt mask bit.

M1 = 0, Slot 1 interrupt function enabled.

M1 = 1, Slot 1 interrupt function disabled.

M2 : Slot 2 interrupt mask bit.

M2 = 0, Slot 2 interrupt function enabled.

M2 = 1, Slot 2 interrupt function disabled.

#### 14. Module ID Code Register (BASE+15, READ)

\* Data Format:

BASE + 15 :

D7	D6	D5	D4	D3	D2	D1	D0
NA	NA	NA	NA	ID3	ID2	ID1	ID0

\* On board A/D module ID code list:

A/D Module	ID3	ID2	ID1	ID0
14 Bit	1	0	0	0
16 Bit	1	1	0	0

GP Module	ID3	ID2	ID1	ID0
24 Bit DIO Module	0	0	0	1
Timer/Counter Module	0	0	1	0
12 Bit D/A Module	0	0	1	1
16 Bit D/A Module	0	1	0	0

\* Legend:

ID3 to ID0 - Active module identify code.

### 15. Module Selection register (BASE+15, WRITE)

The Module Select register is a write-only register using address BASE+15. This register can select the active module on the PCL-816/814B.

\* Data Format:

BASE+15 :

D7	D6	D5	D4	D3	D2	D1	D0
NA	NA	NA	NA	NA	NA	S1	S0

S1 S0 Selected Module

```

-----
0 0 On board A/D module
0 1 GP Module 1
1 0 GP Module 2
1 1 Not available

```

### 5.2. A/D Conversion Mode

This section provides a complete explanation of how to use the PCL-816/814B A/D conversion functions. The following topics are covered: A/D data format, input range selection, MUX multiplexer channel control, trigger modes and data transfer.

### 5.3. A/D Data Format and Status Register

An 8 bit register is too small to accommodate 16/14 bit A/D conversions performed by the PCL-816/814B. This problem is solved by storing A/D data in two 8-bit registers located at addresses BASE +8 and BASE +9. The A/D low byte data are located in positions D0 (AD0) through D7 (AD7) of BASE +8. A/D high byte data are located in positions D0 (AD8) through D7 (AD15) of BASE +9. The least significant bit is AD0, and the most significant bit is AD15.

The data format of the A/D data registers is given below:

- A/D Low byte.

BASE+8 :

D7	D6	D5	D4	D3	D2	D1	D0
AD7	AD6	AD5	AD4	AD3	AD2	AD1	AD0

- A/D High byte.

BASE+9 :

D7	D6	D5	D4	D3	D2	D1	D0
AD15	AD14	AD13	AD12	AD11	AD10	AD9	AD8

#### 5.4. MUX Setting

- \* Data Format :

BASE+10 :

D7	D6	D5	D4	D3	D2	D1	D0
CH3	CH2	CH1	CH0	CL3	CL2	CL1	CL0

## 5.5. Gain Setting

\* Data Format :

BASE+B

D7	D6	D5	D4	D3	D2	D1	D0
NA	NA	NA	NA	NA	U/B	G1	G0

## 5.6. Trigger Mode

The PCL-816/814B A/D conversions can be triggered in any one of three ways: software trigger, on-board programmable pacer or external pulse trigger. Each is explained below:

### 1. Software trigger

This feature is controlled by software commands issued by the application program. Writing to register BASE +8 with any value causes a software trigger to be executed. This mode is not normally used in high speed A/D applications, due to the short execution times of the application programs.

### 2. On-board programmable pacer

The PCL-816/814B incorporates the INTEL 8254 Programmable Interval Timer/Counter. In the pacer trigger mode, Counters 1 and 2 of the INTEL 8254 are configured as one pacer, offering precisely timed A/D converter trigger pulses. Speeds range between 0.5 MHz and 35 minutes per pulse (For details on how to use the INTEL 8254 timer/counter, please refer to Appendix A). The pacer trigger mode is ideal for interrupt and DMA data transfer, which is normally used in A/D applications requiring high conversion speeds.

### 3. External pulse trigger

The PCL-816/814B direct external trigger pulses are controlled through EXT.TRG (connector CN2 DI0). This mode is used mostly in A/D applications requiring A/D conversions which are not measured



periodically. Instead, they are measured conditionally (e.g., in thermocouple temperature control).

### **5.7. A/D Data Transfer**

There are three possible ways to execute the PCL-816/814B A/D data transfer: (1) Program control (2) Interrupt routine and (3) Direct memory access.

#### **1. Program control**

The program control method of data transfer uses the "polling" concept, in which each device is checked to see if data is to be transferred. After the A/D converter has been triggered, the application program checks the data ready (DRDY) bit of BASE + 13. If the DRDY bit is 0, the converted data is moved from the A/D data register to computer memory by application program control.

#### **2. Interrupt routine**

When employing the interrupt routine method of transfer, data is sent from the A/D data registers to a previously defined memory segment by the interrupt service routine. At the start of each conversion, the A/D Trigger signal generates an interrupt which enables the interrupt service routine to perform the transfer. Before using this interrupt routine, the following parameters must be specified:

- a. The interrupt control bit of the control register (BASE +12).
- b. The IRQ level selection BASE +13.

A write action to the A/D status register address (BASE +10) with any value resets the PCL-816/814B interrupt request and re-enables the PCL-816/813B interrupt.

#### **3. Direct memory access (DMA)**

DMA transfers A/D data from the PCL-816/814B hardware device to the PC system memory without operating the system CPU. DMA is very useful in high speed data transfer, but is complicated to operate. It is necessary to

set the DMA channel selection (BASE +13), the DMA enable bit in the PCL-816/814B control register (BASE +12) and the 8237 DMA controller registers before performing DMA operations. We recommend that the PCL-816/814B software driver be used for DMA operation. For more information regarding DMA operations, please refer to any data book for the 8237 DMA controller.

### **5.8. How to Execute an A/D Conversion**

I/O port instructions used by D&A programs may be written either directly or by first invoking the PCL-816/814B driver. The latter approach is recommended, as it enhances program performance and makes programming easier. In the last section of this chapter, step-by-step implementation procedures for different AD operations are outlined.

Data transfer using the methods of pacer trigger and program control may be accomplished without the PCL-816/814B driver, as follows:

- Step 1 : Set the input channel by specifying the Mux scan range.
- Step 2 : Write the pacer trigger mode to the control register, Base + 12.
- Step 3 : Wait for the DRDY by reading the BASE +13 register DRDY bit.
- Step 4 : Read data from the A/D converter by reading the A/D data registers (BASE +8 and +9).
- Step 5 : Convert data by converting the binary A/D data to an integer.



## CHAPTER 6. CALIBRATION AND TEST

### 6.1. Frequency of Calibration

Since every card is thoroughly tested and calibrated in our factory, your new PCL-816/814B should not require calibration before initial use. Under normal conditions, a calibration should be performed every 6 months to one year; if, however, frequent variations in temperature or humidity are common, recalibrate at least once every three months.

### 6.2. Required Equipment

Ideally, you will need a precision voltage source and connecting cables. If you do not have a precision voltage source, our 16-Bit D/A module is recommended.

### 6.3. Calibrating the Analog Input

The A/D is calibrated by applying a known voltage to Channel 0 and adjusting the onboard VRs (variable resistors) for gain and offset (refer to Fig 6.1 for VRs location).

#### 6.3.1. Calibration Procedure

The entire calibration procedure is included on the utility disk. The information can be accessed by running the CALB816.EXE/CALB814B.EXE file. Please refer to this automated procedure if you want to calibrate your PCL-816/814B.

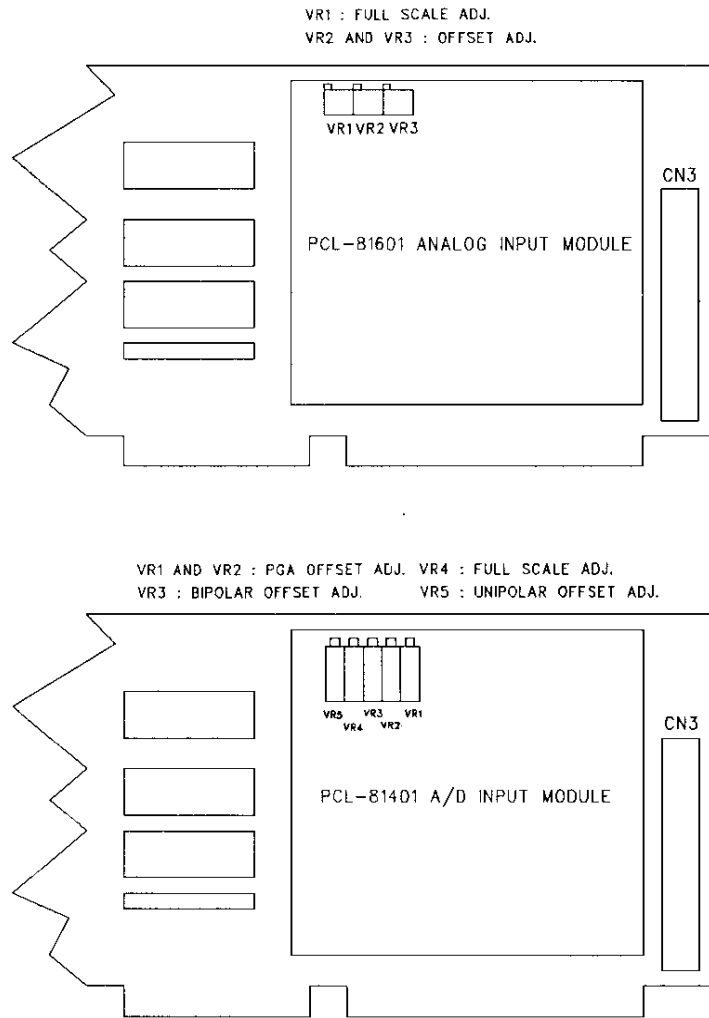

Fig 6.1

## CHAPTER 7. TROUBLESHOOTING AND DIAGNOSIS

Should problems arise when using the PCL-816/814B MODULARIZED DA&C CARD, the following list of troubleshooting procedures should be helpful in identifying the cause and implementing a solution.

- (1) Check the PC bus power, especially the +12 volt and +5 volt supplies.
- (2) Check the voltage of the signal between the AIHn and AILn. This voltage should not exceed the full scale input range of the card.
- (3) Check the voltage between your signal ground and the card's ground. It should be 0 volts.
- (4) Check other boards in your PC for Address, DMA and Interrupt level conflicts.
- (5) Refer to our example programs on the utility disk for techniques and as a guide to check your programs again.



## APPENDIX A. PROGRAMMABLE TIMER/COUNTER

### A.1. The Intel 8254

The PCL816/814B uses the Intel 8254 programmable interval timer/ counter Version 2. The 8254 is a very popular timer/counter device consisting of three independent 16 bit down counters. Each counter has a clock input, control gate and an output. It can be programmed to have a count from 2 up to 65535.

The maximum clock input frequency is 10 MHz for Version 2 of the 8254. The PCL816/814B provides a 10 MHz input frequency through an on-board crystal oscillator.

Counters 1 and 2 are cascaded and operated in a divide-by configuration. Counter 1 input is connected to the 10 MHz input frequency and the output of Counter 1 is connected to the input of Counter 2. The output of Counter 2 is internally configured to provide trigger pulses to the A/D converter, but it is also available for other uses. CNI Pin 13 may be configured as either DO13 or Pacer Out by means of jumper JP1.

### A.2. Counter. Read/Write and Control Registers

The 8254 programmable interval timer uses four registers at address BASE+4, BASE+5, BASE+6 and BASE+7. The function of each register is as follows:

BASE+4	Counter 0 Read/Write
BASE+5	Counter 1 Read/Write
BASE+6	Counter 2 Read/Write
BASE+7	Counter Control Word



Since the 8254 counter uses a 16 bit structure, read/write data is split into the least significant byte (LSB) and the most significant byte (MSB). It is important to ensure that your read/write operations are in pairs, and to keep track of the byte order.

The data format of the control register is:

BASE+ 7 : Control

D7	D6	D5	D4	D3	D2	D1	D0
SC1	SC0	RW1	RW0	M2	M1	M0	BCD

Legend :

SCI & SCO - Select Counter

SC1	SC0	Counter
0	0	0
0	1	1
1	0	2
1	1	Read-back command

RW1 & RW0 - Select the Read/Write operation.

RW1	RW0	Operation
0	0	Counter latch
0	1	Read/Write LSB
1	0	Read/Write MSB
1	1	Read/Write LSB first, then MSB.

M2, M1 and M0 - Select the Operating Mode.

M2	M1	M0	Mode
0	0	0	0 Interrupt on terminal count
0	0	1	1 Programmable one shot
X	1	0	2 Rate generator
X	1	1	3 Square wave rate generator
1	0	0	4 Software triggered strobe
1	0	1	5 Hardware triggered strobe

BCD - Select Binary or BCD Counting

BCD	Type
0	Binary Counter 16-bits
1	Binary Coded Decimal (BCD) Counter

If the module is set to binary, the count can be any number from 0 up to 65535. If the module is set to BCD (binary coded decimal), the count can be set as any number from 0 to 9999

If both the SC1 and SC0 bit are set to 1, the counter control register is in read-back command. The data format of the control register then becomes:

BASE+ 7

D7	D6	D5	D4	D3	D2	D1	D0
1	1	CNT	STA	C2	C1	C0	X

Legend :

CNT = 0 - Latch count of selected counter(s).

STA = 0 Latch status of selected counter(s).

C2, C1 and C0 Select counter for a read-back operation

C2 = 1 select Counter 2

C1 = 1 select Counter 1

C0 = 1 select Counter 0

If SCI and SC0 are both set to I and STA is set to 0. the counter read/write register selected by C2 to C0 contains the return status byte. The data format of the counter read/write register then becomes:

BASE + 4/5/6

D7	D6	D5	D4	D3	D2	D1	D0
OUT	NC	RW1	RW0	M2	M1	M0	BCD

Legend:

OUT - Counter output current state.

NC - Null count indicates when the last count written to the counter register has been loaded into the counting element.

### **A.3. Counter Operating Modes**

#### **A.3.1. MODE 0 - Stop on Terminal Count**

The output will be initially low after setting this mode of operation. After the count is loaded into the selected count register, the output will remain low and the counter will count. When terminal count is reached, the output will go high and will remain high until the selected counter is reloaded with the mode or a new count is loaded. The counter continues to decrement after terminal count has been reached. Rewriting a counter register during counting generates the following results.

1. Write the first byte stops the current counting.
2. Write the second byte starts the new count.

#### **A.3.2. MODE 1 - Programmable One-Shot**

The output will go low on the count following the rising edge of the gate input. The output will go high on the terminal count. If a new count value is loaded while the output is low, it will not affect the duration of the one-shot pulse until the succeeding trigger. The current count can be read at any time without affecting the one-shot pulse. The one-shot is re-triggerable, thus the output will remain low for the full count after any rising edge on the gate input.

#### **A.3.3. MODE 2 – Rate Generator (divide by N counter)**

The output will be low for one period of the input clock. The period from one output pulse to the next equals the number of input counts in the counter register. If the counter register is reloaded between output pulses, the present period will not be affected, but the subsequent period will reflect the new value.

The gate input, when low, will force the output high. When the gate input goes high, the counter will start from the initial count. Therefore the gate input can be used to synchronize the counter.

When this mode is set, the output will remain high until the count register is loaded. The output can also be synchronized by software.

#### **A.3.4. MODE 3 - Square Wave Kate Generator**

Mode 3 is similar to Mode 2, except that the output will remain high until one half the count has been completed (for even numbers), and will go low for the other half of the count. This is accomplished by decrementing the counter by two on the falling edge of each clock pulse. When the counter reaches the terminal count, the state of the output is changed, the counter is reloaded with the full count and the whole process is repeated.

If the count is odd and the output is high, the first clock pulse (after the count is loaded ) decrements the count by 1. Subsequent clock pulses decrement the count by 2. After timeout, the output goes low and the full count is reloaded. The first clock pulse (following the reload) decrements the counter by 3. Subsequent clock pulses decrement the count by two until timeout. Then the whole process is repeated. In this way, if the count is odd, the output will be high for  $(N+1)/2$  counts and low for  $(N-1)/2$  counts.

**A.3.5. MODE 4 - Software Triggered Strobe**

After the mode is set, the output will be high. When the count is loaded, the counter will begin counting. On terminal count, the output will go low for one input clock period, after which it will again go high.

If the count register is reloaded during counting, the new count will be loaded on the next CLK pulse. The count will be inhibited while the GATE input is low.

**A.3.6. MODE 5 - Hardware Triggered Strobe**

The counter will start counting after the rising edge of the trigger input and will go low for one clock period when the terminal count is reached. The counter is retriggerable

**A.4. Counter Operations****A.4.1. Read/Write Operation**

For each counter, the type of read/write operation, operating mode and counter type must all be properly specified in the control byte, and the control byte must be written before the initial count is written.

Since the control byte register and all three counter read/write registers have separate addresses, and each control byte specifies the counter it applies to (by SC1 & SC0), no instructions on the operating sequence are required. Any programming sequence following the 8254 conventions is acceptable.

There are three types of counter operation: read/load LSB, read/load MSB and read/load LSB followed by MSB. It is important to ensure that your read/write

operations are in pairs, and to keep track of the byte order.

#### **A.4.2, Counter Read-Back Command**

The 8254 counter read-back command allows users to check the count value, programmed mode, and current states of the OUT pin and Null Count flag of the selected counter(s). The command is written into the control word register and has the format shown in Section 8.2.

The read-back command may be used to latch multiple counter output latches by setting the CNT bit = 0 and selecting the desired counter(s). This single command is functionally equivalent to several counter latch commands, one for each counter latched.

The read-back command can also be used to latch status information of the selected counter(s) by setting STA hit = 0. Status must be latched to be read; the status of a counter is accessed by a read from that counter. The counter status format is shown in Section 8.2.

#### **A.4.3. Counter Latch Operation**

It is often desirable to read the value of a counter without disturbing the count in progress. Usually the method used is the counter latch command method, which allows the user to read the latched count value of the selected counter.

The 8254 supports counter latch operations in two ways. The first way is to set RW1 & RW0 to (0,0), which latches the count of the selected counter in a 16 bit hold register. The second approach is performing latch operation under the read-back command by setting SCI & SC0 to (1,1) and CNT = 0. This method has the advantage of operating several counters at the same time. A subsequent read operation on the selected counter will retrieve the held value.



## Artisan Technology Group is your source for quality new and certified-used/pre-owned equipment

- FAST SHIPPING AND DELIVERY
- TENS OF THOUSANDS OF IN-STOCK ITEMS
- EQUIPMENT DEMOS
- HUNDREDS OF MANUFACTURERS SUPPORTED
- LEASING/MONTHLY RENTALS
- ITAR CERTIFIED SECURE ASSET SOLUTIONS

### SERVICE CENTER REPAIRS

Experienced engineers and technicians on staff at our full-service, in-house repair center

### *InstraView*<sup>SM</sup> REMOTE INSPECTION

Remotely inspect equipment before purchasing with our interactive website at [www.instraview.com](http://www.instraview.com) ↗

### WE BUY USED EQUIPMENT

Sell your excess, underutilized, and idle used equipment. We also offer credit for buy-backs and trade-ins. [www.artisanng.com/WeBuyEquipment](http://www.artisanng.com/WeBuyEquipment) ↗

### LOOKING FOR MORE INFORMATION?

Visit us on the web at [www.artisanng.com](http://www.artisanng.com) ↗ for more information on price quotations, drivers, technical specifications, manuals, and documentation

**Contact us:** (888) 88-SOURCE | [sales@artisanng.com](mailto:sales@artisanng.com) | [www.artisanng.com](http://www.artisanng.com)