



Artisan Technology Group is your source for quality new and certified-used/pre-owned equipment

- FAST SHIPPING AND DELIVERY
- TENS OF THOUSANDS OF IN-STOCK ITEMS
- EQUIPMENT DEMOS
- HUNDREDS OF MANUFACTURERS SUPPORTED
- LEASING/MONTHLY RENTALS
- ITAR CERTIFIED SECURE ASSET SOLUTIONS

SERVICE CENTER REPAIRS

Experienced engineers and technicians on staff at our full-service, in-house repair center

*InstraView*SM REMOTE INSPECTION

Remotely inspect equipment before purchasing with our interactive website at www.instraview.com ↗

WE BUY USED EQUIPMENT

Sell your excess, underutilized, and idle used equipment. We also offer credit for buy-backs and trade-ins. www.artisanng.com/WeBuyEquipment ↗

LOOKING FOR MORE INFORMATION?

Visit us on the web at www.artisanng.com ↗ for more information on price quotations, drivers, technical specifications, manuals, and documentation

Contact us: (888) 88-SOURCE | sales@artisanng.com | www.artisanng.com

WebLink-2059

Web-enabled Device Connection with
PC Card

User's Manual

Copyright notice

This document is copyrighted, 2001, by Advantech Co., Ltd. All rights are reserved. The original manufacturer reserves the right to make improvements to the products described in this manual at any time without notice.

No part of this manual may be reproduced, copied, translated or transmitted in any form or by any means without the prior written permission of the original manufacturer. Information provided in this manual is intended to be accurate and reliable. However, the original manufacturer assumes no responsibility for its use, nor for any infringements upon the rights of third parties which may result from such use.

Acknowledgements

IBM, PC/AT, PS/2 and VGA are trademarks of International Business Machines Corporation.

Intel® and Pentium® are trademarks of Intel Corporation.

Microsoft Windows and MS-DOS are registered trademarks of Microsoft Corp.

C&T is a trademark of Chips and Technologies, Inc.

All other product names or trademarks are properties of their respective owners.

2nd Edition Printed in Taiwan Aug 2002

Product warranty

Advantech warrants to you, the original purchaser, that each of its products will be free from defects in materials and workmanship for one year from the date of purchase.

This warranty does not apply to any products that have been repaired or altered by persons other than repair personnel authorized by Advantech, or which have been subject to misuse, abuse, accident or improper installation. Advantech assumes no liability under the terms of this warranty as a consequence of such events.

Because of Advantech high quality-control standards and rigorous testing, most of our customers never need to use our repair service. If an Advantech product is defective, it will be repaired or replaced at no charge during the warranty period. For out-of-warranty repairs, you will be billed according to the cost of replacement materials, service time and freight. Please consult your dealer for more details. If you think you have a defective product, follow these steps:

1. Collect all the information about the problem encountered. (For example, CPU speed, Advantech products used, other hardware and software used, etc.) Note anything abnormal and list any on-screen messages you get when the problem occurs.
2. Call your dealer and describe the problem. Please have your manual, product, and any helpful information readily available.
3. If your product is diagnosed as defective, obtain an RMA (return merchandise authorization) number from your dealer. This allows us to process your return more quickly.
4. Carefully pack the defective product, a fully completed Repair and Replacement Order Card and a photocopy proof of purchase date (such as your sales receipt) in a shippable container. A product returned without proof of the purchase date is not eligible for warranty service.
5. Write the RMA number visibly on the outside of the package and ship it prepaid to your dealer.

Technical support and sales assistance

If you have any technical questions about the WebLink-2059 or any other Advantech products, please visit our support website at:

<http://www.advantech.com/support>

For more information about Advantech's products and sales information, please visit:

<http://www.advantech.com>

Contents

Chapter 1	WebLink-2059 Overview	1
1.1	Features	2
1.2	Hardware Specifications	4
1.3	Web-enabled HMI/SCADA (Advantech Studio) Features	6
1.4	Safety Precautions	6
1.5	WebLink-2059 Series	7
1.6	Chassis Dimensions	9
Chapter 2	Hardware Functionality	11
2.1	WebLink-2059 Peripherals	12
2.2	COM1~COM4: RS-232/485 Interfaces	12
2.3	LAN: Ethernet Connector	13
2.4	Power Connector	13
2.5	LED Indicators	13
2.6	PS/2 Keyboard and Mouse Connector	14
2.7	USB1 & USB2: Universal Serial Bus connectors	14
2.8	PCMCIA: PC Card Slot	14
2.9	VGA: VGA Display Connector	15
2.10	RESET: Reset Button	15
Chapter 3	Initial Setup	17
3.1	Initial Procedure	18
3.2	Insert CompactFlash Card (For WebLink-2059/BAR only)	18
3.3	Connect the power	19
3.4	WebLink-2059 IP address configuration	19
3.5	Wireless LAN IP address configuration	20
3.6	BIOS Setup and System Assignments	20

Appendix A Pin Assignments21

- A.1 Board Connectors and Jumpers 22**
- A.2 RS-232/485 Serial Port (CN6~CN9)..... 24**
- A.3 Ethernet RJ-45 Connector (LAN1) 27**
- A.4 Phoenix Power Connector (CN3) 28**
- A.5 PS/2 Keyboard and Mouse Connector (KM1) 28**
- A.6 USB Connector (CON1, CON2)..... 29**
- A.7 VGA Display Connector (JP2) 29**
- A.8 CompactFlash™ Master/Slave Jumper Setting
(JP1) 31**

Figures

Figure 1-1:	Chassis dimensions	9
Figure 2-1:	WebLink-2059 front panel	12
Figure 2-2:	WebLink-2059 rear panel	12
Figure A-1:	WebLink-2059 connector and jumper locations (Top View).....	22
Figure A-2:	WebLink-2059 connector and jumper locations (Bottom View).....	22
Figure A-3:	COM ports terminator resistor locations	25
Figure A-4:	Terminator resistor installation	25
Figure A-5:	RS-485 Wiring topology	26
Figure A-6:	RS-232 Jumper Setting	26
Figure A-7:	RS-485 Jumper Setting	27

Tables

Table 2-1:	Serial ports default setting	12
Table A-1:	WebLink-2059 connectors and jumpers	23
Table A-2:	RS-232/485 serial port pin assignments	24
Table A-3:	Jumpers to select RS-232/485	26
Table A-4:	Ethernet RJ-45 connector pin assignments	27
Table A-5:	Phoenix power connector pin assignments	28
Table A-6:	Keyboard and Mouse connector pin assignments	28
Table A-7:	USB connector pin assignments	29
Table A-8:	VGA display connector pin assignments	29
Table A-9:	VGA adaptor cable pin assignments	30

WebLink-2059 Overview

This chapter gives background information on the WebLink-2059. It shows you the WebLink-2059 overview and specifications.

Sections include:

- Introduction
- Features
- Hardware Specifications
- Web-enabled HMI/SCADA (Advantech Studio) Features
- Safety Precautions
- WebLink-2059 Series
- Chassis Dimension

Introduction

Advantech WebLink-2059 is a powerful embedded and web-enabled solution platform that connects data devices with enterprise systems. WebLink-2059 automatically captures real-time data from the plant floor and then analyzes, controls and distributes this information to enterprise systems via the Internet. You can easily access the data through graphic interfaces anytime and anywhere. Its powerful I/O connectivity easily lets the WebLink-2059 get data from the ADAM-4000/5000 series to versatile legacy controllers and 3rd party I/Os. In the event of an emergency, WebLink can broadcast alarms or notify key people via e-mail. It is possible to then access or even diagnose the system problem immediately through any browser. Using Microsoft Windows CE .NET embedded features and compact flash storage, the WebLink-2059 highly reliable platform for industrial automation with no risk of hard disk crashes.

1.1 Features

The Advantech WebLink-2059 provides users with the most requested functions as seen below:

- Windows CE-based open embedded system
- Embedded Web-enabled HMI/SCADA software
- Rich legacy controllers and OPC device connection supporting
- Alarm/Event instantly handling through email
- Reliable and Powerful Out-of-Box solution platform
- 11MHz Wireless LAN (Windows CE .NET) supported

The Advantech WebLink-2059 offers the following main features:

Embedded web-enabled HMI/SCADA software

HMI/SCADA software and HTTP v1.10 compliant (a persistent connection allows multiple downloads with less overhead, and also improves caching while making it easier to create virtual hosts) web server are established on WebLink-2059 and allow you to remotely view and control I/O data from anywhere on anytime.

Rich Legacy Controllers and OPC device connection support

With four RS-232/485 ports and industrial standard OPC server, WebLink-2059 can connect versatile I/Os and control devices including Advantech ADAM-4000, 5000 series, Allen-Bradley PLC, Mitsubishi A type & FX series PLC, Modbus RTU protocol PLC, Omron C type PLC and Profibus DP compliant device.

Alarm/Event instantly contact through email

WebLink-2059 automatically and immediately sends out e-mail to a dedicated person or address if an alarm or event of an emergency occurs.

Windows® CE-based open embedded system

With no hard disk needed, the WebLink-2059 features increased reliability. More importantly, Windows® CE .NET unfailingly performs time-sensitive tasks with deterministic responses to events. This is a key feature in most industrial applications.

Reliable and Powerful Out-of-Box solution platform

WebLink-2059 provides reputable industrial hardware with Pentium grade processor and Windows® CE-based embedded software bundled solution. This translates into long-time stability and powerful computing capability to fulfill most different applications.

Wireless LAN extension empower your networking and remote monitoring

There are two USB ports and one PC Card slot in WebLink-2059 for you to easily add peripherals such as storage devices, modems and more. Advantech also offers you Wireless LAN solution, too. The Windows® CE .NET drivers are already installed and thoroughly tested under WebLink-2059.

1.2 Hardware Specifications

CPU: NS Geode GX1-300 MHz

Chipset: NS CS5530A

BIOS: AWARD 256 KB FLASH BIOS

RAM: 64 MB SDRAM on board

VGA: Supports VGA and VESA

- Display memory: 1 ~ 4 MB share memory, set in BIOS
- CRT display mode: Non-interlaced CRT monitors resolutions up to 1280 x 1024 @ 256 colors or 1024 x 768 @ 16 bpp

Serial Port: Four RS-232/485 ports

- Controller: Oxford OX16PCI954 UARTs with 128 bytes FIFOs
- IRQ: All ports use the same IRQ assigned by BIOS
- Space reserved for termination resistors
- Automatic RS-485 data flow control
- RS-485 surge protection up to 2,000 V_{DC}
- Data bits: 5, 6, 7, 8
- Stop bits: 1, 1.5, 2
- Parity: none, even, odd
- RS-232 speed: 50~230.4Kbps
- RS-485 speed: 50~921.6Kbps
- RS-232 data signals: TxD, RxD, RTS, CTS, DTR, DSR, DCD, RI, GND

- RS-485 data signal: DATA+, DATA-, GND
- RS-232 max data distance: 50 feet (15.2 meters)
- RS-485 max data distance: 4000 feet (1220 meters)

USB interface: Two USB ports, USB OpenHCI, Rev. 1.0 compliant

Ethernet Port: One 10/100Base-T Ethernet

- LAN chip: Realtek 8139C chipset supports
- LED on the front side

PC Card: One PC Card slot

- Support CardBus (Card-32) Card and 16-bit (PCMCIA 2.1/JEIDA4.2) Card
- Support +5V, +3.3V and +12V@120mA working power

SSD: One Type I / Type II CompactFlash™ card slot inside the chassis

LED: One power LED, one HDD LED

Keyboard/Mouse connector: Mini-DIN connector supports PS/2 keyboard and a PS/2 mouse

Power supply voltage: 10-30 V_{DC}

Power Consumption: 0.6A max under +24V power input or 1.2A max. under +12V power input

Power Requirement: 1A typical under +24 V power input or 1.5 A typical under +12 V power input

Operating temperature: 0 ~ 55°F (0 ~ 131°F)

Chassis size: 164.8 mm (W) x 106.5 mm (L) x 35.5 mm (H) (6.5" x 4.2" x 1.4")

Weight: 0.8 kg

1.3 Web-enabled HMI/SCADA (Advantech Studio) Features

Graphics: Support more than 15 imported graphics formats and 40 pre-defined dynamic effects and an extensive symbol library.

Alarms: Allows sending alarms to screen, e-mail, Web browser and archive onto file, printer and SQL-database.

Trending: Keep track of process behavior Online or through historical trending

Recipes and Reports: Offers flexible, user-defined recipe groups and user-configurable reports

Input/Output: Supports 1,500 I/O tags, more than 140 devices drivers, OPC Client and various PC control packages

Math Expression: Advanced math library with more than 100 standard functions with flexible scripting language

Industry Standards Connectivity: Conform to industrial standards such as Microsoft DNA, OPC, DDE, ODBC, XML and ActiveX and integration with Microsoft Excel

Security: Multi-level security for applications, including use over Intranets and Internet

1.4 Safety Precautions

The following sections tell how to make each connection. In most cases, you will simply need to connect a standard cable. All of the connector pin assignments are shown in Appendix A.

Warning! *Always disconnect the power cord from your PC chassis whenever you are working on it. Do not connect while the power is on. A sudden rush of power can damage sensitive electronic components. Only experienced electronics personnel should open the PC chassis.*

Caution! *Always ground yourself to remove any static electric charge before touching WebLink-2059. Modern electronic devices are very sensitive to static electric charges. Use a grounding wrist strap at all times. Place all electronic components on a static-dissipative surface or in a static-shielded bag..*

1.5 WebLink-2059 Series

There are four products in WebLink-2059 series listed as below:

- **WebLink-2059/BAR:** WebLink-2059 hardware platform
- **WebLink-2059/CE:** WebLink-2059 hardware platform with Windows CE .NET OS (built in 32MB CompactFlash™ card)
- **WebLink-2059/SDA:** WebLink-2059 hardware platform with Windows CE .NET OS and Advantech Studio SCADA/HMI software (built in 32MB CompactFlash™ card)
- **WebLink-2059/SKT:** WebLink-2059/SDA with Advantech Studio Development version.

Packing list

Before installing your board, make sure that the following materials have been received:

Common parts:

- Warranty certificate
- Software Supporting CD-ROM
- 6P-6P-6P 20cm KB and PS/2 Mouse Y cable (P/N: 1652002202)
- Plug-in Block 2P Female (P/N 1652002205)
- 6P-15P 10cm VGA cable (P/N: 1703150101)
- DIN-rail mounting accessory (1997001110, 1997001120, 1997001130, 1997001140)

For WebLink-2059/CE only:

- Built in 32MB CompactFlash™ card with Microsoft Windows CE .NET OS
- End User License Agreement for Windows CE .NET

For WebLink-2059/SDA only:

- Built in 32MB CompactFlash™ card with Microsoft Windows CE .NET OS and Advantech Studio SCADA/HMI software
- End User License Agreement for Windows CE .NET
- Quick Start for Advantech Studio
- Advantech Studio Demo CD

If any of these items are missing or damaged, contact your distributor or sales representative immediately.

1.6 Chassis Dimensions

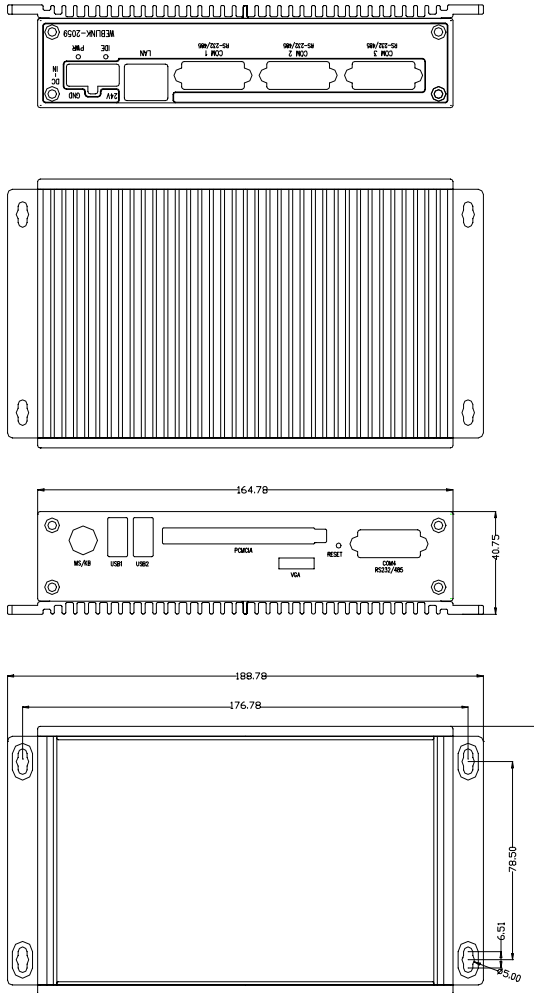

Figure 1-1: Chassis dimensions

Hardware Functionality

This chapter shows how to set up the WebLink-2059's hardware functions, including connecting peripherals, switches and indicators.

Sections include:

- WebLink-2059 Peripherals
- COM1~COM4: RS-232/485 Interfaces
- LAN: Ethernet Connector
- Power Connector
- LED Indicators
- PS/2 Keyboard and Mouse Connector
- USB1 & USB2: Universal Serial Bus connectors
- PCMCIA: PC Card Slot
- VGA: VGA Display Connector
- RESET: Reset Button

2.1 WebLink-2059 Peripherals

The following two figures show the connectors on WebLink-2059. The following sections give you detail information about function of each peripheral.

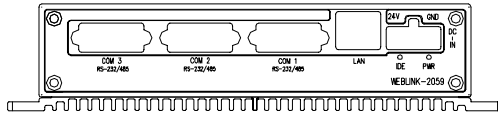

Figure 2-1: WebLink-2059 front panel

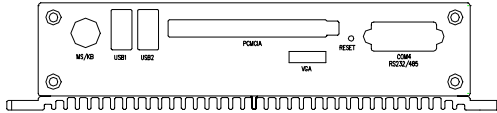

Figure 2-2: WebLink-2059 rear panel

2.2 COM1~COM4: RS-232/485 Interfaces

The WebLink-2059 offers four serial communication interface ports, and they are COM 1, COM 2, COM 3 and COM 4. Each port can be configured individually to either RS-232 or RS-485 using on-board jumpers (see Appendix A.2), and Table 2-1 lists the default setting of serial ports.

Table 2-1: Serial ports default setting

COM Port	Default Setting
COM1	RS-485
COM2	RS-485
COM3	RS-485
COM4	RS-232

16C954 UARTs with 128-byte standard

Advantech WebLink-2059 comes standard with Oxford OX16PCI964 UARTs containing 128 bytes FIFOs. These upgraded FIFOs greatly reduce CPU overhead and are an ideal choice for heavy multitasking environments.

Automatic Data Flow Control Function for RS-485

In RS-485 mode, WebLink-2059 automatically senses the direction of incoming data and switches its transmission direction accordingly. Therefore no handshaking signal (e.g. RTS signal) is necessary. This feature lets you simply and quickly build an RS-485 network with just two wires. More importantly, application software previously written for half duplex RS-232 environments can be maintained without need for modification.

IRQ and Address Setting

The IRQ and I/O address range are both assigned by BIOS, and four serial ports use the same IRQ.

2.3 LAN: Ethernet Connector

The WebLink-2059 is equipped with Realtek RTL8139C Ethernet LAN controller that is fully compliant with IEEE 802.3u 10/100Base-T CSMA/CD standards. The Ethernet port provides a standard RJ-45 jack on board, and LED indicators on the front side to show its Link (Yellow LED) and Active (Green LED) status.

2.4 Power Connector

The WebLink-2059 comes with a Phoenix connector that carries 10~30 V_{DC} external power input.

2.5 LED Indicators

There are two LEDs on the WebLink-2059 front panel for indicating system status: PWR LED is for power status and IDE LED is for internal CompactFlash™ card status.

2.6 PS/2 Keyboard and Mouse Connector

The WebLink-2059 provides a PS/2 keyboard and PS/2 mouse connector. A 6-pin mini-DIN connector is located on the rear panel of the WebLink-2059. The WebLink-2059 comes with an adapter to convert from the 6-pin mini-DIN connector to two 6-pin mini-DIN connectors for PS/2 keyboard and PS/2 mouse connection. Please refer to Appendix A.5 for its pin assignments.

2.7 USB1 & USB2: Universal Serial Bus connectors

The USB connector is used for connecting any device that conforms to the USB interface. Many recent digital devices conform to this standard. The USB interface supports Plug and Play, which enables you to connect or disconnect a device whenever you want without turning off the computer.

The WebLink-2059 provides two connectors of USB interfaces, which gives complete Plug & Play and hot swapping for up to 127 external devices. The USB interface complies with USB specification OpenHCI, Rev. 1.0. The USB interface can be disabled in the system BIOS setup. Please refer to Appendix A.6 for its pin assignments.

2.8 PCMCIA: PC Card Slot

The WebLink-2059 provides one PC Card slot that supports CardBus (Card-32) Card and 16-bit (PCMCIA 2.1/JEIDA 4.2) Card standard. It supports +3.3V, +5V and +12V@120mA working voltage.

PC Card is a 85.6 mm long by 54 mm wide (3.37" x 2.126") sized, 68-pin connector used and removable module standardized by PCMCIA that is known as "PCMCIA card."

2.9 VGA: VGA Display Connector

The WebLink-2059 provides a VGA controller for a high resolution VGA interface. It supports VGA and VESA, up to 1280 x 1024 @ 8 bpp and 1024 x 768 @ 16bpp resolution and up to 4 MB share memory. The VGA interface is reserved for system testing and debugging. The WebLink-2059's JP4 is a 6-pin mini connector for a VGA monitor. A VGA cable is attached to convert from a 6-pin mini connector to standard VGA connector. Pin assignments for VGA display are detailed in Appendix A.7.

2.10 RESET: Reset Button

Press "RESET" button will activate a reset function.

CHAPTER 3

Initial Setup

This chapter shows how to initial the WebLink-2059, sections include:

Sections include:

- Initial Procedure
- Insert CompactFlash Card
- Connect the power
- IP address configuration
- Wireless LAN IP address configuration
- BIOS Setup and System Assignments

3.1 Initial Procedure

The WebLink-2059 offers an easy setup feature: It takes three easy steps for your initial setup before use. Take out the WebLink-2059 from the package and follow the steps below for initial setup:

Step 1: For WebLink-2059/BAR product, insert your system CompactFlash memory card into the CompactFlash card slot inside the chassis.

Step2: Connector all peripheral devices, such as VGA display, keyboard, mouse, wireless LAN PCMCIA card and so on.

Step 3: Connect the power cord to the WebLink-2059 and plug the other end of the cord into the power outlet, and then WebLink-2059 boots up immediately.

Step 4: Assign static IP address to your WebLink-2059 and use Advantech Studio Development to design your application.

Step 5: Check BIOS setup and System Assignments if needed

Please refer to the Advantech Studio Quick Start Manual under “Manual” folder on CD-ROM for detailed information about the Advantech Studio software.

3.2 Insert CompactFlash Card (For WebLink-2059/BAR only)

The procedure for installing a CompactFlash™ card into the WebLink-2059/BAR is as follows, please follows these steps carefully.

Step 1: Remove power cord.

Step 2: Unscrew four screws from the rear panel of the WebLink-2059.

Step 3: Remove the rear panel.

Step 4: Plug a CompactFlash™ card with user’s OS and application program into a CompactFlash™ card slot on board.

Step 5: Screw back the rear panel with four screws.

3.3 Connect the power

Connect the WebLink-2059 to a $10 \sim 30 V_{DC}$ power source. The power source can either be from a power adapter or an in-house power source.

3.4 WebLink-2059 IP address configuration

Boot the WebLink-2059, and follow the steps as below:

Step 1: Click on the “**Start**” menu, “**Settings**”, “**Control Panel**”.

Step 2: Double click on the “**Network**” icon. In the “**Network Configuration**” window, click on “**Adapters**” tab, select the network driver “**RTL81391:...**” and click on “**Properties**” button.

Step 3: In the “**Realtek Ethernet Driver Settings**” window check the “**Specify an IP address**” and enter the appropriate settings for “**IP address**”, “**Subnet Mask**” and “**Default Gateway**”.

Step 4: Click on the “**Name Servers**” tab and enter the DNS settings.

Step 5: Click “**OK**” on the upper right corner of the window.

Step 6: Click “**OK**” on the “**Adapters**” window.

Step 7: Click “**OK**” on the “**Network Configuration**” window.

Step 8: Click on the “**Start**” button, “**Run...**” and type “**regsave**” in the “**Run**” window, click “**OK**”, and the “**Registry file is saved to the storage device successfully!**” window will pop up, click “**OK**”.

Step 9: Reboot the WebLink-2059.

Step 10: After reboot is completed. Open “**DOS prompt**” at WebLink-2059 and run “**ipconfig**” to verify if you got the right fixed IP.

3.5 Wireless LAN IP address configuration

Using Advantech WLAN-9030 Wireless LAN solution, please follow the steps as below:

- Step 1:** Click on the “**Start**” menu, “**Settings**”, “**Control Panel**”.
- Step 2:** Double click on the “**Network**” icon. In the “**Network Configuration**” window, click on “**Adapters**” tab, select the network driver “**WLAN1:...**” and click on “**Properties**” button.
- Step 3:** In the “**Realtek Ethernet Driver Settings**” window check the “**Specify an IP address**” and enter the appropriate settings for “**IP address**”, “**Subnet Mask**” and “**Default Gateway**”.
- Step 4:** Click on the “**Name Servers**” tab and enter the DNS settings.
- Step 5:** Click “**OK**” on the upper right corner of the window.
- Step 6:** Click “**OK**” on the “**Adapters**” window.
- Step 7:** Click “**OK**” on the “**Network Configuration**” window.
- Step 8:** Click on the “**Start**” button, “**Run...**” and type “**regsave**” in the “**Run**” window, click “**OK**”, and the “**Registry file is saved to the storage device successfully!**” window will pop up, click “**OK**”.
- Step 9:** Reboot the WebLink-2059.
- Step 10:** After reboot is complete, open “**DOS prompt**” at WebLink-2059 and run “**ipconfig**” to verify if you got the right fixed IP.

3.6 BIOS Setup and System Assignments

WebLink-2059 adopts Advantech SOM-2353 CPU module. For WebLink-2059 BIOS setup and system assignments, you can refer to SOM-2353 Chapter 4 “Award BIOS Setup” and Appendix A “System Assignments” for detailed information. The SOM-2353 user’s manual is located under “Manual” folder on the CD-ROM.”

Please note that you can try to “LOAD BIOS DEFAULTS” from BIOS Setup manual if the WebLink-2059 does not work properly.

APPENDIX A

Pin Assignments

This appendix gives the WebLink-2059 pin assignments

- Board Connectors and Jumpers
- RS-232/485 Serial Port
- Ethernet RJ-45 Connector
- Phoenix Power Connector
- PS/2 Keyboard and Mouse Connector
- USB Connector
- VGA Display Connector
- CompactFlash™ Master/Slave Jumper Setting

A.1 Board Connectors and Jumpers

There are connectors and jumpers on the WebLink-2059 board. The following sections tell you how to configure the WebLink-2059 hardware setting. Figure A-1 and figure A-2 show the locations of WebLink-2059 connectors and jumpers.

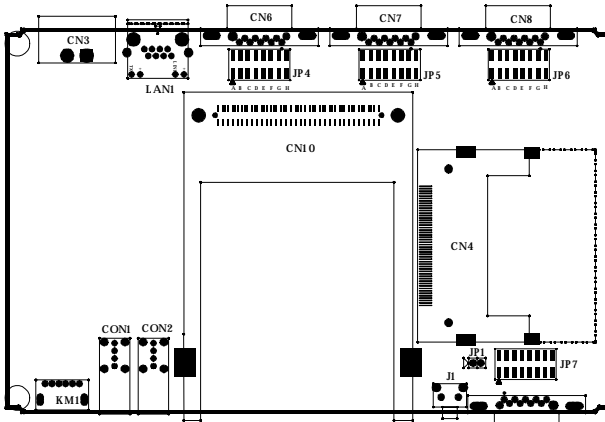

Figure A-1: WebLink-2059 connector and jumper locations (Top View)

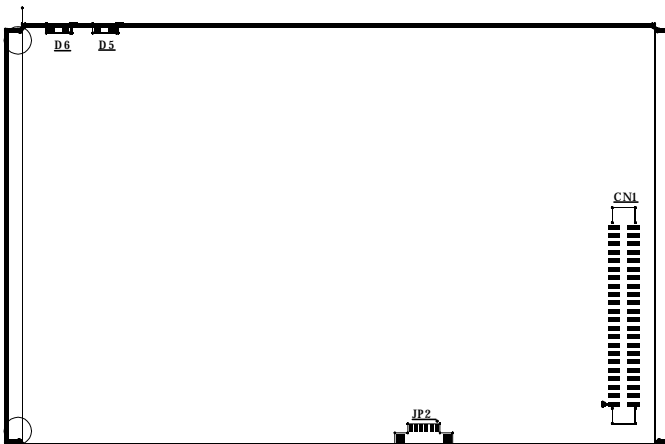

Figure A-2: WebLink-2059 connector and jumper locations (Bottom View)

Table A-1: WebLink-2059 connectors and jumpers

Label	Function
CN1	Internal IDE connector (reserved)
CN3	Phoenix power connector
CN4	Internal CompactFlash(tm) card slot
CN6	COM1 RS-232/485 serial port
CN7	COM2 RS-232/485 serial port
CN8	COM3 RS-232/485 serial port
CN9	COM4 RS-232/485 serial port
CN10	PC Card slot
CON1	USB1 connector
CON2	USB2 connector
D5	IDE LED
D6	Power LED
J1	Reset button
JP1	CompactFlash(tm) IDE Primary Master/Slave Jumper
JP2	VGA display connector
JP4	COM1 RS-232/485 selection
JP5	COM2 RS-232/485 selection
JP6	COM3 RS-232/485 selection
JP7	COM4 RS-232/485 selection
KM1	PS/2 Keyboard and Mouse connector
LAN1	Ethernet RJ-45 connector

A.2 RS-232/485 Serial Port (CN6~CN9)

Pin Assignments

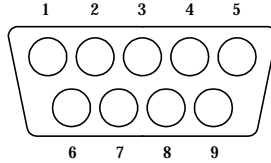

Table A-2: RS-232/485 serial port pin assignments

Pin	RS-232 Signal Name	RS-485 Signal Name
1	DCD	DATA-
2	RxD	DATA+
3	TxD	NC
4	DTR	NC
5	GND	GND
6	DSR	NC
7	RTS	NC
8	CTS	NC
9	RI	NC

Note: NC represents “No Connection.”

Terminator Resistors Setup for RS-485

The terminal resistors for impedance matching on the WebLink-2059 are not installed at the factory.

The user can install the resistors with the appropriate resistances according to the WebLink-2059 application. Each terminal resistor corresponds to a different channels for DATA+, DATA- lines. Usually, these resistors are needed for both ends of the communication wires and the value of the resistors should match the characteristic impedance of the wires used (approximately 120 Ohms or 300 Ohms). The TR1, TR2, TR3 and TR4 shown on Figure A-3 are prepared for COM1, COM2, COM4 and COM4 termination resistors respectively.

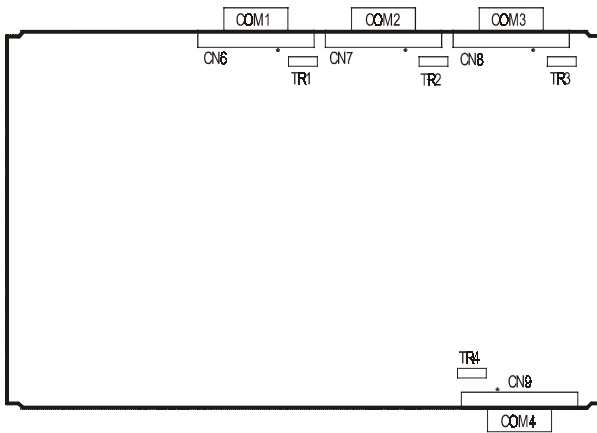

Figure A-3: COM ports terminator resistor locations

An example of the installation of COM1 is as follows:

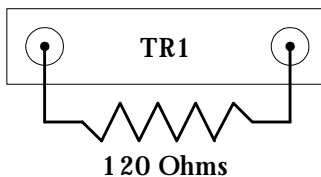

Figure A-4: Terminator resistor installation

RS-485 Signal Wiring

The RS-485 standard supports half-duplex communication. This means that just two wires are needed to both transmit and receive data. Handshaking signals (such as RTS, Request To Send) in RS-232 are normally used to control the direction of the data flow and to switch the transmission accordingly. In RS-485 mode, the WebLink-2059 automatically senses the direction of the data flow and switches the transmission direction - no handshaking is necessary. This means a user can build an RS-485 network with just two wires. This RS-485 control is completely transparent to the user. The software written for half duplex RS-232 works without the need for any modification.

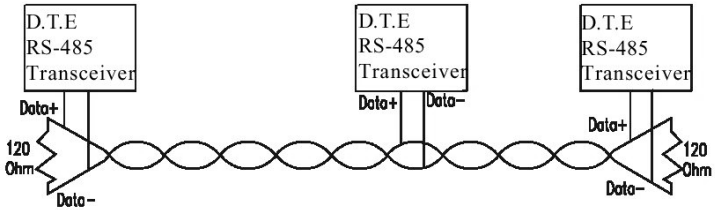

Figure A-5: RS-485 Wiring topology

RS-232/485 Selection

Four serial ports (COM1~COM4) all support RS-232 and RS-485 interfaces, and you can set corresponding jumpers to select serial ports as RS-232 or RS-485 interfaces shown in Table A-3.

Table A-3: Jumpers to select RS-232/485

Serial Port	Corresponding jumper to select RS-232/485
COM1	JP4
COM2	JP5
COM3	JP6
COM4	JP7

Jumper Setting for RS-232 Interface:

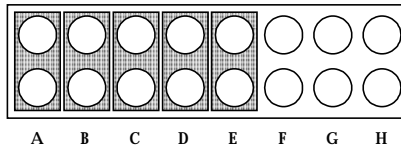

Figure A-6: RS-232 Jumper Setting

Jumper Setting for RS-485 Interface:

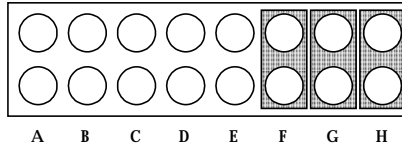

Figure A-7: RS-485 Jumper Setting

A.3 Ethernet RJ-45 Connector (LAN1)

Ethernet RJ-45 Connector Pin Assignments

Table A-4: Ethernet RJ-45 connector pin assignments

Pin	10/100Base-T Signal Name
1	XMT+
2	XMT-
3	RCV+
4	NC
5	NC
6	RCV-
7	NC
8	NC

A.4 Phoenix Power Connector (CN3)

Phoenix Power Connector Pin Assignments

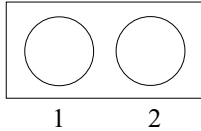

Table A-5: Phoenix power connector pin assignments

Pin	Signal Name
1	+10~30 V _{DC}
2	GND

A.5 PS/2 Keyboard and Mouse Connector (KM1)

PS/2 KB/MS Connector Pin Assignments

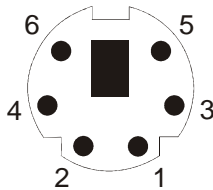

Table A-6: Keyboard and Mouse connector pin assignments

Pin	Signal Name
1	KB DATA
2	MS DATA
3	GND
4	VCC
5	KB CLOCK
6	MS CLOCK

A.6 USB Connector (CON1, CON2)

USB Connector Pin Assignments

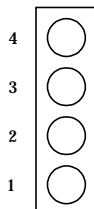

Table A-7: USB connector pin assignments

Pin	Signal Name	Cable Color
1	VCC	Red
2	DATA-	White
3	DATA+	Green
5	GND	Black

A.7 VGA Display Connector (JP2)

VGA Display Connector Pin Assignments

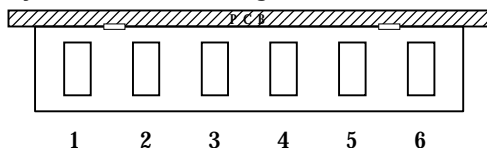

Table A-8: VGA display connector pin assignments

Pin	Signal Name
1	RED
2	H-SYNC
3	GREEN
4	V-SYNC
5	BLUE
6	GND

VGA Adaptor Cable Pin Assignments

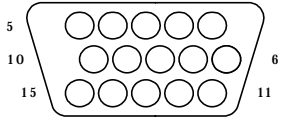

Table A-9: VGA adaptor cable pin assignments

Pin	Signal Name	Pin	Signal Name
1	RED	9	NC
2	GREEN	10	GND
3	BLUE	11	NC
4	NC	12	NC
5	GND	13	H-SYNC
6	GND	14	V-SYNC
7	GND	15	NC
8	GND		

Chipset

The Weblink-2059 uses a Cyrix CS5530A chipset for its SVGA controller. It supports interlaced and non-interlaced analog monitors (color and monochrome VGA) in high-resolution modes while maintaining complete IBM VGA compatibility. Digital monitors (i.e. MDA, CGA and EGA) are NOT supported. Multiple frequency (multisync) monitors are handled as if they were analog monitors.

Display memory

With 1 ~ 4 MB share memory, the VGA controller can drive CRT displays or color panel displays with resolutions up to 1024 x 768 at 64 K colors. For 1024 x 768 color resolution, the display is expanded to 4 MB in BIOS.

A.8 CompactFlash™ Master/Slave Jumper Setting (JP1)

The CompactFlash interface uses a primary IDE channel, which could be set as the master or slave device by changing the setting of JP1.

Master Device: (Default)

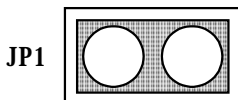

Slave Device:

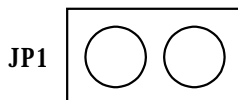

WebLink-2059 has one CompactFlash card slot in the chassis. It supports CompactFlash type I (3mm thick) and type II (5mm thick) cards

A 32 MB CompactFlash card is equipped in the WebLink 2059/CE and WebLink 2059/SDA. For WebLink-2059/BAR, there is no CompactFlash card on the slot. WebLink-2059 also supports IBM Microdrive storage device, which is an ultra-miniature hard disk from IBM that was introduced in 1998. The Microdrive is built into a Type II CompactFlash form factor.



Artisan Technology Group is your source for quality new and certified-used/pre-owned equipment

- FAST SHIPPING AND DELIVERY
- TENS OF THOUSANDS OF IN-STOCK ITEMS
- EQUIPMENT DEMOS
- HUNDREDS OF MANUFACTURERS SUPPORTED
- LEASING/MONTHLY RENTALS
- ITAR CERTIFIED SECURE ASSET SOLUTIONS

SERVICE CENTER REPAIRS

Experienced engineers and technicians on staff at our full-service, in-house repair center

*InstraView*SM REMOTE INSPECTION

Remotely inspect equipment before purchasing with our interactive website at www.instraview.com ↗

WE BUY USED EQUIPMENT

Sell your excess, underutilized, and idle used equipment. We also offer credit for buy-backs and trade-ins. www.artisanng.com/WeBuyEquipment ↗

LOOKING FOR MORE INFORMATION?

Visit us on the web at www.artisanng.com ↗ for more information on price quotations, drivers, technical specifications, manuals, and documentation

Contact us: (888) 88-SOURCE | sales@artisanng.com | www.artisanng.com