



Artisan Technology Group is your source for quality new and certified-used/pre-owned equipment

- FAST SHIPPING AND DELIVERY
- TENS OF THOUSANDS OF IN-STOCK ITEMS
- EQUIPMENT DEMOS
- HUNDREDS OF MANUFACTURERS SUPPORTED
- LEASING/MONTHLY RENTALS
- ITAR CERTIFIED SECURE ASSET SOLUTIONS

SERVICE CENTER REPAIRS

Experienced engineers and technicians on staff at our full-service, in-house repair center

*InstraView*SM REMOTE INSPECTION

Remotely inspect equipment before purchasing with our interactive website at www.instraview.com ↗

WE BUY USED EQUIPMENT

Sell your excess, underutilized, and idle used equipment. We also offer credit for buy-backs and trade-ins. www.artisanng.com/WeBuyEquipment ↗

LOOKING FOR MORE INFORMATION?

Visit us on the web at www.artisanng.com ↗ for more information on price quotations, drivers, technical specifications, manuals, and documentation

Contact us: (888) 88-SOURCE | sales@artisanng.com | www.artisanng.com

**Agilent Technologies N1610A
Service Advisor Portable Test Tablet**

User's Manual

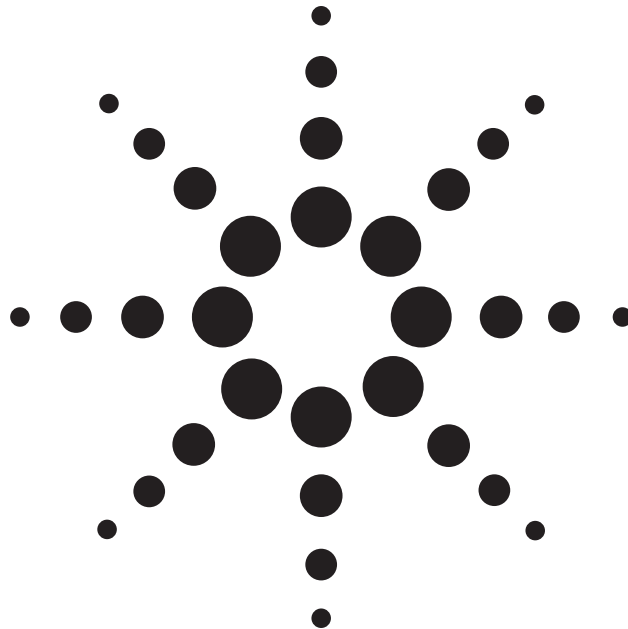

Agilent Technologies

Copyright © 2000
Agilent Technologies, Inc.

All rights reserved.
Reproduction, adaptation, or
translation without prior
written permission is
prohibited, except as allowed
under the copyright laws.

Publication part number:
N1610-90000

Version 4.0
June, 2000

Printed in USA.

Warranty

The information contained in
this document is subject to
change without notice.

**Agilent Technologies makes
no warranty of any kind
with regard to this material,
including, but not limited to,
the implied warranties of
merchantability and fitness
for a particular purpose.**

Agilent Technologies shall not
be liable for errors contained
herein or for incidental or
consequential damage in
connection with the furnishing,
performance, or use of this
material.

Warning!

Changes or modifications to
this unit not expressly
approved by the party
responsible for compliance
could void the user's authority
to operate the equipment.

Trademark Credits

Windows[®] and MS-DOS[®] are
U.S. registered trademarks of
Microsoft Corporation.

All other trademarks are the
property of their respective
owners.

ISO Certification

Agilent Technologies' Service
Test Division (STD) is an
International Standards
Organization (ISO) 9001
registered company,
recognizing that the quality
system operated by STD meets
the requirements established in
accordance with ISO 9001.
STD manufactures test
equipment in strict compliance
with this quality system.

STD received ISO 9001
certification (no. 6969) from
National Quality Assurance
(NQA) on August 30, 1995.



Certificate No. 6969

Agilent Technologies
Service Test Division
2 Robbins Road
Westford, Massachusetts 01886 USA

Safety Notices

Observe the following safety precautions whenever you operate the Service Advisor Tablet. Failure to comply with these and other specific warnings and cautions in this manual is a violation of Agilent Technologies' safety standards of design, manufacturing, and intended use of the test module.

Agilent Technologies assumes no liability for the operator's failure to comply with these precautions.

Product Damage

Danger! Do not use this product if it shows visible damage, fails to perform, has been stored in unfavorable conditions, or has been subject to severe transportation stresses. Make the product inoperative and secure it against any unintended operation. Contact your Agilent Technologies representative for assistance.

Explosion Hazard

Danger! Do not operate the instrument in the presence of flammable gases or fumes.

Electric Shock Hazard

Danger! To avoid the possibility of severe injury or death, observe the following precautions when using the Service Advisor Tablet.

Do not remove the system covers, and do not perform electrical tests if there are signs of shipping damage to the outer enclosure.

When connecting test cables to a line, do not touch the cable's metal contact points, or allow the cable leads to touch each other.

Use only the supplied power cords and connect only to a properly grounded wall outlet. Do not use extension cords that do not have a protective ground conductor.

Symbols

The following are general definitions of safety symbols used on equipment and in manuals.

Dangerous voltage.



Protective ground.



Frame or chassis ground.



Alternating current.



Direct current.



Alternating or direct current.



Caution! Read the manual.



About this Book

Getting Started

Chapter 1 *Getting Started* introduces the Service Advisor Portable Tablet N1610A, (hereafter called the *Tablet*) and illustrates its features and controls.

Chapter 2 *Using the Service Advisor Tablet* describes how to perform basic functions with the Tablet, such as connecting power, installing modules and PC cards, downloading, starting, and stopping software, and working with the Service Advisor Manager software.

Using the IP Service Advisor Software

Chapter 3 *IP Service Advisor Software*, and Chapter 4 *Testing with the IP Service Advisor*, describe how to perform tests using the IP Service Advisor.

Chapter 5 *IP Service Advisor Reference* contains reference information. This material describes the function of each of the controls and indicators in the IP Service Advisor display screens.

Using the SACompanion Software

Chapter 6 *Using the SACompanion Software* explains how to install and use the SACompanion software to upgrade the Tablet's system or module software, to remotely set up and control a test module installed in the Tablet, and perform file management functions for files residing in the Tablet.

SCPI Reference

Chapter 7 *Remote Operation* contains reference information for using SCPI commands to operate the Tablet remotely.

Specifications

Chapter 8 *Specifications* lists technical specifications of the Tablet, along with information about how to order accessories.

About this Version

Applicability

This version of the *Agilent Technologies N1610A Service Advisor Portable Test Tablet User's Manual* applies to the N1610A Service Advisor Tablet running operating system software version **1.30**.

Note that some systems running earlier software may not provide all of the features described in this manual; systems running later versions of software may operate differently than described in this manual. Be sure to refer to any user's manual supplements or release notes that came with the unit, or call 1-800-923-7522.

Service Advisor Tablet User's Manual printing history

| Version | Release date | Notes |
|---------|-----------------|---|
| 1.0 | March, 1999 | |
| 2.0 | September, 1999 | |
| 3.0 | November, 1999 | |
| 4.0 | June, 2000 | Software Release 1.3 lets you connect your Tablet to an Ethernet network and upgrade any modules that may be installed in a networked Tablet. |

Check the Software Version

You can check the software version number by pressing the **Help** button on the tablet control screens, or by checking the **Tablet Control** tab of the Service Advisor Manager.

Contents

Declaration of Conformity iv

About this Book v

About this Version vi

1

Getting Started 1-1

The Service Advisor Tablet (N1610A) at a Glance 1-2

Tablet Controls 1-3

Module Bays and Slots 1-4

Connectors 1-5

The Touch-Sensitive Screen Display 1-6

Application Programs 1-8

2

Using the Service Advisor Tablet 2-1

Connecting Power 2-2

Battery Operation 2-3

Installing Modules 2-6

Working with PC Cards 2-7

Starting and Stopping Tablet Software 2-8

Working with the Service Advisor Manager 2-10

Setting the Tablet Configuration 2-16

Communication Port Setup 2-17

Power Configuration 2-18

Local/Remote Setup 2-19

Setting the Date and Time 2-20

Setting Up Network Properties 2-21

Adjusting Tablet Properties 2-23

3

IP Service Advisor Software 3-1

Connecting to the Network and Starting the IP Service Advisor 3-2

The IP Service Advisor User Interface 3-3

Configuring IP Service Advisor Defaults 3-7

| | | |
|----------|--|------------|
| 4 | Testing with the IP Service Advisor | 4-1 |
| | Issuing a PING | 4-2 |
| | Performing a Trace-Route | 4-4 |
| | Performing a DNS Lookup | 4-6 |
| 5 | IP Service Advisor Reference | 5-1 |
| | The Ping Screen | 5-2 |
| | The Trace-Route Screen | 5-5 |
| | The DNS Screen | 5-8 |
| | The Setup Defaults Screen | 5-9 |
| 6 | Using the SACompanion Software | 6-1 |
| | SACompanion at a Glance | 6-2 |
| | Connect a Companion PC to a Tablet | 6-3 |
| | Using an HP OmniBook 800 | 6-4 |
| | Installing SACompanion | 6-7 |
| | Start the SACompanion Program | 6-12 |
| | Set the Communications Settings | 6-14 |
| | Configuring the Ethernet Interface | 6-16 |
| | Upgrade System or Module Software | 6-19 |
| | Check Software Revision Levels | 6-19 |
| | Upgrade Service Advisor Software | 6-22 |
| | Upgrade Module Software | 6-24 |
| | Remotely Launching a Module | 6-25 |
| | Remotely Powering On an Installed Module | 6-26 |
| | Close the Module's Software | 6-27 |
| | Remove a Module From a Tablet | 6-28 |
| | Copy Files to and From the Flash PC Card | 6-29 |
| | Deleting Files | 6-32 |
| | SCPI Tools | 6-33 |
| | Exit the SACompanion Application | 6-34 |

7

Remote Operation 7-1

- Remote Operation Using SCPI Commands 7-2
- SCPI Command Syntax 7-3
- Setting Up a Connection for SCPI Operation 7-6
- Common SCPI Tablet Commands 7-7
- SCPI Return Codes 7-8
- SYSTEM Commands 7-9
- Serial Communication Commands 7-11
- SOURCE Commands 7-13
- FETCH Commands 7-14

8

Specifications 8-1

- Service Advisor Tablet (N1610A) Specifications 8-2
- Ordering Information 8-3
- CLEI Codes 8-4

Warranty, Calibration, and Service

Glossary

Index

Contents

1

The Service Advisor Tablet (N1610A) at a Glance 1-2

Tablet Controls 1-3

Module Bays and Slots 1-4

Connectors 1-5

The Touch-Sensitive Screen Display 1-6

Application Programs 1-8

Getting Started

1-1

The Service Advisor Tablet (N1610A) at a Glance

Front Panel

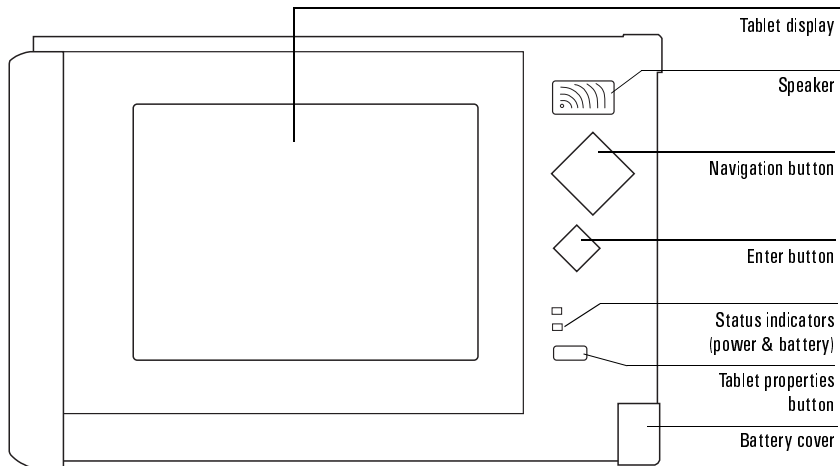

Top

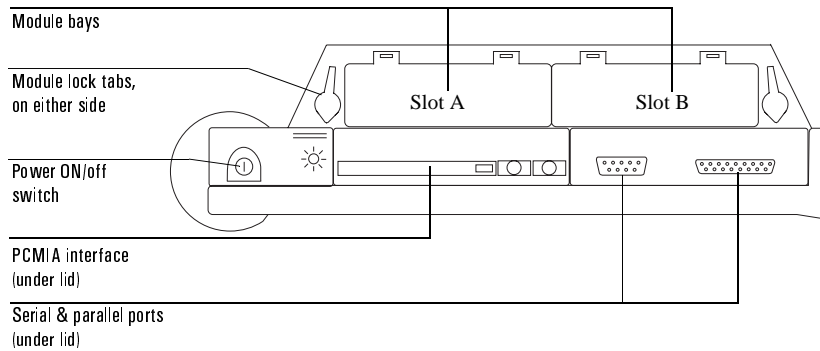

Tablet Controls

This section describes the Tablet's controls.

Power ON/Off Switch

The power switch (on the top of the unit) controls power to the Tablet. It may be necessary to lift the lid to access the power switch underneath.

ON: Switches on power to the Tablet, either from a connected power source or from the internal battery.

OFF: Switches off power to the Tablet.

Front-Panel Buttons

Three front-panel buttons control the user interface and the display.

Navigation button: Pressing a corner of this button moves the cursor in that direction (up, down, left, or right).

ENTER button: Pressing this button executes the selected function in the user interface.

Tablet properties button: Pressing this button displays a popup screen for setting properties, such as speaker volume, screen contrast, and backlight options. The popup screen also provides information about the battery charge, and contains options for calibrating the touch screen. (See *Adjusting Tablet Properties*, page 2-23, for more information.)

You also press this button as part of the download process. See *Upgrade Service Advisor Software*, page 6-22.

Front-Panel Indicators

Several front-panel indicators provide information about the Tablet operating status.

Power: This LED lights to show that the Tablet is switched ON and power is present.

Battery Status: This LED lights to indicate battery activity, and remains lit while the battery is being recharged.

Module Bays and Slots

The following figure shows the bays and slots on the top of the Tablet.

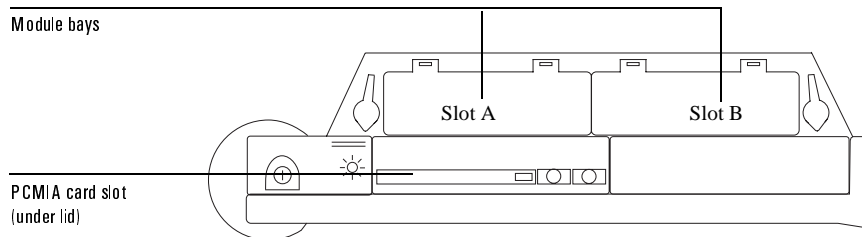

Module bays: Accepts either a single dual-size test module, or two single-size modules (a test module and a line interface module).

PCMIA card slot: Accepts PCMIA cards, such as the LAN or modem NICs and flash-ROM cards. You can use a LAN or modem NIC to control the Tablet from a remote PC. A flash-ROM card enables you to load and store programs and data.

Connectors

On the top of the Tablet are several sets of connectors and ports for connecting to external devices, such as printers and remote PCs.

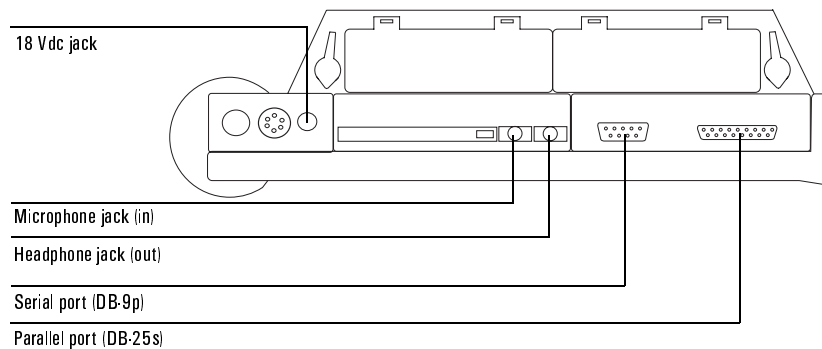

18 Vdc jack: Input jack for an external power source, such as the N1612A Vac power adapter or the N1614A 12 Vdc vehicle power adapter.

Microphone jack: (Input jack) *In the future*, this jack will be available to accept voice input for plug-in modules (for example, a SONET orderwire or DS0 voice channel).

Headphone jack: (Output jack for 32-Ohm device) Allows you to connect a headphone or earphones and listen to sounds such as Tablet key clicks, and plug-in module sounds like TIMS tones and dialing.

When the headphone jack is in use, speaker sound is shut off.

Serial port: (DB-9 pin) For serial connections to another device, such as a PC.

Parallel port: (DB-25 socket) For connecting to a printer.

The Touch-Sensitive Screen Display

The Tablet's touch-screen display and graphical user interface (GUI) provide easy access to the test and measurement functions on the installed plug-in module (for example, TIMS or ATM/SONET). The GUI software is included in the plug-in module software.

The major components of a typical GUI display (a Dual DS1/0 GUI) are shown below. The GUI screens of other plug-in modules are similar.

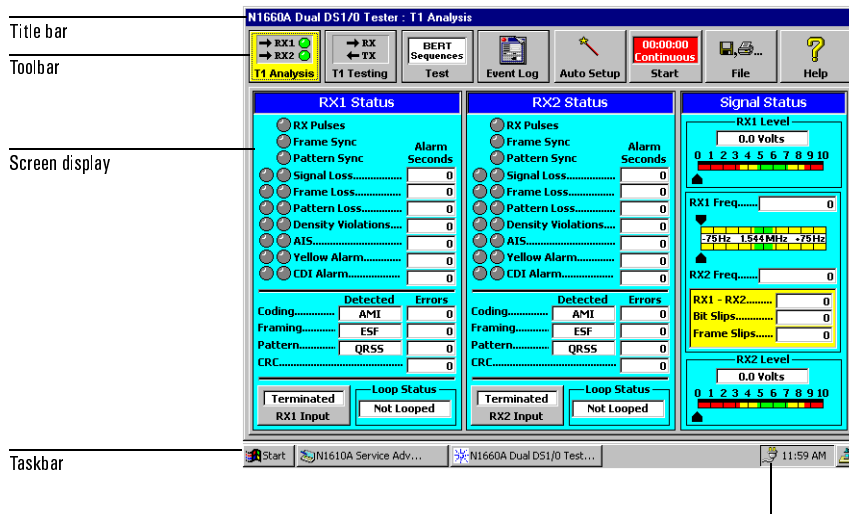

Tablet toolbar showing keyboard icon, power source, and the current time

Major Screen Components

Title Bar: Displays the title of the current screen.

Toolbar: Contains popup menus for task selection and file management tasks.

Screen display: Contains controls for task selection and for configuring test parameters. Test screens display test setup parameters and test results.

Taskbar: Provides access to the Windows® Start menu, and any software running on the Tablet (for example, the GUI for the installed plug-in module and the Service Advisor Manager).

Tablet Toolbar: Includes icons used to call the tablet's touch-sensitive keyboard, a battery life indicator, or a date and time setup display.

Navigation Basics

Following is a list of basic steps for navigating a GUI. See the user's manual for your plug-in module for more information.

- Select options and buttons by simply touching them on the screen. Use your finger or use the stylus that came with the Tablet. (The stylus is stored in the back of the module bay.)
- Select **OK** to perform a particular task. **Cancel** closes the current window without doing anything.
- When you select an option that requires a numeric value, the GUI displays a popup keypad containing a list of values and/or options. Select the appropriate value in the popup.

Tap the **OK** button to write the value to the selected field (the popup box closes automatically). Use the **Clear** button to clear a parameter field before entering a new value. Use the **Save** or **OK** buttons to enter a new value, or the **Cancel** button to close the popup box without changing the value.

- Select the **N1610A Service Advisor** taskbar option to quit a module GUI. Select the module's taskbar option to move from the Service Advisor screens to the test module GUI.

Note: When a test module is inserted into the Tablet, the tablet display defaults to the main test module GUI upon power turnon.

Application Programs

The *Tablet* comes equipped with a Windows® CE operating system and a number of Windows application programs. An applications specific program, called IP Service Advisor, is also included.

The IP Service Advisor Software (N1604A)

The *Tablet* and IP Service Advisor software (N1604A) provide a portable test and measurement system for IP-related services. This software is used for installing and qualifying Internet Service Provider (ISP) related services.

2

| | |
|--|------|
| Connecting Power | 2-2 |
| Battery Operation | 2-3 |
| Installing Modules | 2-6 |
| Working with PC Cards | 2-7 |
| Starting and Stopping Tablet Software | 2-8 |
| Working with the Service Advisor Manager | 2-10 |
| Setting the Tablet Configuration | 2-16 |
| Communication Port Setup | 2-17 |
| Power Configuration | 2-18 |
| Local/Remote Setup | 2-19 |
| Setting the Date and Time | 2-20 |
| Setting Up Network Properties | 2-21 |
| Adjusting Tablet Properties | 2-23 |

Using the Service Advisor Tablet

Connecting Power

Connecting Power

You can operate the Tablet using power from an external Vac power source, or from the 12 Vdc battery of your vehicle. The Tablet also has an internal battery for field operation.

Connecting AC Power

Follow these steps to power the unit from an external Vac power source.

1. Use the correct ac power cord (see page 8-3 for a listing) to connect the N1612A ac power adapter to a grounded Vac power outlet. The adapter's green LED lights up to show that power is present.
2. Connect the adapter's 18 Vdc lead to the Tablet's 18 Vdc input jack.
3. To switch ON the Tablet, press the power switch on the top of the unit. (You may have to lift the lid to access the power switch below.) The power LED on the front panel lights up to show that the unit is ON and power is present.

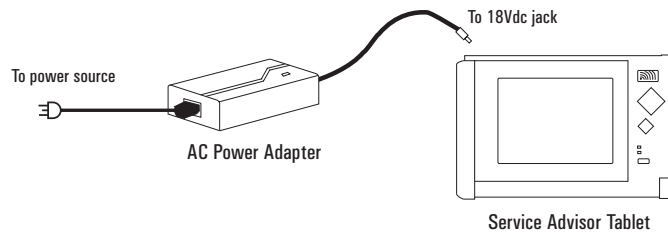

Connecting DC Power

Follow these steps to power the Tablet from a 12 Vdc vehicle power source.

1. Connect the 18 Vdc lead of the 12 Vdc vehicle power adapter (N1614A) to the 18 Vdc input jack on the top of the Tablet.
2. Plug the other lead into a 12 Vdc power outlet in your vehicle (often the cigarette lighter outlet).
3. Press the Tablet's power switch ON. (It may be necessary to lift the lid to access the power button below.) The power LED on the front panel lights up to show that the unit is ON and power is present.

Battery Operation

The Tablet is equipped with an NiMH rechargeable battery that provides between 2.5 to 3.5 hours of operation, depending on the plug-in modules installed. You can use the N1613A external battery recharger to recharge the battery outside the Tablet, or you can connect the unit to an external power source and allow the tablet's internal battery charger to recharge the battery (even if the unit is off).

Note: The front-panel battery status LED lights up when approximately 10 minutes of battery power remains.

Battery Installation

To install the rechargeable battery into the Tablet:

1. Locate the battery compartment cover on the lower right side of the Tablet.
2. Slide the battery cover down and off to reveal the battery.
3. Grasp the battery by its pull tab and slide it straight into the battery compartment.
4. Reinstall the battery compartment cover.

Battery Removal

To remove the battery:

1. Locate the battery compartment cover on the lower right side of the Tablet front panel.
2. Slide the battery cover down and off to reveal the battery.
3. Grasp the battery by its pull tab and pull it straight out of the battery compartment.
4. Reinstall the battery compartment cover to keep out dust while the battery is missing.

Note: When shipping the Tablet, it is recommended that the battery be removed and packaged separately.

Battery Operation

Checking the Battery Charge

1. Locate the battery compartment cover on the lower right side of the Tablet front panel.
2. Slide the battery cover down and off to reveal the battery.
3. Grasp the battery by its pull tab and pull it straight out of the battery compartment.
4. Tap the battery charge-indicator button to display the current battery charge. If the battery needs to be recharged, see the following sections.
5. Reinstall the battery by pushing it into the battery compartment until it seats firmly. Then, reinstall the battery compartment cover.

Recharging the Battery

Follow these steps to recharge the battery while it is installed in the Tablet. When external power is present, the tablet's battery recharges even when the unit is off.

1. Connect the Tablet's power adapter to a power source:
 - Connect the ac Power Adapter (N1612A) to a grounded 115Vac power outlet. The adapter's green LED lights up.
 - Connect 12 Vdc Vehicle Power Adapter (N1614A) to a 12 Vdc power outlet in your vehicle (often the cigarette lighter outlet).
2. Connect the power adapter's 18 Vdc lead to the 18 Vdc jack on the top of the Tablet. The battery charge LED on the front panel lights up to show that the battery is recharging.

Using the External Battery Recharger

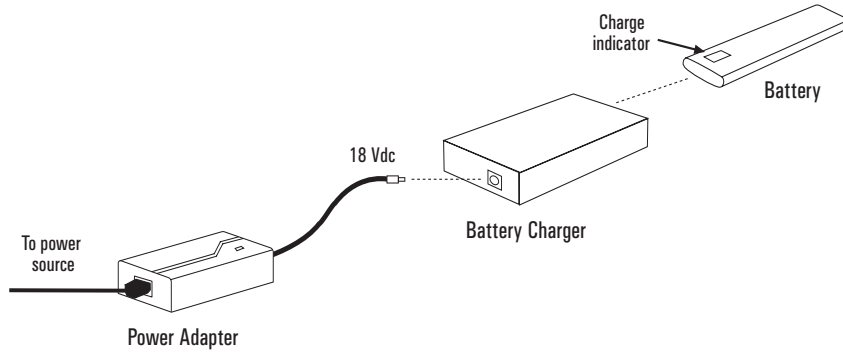

To recharge a battery outside the Tablet, follow these steps.

1. Insert the battery in the external battery charger (N1613A).



2. Connect the battery charger to one of the power adapters (N1612A or N1614A) using the adapter's 18 Vdc lead.
3. Connect the power adapter to a power source (see *Connecting AC Power*, or *Connecting DC Power*, page 2-2).
4. Observe the LEDs on the battery charger and battery to determine the state of the battery charge.

N1613A Battery Charger LEDs

| LED | State | Meaning |
|---|----------------|--|
|  | Flashing green | Battery establishing connection to charger |
| | Green | Battery fully charged |
| | Amber | Battery recharging |
| | Off | No battery present |
|  | ON | External power present |
| | Off | No external power present |

Installing Modules

Installing Modules

The Tablet accepts either a dual-size module (like xDSL TMS), or two single-size modules (like ATM Cell Processor and SONET/SDH).

Note: You can install modules when the Tablet is ON or off.

1. Locate the module bays at the top of the unit.

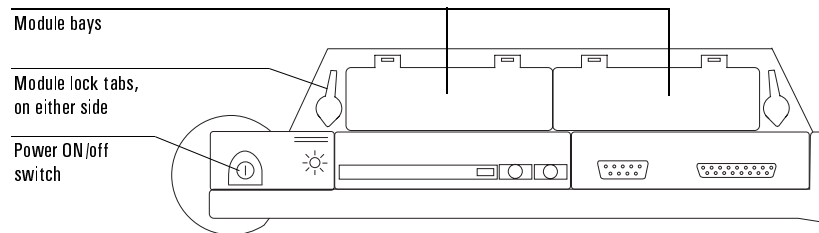

2. Lift the module bay cover(s), and align the test module with the bay. The module's label should face the front of the unit.
3. Slide the module all the way into the bay until it seats firmly with the connector in the bay.
4. Lock the module locking tab to secure the module in the bay.
5. The module's READY indicator lights up when the module is ready for operation.

Working with PC Cards

This section provides information about working with PCMCIA cards, such as network interface cards (NICs). The Tablet accepts LAN and modem NICs (such as the N1618A and N1620A) for connecting to the unit remotely, and flash-ROM cards (such as the N1621A) for loading and storing data.

To install PC cards in the Tablet, follow these steps:

1. Lift the lid of the PC card slot on the top of the unit.

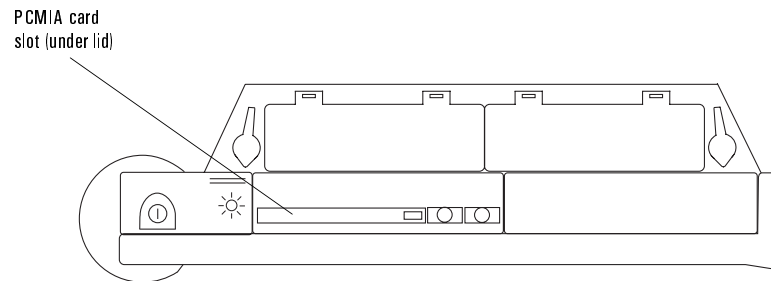

2. Align the PC card with the card slot, and push the card into the slot until it seats firmly with the connector.
3. For LAN and modem NICs, install the appropriate cable to connect the NIC to the LAN outlet or to the modem jack.
 - Install an Ethernet RJ-45 to RJ-45 cable to connect the LAN card to a 10-BaseT network outlet.
 - Install an RJ-11 to RJ-11 serial cable to connect the PC card to a modem.

Starting and Stopping Tablet Software

This section describes how to switch ON the Tablet and start the software. It also provides information about startup operation.

Starting the GUI

Press ON the power switch on the top of the Tablet. You may have to lift the lid to access the power switch underneath.

Note: If you are using battery power and there isn't enough power to run the Tablet and installed module(s), a warning message is displayed. If this occurs, recharge the battery or connect the Tablet to an external power source.

- By default, the Tablet launches the Service Advisor Manager software. When the tablet's autostart feature is enabled, the Service Advisor Manager then activates the graphical user interface (GUI) for the installed module. See *AutoStart Module*, page 2-16, for information on reconfiguring Tablet startup settings.
- If no module is installed, the main Service Advisor Manager screen appears when you switch ON the Tablet (see page 2-10). After installing a module, you can use the **Enable** option to activate the GUI (see *Enable*, page 2-11).

Start Taskbar

You can use the Windows **Start** button, in the bottom left-hand corner of the screen, to access applications programs such as the Windows Explorer, the Internet Explorer, or the tablet control panel (via the settings option). You can access these options directly from any window, simply select the applications program in the **Start** button's popup taskbar.

- To exit the Windows CE desktop, select **Suspend** from the Windows CE Start menu. This turns off the tablet display. When the tablet is in suspend mode, you can touch the screen to reactivate the display.

Stopping Tablet Software

Stop the Tablet software and switch off the unit, as follows:

- Select the **Shutdown** button in the Service Advisor Manager, and answer **yes** when prompted to shutdown. (You can access the Manager by clicking its icon in the taskbar.)

The Tablet stops any active tests, closes the GUI, and then shuts down the Service Advisor Manager. By default, power is also switched off. To configure the Tablet to leave power ON when you shutdown, see *Power Configurations*, page 2-16.

Note: You can also shut down the GUI and Service Advisor Manager software by pressing the power switch off; however, Agilent recommends you use the shutdown option.

Working with the Service Advisor Manager

The *Service Advisor Manager* software runs on the Tablet. It displays information about the tablet's current configuration and provides controls for configuring the tablet. The Service Advisor Manager is invoked at startup, and continues to run until you shut it down.

You can access the Service Advisor Manager from the GUI at any time by selecting its icon in the taskbar at the bottom of the screen. To minimize the Service Advisor Manager screen to an icon, click its icon-holder in the taskbar.

The Tablet Control Screen

The main Service Advisor Manager screen (shown here) provides information about current Tablet configuration settings.

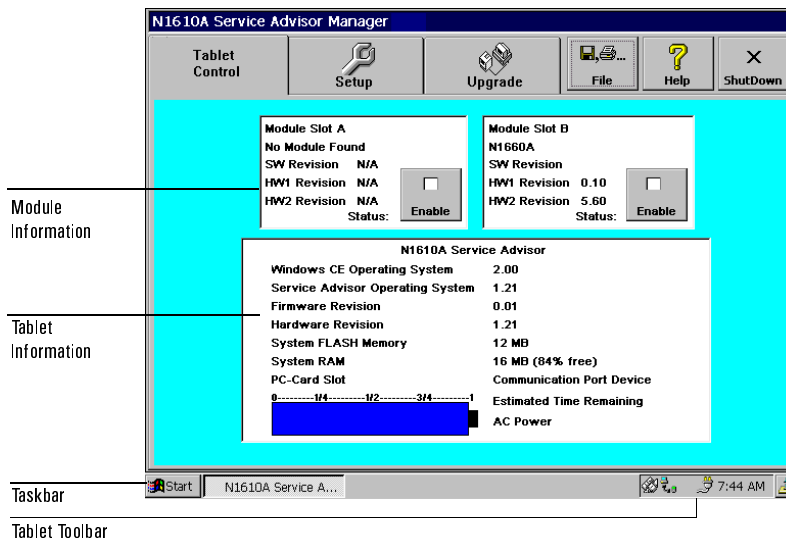

Module Information

The top half of the screen presents information about any modules installed in the Tablet.

Module Name: The type of module installed in the module slot.

SW Revision: The module's software revision.

HW1 & HW2 Revision: The hardware revision of the main (HW1) and secondary (HW2) circuit cards in the module.

Enable: Checking this button activates the GUI for the installed module.

Tablet Information

The lower half of the screen presents information about the Tablet.

Windows CE Operating System: The version number of the Windows CE operating system software running on the Tablet.

Service Advisor Operating System: The version number of the Service Advisor Manager software.

Hardware Revision: The Tablet's hardware revision number.

Firmware Revision: The version number of the Service Advisor Manager firmware.

System FLASH Memory: The amount of flash memory available in the Tablet.

System RAM: The amount of random-access memory available on the Tablet, and the percentage free (%).

PC-Card Slot: The type of PC card installed in the Tablet.

The **battery** diagram shows the current battery charge, and projected length of time the battery can power the Tablet and installed modules.

Toolbar

The toolbar contains options for performing other functions.



Tablet Control: Displays Tablet configuration information (see page 2-10).

Setup: Is used to configure basic operating characteristics (see page 2-16).

Upgrade: Is used for activating options that you purchase with your Tablet (see the activation procedure shipped with the option).

File: Presents file-management options, such as Print, Run, and Shutdown (see below).

Help: Displays the current version number of the Service Advisor Manager software.

Shutdown: Exits the Service Advisor Manager software, and switches off the Tablet.

If you uncheck **Power Off on ShutDown** (under the Setup tab's Power Configuration option, see page 2-16) power remains ON and the Windows CE desktop is displayed.

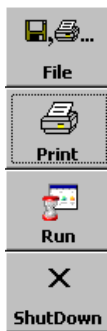

File Popup Menu

The File button calls a popup menu which presents the following options.

Print: Calls a print manager display.

Run: Calls a display offering three service management options: IP Service Advisor, Internet Explorer, and Windows Explorer.

Shutdown: Exits the Service Advisor Manager software, and switches off the Tablet.

Print Manager

Use the Print Manager control screen to print files from the tablet's database, from the PCIA Card, or from a test module in one of the tablet's two module bays.

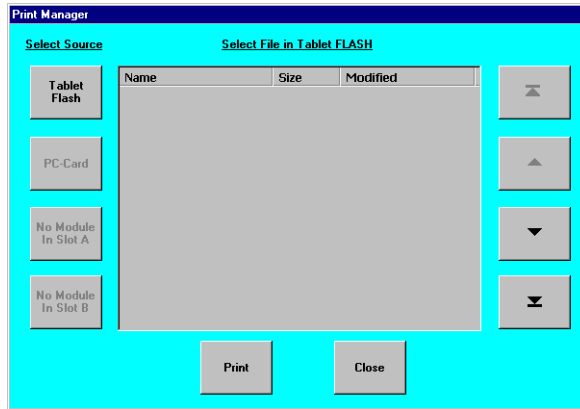

One of the four **Select Source** buttons must be selected to identify the location of the data file or files to be printed. The up and down arrow keys are used to scroll up and down in the selected list of files. Use the up and down arrow keys with bars to jump to the beginning or end of the list. Use the **Print** button to print the selected file, or the **Close** button to return the Service Advisor screen.

Run

The Run menu offers three applications programs.

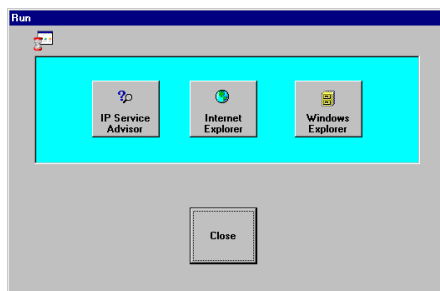

Using the Service Advisor Tablet

IP Service Advisor

Tapping the IP Service Advisor button calls the Ping screen, the first screen in the IP Service Advisor software (N1604A). This software provides a portable test and measurement system for IP-related services. This software is used for installing and qualifying Internet Service Provider (ISP) related services.

Using the IP Service Advisor software, you can:

- “ping” network nodes to determine their accessibility
- look up host names and IP addresses
- determine the hops to a particular network node

The IP Service Advisor allows connections through any 10Base-T network jack.

Internet Explorer

Tapping the Internet Explorer button calls up Microsoft’s Internet browser software, version 2.0. You can use this software for file management functions. Refer to Microsoft Windows CE documentation for details on its use.

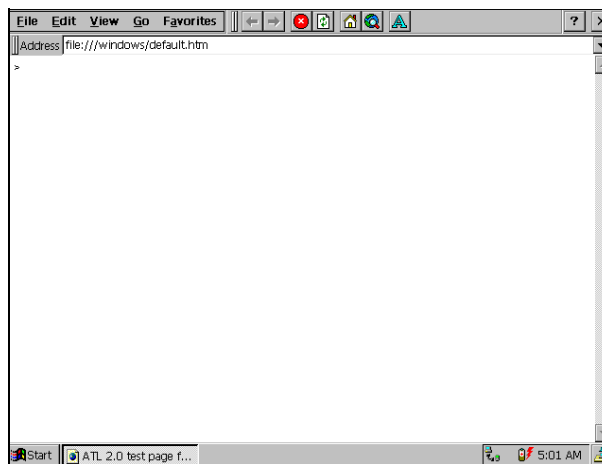

Windows Explorer

Tapping the Windows Explorer button calls up Microsoft's Windows Explorer[®] software, version 2.0. You can use this software for file management functions. Refer to Microsoft Windows CE documentation for details on its use.

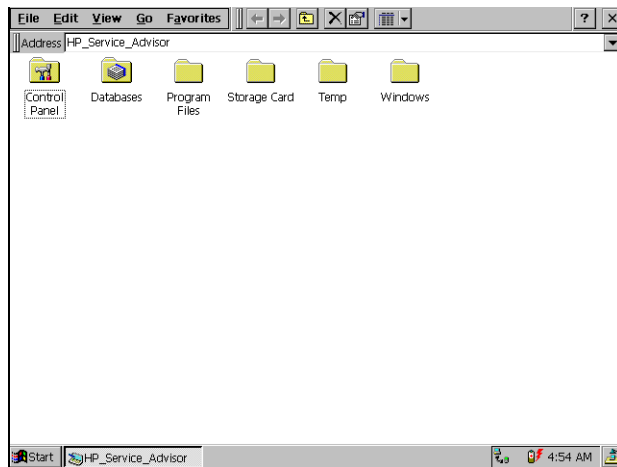

Setting the Tablet Configuration

The **Setup** tab contains controls for changing the tablet's configuration options.

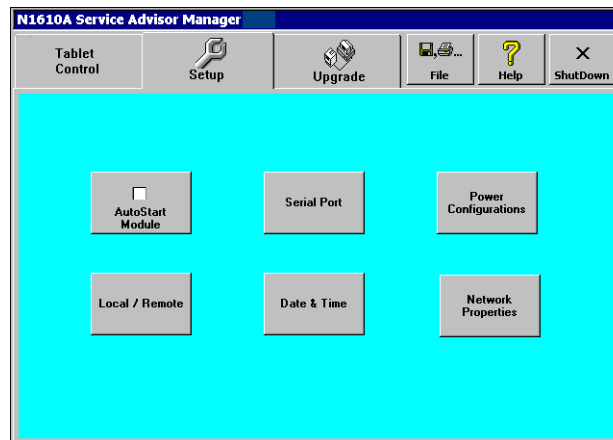

Note: Configuration settings are saved for future sessions. Just be sure to use **Shutdown** to exit the Tablet.

AutoStart Module: When enabled, this button starts the test module's GUI when you switch ON the Tablet or insert a plug-in module.

When unchecked, the Service Advisor Manager is displayed at startup. You can activate the test module's GUI by tapping the **Enable** button on Service Advisor Manager screen.

Serial Port: Calls a popup display with controls for configuring the communications settings for the Tablet's serial port. The display parameters include baud rate, the number of data and stop bits, and type of parity (see page 2-17).

Power Configurations: Calls a popup display used to configure the power-off settings for the Tablet and modules (see page 2-18).

Local/Remote: Calls a setup tab used to configure the Tablet for local or remote operation (see page 2-19).

Date & Time: Calls a popup display showing the current date and time. The time and date values can be changed if they are not correct (see page 2-20).

Network Properties: Calls a Network Setup screen, which is used to enter the network protocol and address information needed to support Internet communication (see page 2-21).

Communication Port Setup

When you connect the Tablet to a PC using the Serial port, or to an Ethernet network using the Ethernet LAN PC card (N1620A), you must set the proper communications settings on the Serial Port Setup screen. The Tablet's default settings are *115,200 baud, 8 data/1 stop bit, no parity*.

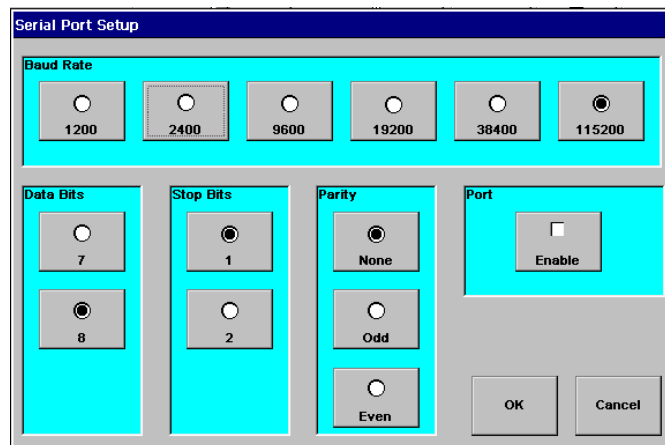

Baud Rate: Select a baud rate for the serial or Ethernet interface.

Data Bits: Select either seven bit (ASCII) or eight bits data word.

Stop Bits: Specify the number of stop bits.

Parity Bits: Specify either odd or even parity checking or no parity bit.

Port: Check the **Enable** box to enable communication through the port.

Tap the **OK** button to activate the new settings, or the **Cancel** button to return to the Service Advisor Manager menu without implementing any changes.

Power Configuration

The power configuration display allows you to select one of four power management options to conserve battery power.

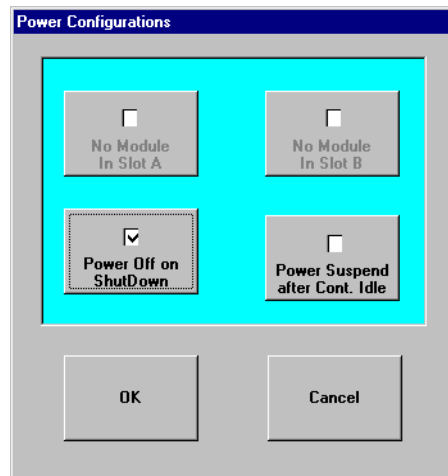

Module: Powers a module (checked), or turns off module power (unchecked). You can uncheck this box to conserve battery power (while running the Service Advisor Manager or Windows CE).

Note: Selecting this option will not start the GUI application.

Power Off on Shutdown: Configures the Tablet to shut off power automatically when you select **Shutdown** in the Service Advisor Manager (checked); or leave power ON (unchecked).

Power Suspend after Continuous Life: Activates a power suspension feature used during battery operation. When enabled (checked), power is shut off after a user defined period (in minutes) of inactivity. Use the **Battery Suspend** function to change the inactivity limit (see page 2-24).

Disable this feature (leave the box unchecked), if you plan to run tests lasting for more than the suspend time limit.

Tap the **OK** button to activate the new power mode, or the **Cancel** button to return to the Service Advisor Manager's menu without implementing any changes.

Local/Remote Setup

This Local and Remote Enable buttons in this setup tab are used to configure the Tablet for local or remote operation.

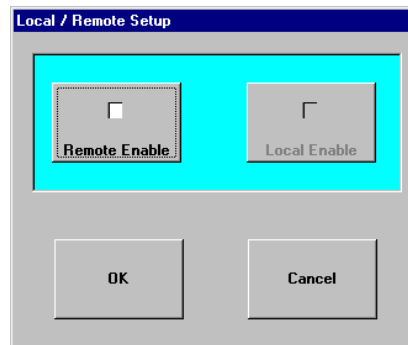

Remote Enable: Select this item to operate the Tablet through the SCPI interface (N1610A Option 500). See Chapter 7 *Remote Operation* for instructions on using SCPI commands. When remote operation is disabled the Tablet defaults to local mode. Local mode allows you to operate the Tablet through the GUI touch-screen and front-panel buttons.

Local Enable: This button is grayed out and is not operational. Its control function will be implemented in a future release.

Tap the **OK** button to activate the mode change, or the **Cancel** button to return to the Service Advisor Manager's menu without implementing a change.

Setting the Date and Time

You can use the **Date and Time** button in this setup tab to change the Tablet's date and time settings.

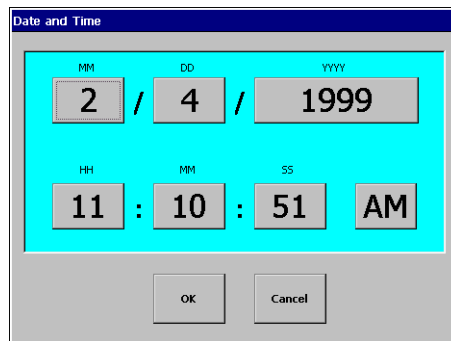

1. Select the button for the date or time field you want to change.
2. In the popup keypad, enter a new value for the field and tap **OK**.
3. Tap the **OK** button to activate the new time and date settings, or the **Cancel** button to return to the Service Advisor Manager's menu without implementing any changes.

Setting Up Network Properties

Tap the **Network Properties** button (on the Service Advisor Manager screen) to access the Network Setup control screen. You use this screen to enter Transmission Control Protocol (TCP) and Internet Protocol (IP) address and protocol identification information. This information is needed to support network communications.

When you tap an address or protocol button in either the TCP/IP or Proxy Server sections of the screen, a popup keypad appears for making changes to the selected field.

The screenshot shows the 'Network Setup' screen with two main sections: 'TCP/IP' and 'Proxy Server'. The 'TCP/IP' section includes fields for IP Address (15.9.80.100), Subnet Mask (255.255.0.0), Gateway (15.69.88.4), WINS (15.33.99.55), DNS (15.4.201.60), and an 'Enable DHCP' checkbox (unchecked). The 'Proxy Server' section includes fields for 'http://' (15.6.22.78), Port (8000), and an 'Enable Proxy' checkbox (checked). At the bottom right, there are 'OK' and 'Cancel' buttons.

IP Address: Enter the Internet Protocol (IP) address of the Tablet's Ethernet card.

Subnet Mask: Enter the identification code for the subnet mask. This code identifies the network and host.

Gateway: Enter the address of the network gateway. Gateway computers act as translators between two systems which use different transfer protocols.

WINS: Enter the Windows Internet Name Service (WINS) identification code.

DNS: Enter the Domain Naming System (DNS) identification code.

Enable DHCP: Tapping this button enables the Dynamic Host Configuration Protocol (DHCP) option. This protocol must be supported by the network.

Using the Service Advisor Tablet

Setting Up Network Properties

A proxy server performs interface functions between internal and network systems. It typically serves as a firewall between the systems.

http://: Enter the address of your network's proxy server.

Port: Enter your proxy server port assignment.

Enable Proxy: Tap this button to enable communication through a proxy server.

After you enter the desired network parameters, use the **OK** button to enter the network interface parameters, or the **Cancel** button to return to the Service Advisor Manager's menu without implementing any changes.

Adjusting Tablet Properties

Follow these steps to set or adjust properties such as speaker volume, screen contrast, power suspend, and backlight control.

1. Press the blue Tablet Properties button on the Tablet's front panel, and the following popup screen is displayed.

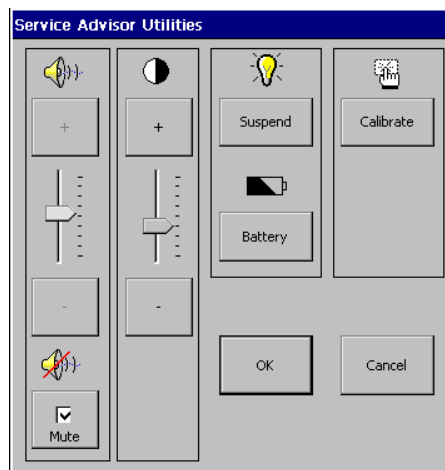

2. Define or adjust settings, as follows. When you are done, tap **OK** to activate the new settings; or, tap **Cancel** to close the popup without making any changes.



Adjust speaker volume by moving the slider up or down. Use the + and - buttons to adjust the slider's position. Check the **Mute** option to turn off the speaker.



Adjust the screen display contrast by moving the slider up or down. Use the + and - buttons to adjust the slider's position.



Configures the Tablet to suspend operation during periods of tablet inactivity. You specify the maximum number of minutes the unit can remain idle (that is, with no user activity), before the **Suspend** function halts operation and turns off the backlight of the tablet's display. Normal operation resumes once user activity is initiated.

Using the Service Advisor Tablet

Selecting **Suspend** calls the following popup. Tap **OK** to save any changes you make.

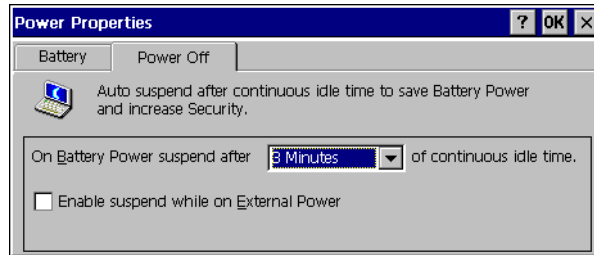

Use the **Battery Suspend** pulldown menu to set the allowable idle time limit for battery operation. Use **Power Suspend after Continuous Life** to disable this feature (see page 2-16).

Check **Enable Suspend... External Power** and use the pulldown menu that is displayed to set an idle time limit when the unit is operating on external power.

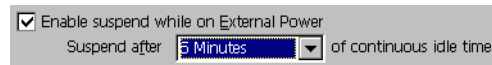

Displays information about the battery.

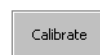
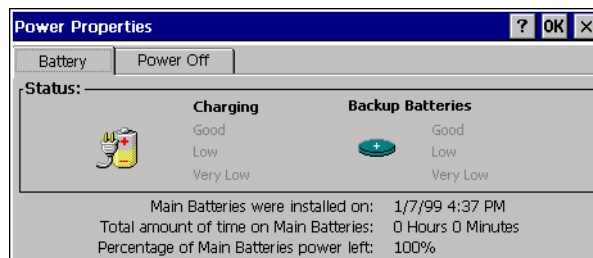

Runs a utility that calibrates the touch-screen display. Follow the on-screen prompts, and tap the middle button (**Enter**) on the Tablet front panel when you are done.

3

| | |
|---|-----|
| Connecting to the Network and Starting the IP Service Advisor | 3-2 |
| The IP Service Advisor User Interface | 3-3 |
| Configuring IP Service Advisor Defaults | 3-7 |

IP Service Advisor Software

3-1

Connecting to the Network and Starting the IP Service Advisor

This section provides instructions for starting the IP Service Advisor program on your Tablet (N1610A) and connecting to the network.

Follow these steps to connect your Tablet to the network.

1. Install a PCMCIA Type II Ethernet NIC (N1620A) in the Tablet (see page 2–7).
2. Install the Ethernet RJ-45 to RJ-45 cable between the NIC and the 10-BaseT jack on an ADSL modem, or a 10-BaseT network outlet.
3. Before running other IP tests or functions, you may want to issue a ping to ensure that the network connection is valid (see *Issuing a PING*, page 4–2).

Starting the Service Advisor Manager

1. Switch on the Tablet (press the ON/off button located on the top of the Tablet).
2. Tap the **File** button on the Service Advisor Manager screen.
3. Tap the **Run** button on the popup menu that appears.
4. Tap **IP Service Advisor** button in the program options.



Tapping the IP Service Advisor button calls up the Ping screen, the first of four IP Service test functions.

The IP Service Advisor User Interface

The IP Service Advisor user interface consists of several screens, each of which is used to run a particular test or function. Each screen contains configuration parameters for setting up the test, and an area for viewing test results. The following figure shows the major components in a typical screen.

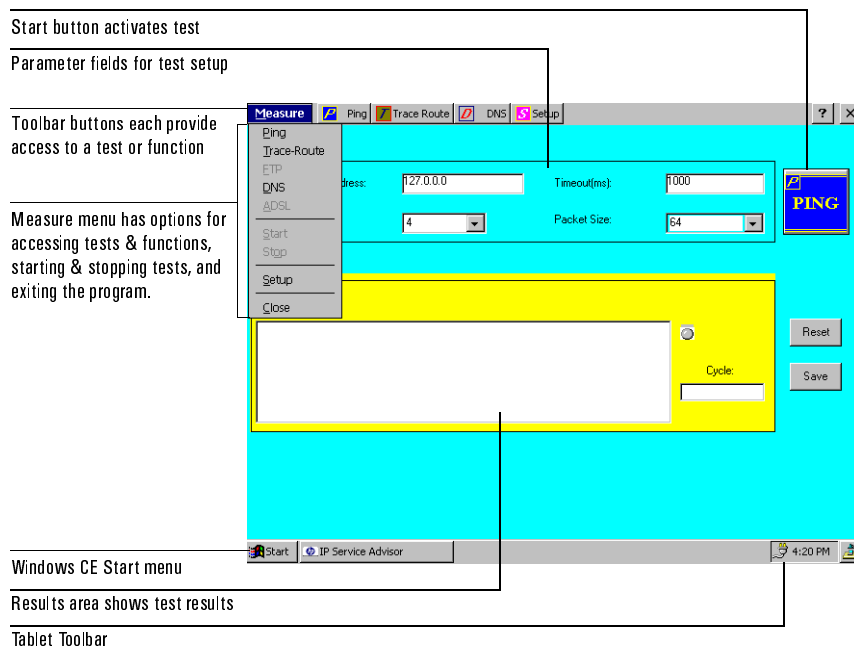

The IP Service Advisor User Interface

Following is a list of basic steps for navigating the user interface on the Tablet's touch-sensitive screen display:

- Use the stylus that came with your Tablet to select toolbar buttons, menu options, and screen fields. Simply tap the stylus onto the item to select it. (You can also use your fingertip.)
- All the test screens include a taskbar at the top left of the screen. Using the taskbar, you can move easily between the IP Service Advisor test routines.



- There is a popup menu beneath the **Measure** tab in each of the IP Service Advisor screens.

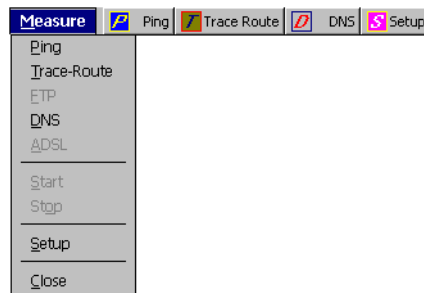

Use the menu selections to move between the four IP Service Advisor test routines. Use the **Close** option to terminate the current IP Service test routine.

Note: The FTP and ADSL IP Service tests are grayed-out because they are not currently available.

- If a field on the display screen has a down arrow, you can press the arrow to display a drop-down menu from which to select a value for the field.

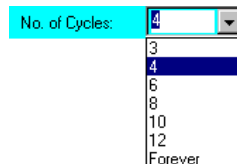

Tablet Toolbar

The Tablet toolbar is located in the lower right-hand corner of the Service Advisor Manager screens. It has four selectable icons that control Tablet-related functions.

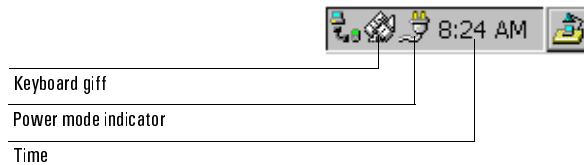

Keyboard

Tap the keyboard gliff to call a touch-sensitive keyboard.

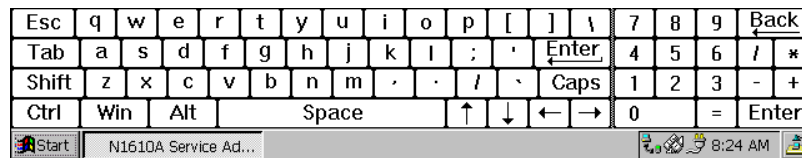

- To enter a value in a screen field, select the field and use the keyboard to type in a value. Use the **Backspace** key on the keyboard to erase an existing value.
- Tapping the **Tab** key moves the cursor to the next field in the screen.

Power Mode Indicator

The Power Mode icon shows either a power cord (for external power) or batteries when the Tablet is operating on its internal battery. When the Tablet is operating on internal battery, you can tap the battery icon to call a battery status screen which indicates the amount of battery life left.

Time

Displays the current time. You can tap this control/indicator to call the Date and Time screen described in page 2-20.

Starting and Stopping Tests

In several screens, the button used to start a test (for example, **PING** or **TRACE ROUTE**) becomes a **STOP** button once the test is started. Tap the **STOP** button to halt a test or function immediately.

Using Defaults

Reset: Tap this button to overwrite the current parameter settings with their default settings.

Save: Tap this button to save the current parameter settings as the default settings for future tests. These default settings remain in effect until you change them.

Note: See *Configuring IP Service Advisor Defaults*, page 3–7, for instructions on configuring additional default settings.

Configuring IP Service Advisor Defaults

The IP Service Advisor provides a Setup Defaults screen, in which you can define the default settings for parameters used in other test screens. Follow these steps to configure default parameter settings.

1. Tap the **Setup** toolbar button to display the Setup Defaults screen.

The screenshot shows the 'Setup Defaults' screen with the following fields and controls:

- FTP:** User: ; Password:
- ADSL Type:** Two buttons: a green button labeled 'ATU - C Downlink RX' and a red button labeled 'ATU - R Uplink TX'. A note states: 'The button with green color is the present mode of application.'
- Host Information:** Local IP Address, Gateway IP Address, Subnetmask, DNS Address, Domain Name, WINS. A checkbox for DHCP.
- Remote Host Name/Address:**
- Buttons:** 'Reset' and 'Save' buttons on the right side.

2. In the **Host Information** section, provide information for IP-related functions, such as DNS lookups and trace-route functions.

Note: Leave the Host Information fields blank if you want the Dynamic Host Control Protocol (DHCP) to provide this information (both the network and your Tablet must be configured for DHCP).

3. In the **Remote Host/Address** field, specify the host name or IP address of the node you want to use as the default destination (remote node).
4. Tap the **Setup Defaults** or **Save** button to save the current settings as the defaults. Tap **Reset** to restore the last-saved settings.

Note: The FTP and ADSL Type sections are not currently used.

IP Service Advisor Software

3-8

4

| | |
|--------------------------|-----|
| Issuing a PING | 4-2 |
| Performing a Trace-Route | 4-4 |
| Performing a DNS Lookup | 4-6 |

Testing with the IP Service Advisor

4-1

Issuing a PING

Issuing a PING

The ping test routine is useful for determining whether communication can be established with a particular remote node. The tester “pings” a remote node by sending it a request message. If the remote node is active and reachable over the network, it then issues a response message.

Note: To perform this function, the network must be running the Domain Name Service (DNS) protocol. For instructions on starting the IP Service Advisor software and connecting to the network, (see page 3–2).

1. Press the **Ping** toolbar button to display the Ping screen or select **Ping** from the popup menu beneath the Measure tab (see *The Ping Screen*, page 5–2).

The screenshot shows a software interface for performing a ping test. It is divided into two main sections: 'Parameters' and 'Results'.
The 'Parameters' section contains four input fields: 'Remote Host/Address' with the value '127.0.0.0', 'Timeout(ms)' with '1000', 'No. of Cycles' with a dropdown menu showing '4', and 'Packet Size' with a dropdown menu showing '64'. To the right of these fields is a blue button with a white icon and the word 'PING' in yellow.
The 'Results' section is a large yellow-bordered area. It contains a large empty white text box for displaying results. To the right of this box is a 'Cycle:' label above a small empty input field. Below the text box are two buttons: 'Reset' and 'Save'.

2. In the **Remote Host/Address** field, specify the host name or IP address of the node you want to ping.
3. In the **Timeout (ms)** field, specify the amount of time to allow for the test. An error is indicated if the test has not completed within this time period.

4. Use the **No. of Cycles** drop-down menu to specify the number of ping commands to issue.
5. Use the **Packet Size** drop-down menu to specify the size of the packets to send with the ping request.
6. Press the **PING** button to start the test.
7. Observe the Results area for test results. A success message means the remote node is active and accessible; an error message means it isn't. To review a list of error codes refer to page 5-3.
8. You can press the **Save** button to save the PING test results, or the **Reset** button to halt the test immediately and clear the results.

Performing a Trace-Route

The Trace-Route test routine traces a path through the network to the specified node, and returns a list of routers in the path. This test also measures how long it takes each router to process a data packet (of a user-defined size).

Note: To perform this function, the network must be running the DNS protocol. For instructions on connecting to the network and starting the IP Service Advisor software, see page 3-2.

1. Tap the **Trace Route** toolbar button to display the Trace-Route screen, or select the Trace-Route option from the popup menu beneath the **Measure** tab (see *The Trace-Route Screen*, page 5-5).

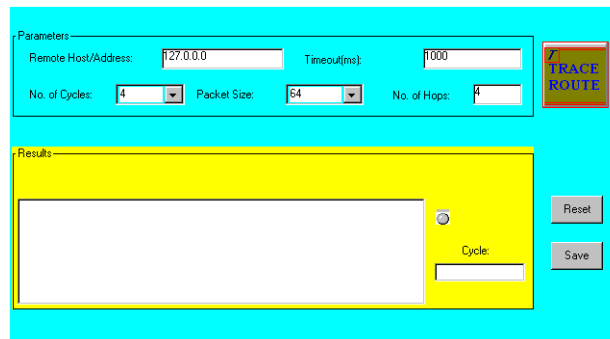

The screenshot shows a software interface for performing a trace route. It is divided into two main sections: 'Parameters' and 'Results'. The 'Parameters' section is a light blue box containing several input fields: 'Remote Host/Address' with the value '127.0.0.0', 'Timeout(ms)' with the value '1000', 'No. of Cycles' with a dropdown menu set to '4', 'Packet Size' with a dropdown menu set to '64', and 'No. of Hops' with a dropdown menu set to '4'. To the right of these fields is a red button labeled 'TRACE ROUTE'. The 'Results' section is a yellow box containing a large empty white area for displaying results. To the right of this area are two buttons: 'Reset' and 'Save'. Below the 'Results' area is a 'Cycle' label and a small input field.

2. In the **Remote Host/Address** field, specify the host name or IP address of the node you want to run the trace-route on.
3. In the **Timeout (ms)** field, specify the amount of time (in milliseconds) to allow for the trace-route. An error is indicated if the trace-route has not completed within this time period.
4. Use the **No. of Cycles** drop-down menu to specify the number of times to run the trace-route routine.
5. Use the **Packet Size** drop-down menu to specify the size of the trace-route packet (header and user data) to send to each router. (You can vary packet size to determine the effect on network performance.)
6. In the **No. of Hops** field, specify the number of routers (starting with the first) whose trace-route information you want to display.

7. Tap the **TRACE-ROUTE** button to start the test, and observe the Results area for trace-route information. See page 5–6 for a listing of error codes and their meanings.
8. You can tap one of the following buttons:
 - **STOP** button halts the trace-route routine immediately.
 - **Save** button saves the test results
 - **Reset** button clears the results

Performing a DNS Lookup

This test routine performs a Domain Name Services (DNS) lookup to determine a node's IP address or host name. For instructions on starting the IP Service Advisor software and connecting to the network, see page 3-2.

Note: To perform this function, the network must be running the DNS protocol.

1. Tap the **DNS** toolbar button to display the DNS screen, or select **DNS** from the popup menu beneath the **Measure** tab (see *The DNS Screen*, page 5-8).



2. To look up a node's IP address, check the **IP Address** radio button and specify the node's host name in the field to the right. Then, press the **Lookup Host Name** button and observe the Results area.
3. To look up a node's host name, check the Host Name radio button and specify the node's IP address (dotted decimal) in the field to the right. Then, tap the **Lookup IP Address** button and observe the Results area.

5

| | |
|---------------------------|-----|
| The Ping Screen | 5-2 |
| The Trace-Route Screen | 5-5 |
| The DNS Screen | 5-8 |
| The Setup Defaults Screen | 5-9 |

IP Service Advisor Reference

The Ping Screen

The Ping Screen

Use the Ping screen to issue ping commands to a remote node to determine whether the node is functional and accessible (see *Issuing a PING*, page 4–2).

The screenshot shows a software interface for performing a ping test. It is divided into two main sections: 'Parameters' and 'Results'.
The 'Parameters' section is at the top and contains four input fields: 'Remote Host/Address' with the value '127.0.0.0', 'Timeout(ms)' with '1000', 'No. of Cycles' with a dropdown menu showing '4', and 'Packet Size' with a dropdown menu showing '64'. To the right of these fields is a blue button labeled 'PING'.
The 'Results' section is below the parameters. It features a large, empty white rectangular area for displaying output. To the right of this area is a 'Cycle:' label followed by a small input field. Below the 'Cycle:' field are two buttons: 'Reset' and 'Save'.

Note: To perform this function, the network must be running the Domain Name Service (DNS) protocol.

Remote Host/Address: The host name or IP address (dotted decimal) of the node you want to ping.

No. of Cycles: The number of ping cycles to run. For each cycle, the Tablet issues a separate ping command, and displays the results. Select **Forever** to run the test continuously.

Timeout (ms): The amount of time, in milliseconds, to allow for each ping cycle (default = 180 ms). An error occurs if a cycle takes longer than this.

Packet Size: The size (in bytes) of the packet to use for the ping. Note that packet size includes header and user data.

Menu Buttons

Use the menu buttons to run the test and configure the default settings.

PING: Tapping this button starts the ping test. Once the test is started, the **PING** button becomes a **STOP** button. Tap **STOP** to halt the test immediately.

Reset: Overwrites current parameter values with their default settings, which you previously specified using the **Save** button or the Setup Defaults Screen.

Save: Saves the current parameter settings as the default settings for future ping tests. These default settings remain in effect until you change them.

Results

The Results area presents test status. For each ping cycle, the Tablet displays a message indicating whether the ping passed or failed.

Success message: Shows packet size, time spent at the node, and the time-to-live (TTL) value.

Failure message: Shows an error code indicating the cause of the failure (see below).

Ping Error Messages

| Error Code | Description |
|------------|------------------------------------|
| 11001 | Buffer is too small |
| 11002 | Destination network is unreachable |
| 11003 | Destination host is unreachable |
| 11004 | Destination port is unreachable |
| 11005 | Destination port is unreachable |
| 11006 | Has no response |
| 11007 | Bad option |
| 11008 | Hardware error |

The Ping Screen

Ping Error Messages, continued

| Error Code | Description |
|-------------------|-------------------------------|
| 11009 | Packet too large |
| 110101 | Request timed out |
| 11011 | Bad request |
| 11012 | Bad route |
| 11013 | TTL expired during transit |
| 11014 | TTL expired during reassembly |
| 11015 | Parameter problem |
| 11016 | Source quench |
| 11017 | Option too large |
| 11018 | Bad destination |

Soft LEDs: Shows test status: passing (green) or failing (red).

Cycle: The number of ping cycles that have completed, of the total to be run.

The Trace-Route Screen

Using the Trace-Route screen, you can trace a path through the network to a specified node, and see a list of the routers in the path (see *Performing a Trace-Route*, page 4–4). The Trace-Route test routine also measures how long it takes each router to process a data packet.

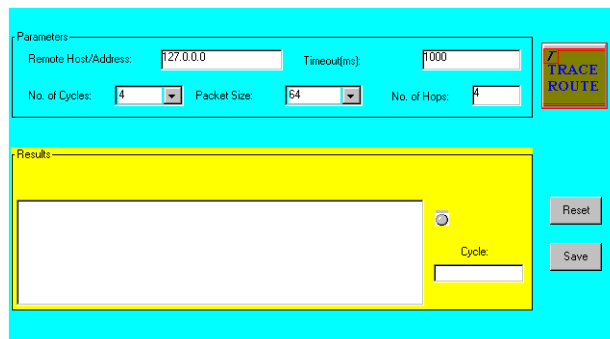

The screenshot shows a web-based interface for performing a trace route. It is divided into two main sections: 'Parameters' and 'Results'.
The 'Parameters' section contains several input fields and a button:

- 'Remote Host/Address': A text input field containing '127.0.0.0'.
- 'Timeout(ms)': A text input field containing '1000'.
- 'No. of Cycles': A dropdown menu with '4' selected.
- 'Packet Size': A dropdown menu with '64' selected.
- 'No. of Hops': A text input field containing '4'.
- A red button labeled 'TRACE ROUTE'.

The 'Results' section contains:

- A large empty rectangular area for displaying the trace results.
- A 'Cycle' label with a small input field next to it.
- A 'Reset' button.
- A 'Save' button.

Note: To perform this function, the network must be running the DNS protocol.

Remote Host/Address: The host name or IP address (dotted decimal) of the node to perform the trace-route on.

No. of Cycles: The number of times to run the trace-route. Each trace-route cycle traces the route through the network and reports results. Select **Forever** to run the test continuously.

Timeout (ms): The amount of time, in milliseconds, to allow for each trace-route cycle (default = 180 ms). An error occurs if a cycle takes longer than this.

Packet Size: The size (in bytes) of the data packet sent to each router in the path. Note that packet size includes header and user data.

No. of Hops: The number of routers to display trace-route information for (1 to 9). For example, if there are 7 routers in the path and you specify 4, the tester only displays trace-route information for the first 4 routers in the path.

The Trace-Route Screen

Menu Buttons

Use the menu buttons to control the test and the default test settings.

TRACE ROUTE: Tapping this button starts the trace-route test. Once the test is started, **TRACE ROUTE** becomes a **STOP** button. Tap **STOP** to halt the test immediately.

Reset: Overwrites current parameter values with their default settings (which you previously specified using the **Save** button or the Setup Defaults Screen).

Save: Saves the current parameter settings as the default settings for future trace-route tests. These default settings remain in effect until you change them.

Results

The Results area presents test results. For each trace-route cycle, the tester displays a message indicating whether the trace-route passed or failed.

Note: The Results field only presents trace-route information for the number of hops specified, beginning with the first.

Success messages: Show the packet size, time required to arrive at the node, and the TTL value. In addition, the message includes a list of the routers (*hops*) in the trace-route path.

Failure messages: Contain an error code indicating the cause of the failure (see below).

Ping Error Messages

| Error Code | Description |
|------------|------------------------------------|
| 11001 | Buffer is too small |
| 11002 | Destination network is unreachable |
| 11003 | Destination host is unreachable |
| 11004 | Destination port is unreachable |
| 11005 | Destination port is unreachable |
| 11006 | Has no response |

Ping Error Messages, continued

| Error Code | Description |
|-------------------|-------------------------------|
| 11007 | Bad option |
| 11008 | Hardware error |
| 11009 | Packet too large |
| 110101 | Request timed out |
| 11011 | Bad request |
| 11012 | Bad route |
| 11013 | TTL expired during transit |
| 11014 | TTL expired during reassembly |
| 11015 | Parameter problem |
| 11016 | Source quench |
| 11017 | Option too large |
| 11018 | Bad destination |

Soft LEDs: Show test status: passing (green) or failing (red).

Cycle: The number of trace-route cycles that have completed, of the total specified in No. of Cycles.

The DNS Screen

The Domain Name Services (DNS) screen enables you to “look up” the IP address of a host, or the host name of an IP address.



Note: To perform this function, the network must be running the DNS protocol.

IP Address: Check this radio button to configure the Tablet to find the IP address of the host name specified in the name/address field.

Host Name: Check this radio button to configure the Tablet to find the host name of the IP address specified in the name/address field.

In the **name/address** field, to the right of the radio buttons, specify the IP address (dotted decimal) or host name you want to look up.

Menu Buttons

The menu button corresponds to the selected radio button.

Lookup Host Name: Tap this button to return the host name of the specified IP address. (Displayed when the IP Address is selected.)

Lookup IP Address: Tap this button to return the IP address of the specified host name. (Displayed when the Host Name is selected.)

Results

The **Results** area displays the IP address or host name obtained by the DNS lookup.

The Setup Defaults Screen

This screen is used to define the parameter settings used as default values in other IP Service Advisor test screens.

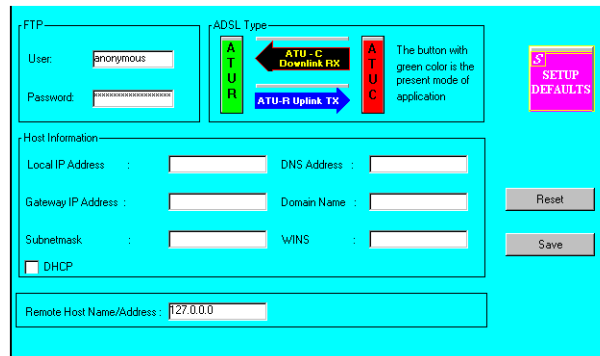

Note: The FTP and ADSL Type sections of the Setup Default screen are currently not used.

Host Information

The Host Information section contains the settings to use for IP-related functions (such as DNS lookups and trace-route functions).

Note: Leave the Host Information fields blank if you want the Dynamic Host Control Protocol (DHCP) to provide this information. To use this option, both the network and the Tablet must be configured for DHCP. If you are not sure of the value to assign to a Host Information field, see your system or network administrator.

Local IP Address: The Tablet's IP address (dotted decimal).

Gateway IP Address: The IP address (dotted decimal) of your network's default router.

Submask: An identification code identifying the network and host.

DNS Address: The IP address (dotted decimal) of your network's domain name server.

Domain Name: The name of the domain your network is part of.

IP Service Advisor Reference

The Setup Defaults Screen

WINS: The Windows Internet Name Service (WINS) identification code.

Remote Host Name/Address

The **Remote Host Name/Address** field defines the node you want to use as the default remote host in other test screens. Specify the node's host name or IP address here.

Menu Buttons

Use the menu buttons to save or change field settings.

Reset: Overwrites current parameter values with their default settings which you previously specified.

Save: Tap this button to save the current settings as the Tablet's default parameter values (to be used in other tests and functions).

6

| | |
|--|------|
| SACompanion at a Glance | 6-2 |
| Connect a Companion PC to a Tablet | 6-3 |
| Using an HP OmniBook 800 | 6-4 |
| Installing SACompanion | 6-7 |
| Start the SACompanion Program | 6-12 |
| Set the Communications Settings | 6-14 |
| Configuring the Ethernet Interface | 6-16 |
| Upgrade System or Module Software | 6-19 |
| Check Software Revision Levels | 6-19 |
| Upgrade Service Advisor Software | 6-22 |
| Upgrade Module Software | 6-24 |
| Remotely Launching a Module | 6-25 |
| Remotely Powering On an Installed Module | 6-26 |
| Close the Module's Software | 6-27 |
| Remove a Module From a Tablet | 6-28 |
| Copy Files to and From the Flash PC Card | 6-29 |
| Deleting Files | 6-32 |
| SCPI Tools | 6-33 |
| Exit the SACompanion Application | 6-34 |

Using the SACompanion Software

SACompanion at a Glance

The SACompanion software is an easy to use Windows-based software tool that:

- Supports the copying of data files between an IBM compatible PC and a Tablet or its installed modules
- Supports the remote setup and control of a Tablet using SCPI (Standard Commands for Portable Instruments) command strings when option 500 is enabled
- Provides PC-based file management functions for files residing in a Tablet and its installed modules
- Allows you to control a Tablet and its installed modules remotely from a PC using facsimiles of the Tablet's touch sensitive screen displays
- Provides Ethernet capability that lets you connect your Tablet to an Ethernet network. This capability provides access to the IP Service Advisor feature (see *IP Service Advisor Software*, page 3-1), lets you remotely control your Tablet, and lets you upgrade your module's software remotely through the network.

Companion PC Requirements

To install and run the SACompanion software successfully, you must have:

- an IBM compatible PC (referred to in this chapter as a Companion PC) connected to your Tablet
- a CD ROM drive
- Windows 95[®] (or later) or Windows NT[®] operating system running on your PC
- 30 Meg of available disk space

Connect a Companion PC to a Tablet

You can attach a companion PC to a Tablet (N1610A) to copy software upgrades to the Tablet, and to modules installed in the Tablet.

1. On top of the Tablet, open the panel that protects the serial and parallel ports.

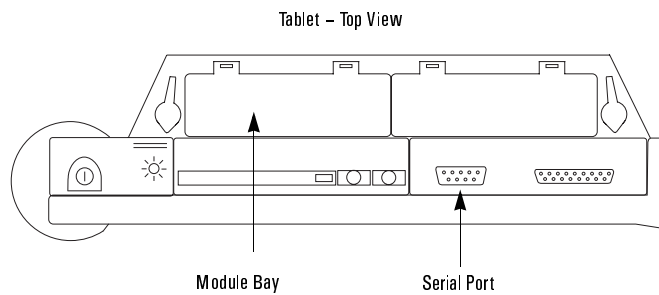

2. Install a DB-9 (null-modem) cable between the Tablet's serial port and a COM port on your PC.
3. Continue to page 6-7 for instructions on installing the SACompanion software on your PC.

Using an HP OmniBook 800

You can use an HP OmniBook 800 as a companion PC to download software upgrades to a Tablet. After connecting an OmniBook laptop to a Tablet, complete the following procedure to ensure that the OmniBook can communicate properly with a Tablet.

1. Power ON the OmniBook.
2. Access the Windows® Control Panel (Start -> Settings -> Control Panel).

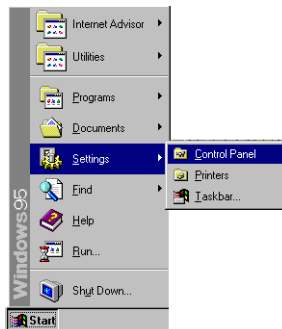

3. Select the **System** icon.
4. On the System Properties screen, select the **Device Manager** tab.

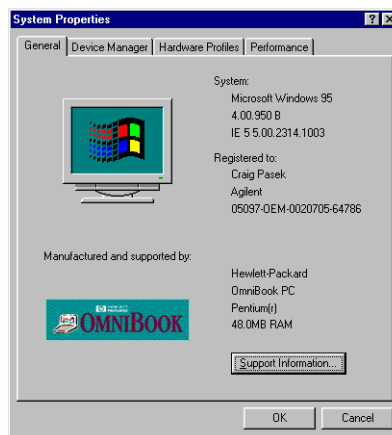

5. Select the **Ports** item, and then the **Communications Port (COM1)** item.

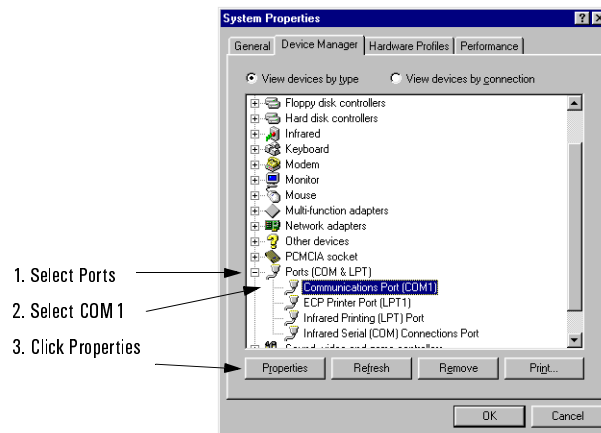

6. Tap the **Properties** button.
7. On the Communications Port Properties screen, select the **Port Settings** tab, and then tap the **Advanced** button.

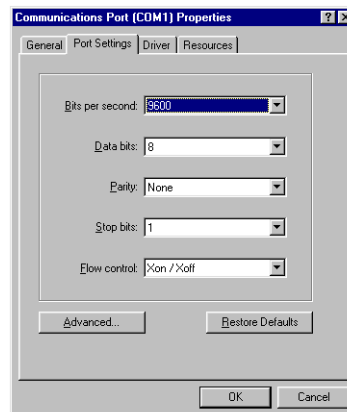

Using the SACompanion Software

Using an HP OmniBook 800

8. On the Advanced Port Settings screen, set the Receive and Transmit Buffer settings, as shown in the following screen.

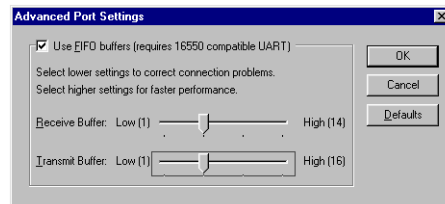

9. Tap **OK** on this screen to save the settings. Continue to tap **OK** on all the previous screens to return to the Control Panel screen. Close the Control Panel screen, and continue to page 6–7 for instructions on installing the SACompanion software on your OmniBook laptop.

Installing SACompanion

The SACompanion software is supplied on a CD-ROM (part number: 5011-4459, rev. 1.20). After connecting your companion PC to your Tablet (see *Connect a Companion PC to a Tablet*, page 6-3), you are ready to install the complete SACompanion software package, or the files needed to upgrade your Tablet's system software or the module software.

Follow these steps to install the SACompanion software on a Companion PC.

1. Power ON the Tablet and connected Companion PC.
2. Close any open applications on the Companion PC.
3. Insert the SACompanion software CD into the CD drive located on the companion PC connected to a Tablet.
4. Select **Run** from the Start menu and type **d:\setup** (or specify the CD drive) on the Run screen. Then, tap **OK**.

Note: If you have your PC set to automatically launch a CD you insert into the CD drive, you can skip this step.

5. Tap the **Next** button when you see the welcome screen.

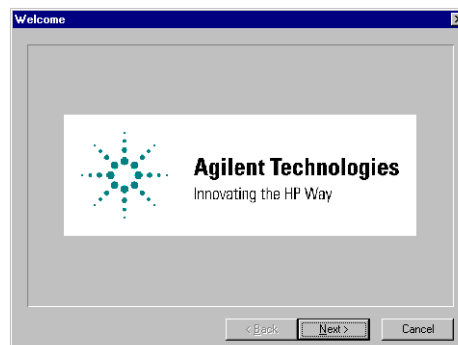

6. Tap the **Next** button when the second welcome screen appears.

Using the SACompanion Software

Installing SACompanion

7. When the Readme Information screen appears, you'll see a list of all the software included on the CD. Make a list of the software files and release information. You can use this list to determine which files you need to install later in this procedure.

Tap **Next** to continue.

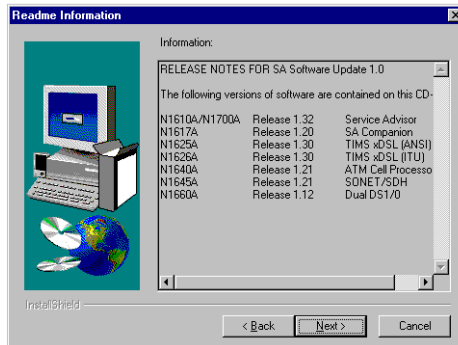

8. Enter user information and tap **Next** when the following screen appears.

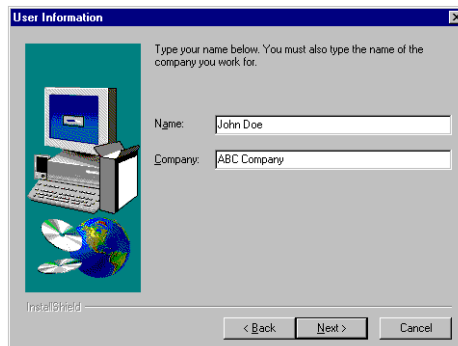

9. Tap **Next** to save the SACompanion software in the default directory (c:\SACompanion).

To save the software in a different location, tap **Browse** and select the desired drive. The destination you specify must be at the root level (for example, c:\RemoteSA). Then tap **Next** to continue.

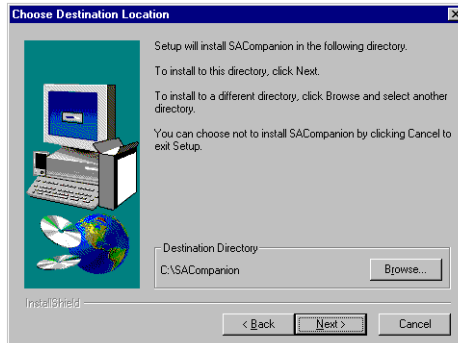

10. On the Setup Type screen, select one of the installation options (*Typical or Custom; the Compact option is not implemented yet*). Then, make sure the destination directory is the one you specified on the previous screen, and tap **Next** to continue.

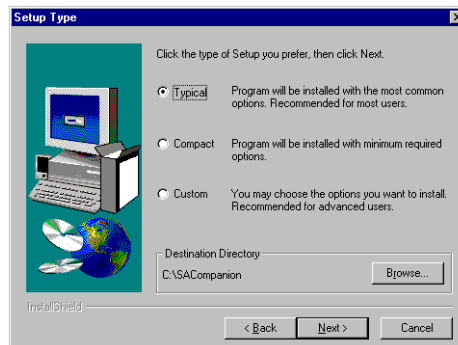

| Installation Option | Description |
|---------------------|--|
| Typical | Installs all the SACompanion files on the destination drive. |
| Custom | Lets you select the files you want to download to the destination drive. |

Using the SACompanion Software

Installing SACompanion

11. If you selected the *Custom* installation option, the following screen appears. If you selected *Typical*, continue to the next step.

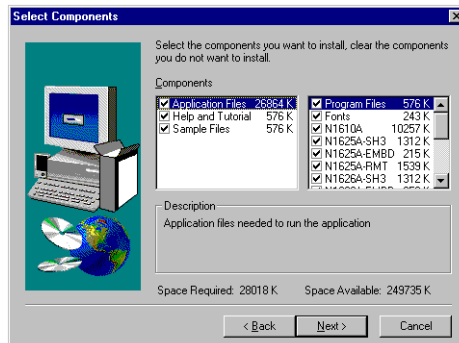

- Select the Application Files component in the left display area.
 - To deselect files that you don't need, click on the checked box which appears in front of each filename. You will notice that the Applications Files size in the left column decreases in size as you deselect an item.
 - Tap **Next** when you have deselected all the unnecessary files, and continue to the next step.
12. Tap **Next** to save the software files in the default program folder (SACompanion folder).

To save the software files in a different program folder, type a new name in the field, or select a folder name from the Existing Folders list. Then tap **Next** to continue.

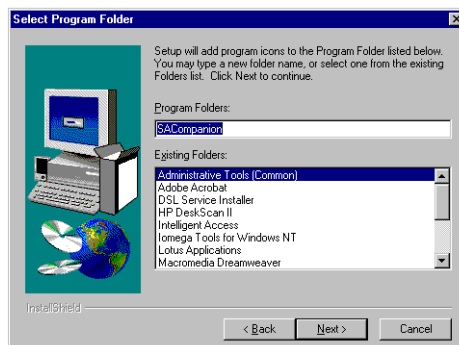

- Review the information displayed on the following screen and tap **Next** to continue.

If the displayed information is incorrect, tap **Back** to return to the appropriate screen and make the necessary correction. Then tap **Next** until the following screen appears.

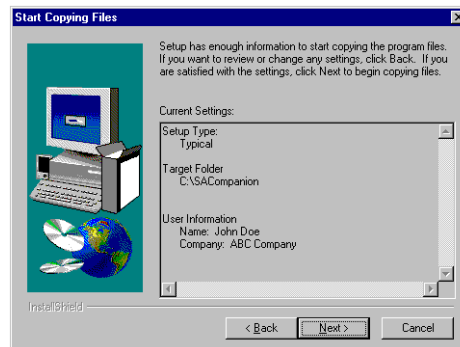

- It takes a few minutes for the SACompanion software installation to complete.

When the following screen appears, select, “Yes, I want to restart my computer now”, and tap **Finish** to complete the installation.

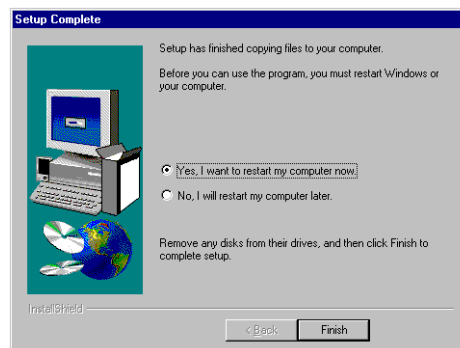

When the SACompanion software download process is complete, the Companion PC power-cycles off and then ON.

Using the SACompanion Software
Start the SACompanion Program

Start the SACompanion Program

After connecting the hardware and installing the SACompanion software, you can start the SACompanion program just as you would start any other installed Windows program from the Start menu.

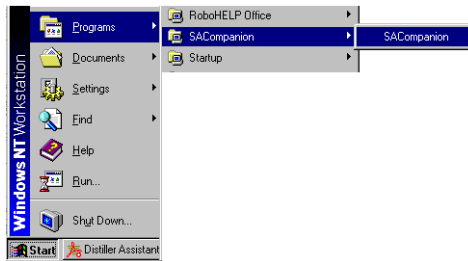

Note: If you want to create a shortcut icon on your desktop, refer to your Windows documentation.

Using the SACompanion Program for the First Time

The first time you start the SACompanion program, you'll see the following error message. This message appears because you need to set the proper communications settings. Tap **OK** to continue and see *Set the Communications Settings*, page 6-14.

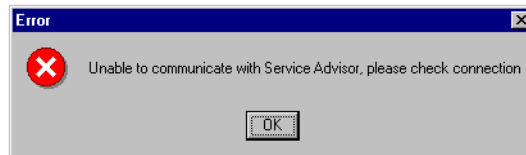

SACompanion Toolbar

When the SACompanion program starts, you see the following toolbar appear. This toolbar offers eight buttons, seven of which are currently functional (the **Agilent Options** button is not available and is “grayed out”).

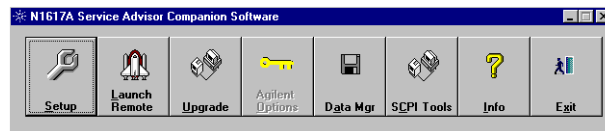

Setup: Lets you set access the Communications Settings screen to configure your RS-232 or Ethernet interface in your PC. The Tablet being remotely controlled must be configured with the same interface settings.

Launch Remote: Lets you remotely control modules installed in a Tablet from your PC.

Upgrade: Lets you copy program software from your PC, to a Tablet and its installed test and interface modules.

Agilent Options: In a future release of the SACompanion software, this option will allow you to enable optional features on one or more Tablet, remotely, from your PC.

Data Mgr: Lets you transfer data files between your PC and the Tablet's optional PC card or its installed modules.

SCPI Tools: Lets you control a Tablet, remotely, from a PC by entering individual SCPI command strings. Refer to the SCPI chapter in your module's User Manual for information about the SCPI commands.

Info: Displays information about the connected Tablet, the installed interface, and the installed module(s).

Exit: Closes the SACompanion application and returns you to the Windows desktop.

Set the Communications Settings

The SACompanion **Setup** button opens a Communications Settings display for setting up your RS-232 or Ethernet interface in your Tablet. The Tablet being remotely controlled must be configured with the same port settings (See *Initial Configuration*, page 3-8).

The first time you access the SACompanion software, you must select COM2 as the port that you are using to remotely control a Tablet.

To select the COM2 port, follow these steps.

1. Tap the **Setup** button on SACompanion toolbar (see *SACompanion Toolbar*, page 6-13).
2. Select the following port settings.

| Port Setting | Suggested Value |
|--------------------|--|
| Type of connection | Serial or Ethernet (if you select Ethernet, continue to page 6-16) |
| Baud rate | 115,200 |
| Parity | None |
| Data bits | 8 |
| Stop bits | 1 |
| Port | COM2 |

Using the SACompanion Software
Set the Communications Settings



Now that the port settings are correct, you'll see the **Launch Remote** button change from an inactive (grayed out) to an active condition. When the button becomes active, you can tap it to start testing with an installed module.

Configuring the Ethernet Interface

The Ethernet interface option lets you upgrade your module's software remotely through the network.

Note: You cannot upgrade your Tablet's (Service Advisor) system software when using the Ethernet interface.

Finding Your Tablet's Network Address

Before you begin the process of remotely upgrading your module's software, you must know the network address assigned to a Tablet.

1. Access the Service Advisor Manager program running on the Tablet that has the module you want to upgrade.
2. Tap the **Setup** tab, and then tap the **Network Properties** button.

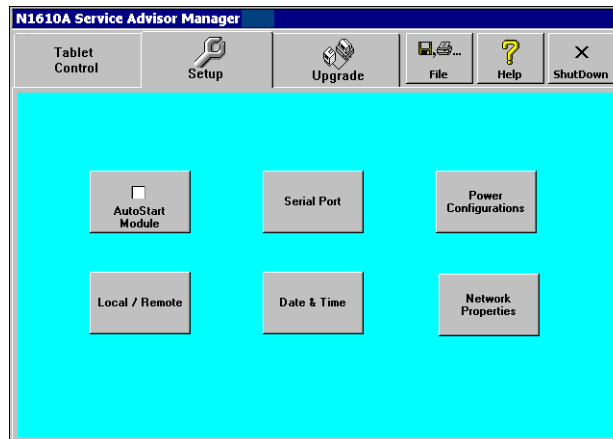

Using the SACompanion Software
Configuring the Ethernet Interface

3. When the Network Setup screen appears, look at the IP Address field and record the address. Tap **OK** to return to the Setup screen.

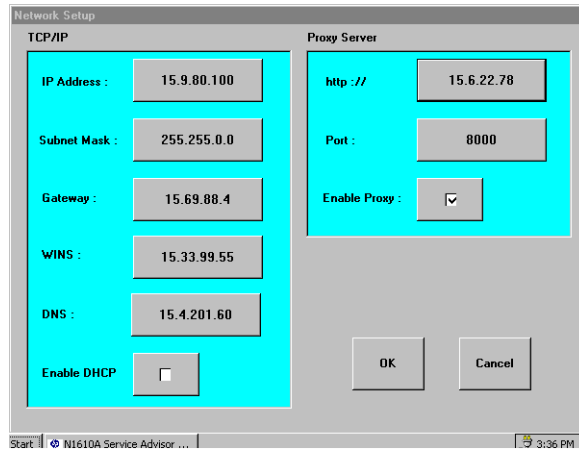

If you do not see an IP address on this screen, it may mean that your network is not responding. Turn off your Tablet and then turn it back ON.

Selecting the Ethernet Option in SACompanion

1. Access the SACompanion program running on your PC.
2. Tap the **Setup** button on the SACompanion toolbar (see **SACompanion Toolbar**; page 6–13).

Using the SACompanion Software
Configuring the Ethernet Interface

3. Select the **Ethernet** option in the Type section and tap **OK**.



4. When the following Setup screen appears, enter the Tablet's network IP address.

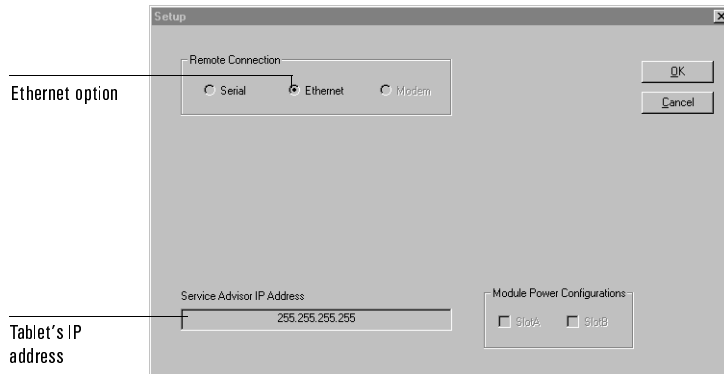

Remotely Upgrading Your Module

To remotely upgrade your module's software via an Ethernet connection, see *Remotely Upgrading Your Module*, page 6–18. The module upgrade procedure is the same whether you are upgrading locally on your Tablet or remotely via the Ethernet connection.

Upgrade System or Module Software

When new revisions of the Tablet (Service Advisor) and module software are released, you'll need to upgrade your equipment. The SACompanion toolbar contains an **Upgrade** button, which calls a display used to copy program software from your PC, to the Tablet and its installed test and interface modules.

The following sections explain how to check the software revision levels, upgrade the Tablet's software, upgrade a module's software, and remotely launch or power ON an installed module.

Check Software Revision Levels

The SACompanion **Info** button calls a display screen that provides information about the Tablet being controlled and its installed interface and test modules. To determine if you need to upgrade your equipment, compare the software revisions running on your equipment with the revisions listed in the Readme.txt file loaded on the SACompanion CD.

1. Open the SACompanion folder located on your C: drive on your PC.

Note: If you specified another drive during the SACompanion installation process (see page 2–6), locate the SACompanion folder on that drive.

2. Open the README.TXT file. It should look something like the following screen.

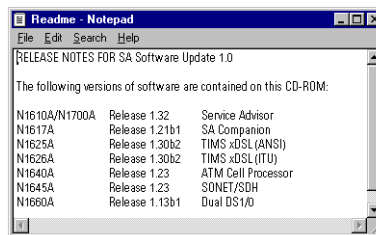

3. Reduce the screen size, but make sure you can see all the information.

Using the SACompanion Software

Check Software Revision Levels

4. Tap the **Info** button on the SACompanion toolbar. This screen indicates the revisions of the software currently running on your equipment.

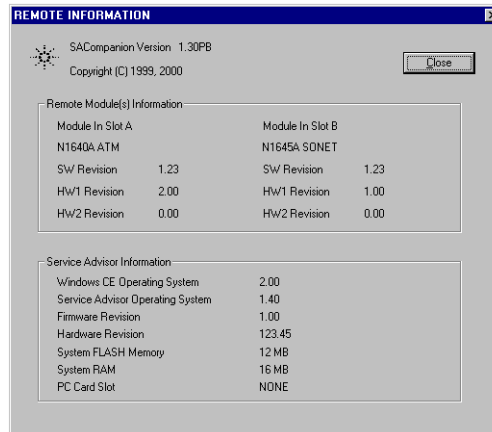

Note: Make sure you have a module(s) installed in the Tablet to see accurate information on the Remote Information screen.

5. Compare the README.TXT revisions with the revisions listed in the Remote Information screen to determine what needs to be upgraded on your equipment; Service Advisor System and/or module software.

Module Information

The top half of the screen presents information about any modules installed in the Tablet.

Note: You must have the “physical” module installed in the Tablet to see revision information for a module.

Module Name – The type of module installed in this slot.

SW Revision – The module’s software revision.

HW Revision – The module’s hardware revision.

Service Advisor Information

The lower half of the screen presents information about the Tablet.

Windows CE Operating System – The current version number of the Windows CE operating system software, which runs on the Tablet.

Service Advisor Operating System – The current version number of the Tablet's (Service Advisor's) system software.

Firmware Revision – The Tablet's firmware revision number.

Hardware Revision – The Tablet's hardware revision number.

System FLASH Memory – The amount of flash memory available in the Tablet.

System RAM – The amount of random-access memory available on the Tablet.

PC-Card Slot – The type of PC card installed in the Tablet.

Upgrade Service Advisor Software

If you need to upgrade the Service Advisor's software, complete these steps.

1. Tap the SACompanion toolbar **Upgrade** button.
2. When the Software Upgrade screen appears, tap the **Service Advisor** button.

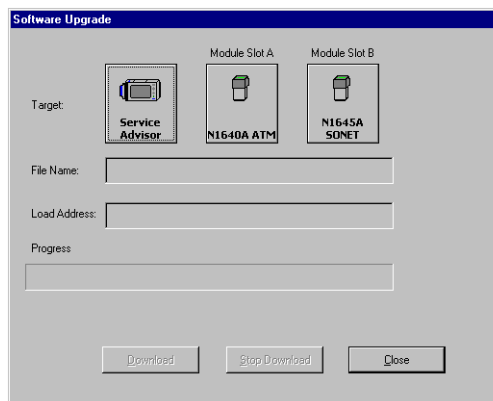

3. Tap the **Download** button on the Software Upgrade screen.
4. You'll see the following message on the lower portion of the screen.

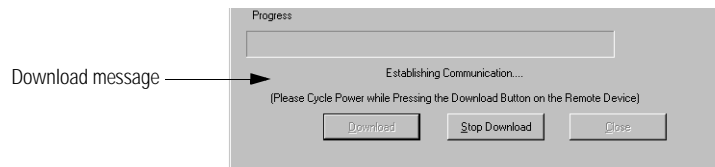

5. Press the **blue Tablet Properties** button (located on the front side of the Tablet) and the On/Off switch (located on the top left of the Tablet).

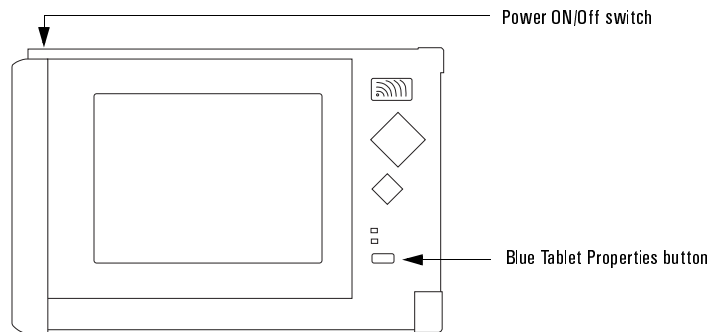

6. When you see the “Communication Established” message, release the **blue Tablet Properties** button.

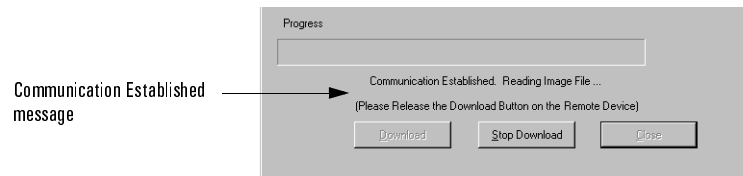

- Note:** Tap the Stop Download button to terminate the download process if you did not tap the blue Tablet Properties button and ON/Off switch within the allotted amount of time.
7. During the upgrade process, you'll see the Progress bar graph reflect the percentage of the download operation completed.
 8. When the download is complete, tap the **Close** button. The Software Download screen closes and control returns to the SACompanion toolbar.

Upgrade Module Software

If you need to upgrade a module's software, make sure the module is properly installed (see page 1–9). Then complete these steps.

1. Tap the SACompanion **Upgrade** toolbar button.
2. When the Software Upgrade screen appears, tap a module button.

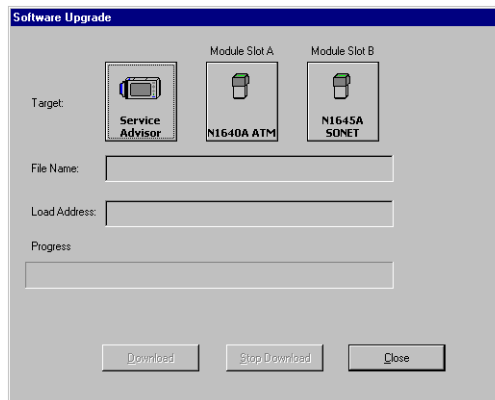

3. Tap the **Download** button to initiate the download process.

Tap the **Stop Download** button to terminate the download process. When the confirmation screen appears, tap **Yes** to stop the download.

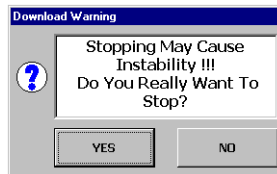

4. During the upgrade process, you'll see information appear in the screen's fields.

File Name – Displays the name of the file being copied.

Load Address – Displays the load address of the file being copied.

Progress – a bar graph showing the percentage of the download operation completed.

5. When the download is complete, tap the **Close** button. The Software Download screen closes and control returns to the SACompanion toolbar.

Remotely Launching a Module

The **Launch Remote** button lets you remotely control modules installed in a Tablet. To start a module, follow these steps.

1. Tap the **Launch Remote** button on the SACompanion toolbar (see *SACompanion Toolbar*, page 6–13). A button for each module installed in the Tablet appears on the Product Remote Launch screen.

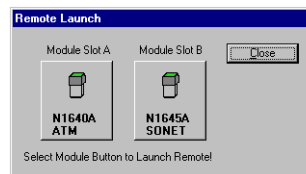

2. Tap the button for the module you want to start. If you installed a TIMS module, only one module button appears.

The module's main test screen appears. The simulated control screens allow you to control the module remotely using the PC's mouse to select screen options. The **Launch Remote** feature is grayed out if option 500 is not enabled. Refer to the module's user manual for details of the screen control functions.

Note: Only one remote device can be controlled at any given time.

Remotely Powering On an Installed Module

You can remotely power ON a module at any time. To do so, follow these steps.

1. Tap the **Setup** button on SACompanion toolbar (see *SACompanion Toolbar*, page 6–13).
2. When the Setup screen appears, tap the **Slot A** or **Slot B** option in the Module Power Configurations section to power ON a module in slot A or B. If you have a module in both slots, tap both the **Slot A** or **Slot B** options

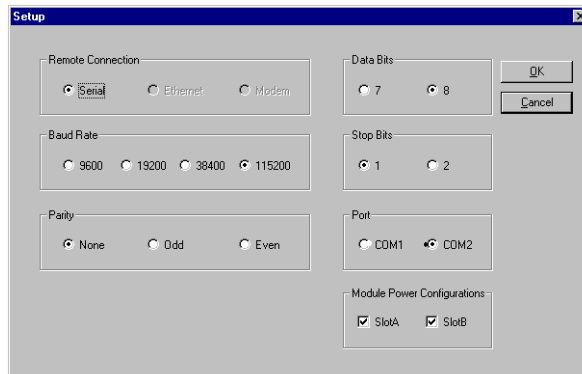

Close the Module's Software

When you are finished using a module, follow these steps to terminate the module's software.

1. Stop a running test, if applicable.
2. Select the module's toolbar File -> Exit option. For example, if you are running a DS1/0 test module, you must exit the DS1/0 application as shown:

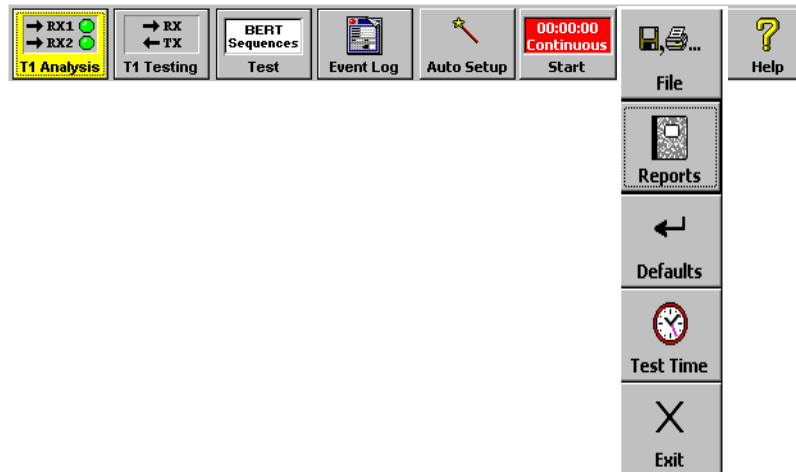

3. Tap the **File** button and select the **Exit** option from the module's toolbar. This closes the module application completely.
4. Tap the **Close** button when the Product Remote Launch screen appears.
5. Tap the **Exit** button on the SACompanion toolbar.

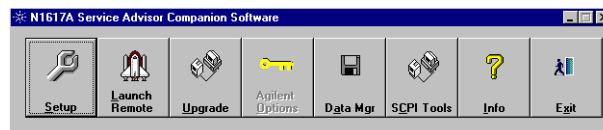

It is now safe to remove the module from the Tablet.

Note: Removing a module before completing this procedure may cause your Tablet to stop operating properly.

Remove a Module From a Tablet

To remove a module, complete the *Close the Module's Software* procedure (page 6-27), and then pull the module from the module bay.

Note: If you remove a module without closing the module's application first, the Tablet or Companion PC will not function properly.

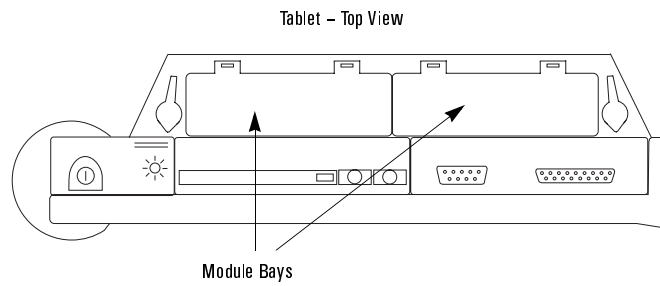

Copy Files to and From the Flash PC Card

The **Data Mgr** toolbar button calls a Data Manager control screen designed to simplify the transfer of data files between your PC and a Tablet's optional PC card or its installed modules.

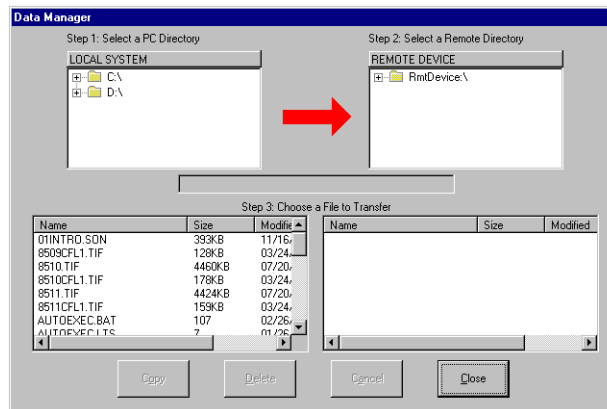

Copying Files From a PC

To transfer program files from your PC to a Tablet's PC card or modules:

1. In the window titled LOCAL SYSTEM, select the directory from which the files are to be transferred. When a directory is selected, its contents appear in the "Choose a File to Transfer" window.
2. In the window titled REMOTE DEVICE, select the PC card or module directory to which the program files are to be transferred.
3. In the window titled "Choose a File to Transfer," select the program file (or files) to be transferred. If you want to transfer more than one file, hold down the **Ctrl** button on the PC's keyboard, then use the PC's mouse to individually select the files. If you want to transfer a group of files, hold down the **Shift** button on the keyboard, and then drag the cursor to select the files.

Note: When a file is selected from the PC directory, the direction arrow in the center of the screen may change direction to indicate the direction of the file transfer. In this case, the arrow should point right, from the PC directory to a Remote directory.

Using the SACompanion Software
Copy Files to and From the Flash PC Card

4. Tap the **Copy** button at the bottom of the control screen to initiate the file transfer. As each file transfer is completed, the file's name, size, and the date last modified appears in destination window. When the transfer is complete, you'll see "Completed!" in the transfer display field.

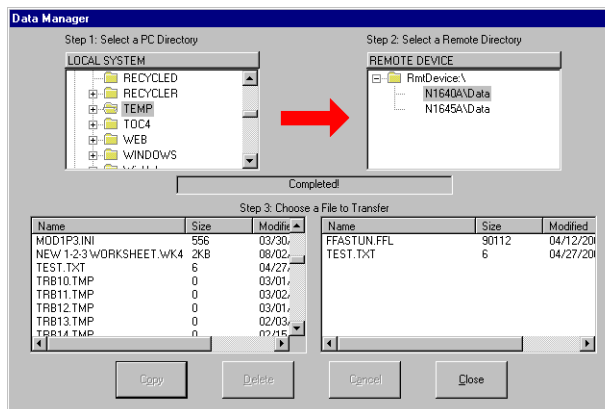

5. Tap the **Cancel** button to cancel the transfer. You'll see the following message:
File Transfer Warning. Stopping may corrupt the file being transferred!!! Do you really want to stop?

Tap **OK** to cancel the file transfer, or tap **Cancel** to continue the file transfer process. Remember that you can always delete a transferred file after the transfer is complete to avoid corrupting any files (see *Deleting Files*, page 6-32).

Copying Files to a PC

To transfer program or data files from a Tablet's PC card or installed modules, to your PC:

1. In the window titled REMOTE DEVICE, select the PC card or module directory from which the program files are to be transferred.
2. In the window titled LOCAL SYSTEM, select the directory on the PC where the files will be transferred.
3. In the window titled "Choose a File to Transfer," select the program file (or files) to be transferred. If you want to transfer more than one file, hold down the **Ctrl** button on the PC's keyboard, then use the PC's mouse to individually select the files. If you want to transfer a group of files, hold down the **Shift** button on the keyboard, and then drag the cursor to select the files.

Note: The direction arrow in the center of the screen may change direction to indicate the direction of the file transfer. In this case the arrow should point left from the Remote directory to a PC directory.

4. Tap the **Copy** button at the bottom of the control screen to initiate the file transfer. As each file transfer is completed, the file's name, size, and the date last modified appear in destination window.
5. Tap the **Cancel** button to cancel the transfer. You'll see the following message:

File Transfer Warning. Stopping may corrupt the file being transferred!!! Do you really want to stop?

Tap **OK** to cancel the file transfer, or tap **Cancel** to continue the file transfer process. Remember that you can always delete a transferred file after the transfer is complete to avoid corrupting any files (see *Deleting Files*, page 6-32).

Deleting Files

Deleting Files

You can delete files from the PC card installed in your Tablet or an installed module.

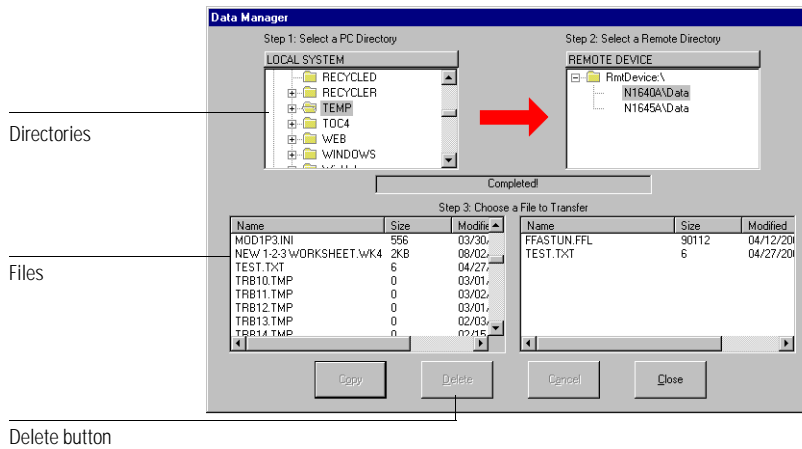

1. Select the directory in which the files reside in either the window titled LOCAL SYSTEM or REMOTE DEVICE.
2. Select the file(s) and tap the **Delete** button.

SCPI Tools

The SACompanion **SCPI Tools** button calls up a display that allows you to remotely control a Tablet from a PC by entering individual SCPI command strings.

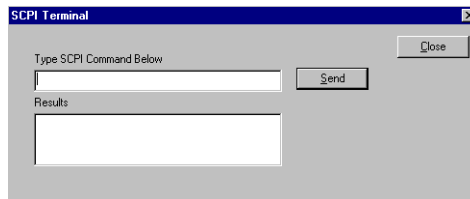

To control a Tablet from your PC:

- Enter the SCPI command string in the SCPI Command field and tap the **Send** button to initiate the command transfer.
- When the command calls for status or results information from the Tablet, the information is returned and displayed in the SCPI Terminal's Results field.
- To exit the SCPI Terminal and return to the SACompanion toolbar, tap the **Close** button or the window's exit control (X) to return to the toolbar display.

Using the SACompanion Software
Exit the SACompanion Application

Exit the SACompanion Application

The SACompanion **Exit** button closes the SACompanion application and returns you to the Windows desktop.

7

| | |
|--|------|
| Remote Operation Using SCPI Commands | 7-2 |
| Command-Set Prefix | 7-3 |
| Setting Up a Connection for SCPI Operation | 7-6 |
| Common SCPI Tablet Commands | 7-7 |
| SYSTEM Commands | 7-9 |
| SOURCE Commands | 7-13 |
| FETCH Commands | 7-14 |

Remote Operation

Remote Operation Using SCPI Commands

The Tablet supports remote operation with Standard Commands for Programmable Instruments (SCPI), a command language used to control electronic test and measurement instruments. SCPI commands are sent from a PC to a test instrument to configure the instrument, perform tests, and gather data. See *Setting Up a Connection for SCPI Operation*, page 7-6, for instructions on using SCPI.

The following types of SCPI commands are available for the Tablet:

:SYSTEM commands set up the basic Tablet configuration.

:SOURCE commands define power-configuration settings.

:FETCH commands retrieve current configuration settings.

In addition, several common commands are used to retrieve basic Tablet information. SCPI command descriptions begin on page 7-7.

Note: SCPI functionality is available only when you purchase Option 500 for your Tablet.

SCPI Command Syntax

This section describes the SCPI command format (shown below), and provides general information about issuing SCPI commands.

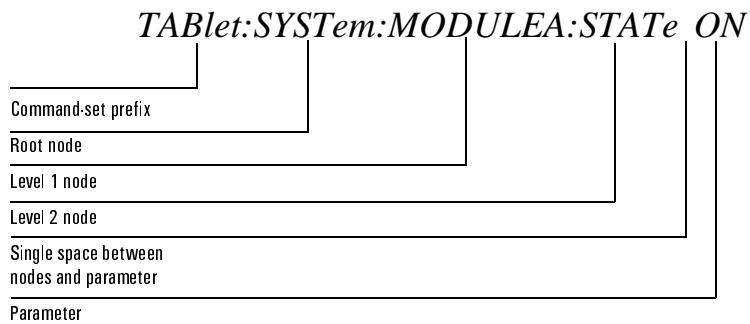

Command-Set Prefix

The command-set prefix indicates whether the issued SCPI command is for a Tablet or a plug-in module.

Tablet SCPI commands do not require a prefix; however, you can use the prefix **TABLEt** if you want. For example, both of the following commands perform the same task.

TABLEt:SYSTem:POWer:SHUTdown ON
SYSTem:POWer:SHUTdown ON

Root Nodes

SCPI commands consist of a *root node* and one or more lower-level nodes, followed by a parameter. Generally, each root and lower-level node is preceded by a colon (:). This helps the instrument correctly parse the command's component parts.

Long Form and Short Form

SCPI commands have both a long and short version (for example **:SOURCE** and **:SOUR**). The Tablet responds to either version, but will not respond to variations of either version.

This manual uses capital letters (uppercase) to show the short version of the command. Lowercase letters show the additional characters that make up the long version of the command.

The SCPI interface does not differentiate between uppercase and lowercase letters; only the long or short form of a command is valid.

SCPI Command Entry Format—Example command = “:SOURce”

| | Command Entry | |
|------------------|---------------|--------|
| Correct | :SOURCE | :sour |
| | :SOURce | :SOUR |
| Incorrect | :SOU | :sourc |

Using Parameters

Parameters provide a setting for the command (for example, ON or OFF). They follow the node commands and are listed in angle brackets (< >). Not all SCPI commands have parameters.

Multiple command parameters are separated by a vertical bar (|).

SCPI Command Separators

The following table lists the separators used in SCPI commands.

| SCPI Command Separators | | |
|---------------------------------------|---------------|-------------------------------------|
| To Separate... | Use... | Example |
| A command set prefix from a root node | Colon (:) | TABLEt:SYSTem:ERRor? |
| A root node from a lower level node | Colon (:) | SYSTem:VERSion? |
| Multiple commands entered in sequence | Semicolon (;) | SYST:AUTO:STATE ON;SYST:POW:SUSP ON |
| A parameter from a command | Space | SYSTem:COMMunicate:SERial:DATA 7 |

Sending Multiple Commands in a Command String

You can send multiple commands in the same command string. The commands execute one at a time, but this method saves time when you are entering many SCPI commands. Use a semicolon (;) to separate the commands.

Here's an example of a command string that contains more than one command:

```
SOURce:POWer:MODULEA ON; SYSTem:MODULEA:STATe ON
```

When the Tablet receives this command string, it executes both commands separately: first turning on power for the module installed in slot A, and then starting its GUI.

The number of commands you can include in a single string is limited only by the number of characters you can enter in the command line of your terminal-emulation package.

Note: A carriage return ends the command string.

Setting Up a Connection for SCPI Operation

This section provides information about how to set up a connection between the Tablet and a PC, and issue SCPI commands.

System Requirements

Following is a list of requirements for issuing SCPI commands.

- a desktop or laptop PC running Windows or MS-DOS operating system software
- a terminal-emulation package (such as HyperTerminal) on the PC
- an RS-232 null-modem cable (provided with N1617A)

Connection Instructions

Follow these steps to connect the Tablet to a PC, and start a SCPI session.

Note: Make sure that **Remote Enable** is selected in the Service Advisor Manager Setup screen, under the Local/Remote option (page 2-19).

1. Install the RS-232 (null-modem) cable between the Tablet's serial port and a comm port on the PC. Make sure both ports have the same communications settings.

If you need to change the Tablet's default settings (*115,200 baud, 8 data/1 stop bit, no parity*), use the **Serial Port** option under the Service Advisor Manager's Setup screen (see page 2-16). Refer to the PC documentation for information on changing PC comm settings.

2. Start the terminal-emulation program on the PC. This is where you will issue SCPI commands.

Press the **Enter** or **Return** key after entering each SCPI command or command string.

3. Issue the ***IDN ?** command to test the connection to the Tablet. If you receive identification information such as "N1610A Service Advisor Manager," you know the connection is valid.
4. Continue issuing SCPI commands at the command-line prompt. Command responses appear in the terminal-emulation window.

Common SCPI Tablet Commands

The following SCPI commands return information about the Tablet.

Tablet Information Commands

| Command | Description |
|-----------------|--|
| *IDN? | Returns the Service Advisor Manager software identification number. |
| SYSTem:ERRor? | Returns the status of the last command. (0 = pass; any negative number = fail, see table below) |
| SYSTem:VERSion? | Returns the version number of the Service Advisor Manager software. |

SCPI Return Codes

Each SCPI command returns a code that indicates whether the command was successful, or if an error occurred.

SCPI Return Codes

| Code | Meaning |
|-------------|--|
| 0 | Command executed successfully. |
| -100 | Command error. |
| -109 | Required parameter missing. |
| -112 | Command keyword too long. |
| -120 | Parameter value out-of-range. |
| -221 | Invalid mode setting for command. |
| -223 | Command line longer than 80 characters. |
| -350 | Error lost due to overflow in error queue. |

SYSTem Commands

SYSTem commands are equivalent to options in the Service Advisor Manager Setup tab. Use them to set up the Tablet configuration.

SYSTem:MODULEA:STATe <ON | OFF>

This command activates (ON) or deactivates (off) the GUI for the module in slot A.

Default: OFF

SYSTem:MODULEB:STATe <ON | OFF>

This command activates (ON) or deactivates (off) the GUI for the module in slot B.

Default: OFF

SYSTem:AUTOstart:STATe <ON | OFF>

This command enables (ON) or disables (off) the GUI auto-start feature. When ON, the GUI is automatically started when the Tablet is switched ON or the module is plugged in. When off, you must issue the command **SYSTem:MODULEx:STATe ON** to start the GUI.

Default: ON

SYSTem:POWer:SHUTdown <ON | OFF>

This command enables (ON) or disables (off) the Tablet's power shutdown feature. When ON, this feature automatically switches off power when you select **Shutdown** in the Service Advisor Manager toolbar.

Default: ON

Remote Operation

SYSTem Commands

SYSTem:POWer:SUSPend <ON | OFF>

This command enables (ON) or disables (off) the power-suspend feature for battery operation. When the feature is ON, power is switched off after three minutes of inactivity (that is, there are no keystrokes). *If you plan to run tests lasting longer than three minutes, be sure this feature is disabled.*

Default: OFF

Serial Communication Commands

Use the serial communication commands to configure settings for the Tablet's serial port.

Caution: Be careful when issuing these commands. If you reconfigure the Tablet's serial port settings so they no longer match the PC comm port settings, you'll have to reconfigure the settings, as follows:

- Use the GUI to reconfigure the Tablet settings (see *Working with the Service Advisor Manager*, page 2–10, and *Serial Port*, page 2–16).
- Use whatever procedures are appropriate to reconfigure the PC comm settings (see the PC documentation for instructions).

SYSTem:COMMunicate:SERial:BAUD
<1200 | 2400 | 9600 | 19200 | 38400 | 115200>

This command sets the baud-rate parameter.

Default: 115200

The following command sets the baud rate to 38,400.

```
SYST:COMM:SER:BAUD 38400
```

SYSTem:COMMunicate:SERial:DATA <7 | 8>

This command sets the data-bits parameter.

Default: 8

SYSTem:COMMunicate:SERial:STOP <1 | 2>

This command sets the stop-bits parameter.

Default: 1

Remote Operation

Serial Communication Commands

SYSTem:COMMunicate:SERial:PARity <EVEN | ODD | NONE>

This command sets the parity parameter.

Default: NONE

The following command configures odd parity.

SYST:COMM:SER:PAR odd

SOURce Commands

SOURce commands control power for the Tablet modules.

SOURce:POWer:MODULEA <ON | OFF>

This command turns power ON or off for the module in slot A.

Default: OFF

SOURce:POWer:MODULEB <ON | OFF>

This command turns power ON or off for the module in slot B.

Default: OFF

FETCh Commands

FETCh commands retrieve information about Tablet components and configuration settings.

FETCh Commands

| Command | Description |
|----------------------|---|
| FETCh:NAME:MODULEA? | Returns the name of the module in slot A. |
| FETCh:SWrev:MODULEA? | Returns the software revision of the module in slot A. |
| FETCh:HWrev:MODULEA? | Returns the hardware revision of the module in slot A. |
| FETCh:NAME:MODULEB? | Returns the name of the module in slot B. |
| FETCh:SWrev:MODULEB? | Returns the software revision of the module in slot B. |
| FETCh:HWrev:MODULEB? | Returns the hardware revision of the module in slot B. |
| FETCh:Osrev? | Returns the version number of the Tablet's operating system software. |
| FETCh:Swrev? | Returns the version number of the Service Advisor Manager software. |
| FETCh:Hwrev? | Returns the hardware revision of the Tablet. |
| FETCh:FLASh? | Returns the Tablet's FLASH memory size (in bytes). |
| FETCh:RAM? | Returns the Tablet's RAM size (in bytes). |
| FETCh:BATTery? | Returns the Tablet's remaining battery life (in seconds). |
| FETCh:NAME:PCMCia? | Returns the name of the PCMCIA card in the Tablet. |

8

Service Advisor Tablet (N1610A) Specifications 8-2

Ordering Information 8-3

CLEI Codes 8-4

Specifications

8-1

Specifications

Service Advisor Tablet (N1610A) Specifications

Service Advisor Tablet (N1610A) Specifications

The following table lists the specifications for the Tablet.

| Characteristic | Specification |
|--|--|
| General Operating Characteristics | |
| Operating system | Windows CE |
| Display | Color VGA (640 × 480); touch screen. |
| Connectors | |
| Type II PC-card slots (PCMCIA) | Wireline/wireless modems 10Base-T Ethernet NIC GP-IB (IEEE-488) interface Flash ROM cards |
| Parallel port | Printer connection |
| Serial ports | Serial connections to external devices |
| Physical Characteristics | |
| Size (W × H × D) | 11.1 × 8.0 × 3.5 inches (282 × 203 × 89 mm) |
| Weight | 5.4 pounds (2.45 kg) with battery 4.3 pounds (1.95 kg) without battery |
| Temperature | Operating: 0 to +45 °C (+32 to +113 °F) Storage: -20 to +70 °C (-4 to +158 °F) |
| Power | Available to plug-in modules: 10.5 watts Sources: NiMH rechargeable battery (8 hours operation) Vac power, through N1612A adapter: 90 – 264 V (autosensing); 50 – 60 Hz 12 Vdc vehicle power, through N1614A adapter |

Ordering Information

Contact your Agilent representative to purchase any of the following products and accessories.

N1610A Tablet Ordering Information

| Part Number | Product Description | | | | | | |
|-------------|---|--------|-------------|-----|--|-----|--------------------------|
| N1610A | Service Advisor Portable Test Tablet, includes: NiMH battery and internal battery charger, Service Advisor Companion software, Vac power adapter (N1612A) and power cord DB-9 to DB-9 serial null modem cable (8120-8845) | | | | | | |
| | <table border="1"> <thead> <tr> <th style="text-align: left;">Option</th> <th style="text-align: left;">Description</th> </tr> </thead> <tbody> <tr> <td>500</td> <td>Remote Services (for Tablet and modules)</td> </tr> <tr> <td>910</td> <td>Additional User's Manual</td> </tr> </tbody> </table> | Option | Description | 500 | Remote Services (for Tablet and modules) | 910 | Additional User's Manual |
| Option | Description | | | | | | |
| 500 | Remote Services (for Tablet and modules) | | | | | | |
| 910 | Additional User's Manual | | | | | | |
| N1611A | Additional NiMH battery (for N1610A) | | | | | | |
| N1612A | Universal Vac power adapter and power cord (select one): ABA (North America) ABB (European HPSA) ABU (UK) ABG (Australia) ACF (Japan) AKM (China) AKJ (Israel) ACD (Switzerland) | | | | | | |
| N1613A | External battery charger (for N1610A) | | | | | | |
| N1614A | 12 Vdc vehicle power adapter (for N1610A) | | | | | | |
| N1615A | Softside carrying case (for N1610A and accessories) | | | | | | |
| N1616A | Hard carrying case (for N1610A and accessories) | | | | | | |
| N1617A | Service Advisor Connectivity kit, includes: Service Advisor Companion software, DB-9 to DB-9 null-modem cable | | | | | | |
| N1618A | 56 k/V.90 Modem PC card | | | | | | |

Specifications

N1610A Tablet Ordering Information, continued

| Part Number | Product Description |
|-------------|--|
| N1620A | 10-BaseT Ethernet LAN PC card |
| N1621A | 10 Mb Compact Flash and PCMCIA adapter |
| N1625A | xDSL 2 MHz TMS Module (ANSI) |
| N1626A | xDSL 2 MHz TMS Module (ITU-T) |
| N1627A | Metallic Time Domain Reflectometer (TDR) Test Module |
| N1640A | ATM Cell Processor Test Module |
| N1645A | SONET/SDH Interface Module |
| N1660A | Dual DS1/O Module |

CLEI Codes

The following table lists the CLEI codes assigned to the Tablet.

CLEI Codes

Service Advisor Tablet (N1610A)

| | |
|-------------|------------|
| CLEI | TEDQADDJAA |
| CPR/OFC | 774277 |
| FRC | -7C |
| ECN | 010 |
| ECI/Barcode | 242226 |

Agilent Technologies Limited Warranty Statement

Agilent Product: N1610A Service Advisor Portable Test Tablet

Duration of Limited Warranty: Three years

1. Agilent warrants to you, the end-user customer, that Agilent hardware, accessories and supplies will be free from defects in materials and workmanship after the date of purchase, for the period specified above. If Agilent receives notice of such defects during the warranty period, Agilent will, at its option, either repair or replace products which prove to be defective. Replacement products may be either new or equivalent in performance to new.
2. Agilent warrants to you that Agilent software will not fail to execute its programming instructions after the date of purchase, for the period specified above, due to defects in material and workmanship when properly installed and used. If Agilent receives notice of such defects during the warranty period, Agilent will replace software which does not execute its programming instructions due to such defects.
3. Agilent does not warrant that the operation of Agilent products will be uninterrupted or error free. If Agilent is unable, within a reasonable time, to repair or replace any product to a condition as warranted, you will be entitled to a refund of the purchase price upon prompt return of the product.
4. Agilent products may contain remanufactured parts equivalent to new in performance or may have been subject to incidental use.
5. Warranty does not apply to defects resulting from (a) improper or inadequate maintenance or calibration, (b) software, interfacing, parts or supplies not supplied by Agilent, (c) unauthorized modification or misuse, (d) operation outside of the published environmental specifications for the product, or (e) improper site preparation or maintenance.
6. Agilent warrants that the Agilent Product described above will be able to accurately process date data (including, but not limited to, calculating, comparing, and sequencing) from, into, and between the twentieth and twenty-first centuries, and the years 1999 and 2000, including leap year calculations, when used in accordance with the Product documentation provided by Agilent (including any instructions for installing patches or upgrades), provided that all other products (e.g. hardware, software, firmware) used in combination with such Agilent Product(s) properly exchange date data with it. If the Specifications require that specific Agilent Products must perform as a system in accordance with the foregoing

Warranty & Service-1

Agilent Technologies Limited Warranty Statement

warranty, then that warranty will apply to those Agilent Products as a system, and Customer retains sole responsibility to ensure the Year 2000 readiness of its information technology and business environment. The duration of this warranty extends through January 31, 2001. To the extent permitted by local law, this warranty applies only to branded Agilent Products and not to products manufactured by others that may be sold or distributed by Agilent. The warranty in this paragraph 6) applies only to Agilent Products shipped after July 01, 1998. The remedies applicable to this paragraph 6) are those provided in paragraphs 1, 2, and 3.

7. Products purchased from Agilent outside the U.S. will receive the standard warranty in the country of purchase. If end user customer moves such Products to another country where Agilent has Support presence, then end user customer will receive the destination country standard warranty.
8. Products purchased in the U.S. based on the U.S. list prices will only receive standard warranty in the U.S., except for Products with a global warranty. A global warranty means that the Product will include the destination country's standard warranty in any country where the Product is moved provided that Agilent has Support presence in that country.
9. TO THE EXTENT ALLOWED BY LOCAL LAW, THE ABOVE WARRANTIES ARE EXCLUSIVE AND NO OTHER WARRANTY OR CONDITION, WHETHER WRITTEN OR ORAL, IS EXPRESSED OR IMPLIED AND AGILENT SPECIFICALLY DISCLAIMS ANY IMPLIED WARRANTIES OR CONDITIONS OF MERCHANTABILITY, SATISFACTORY QUALITY, AND FITNESS FOR A PARTICULAR PURPOSE. Some countries, states or provinces do not allow limitations on the duration of an implied warranty, so the above limitation or exclusion might not apply to you. This warranty gives you specific legal rights and you might also have other rights that vary from country to country, state to state, or province to province.
10. TO THE EXTENT ALLOWED BY LOCAL LAW, THE REMEDIES IN THIS WARRANTY STATEMENT ARE YOUR SOLE AND EXCLUSIVE REMEDIES. EXCEPT AS INDICATED ABOVE, IN NO EVENT WILL AGILENT OR ITS SUPPLIERS BE LIABLE FOR LOSS OF DATA OR FOR DIRECT, SPECIAL, INCIDENTAL, CONSEQUENTIAL (INCLUDING LOST PROFIT OR DATA), OR OTHER DAMAGE, WHETHER BASED IN CONTRACT, TORT, OR OTHERWISE. Some countries, states or provinces do not allow the exclusion or limitation of incidental or consequential damages, so the above limitation or exclusion may not apply to you.

THE WARRANTY TERMS CONTAINED IN THIS STATEMENT, EXCEPT TO THE EXTENT LAWFULLY PERMITTED, DO NOT EXCLUDE, RESTRICT OR MODIFY AND ARE IN ADDITION TO THE MANDATORY STATUTORY RIGHTS APPLICABLE TO THE SALE OF THIS PRODUCT TO YOU.

Warranty & Service-2

Calibration

This instrument must be calibrated only by authorized Agilent Technologies personnel. Unauthorized service or calibration will void the warranty.

The Agilent Technologies Tablet (N1610A) requires calibration every three years. To arrange for calibration, please contact Technical Support at 1-800-923-7522 or 978-266-3300.

Service

If your Tablet is not operating properly, carefully check all configuration parameters and connections. Improper selection of timing modes or drop channels, for example, can cause unexpected operation. Also check that the module is seated properly in the Service Advisor Tablet.

If you feel that your Tablet requires service, call Technical Support at 1-800-923-7522 or 978-266-3300. Trained personnel are available to help solve your problem or determine if the unit must be returned for repair.

Returning a Unit for Repair

If your Tablet must be returned, a Technical Support representative will assign a Return Material Authorization (RMA) number. No product will be accepted for service without an RMA number.

Ship the instrument to:

Repair Department
Agilent Technologies
Service Test Division
2 Robbins Road
Westford, MA 01886 USA

Be sure to mark the RMA number on the outside of the shipping container. In addition, be sure to include the following information:

- Model number (N1610A) and name (Service Advisor Tablet)
- Serial number
- Your name and phone number
- A written description of the problem
- Return “ship to” address
- Invoice address
- Payment information (if unit is out of warranty)

Glossary

> : Greater-than sign.

< : Less-than sign.

ac: Alternating current.

ADSL: Asymmetric Digital Subscriber Line.

AMI: Alternate Mark Inversion. A line coding scheme.

ANSI: American National Standards Institute.

ATU-C: ADSL termination unit–central office. The ADSL modem at the central-office end of the ADSL line.

ATU-R: ADSL termination unit–remote. The ADSL modem at the remote end of the ADSL line.

asynchronous: Not synchronized; not timed to an outside clock source.

attenuation: Signal loss.

bandwidth: A network's or channel's capacity to carry traffic.

bit: A basic unit of data. A bit can be set to either a zero or a one.

bit rate: (FTP) The speed at which bits are transferred over the network.

Bridged tap: Unconnected cables on a reconditioned line, a common cause of problems with digital services.

BW: See *bandwidth*.

byte: Eight bits. Usually refers to a particular location in a frame.

CCITT: Consultative Committee on International Telegraph and Telephone, now the International Telecommunications Union (ITU). The standards produced by this organization are called ITU-T Recommendations.

clock: The timing of, or timing source for, digital telecom equipment.

CO: Central Office.

CPE: Customer premises equipment.

dB: Decibel. Standard unit for transmission loss, gain, and relative power ratios.

dBdsx: Decibels relative to the DSX level.

dBm: Decibels relative to one milliwatt.

dBnC: Decibels relative to reference noise with C-message weighting.

dc: Direct current.

DCE: Data circuit-terminating equipment. Equipment that provides the interface between a DTE device and a transmission circuit (for example, a modem).

decimal: A base-10 numbering system in which the digits range from 0 to 9.

DNS: Domain Name System.

dotted decimal: The notation used for IP addresses, in the form *nnn.nnn.nnn.nnn* (where *nnn* is a

Glossary

decimal number from 0 to 255 that represents 8 bits of the address).

downlink: The ADSL circuit path used to transmit data from the central office (ATU-C) to the subscriber (ATU-R).

download: Moving information from one location to another (typically, between two network nodes).

downstream: See *downlink*.

DRS: Digital reference signal.

DS1: Digital signal level 1; 1.544 Mbps.

DTE: Data terminal equipment. Equipment that converts user information into data signals for transmission (for example, a PC).

DTMF: Dual Tone MultiFrequency.

EDD: Envelope delay distortion.

envelope: A group of frequencies used to simulate a data signal.

EPD: Echo Path Delay.

EPL: Echo Path Loss.

ERL: Echo Return Loss.

ESD: Electrostatic discharge. The discharge of static electricity, which has the potential to damage electronic circuitry.

FEXT: Far-end cross talk.

FLA: Frequency, Level, and Attenuation.

FTP: File Transfer Protocol.

gateway: A device (such as a router) that serves as an entryway into a network.

GUI: Graphical user interface.

HDSL: High-bit rate Digital Subscriber Line.

hexadecimal: A base-16 numbering system in which the digits range from 0 through F. A subscript "h" is used to denote a hexadecimal value (for example, 2A0F_h).

hop: A router in the path that data travels to reach a destination (remote) node.

HPC: Handheld PC (for example, the HP 620LX)

Hz: Hertz. Measure of frequency, one cycle per second.

IMD: Intermodulation Distortion.

IMPN: Impulse Noise.

IMPHT: Impulse Noise with Holding Tone.

IMPNBW: Impulse Noise (Wide-Band).

IP: Internet Protocol.

IP address: (TCP/IP protocol) A unique 32-bit address that identifies a network node. See also *dotted decimal*.

ISDN: Integrated Services Digital Network.

ISO: International Standards Organization.

ITU: International Telecommunications Union, formerly the Consultative Committee on International Telegraph and Telephone (CCITT). The standards produced by this organization are called ITU-T Recommendations.

jitter: Short-term variation in the phase of a digital signal (includes phase variation above 10 Hz).

Kb or Kbit: Kilobit. A thousand bits.

KB or Kbyte: Kilobyte. One thousand bytes.

Kbps: Kilobits per second.

kHz: Kilohertz. Measure of frequency, one thousand cycles per second.

LAN: Local area network.

LCD: Load Coil Detection.

LED: Light-emitting diode.

load coil: A device used to improve the quality of voice transmission, causes problems with digital services.

loopback: A state in which the transmit signal is reversed back as the receive signal, typically by a far-end network element.

mA: Milliampere. Measure of current, one thousandth of an ampere.

Mb or Mbit: Megabit. One million bits.

MB or Mbyte: Megabyte. One million bytes.

Mbps: Megabits per second.

MHz: Megahertz. Measure of frequency, one million cycles per second.

ms: Millisecond. One thousandth of a second.

NEXT: Near-end cross talk.

NHT: Noise with Holding Tone.

NIC: Network Interface Card. A type of PCMCIA card.

NiMH: Nickel Metal Hydride. A type of smart battery.

node: Any addressable device in the network, such as a host.

notch filter: A filter that removes a certain frequency from the signal, typically a holding tone.

NTG: Noise to Ground.

NWT: Noise with Tone.

OC: Optical carrier.

octet: Eight bits. Typically refers to a group of bits that spans more than one byte. Compare *byte*.

packet: A block of serial data, identified by a header and end byte.

P/AR: Peak-to-Average Ratio.

PI: Power influence. A test used to measure the amount of noise on each wire in a twisted pair.

PING: Packet InterNet Groper.

ppm: Parts per million.

POTS: Plain old telephone service.

PSD: Power Spectral Density.

QOS: Quality-Of-Service.

Glossary

RAM: Random access memory.

RMS: Root mean square. A type of detector used for TIMS measurements.

ROM: Read-only memory.

RX: (Receive) An input function.

SCPI: Standard Commands for Programmable Instruments.

SRL-lo: Singing Return Loss-low.

SRL-hi: Singing Return Loss-high.

S/TD: Signal-to-Noise and Total Distortion.

synchronous: Synchronized. Occurring at the same rate or period; sharing common timing with an outside timing source.

TCP: Transmission Control Protocol.

T1: See *DSL*.

TDR: Time Domain Reflectometer.

tester: An HP 1610A Service Advisor Portable Tablet running the IP Service Adviser software

timing: See *clock*.

TIMS: Transmission Impairment Measurement Set.

TLP: Transmission Level Point.

TTL: Transistor-to-transistor logic. A standard transmission level with a logic low of 0 volts and a logic high of 5 volts.

TX: (Transmit) An output signal or port.

uplink: The ADSL circuit path used to transmit data from the subscriber (ATU-R) to the central office (ATU-C).

upstream: See *uplink*.

V: Volt.

Vac: Volt, alternating current.

Vdc: Volt, direct current.

VF: Voice frequency.

V pk: Volt peak.

V p-p: Volt, peak-to-peak.

xDSL: Digital subscriber line.

Index

A

- accessories, Tablet 8-3
- ac power 2-2
- Agilent Options button 6-13
- auto-start module control 2-16

B

- battery power 2-3
 - charge remaining 2-11
 - information display 2-24
 - LED 1-3
 - recharging 2-4, 2-5
 - suspend function 2-16, 2-24
- button
 - Enter 1-3

C

- calibrating the touch screen 2-24
- charging the battery 2-4, 2-5
- CLEI codes 8-4
- commands. *See* SCPI commands
- Companion PC
 - connect to Tablet 6-3
- connectors
 - Tablet 1-4
- contrast
 - screen display 2-23
- copy files
 - from a PC 6-29
 - to a PC 6-31
- custom install 6-9

D

- data manager 6-29
 - delete files 6-32
- Data Mgr button 6-13
- date and time
 - setting 2-20
- dc power 2-2
- display screen 1-6
 - calibration 2-24
 - contrast 2-23
 - suspend 2-23
- DNS
 - see* Domain Name Services
- Domain Name Services
 - DNS lookup 4-6
 - screen 5-8
- download button
 - Software Upgrade screen 6-24
 - Tablet 6-23

E

- error codes
 - ping 5-3, 5-6
- Ethernet
 - configuring 6-16
 - installing NIC card 3-2
- Exit button 6-13
- exiting the GUI 1-7

F

- FETCh commands 7-14
- File menu 2-12
- flash memory
 - Tablet 2-11

G

- graphical user interface (GUI)
 - accessing Windows CE from 2-8
 - exiting 1-7
 - navigation basics 1-7
 - screen components 1-6
 - starting and stopping 2-8

H

- headphone jack 1-5

I

- * IDN ? command 7-7
- Info button 6-13, 6-19
- installing
 - modules 2-6
 - PC cards 2-7
- IP address 4-2
 - lookup 4-6, 5-8
- IP Service Advisor
 - configuring defaults 3-7
 - DNS lookup 4-6
 - ping screen 5-2
 - ping test 4-2
 - Setup Defaults screen 5-9
 - trace route test 4-4
 - user interface 3-3

J

- jacks
 - Tablet 1-5

L

- Launch Remote
 - button 6-13
- LEDs
 - front-panel 1-3
 - N1613A battery charger 2-5

M

- microphone jack 1-5
- module
 - auto-starting 2-16
 - closing software 6-27
 - installing 2-6
 - remotely launching 6-25
 - remote power ON 6-26
 - remove 6-28

N

- N1610A Service Advisor Tablet
 - See* Tablet
- N1612A ac power adapter 2-2
- N1613A battery charger 2-5
- N1614A 12 Vdc vehicle power adapter 2-2
- navigating the GUI 1-3, 1-7
- NICs, using 2-7

O

- OmniBook 800
 - connecting to Tablet 6-4
 - port settings 6-6

P

- parallel port 1-5
- PC cards 2-7
 - installation slot 1-4
 - type installed display 2-11
- ping
 - error messages 5-3
 - issuing 4-2
 - screen 5-2
- power 2-2, 2-3
 - configurations control 2-16
 - shutting off when idle 2-24
 - switch and LED 1-3

power mode indicator 3-5

power ON module 6-26

printer

connecting 1-5

manager screen 2-13

R

RAM

Tablet 2-11

README.TXT file 6-19

READY indicator on module 2-6

recharging the battery 2-4, 2-5

remote host name 4-2

remote operation

See also SCPI commands

S

S.A. Tablet. *See* Tablet

SACompanion

communications settings 6-14

description 6-2

exiting 6-34

install from CD 6-7–6-11

requirements 6-2

starting 6-12

toolbar 6-13

using for first time 6-12

SCPI

commands 7-2–7-14

command syntax 7-3–7-5

connection requirements 7-6

enabling use of 2-19

error codes 7-8

FETCH commands 7-14

issuing commands 7-3–7-6

parameter syntax 7-4

tools button 6-13, 6-33

SCPI commands

* IDN ? 7-7

SOURce:POWer:MODULEA 7-13

SOURce:POWer:MODULEB 7-13

SYSTem:AUTOstart:STATe 7-9

SYSTem:COMMunicate:SERial 7-11

SYSTem:ERRor ? 7-7

SYSTem:MODULEA:STATe 7-9

SYSTem:MODULEB:STATe 7-9

SYSTem:POWer:SHUTdown 7-9

SYSTem:POWer:SUSPend 7-10

SYSTem:VERSion ? 7-7

screen display 1-6

calibration 2-24

contrast 2-23

suspend 2-23

serial port 1-5

Service Advisor

upgrade 6-22

Service Advisor Manager

setup tab 2-16

starting 2-8, 3-2

Tablet Control screen 2-10

toolbar 2-12

using 2-10

version 2-11

setup button 6-13, 6-26

Shutdown

auto-power off 2-16

button 2-9

options 2-12

software revision levels

checking 6-19

SOURce:POWer:MODULEA command

7-13

SOURce:POWer:MODULEB command

7-13

speaker volume 2-23

starting and stopping the Tablet GUI

2-8

Index

- stop download button 6-24
- suspend
 - power feature 2-24
 - screen display 2-23
- SYSTEM:AUTOstart:STATe command 7-9
- SYSTEM:COMMunicate:SERial commands 7-11
- SYSTEM:ERRor ? command 7-7
- SYSTEM:MODULEA:STATe command 7-9
- SYSTEM:MODULEB:STATe command 7-9
- SYSTEM:POWer:SHUTdown command 7-9
- SYSTEM:POWer:SUSPend command 7-10
- SYSTEM:VERsion ? command 7-7

T

- Tablet 1-2–1-5
 - See also* SCPI commands
 - accessories 8-3
 - battery operation 2-3
 - buttons 1-3
 - CLEI codes 8-4
 - configuration 2-11–2-24
 - connecting to OmniBook 800 6-4
 - connectors 1-5
 - controls 1-3
 - download button 6-23
 - flash memory 2-11
 - GUI 1-6
 - hardware version 2-11
 - jacks 1-5
 - operating with SCPI 2-19
 - PC connections 2-7
 - power 2-2, 2-3
 - power configuration controls 2-16

- Tablet (*continued*)
 - power mode indicator 3-5
 - RAM 2-11
 - remote operation 2-19
 - SCPI operation 7-2
 - slots 1-4
 - specifications 8-2
 - starting and stopping 2-8
 - suspending operation when idle 2-24
 - toolbar 3-5
 - Windows CE 2-8
- Tablet properties button 6-23
- time and date
 - setting 2-20
- toolbar
 - Service Advisor Manager 2-12
- trace route
 - screen 5-5
 - test 4-4
- TTL
 - time to live 5-3
- typical install 6-9

U

- Upgrade
 - button 6-13
 - module 6-24
 - Service Advisor software 6-22

V

- vehicle power adapter (N1614A) 2-2
- volume
 - speaker 2-23

W

- Windows CE 2-8, 2-11



Artisan Technology Group is your source for quality new and certified-used/pre-owned equipment

- FAST SHIPPING AND DELIVERY
- TENS OF THOUSANDS OF IN-STOCK ITEMS
- EQUIPMENT DEMOS
- HUNDREDS OF MANUFACTURERS SUPPORTED
- LEASING/MONTHLY RENTALS
- ITAR CERTIFIED SECURE ASSET SOLUTIONS

SERVICE CENTER REPAIRS

Experienced engineers and technicians on staff at our full-service, in-house repair center

*InstraView*SM REMOTE INSPECTION

Remotely inspect equipment before purchasing with our interactive website at www.instraview.com ↗

WE BUY USED EQUIPMENT

Sell your excess, underutilized, and idle used equipment. We also offer credit for buy-backs and trade-ins. www.artisanng.com/WeBuyEquipment ↗

LOOKING FOR MORE INFORMATION?

Visit us on the web at www.artisanng.com ↗ for more information on price quotations, drivers, technical specifications, manuals, and documentation

Contact us: (888) 88-SOURCE | sales@artisanng.com | www.artisanng.com