

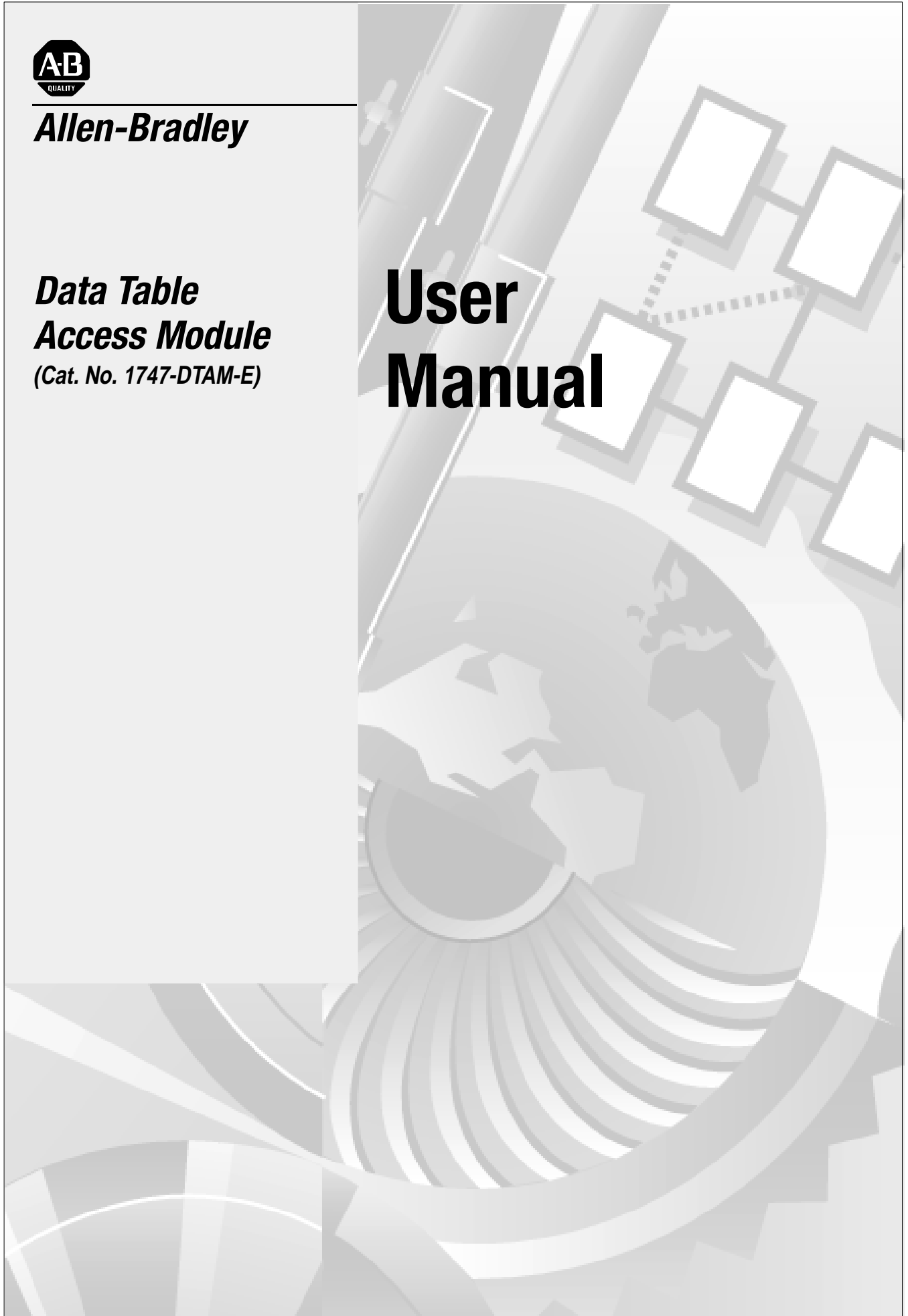

Allen-Bradley

***Data Table
Access Module
(Cat. No. 1747-DTAM-E)***

User Manual



Important User Information

Because of the variety of uses for the products described in this publication, those responsible for the application and use of this control equipment must satisfy themselves that all necessary steps have been taken to assure that each application and use meets all performance and safety requirements, including any applicable laws, regulations, codes and standards.

The illustrations, charts, sample programs and layout examples shown in this guide are intended solely for purposes of example. Since there are many variables and requirements associated with any particular installation, Allen-Bradley does not assume responsibility or liability (to include intellectual property liability) for actual use based upon the examples shown in this publication.

Allen-Bradley publication SGI-1.1, *Safety Guidelines for the Application, Installation and Maintenance of Solid-State Control* (available from your local Allen-Bradley office), describes some important differences between solid-state equipment and electromechanical devices that should be taken into consideration when applying products such as those described in this publication.

Reproduction of the contents of this copyrighted publication, in whole or part, without written permission of Allen-Bradley Company, Inc., is prohibited.

Throughout this manual we use notes to make you aware of safety considerations:



ATTENTION: Identifies information about practices or circumstances that can lead to personal injury or death, property damage or economic loss.

Attention statements help you to:

- identify a hazard
- avoid a hazard
- recognize the consequences

Important: Identifies information that is critical for successful application and understanding of the product.

PLC, PLC2, PLC3, and PLC5 are registered trademarks of Rockwell Automation. SLC, SLC500, PanelView, RediPANEL, and Dataliner are trademarks of Rockwell Automation.

IBM is a registered trademark of International Business Machines, Inc.

Summary of Changes

The information below summarizes the changes to this manual since the last printing.

To help you find new information and updated information in this release of the manual, we have included change bars as shown to the right of this paragraph.

New Information

The table below lists sections that document new features and provide additional information about existing features, and it shows where to find this new information.

For New Information On	See Chapter
Because users may employ different programming devices, specific references to Advanced Programming Software have been removed from this manual.	Preface – Related Documentation Table and/or Your Software User Manual Chapter 8 – Message Capability
Notice of Class I, Division 2, Groups A, B, C, D Hazardous Location Certification	Chapter 1 – Data Table Access Module Overview Appendix A – Specifications
An updated diagram showing the connection of a DTAM module to a DH485 network using a link coupler and an Advanced Interface Converter (1747-NET-AIC).	Chapter 2 – Installation and Power Up
An updated listing of MSG Instruction Error Codes	Chapter 9 – Troubleshooting

Table of Contents

Preface

Who Should Use this Manual	P-1
Purpose of this Manual	P-1
Contents of this Manual	P-2
Related Documentation	P-3
Common Techniques Used in this Manual	P-3
Allen-Bradley Support	P-4
Local Product Support	P-4
Technical Product Assistance	P-4
Your Questions or Comments on this Manual	P-4

Data Table Access Module Overview

Chapter 1

Module Overview	1-1
-----------------------	-----

Installation and Power Up

Chapter 2

European Union Directive Compliance	2-1
EMC Directive	2-1
Mounting the Module	2-1
Connecting Your Equipment	2-4
Module Configuration and Adjustments	2-6
Power-Up Sequence	2-8

Module Setup Procedure

Chapter 3

Keyboard Description	3-1
Factory Default Settings	3-2
Entering the Setup Mode	3-3
Selecting the Language	3-4
Selecting the Node Address	3-4
Setting the Baud Rate	3-5
Setting the Auto Attach Function	3-5
Backlighting the LCD	3-6
Setting the Monitor Override Function	3-6
Accepting Module Setup Parameters	3-7
Using the Module Reset	3-7

Attaching to a Processor

Chapter 4

Manual Attach Procedure	4-1
Auto Attach Procedure	4-2
Ready Attached Screen	4-3
Operating Mode Text	4-3
Backspace Function During Attach Procedure	4-3
Attaching to a Password Protected Processor	4-4

Monitoring and Modifying Data

Chapter 5

Operating Modes	5-1
Modify Mode	5-1
Monitor Mode.....	5-1
Monitor Override Feature	5-1
Logical Data File Addressing	5-3
Backspace Function During Data File Address Entry	5-4
Quick Access Addressing	5-5
Entering Data File Addresses	5-7
Entering Input and Output Addresses.....	5-7
Entering Bit Addresses	5-7
Entering Timer and Counter Addresses	5-7
Entering Control Register Addresses	5-8
Entering Integer Addresses.....	5-8
How to Change Displayed Data File Addresses	5-9
How to Display Higher and Lower Word Addresses.....	5-9
How to Display Different Word Addresses Within Elements.....	5-10
How to Display Different Control Bits Within Elements	5-11
How to Display Different Bit File Addresses	5-12
How to Change Data File Values	5-12
How to Change Word Values	5-12
How to Change the Sign of a Value	5-14
Backspace Function During Data File Value Entry	5-14
How to Change Bit Status at the Word Level	5-15
Cursor Right Function During Binary Data Entry.....	5-15
How to Change Bit Status at the Bit Level.....	5-16

Quick Recall Functions

Chapter 6

Quick Recall Function Overview	6-1
Defining Quick Recall Functions	6-1
Using Quick Recall Functions	6-2
Clearing Quick Recall Functions	6-3

Processor Control Functions

Chapter 7

Changing the Processor to Run Mode	7-1
Changing the Processor to Program Mode	7-2
Viewing Processor Faults	7-2
Clearing Processor Faults	7-3
Transferring Memory from EEPROM to RAM	7-4
Transferring Memory from RAM to EEPROM	7-5

Message Capability

Chapter 8

Message Overview	8-1
Programming the MSG Instruction	8-2
5/02 Control Block Configuration	8-2
5/03 Control Block Configuration	8-4
8-Word Message	8-6

16-Word Message	8-7
12-Word Message	8-8
13-Word Message	8-9
18-Word Message	8-10
1-Word Message	8-11
Application Example 1	8-12
Application Example 2	8-18

Troubleshooting

Chapter 9

Troubleshooting Module Problems Using the Communications LED	9-1
Troubleshooting Module Problems Using the LCD	9-3
Troubleshooting Communication Problems Using the LCD	9-4
Troubleshooting Function Problems Using the LCD	9-7
Troubleshooting MSG Instruction Error Codes	9-8
Troubleshooting Processor Faults Using the LCD	9-11

Specifications

Appendix A

Operating Power	A-1
Temperature and Humidity	A-1
General Characteristics	A-2

SLC 500 Data Files and Logical Addressing

Appendix B

Data Files	B-1
Data File Types	B-1
Address Structure	B-2
Data Files 0 and 1 - Outputs and Inputs	B-2
Data File 3 - Bit	B-5
Data File 4 - Timers	B-6
Data File 5 - Counters	B-7
Data File 6 - Control	B-8
Data File 7- Integer	B-9

Module Display Character Set

Appendix C

Display Character Table	C-1
-------------------------------	-----

Mounting Template

Appendix D

Using the Template	D-1
--------------------------	-----

Preface

Read this preface to familiarize yourself with the rest of the manual. This preface covers the following topics:

- who should use this manual
- the purpose of this manual
- common techniques used in this manual
- Allen-Bradley support

Who Should Use this Manual

Use this manual if you are responsible for designing, installing, programming, or troubleshooting control systems that use Allen-Bradley small logic controllers.

You should have a basic understanding of SLC 500 products. If you do not, contact your local Allen-Bradley representative for information on available training courses before using this product.

Purpose of this Manual

This manual is a learning and reference guide for the Data Table Access Module. It describes the procedures you use to access data file information, change operating modes, monitor and clear processor faults, and transfer memory with any SLC 500 family processor.

Contents of this Manual

Chapter	Title	Contents
	Preface	Describes the purpose, background, and scope of this manual. Also specifies the audience for whom this manual is intended.
1	Data Table Access Module Overview	Explains features and capabilities.
2	Installation and Powerup	Describes module installation, connections, and power up.
3	Module Setup Procedure	Gives descriptions and examples of module setup.
4	Attaching to a Processor	Provides instructions on how to initiate communications with a processor.
5	Monitoring and Modifying Data	Describes Monitor and Modify modes, addressing methods, and methods used to modify and monitor data.
6	Quick Recall Functions	Describes how to define, utilize, and clear user macros.
7	Processor Control Functions	Contains instructions on how to change processor modes, view and clear processor faults, and transfer RAM to and from EEPROM memory.
8	Message Capability	Describes module use as an operator interface using the message capabilities of the SLC 5/02 and 5/03 processors.
9	Troubleshooting	Provides instructions on solving common operating problems.
Appendix A	Specifications	Provides physical, electrical, environmental, and functional specifications for this module.
Appendix B	SLC 500 Data Files and Logical Addressing	Gives overview of SLC 500 Family processor data files and logical addressing.
Appendix C	Module Display Character Set	Provides conversion table showing ASCII characters in binary and hexadecimal format.
Appendix D	Mounting Template	Contains tear-out dimensional template for cutout and drilling dimensions.
	Quick Reference Chart	A tear-out pocket guide for DTAM procedures.

Related Documentation

The following documents contain additional information concerning Allen-Bradley SLC and PLC products. To obtain a copy, contact your local Allen-Bradley office or distributor.

For	Read this Document	Document Number
An overview of the SLC 500 family of products	SLC 500 System Overview	1747-2.30 ¹
A description on how to install and use your <i>Modular</i> SLC 500 programmable controller	Installation & Operation Manual for Modular Hardware Style Programmable Controllers	1747-6.2 ¹
A description on how to install and use your <i>Fixed</i> SLC 500 programmable controller	Installation & Operation Manual for Fixed Hardware Style Programmable Controllers	1747-6.21 ¹
A procedural manual for technical personnel who use APS to develop control applications	Rockwell Software Advanced Programming Software (APS) User Manual	9399-APSUM
A reference manual that contains status file data, instruction set, and troubleshooting information	SLC 500™ and MicroLogix™ 1000 Instruction Set Reference Manual	1747-6.15 ¹
An introduction to APS for first-time users, containing basic concepts but focusing on simple tasks and exercises, and allowing the reader to begin programming in the shortest time possible	Rockwell Software Getting Started Guide for APS	9399-APSQS
A procedural and reference manual for technical personnel who use the APS import/export utility to convert APS files to ASCII and conversely ASCII to APS files	Rockwell Software APS Import/Export User Manual	9399-APSIE
A programming reference guide to A.I. Series Software ladder logic for PLC-500	PLC-500 A.I. Series Ladder Logistics Processor Reference	9399-S5PR
A reference manual for technical personnel who use A.I. Series Programming Software	A.I. Series MicroLogix 1000 and PLC-500 Software Reference	9399-S5SR
A procedural and reference manual for technical personnel who use an HHT to develop control applications	Hand-Held Terminal User Manual	1747-NP002
An introduction to HHT for first-time users, focusing on simple tasks and exercises, and allowing the reader to begin programming in the shortest time possible	Getting Started Guide for HHT	1747-NM009
A complete listing of current Automation Group documentation, including ordering instructions. Also indicates whether the documents are available on CD-ROM or in multiple languages.	Automation Group Publication Index	SD499
A glossary of industrial automation terms and abbreviations	Allen-Bradley Industrial Automation Glossary	ICCG-7.1

1. Also available from the Automation Bookstore at <http://www.theautomationbookstore.com>.

Common Techniques Used in this Manual

The following conventions are used throughout this manual:

- Bulleted lists such as this one provide information, not procedural steps.
- Numbered lists provide sequential steps or hierarchical information.
- *Italic* type is used for emphasis.
- Text in **this font** indicates words or phrases you should type.

- Key names match the names shown and appear in bold, capital letters within brackets (for example, [**ENTER**]).
- The Data Table Access Module displays data and messages like this:

RDY>	1	RHALT
5/02		01234567

- The error symbol displays on the LCD when you attempt an illegal entry.



- The Data Table Access Module is called the module or DTAM.

Allen-Bradley Support

Allen-Bradley offers support services worldwide, with over 75 Sales/Support Offices, 512 authorized Distributors and 260 authorized Systems Integrators located throughout the United States alone, plus Allen-Bradley representatives in every major country in the world.

Local Product Support

Contact your local Allen-Bradley representative for:

- sales and order support
- product technical training
- warranty support
- support service agreements

Technical Product Assistance

If you need to contact Allen-Bradley for technical assistance, please review the information in chapter 9, *Troubleshooting*. Then call your local Allen-Bradley representative.

Your Questions or Comments on this Manual

If you have any suggestions for how this manual could be made more useful to you, please send us your ideas on the enclosed reply card.

If you find a problem with this manual, please notify us of it on the enclosed Publication Problem Report.

Data Table Access Module Overview

This chapter describes features and capabilities of the Data Table Access Module.

Module Overview

The Data Table Access Module (Catalog Number 1747-DTAM-E) is a plant floor device that allows you to access data file information, change operating modes, monitor and clear processor faults, and transfer memory with any SLC 500 family processor.

Important: The DTAM module does not support the floating point, string, and ASCII data values that can be used with SLC 5/03™ OS301 and later processors.

- Data can be monitored or modified in any SLC 500 family processor.
- Ten Quick Recall Functions are provided to assign frequently monitored and/or modified data file addresses to a simplified function key sequence.
- Processor operating modes can be changed between Run mode and Halt mode. (For SLC 5/03 processors, the keyswitch must be in the REM position before the mode can be changed.)
- Processor faults can be viewed and cleared.
- Memory can be transferred between CPU RAM and CPU EEPROM.
- Two operational modes are provided: **Monitor** and **Modify**. These modes are enabled or disabled by a factory-installed jumper or by a user-supplied security key switch.
- The **Monitor Override** feature allows you to modify data at specified addresses while in the **Monitor** mode.
- The Auto Attach function initiates processor communications.
- Prompts can be displayed in six, user-selectable languages: English, French, German, Italian, Spanish, and Japanese.
- Shorthand addressing provides easier access to default data files.
- The module can be used as a point-to-point interface to a SLC family processor or as a network device on a DH485 Network.
- The module can be used as an operator interface to display messages from SLC processors, such as the SLC 5/02 processor, on a DH485 Network.
- The module is UL-Listed, CSA-Certified and meets NEMA Type 12 and 13 enclosure applications.

- Class I, Division 2, Groups A, B, C, D, Hazardous Location Certification
- A bi-color LED indicates operational mode and the status of certain fault and communication conditions.
- The keyboard is a 19-key, sealed membrane keypad with tactile feedback.
- The data display is a 16-character x 2-line, dot-matrix, backlit LCD with contrast control.
- A single cable is provided for power and communications.
- Module configuration parameters are stored in nonvolatile memory.

Installation and Power Up

Read this chapter before installing the Data Table Access Module. It describes the procedures for:

- mounting the module
- connecting the module to your system
- module configuration and adjustments
- powering up the module

European Union Directive Compliance

If this product has the CE mark, it is approved for installation within the European Union and EEA regions. It has been designed and tested to meet the following directives.

EMC Directive

This product is tested to meet Council Directive 89/336/EEC Electromagnetic Compatibility (EMC) and the following standards, in whole or in part, documented in a technical construction file:

- EN50081-2
EMC – Generic Emission Standard, Part 2 – Industrial Environment
- EN50082-2
EMC – Generic Immunity Standard, Part 2 – Industrial Environment

This product is intended for use in an industrial environment.

Mounting the Module

The module is designed for mounting in a cutout on the door of an enclosure. The cutout and drilling dimensions for the module are shown on the following page. We have also included a full-size tear-out mounting template (appendix D) for your convenience.

When locating the cutout on the enclosure door:

- Provide 139.7 mm (5.5 in) clearance behind the enclosure door and 50.8 mm (2.0 in) electrical clearance above and below the module housing.



ATTENTION: To keep the module temperature within the specified range, enclosure temperature must be between 0 to 55° (32 to 131° F).

- Before drilling in the enclosure door, all power to the enclosure must be disconnected. Make sure the drill bit does not contact equipment and cause damage.



ATTENTION: The module has ventilation holes on the top and bottom of the back cover. If you make additional holes in the enclosure, cover the module ventilation holes to protect against metal shavings entering the module housing.

- Do not remove top label until after installation.
- A strain relief tab on the back of the module helps reduce stress on the interconnect cable when the door is opened. Once the module is installed, insert the cable under the tab and bend the tab downward to secure the cable.
- The module has a .8 Nm (7.0 in-lb) mounting torque.
- Insure that the module is grounded. If the DTAM is mounted to a non-conductive surface, attach a #8 AWG wire from the DTAM grounding screw to the SLC chassis.

Prepare a cutout for your enclosure door using the measurements shown below. See the template in Appendix D.

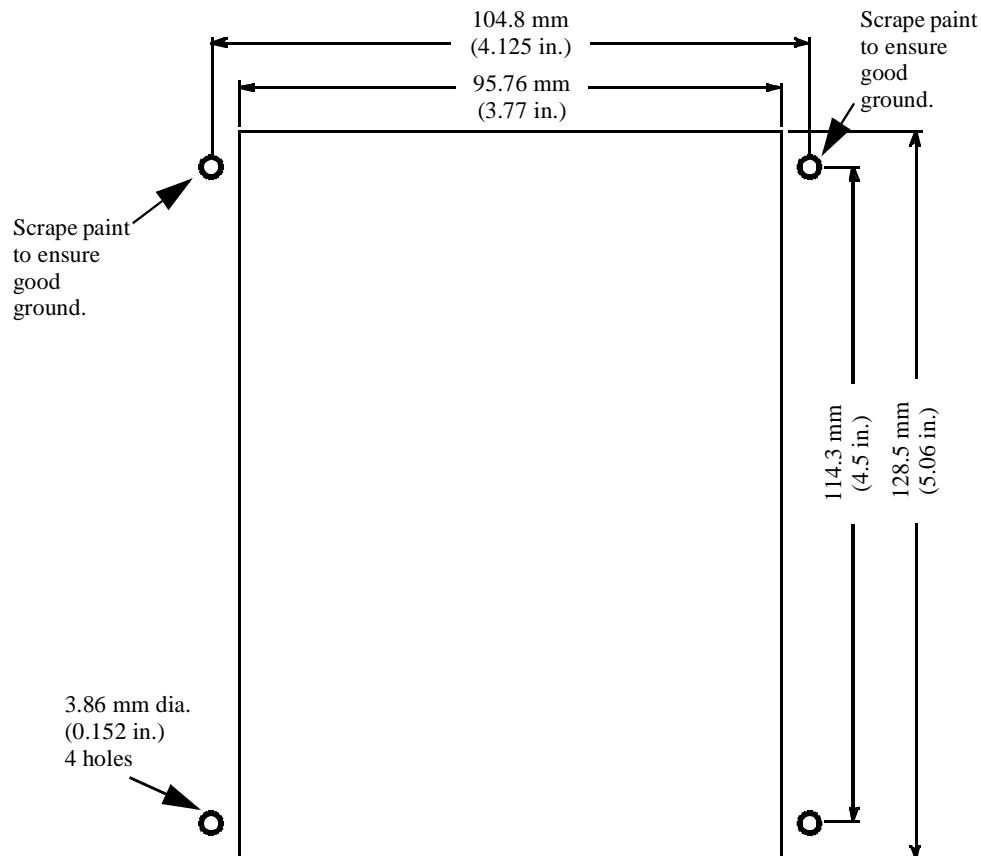

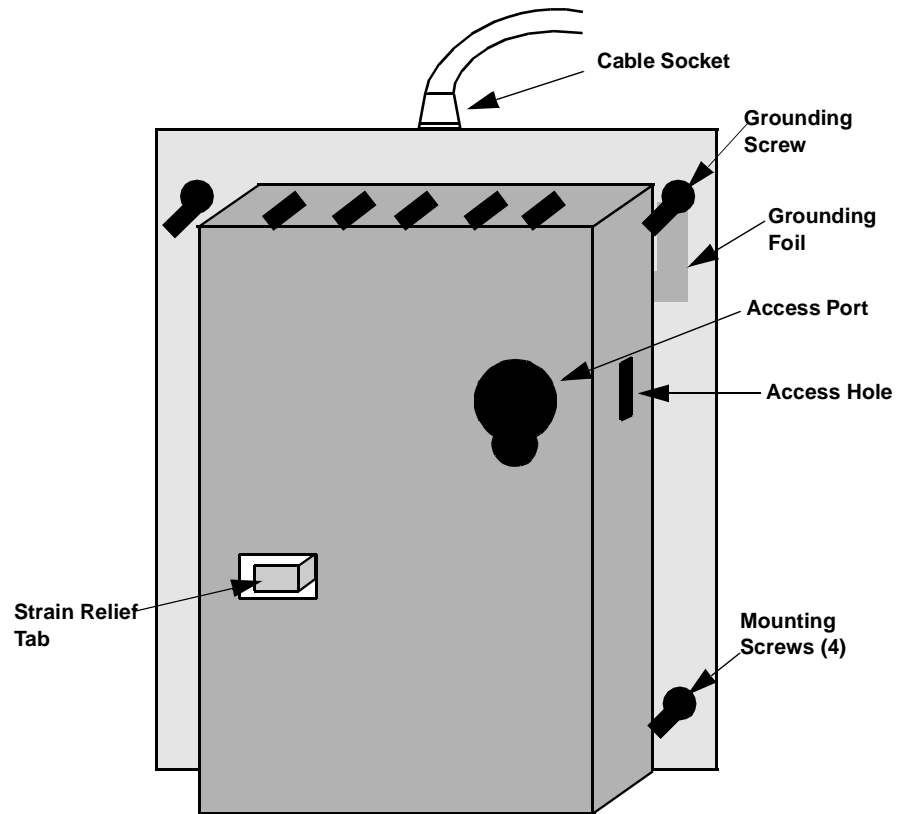
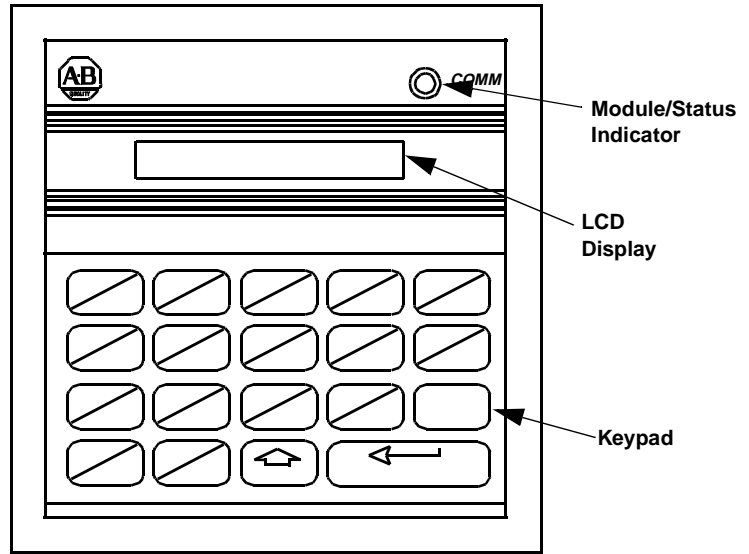

Connecting Your Equipment

Connect the module to your system as shown below:

Point-to-Point Connection to a SLC 500 Family Processor

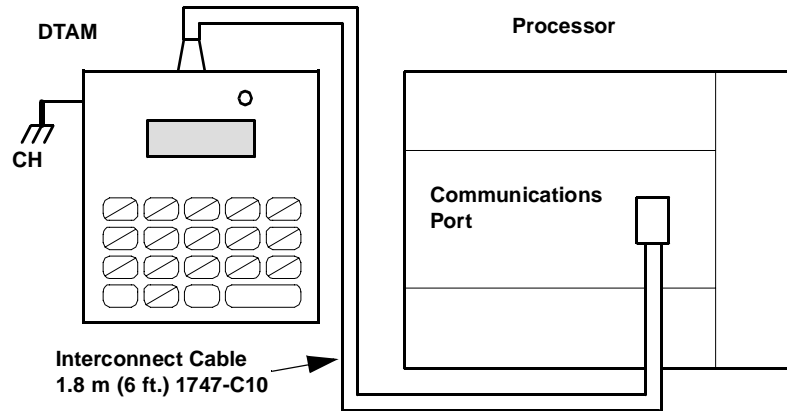

Connection to a DH485 Network

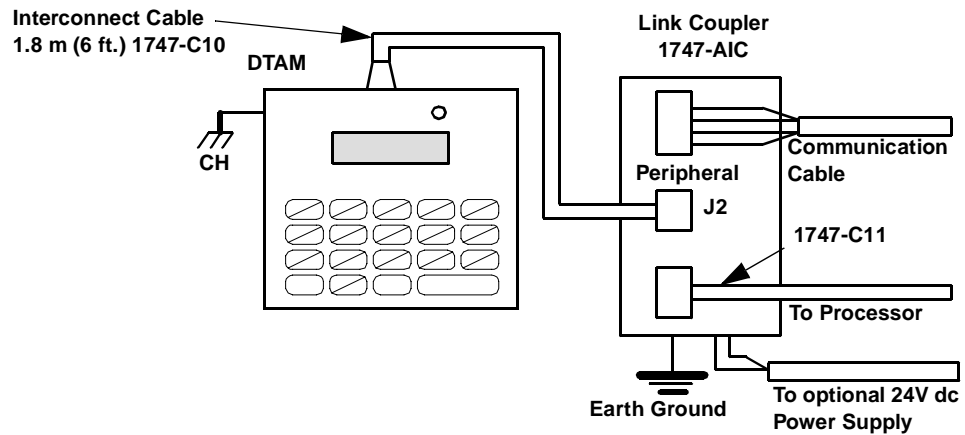

You can connect the DTAM module to an SLC 5/04 or later processor using either of the following methods.

Connection to a DH485 Network Using an Interface Module

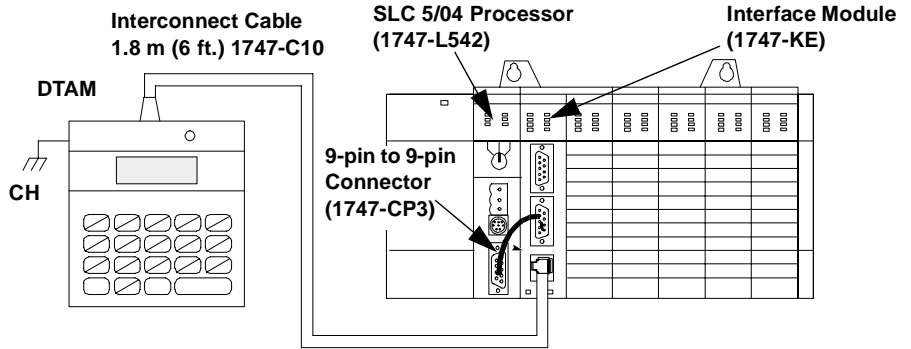

Connection to a DH485 Network Using Link Couplers

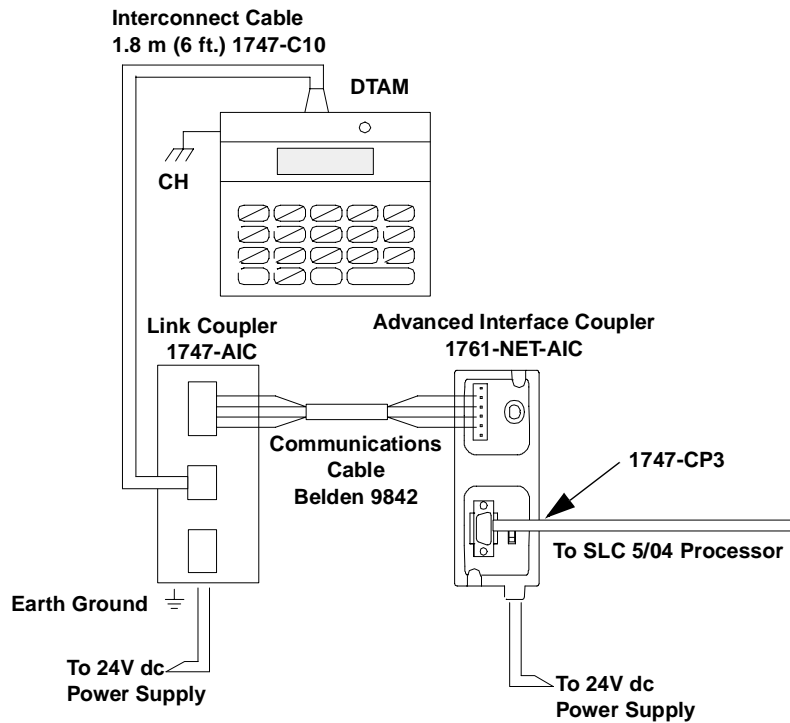

ATTENTION: The DTAM module end of the interconnect cable has pins that carry 24V dc. Disconnect the cable at the processor or link coupler to guard against connector short circuits and possible damage to the processor.

Module Configuration and Adjustments

The module's access port and access hole allow you to adjust the LCD contrast and select the operational mode. Refer to chapter 5 to determine which mode to select, then return to this section to make the physical setting.

The module is shipped from the factory with the jumper installed between terminals 1 and 2 to configure the module for the **Modify** operational mode.

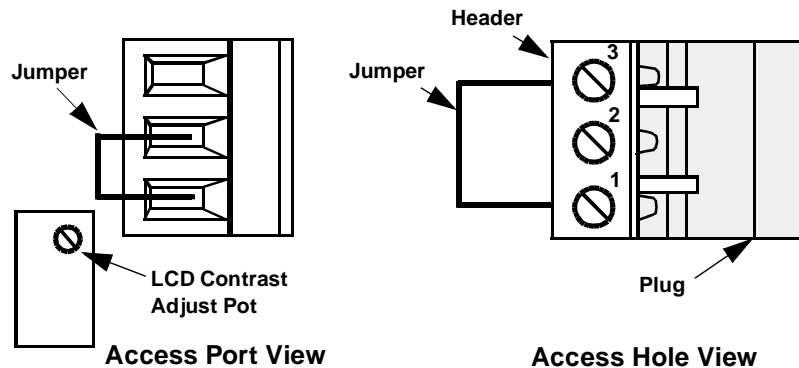

To configure the module for the **Monitor** mode, either connect the jumper between terminals 1 and 3 (leaving the jumper installed in the module) or completely remove the jumper. You may either leave the header in place and make the connection via the access port and access hole, or temporarily remove the header from the module by pulling it off of the plug. If you choose the latter method, return the header to the plug once the connection is made.

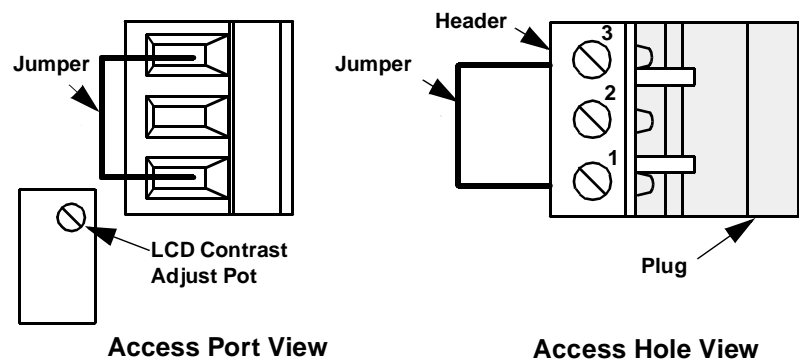

The jumper may be removed and an externally mounted user-supplied key switch connected.

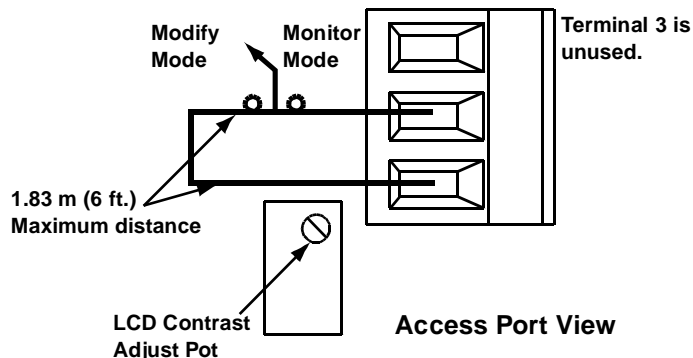

ATTENTION: To avoid damaging the module, when you wire an external keyswitch for mode control, use an isolated switching device. Do not apply power to the terminals.

ATTENTION: To avoid damaging the module, when you change the mode select jumper, disconnect power from the module. Move the top lead of the jumper between terminals 2 and 3. Always leave the lead attached to the bottom terminal (terminal 1) connected.

Important: After you have set up the module for your application, to prevent unauthorized access to data files, connect the jumper for the Monitor mode or wire the key switch as shown .

Power-Up Sequence

When the module is plugged into a processor or link coupler for the first time, the following sequence occurs:

1. The Communications LED illuminates solid red.
2. The module performs diagnostic self tests.
3. When the tests are complete, the Communications LED turns off, and the LCD displays:

A rectangular box representing an LCD display with the text "Enter Network Working . . ." inside.

If the module fails any of the self diagnostic tests, refer to chapter 9, *Troubleshooting*, for a list of error and fault codes.

4. The Communications LED flashes green, and the LCD displays:

A rectangular box representing an LCD display with the text "RDY>" inside.

5. After a successful power-up, the display shows the ready prompt. You can now perform any of the following functions:
 - Change the Module Setup. Refer to chapter 3, *Module Setup Procedure*.
 - Initiate communications with a SLC 500 family processor. Refer to chapter 4, *Attaching to a Processor*.
 - Clear an existing Quick Recall Function. Refer to chapter 6, *Quick Recall Functions*.
 - Observe and respond to a displayed message. Refer to chapter 8, *Message Capability*.

Module Setup Procedure

This chapter describes the setup procedures for configuring the operation of the module for specific applications. The topics covered are:

- language for the module display
- module node address
- module baud rate
- Auto Attach function
- LCD backlighting
- Monitor Override function
- module reset function

Keyboard Description

The keyboard is shown below. Details about individual key functions are described at the point of use in this manual.

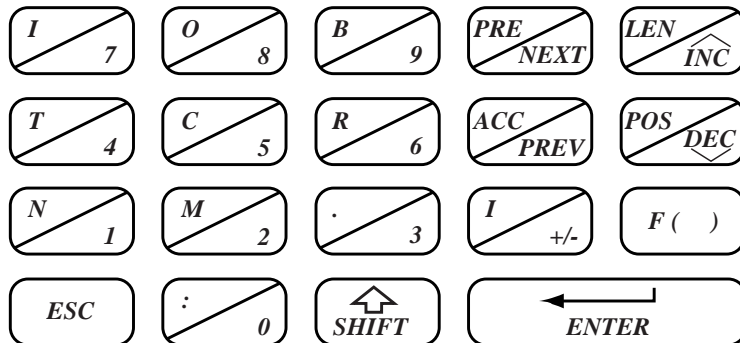

Key	Explanation
0 - 9	Numeric Keys
I	Input Image Data File
O	Output Image Data File
B	Bit Data File
T	Timer Data File
C	Counter Data File
R	Control Data File
N	Integer Data File
M	Reserved for Future Use

Key	Explanation
:	Data File Addressing Element Delimiter
.	Data File Addressing Word Delimiter
/	Data File Addressing Bit Delimiter
PRE	Timer/Counter Preset Word
ACC	Timer/Counter Accumulator Word
LEN	Control Register File Length Word
POS	Control Register Pointer Position Word
+/-	Positive/Negative Signed Integer
NEXT	Increment to Next Logical Address
PREV	Decrement to Previous Logical Address
INC	Increment Data Value or Control Bit
DEC	Decrement Data Value or Control Bit
F()	Function Key
ESC	Escape Key
SHIFT	Shift to Upper Case
ENTER	Enter Desired Parameter

Factory Default Settings

The module is shipped from the factory with the following default settings:

Feature	Default Setting
Language	English
DTAM Node Address	0
Baud Rate	19200
Auto Attach	Off
LCD Backlighting	On
Monitor Override	Off

Entering the Setup Mode

To change the Setup configuration, the module *must* be in the **Modify** mode. This is indicated by the flashing green Communications LED.

To review the Setup configuration, the module *must* be in the **Modify** mode. Press the [ENTER] key repeatedly until the procedure is complete.

After the module is powered up and the self diagnostics are completed, the LCD displays the Ready Unattached screen:



RDY>

To enter the Setup mode:

Press [7] [INC] simultaneously, and hold until the display shows:



Modify Setup
Confirm?

This display prompts you to confirm:

- If you want to initiate the setup procedure:
Press [ENTER] .
- If you want to return to the previous display:
Press [ESC] .

When the setup mode has been initiated, the Communications LED turns off.

Important: Once you initiated the setup procedure, only the [INC], [DEC] and [ENTER] keys are functional.

If the unit disconnects, a power failure occurs, or the module is switched from **Modify** to **Monitor** mode while in the setup procedure, no new parameters are saved.

Selecting the Language

You can configure the module to display all prompts and data in one of six languages. The available languages are: English, Spanish, Japanese, Italian, German and French. The default language displayed is English:



Select Language
ENGLISH

- To change the language displayed:
Press [**INC**] or [**DEC**] .
- To accept the displayed language:
Press [**ENTER**] .

Once you have selected a language, the module immediately begins to display in that language.

Selecting the Node Address

The node address is the communications identifier on the DH485 network for this module. Valid node addresses range from 0 through 31. The default node address displayed is 0.

Important: Care must be taken when selecting a node address. Do not duplicate the address of a processor or another device on the DH485 network.



Select DTAM Addr
0

- To change the node address:
Press [**INC**] or [**DEC**] .
- To accept the displayed address:
Press [**ENTER**] .

Setting the Baud Rate

This is the communications rate for the module. Available baud rates are: 1200, 2400, 9600 and 19200 baud. The default baud rate displayed is 19200.

Important: All devices on the DH485 network, including the module, must be set to the same baud rate.

Select Baud Rate
19200

- To scroll through the available baud rates:
Press [**INC**] or [**DEC**].
- To accept the displayed baud rate:
Press [**ENTER**].

Setting the Auto Attach Function

This selection determines how the module attaches to a processor. The default selection is **Off**.

When the function is set to **Off**, you are required to manually attach to a processor each time the module is powered up.

When the function is set to **On**, the module attempts to attach to the address of the last processor it was logically attached to or to the default node address of one.

Set Auto Attach
OFF

- To toggle between On and Off:
Press [**INC**] or [**DEC**].
- To accept the setting:
Press [**ENTER**].

Backlighting the LCD

This selection controls the illumination for the LCD. The default selection is **On**:

Set Backlighting
ON

- To toggle between On and Off:
Press **[INC]** or **[DEC]**.
- To accept the setting:
Press **[ENTER]**.

Setting the Monitor Override Function

The Monitor Override feature allows you to write to selected data file addresses while in the **Monitor** mode. Refer to chapter 5, *Monitoring and Modifying Data* and chapter 6, *Quick Recall Functions*. The default selection is **Off**:

Monitor Override
OFF

- To toggle between On and Off:
Press **[INC]** or **[DEC]**.
- To accept the setting:
Press **[ENTER]**.

Accepting Module Setup Parameters

If you accept the new configuration, the parameters are written to the module's nonvolatile memory. If you reject the new parameters, the previous setup configuration remains unchanged.

**Accept Setup
Confirm?**

- To accept the configuration:
Press [ENTER].
- To reject the configuration:
Press [ESC].

The module then performs a reset and self test. Upon completion, the LCD displays one of the two Ready screens. Refer to chapter 4, *Attaching to a Processor*, for a description of these displays.

Using the Module Reset

The module reset key sequence is available at any time and during any function sequence. Use it when a nonrecoverable fault condition error code is displayed or when the module appears to be nonfunctional. Refer to chapter 9, *Troubleshooting*, for fault conditions and error codes.

To reset the module:

Press [7] [8] [ENTER] simultaneously and hold until this message displays:

**DTAM Reset
In Progress**

This reset message continues to display during the reset procedure and the diagnostic test which follows. Upon completion, one of the Ready screens displays.

Attaching to a Processor

Read this chapter before initiating communications between the module and a SLC 500 family processor. It describes:

- Manual Attach procedure
- Auto Attach procedure
- Ready Attached screen
- Backspace Function during attach procedure
- attaching to a password-protected processor

Manual Attach Procedure

After the module is powered up and the setup parameters are configured, you are ready to attach to the desired processor to initiate communications.

You may perform the attach procedure with the module in either **Monitor** or **Modify** mode. Refer to chapter 5, *Monitoring and Modifying Data*, for descriptions of these modes.

If the module is configured with the Auto Attach feature set to **Off**:

1. At power up, the display shows the Ready Unattached screen:

A rectangular box with a black border containing the text "RDY>" in a monospaced font.

2. To attach to a processor node address:

Press [F ()] [SHIFT].

3. Notice the symbol to the right of RDY has changed to indicate a shifted key function:

A rectangular box with a black border containing the text "RDY^" in a monospaced font.

4. To Continue:

Press [I].

5. The module displays the attach to CPU screen. Asterisks display in the lower right-hand corner if the module was not previously attached to a processor or if the last processor it was attached to is no longer active. If a number is displayed in the lower right-hand corner, it is the node address of the processor to which the module was previously attached.

A rectangular box with a black border containing the text "Attach to CPU?" in a monospaced font.

**

6. To change the node address:
 - Scroll through the list of active node addresses attached to the network. Press [**INC**] or [**DEC**].
 - Use the numeric keys to enter a value from 0 through 31.
7. Once the appropriate node address is displayed:
Press [**ENTER**].
8. The module displays the Ready Attached screen:

```
RDY>    4    RRUN
5/02    4444
```

If the processor you are attaching to is password-protected, refer to the section on attaching to a password-protected processor on page 4-4.

Auto Attach Procedure

If the module is configured with the Auto Attach feature set to **On**:

1. At power up, the module displays:

```
Attach to CPU?
WORKING . . . .
```

2. When the module completes the attach procedure, the display shows the Ready Attached screen:

```
RDY>    4    RRUN
5/02    4444
```

If the module has not been previously attached to a processor or if the last processor it was attached to is no longer active, the display shows:

```
Attach to CPU?
**
```

1. To change the node address:
 - Press [**INC**] or [**DEC**] to scroll through the list of active node addresses attached to the network.
 - Use the numeric keys to enter a value from 0 through 31.
2. Once the appropriate node address is displayed:
Press [**ENTER**].

If the processor you are attaching to is password-protected, refer to the section on attaching to a password-protected processor on page 4-4.

Ready Attached Screen

The Ready Attached screen displays the ready prompt, processor node address, and processor operating mode on the top line, and the processor type and program name on the bottom line:

```
RDY>   4   RRUN
5/02   4444
```

Operating Mode Text

The text displayed in the Ready Attached screen depends on the processor mode and type, as summarized in the table below.

Processor Mode	Operating Mode Text	
	SLC 500, SLC 5/01™ and SLC 5/02™ Processors and SLC 5/03 and SLC 5/04 processors with Keyswitch in REM	SLC 5/03 or later processors with Keyswitch Not in REM
Run	RRUN	RUN
Program	RHALT	HALT
Test	RTEST	HALT
Fault	FAULT	FAULT

Backspace Function During Attach Procedure

If you incorrectly entered the node address during the Attach procedure (and have not pressed [ENTER] yet), you can use the Backspace Function to delete characters from right to left, and then re-type the value. Backspacing to the beginning of the string (leftmost character) will in most cases return the default value. The exception is during password entry.

There are two ways to implement the Backspace Function:

- *Single Backspace* - Press and release the [SHIFT] key, then press and release the [ESC] key.
- *Multiple Backspace* - Press and hold the [SHIFT] key while repeatedly pressing the [ESC] key.

The example below shows a default node address of 15.

```
Attach to CPU?
15
```

If you press 3 then 0, the node address changes to 30, as shown below.

```
Attach to CPU?
30
```

If you press and release the **[SHIFT]** key, then press and release the **[ESC]** key, the display appears as:

```
Attach to CPU?
                3
```

To restore the default value of 15, press and release the **[SHIFT]** key, then press and release the **[ESC]** key.

Attaching to a Password Protected Processor

In either of the previous procedures, if the processor you are attaching to is password-protected. The module displays:

```
Enter Password?
                ■
```

1. Use the numeric keys to enter the password.
2. As the password keys are pressed, the module displays asterisks in the lower right hand corner.

Important: During password entry, if you backspace to the beginning of the password (using **[SHIFT] [ESC]**), your password entry is invalid. the following message is displayed:

```
RDY>
Function Failed
```

3. When the password is complete:
Press **[ENTER]**.
4. When the password is accepted, the Ready Attached screen displays:

```
RDY>      4      RRUN
5/02      4444
```

If any variations of the above procedures occur, refer to chapter 9, *Troubleshooting*.

5. After successfully attaching to a processor, you can now:
 - Change the module setup. Refer to chapter 3, *Module Setup Procedure*.
 - Clear an existing Quick Recall Function. Refer to chapter 6, *Quick Recall Functions*.
 - Observe and respond to a displayed message. Refer to chapter 8, *Message Capability*.

Monitoring and Modifying Data

This chapter describes:

- operating modes
- logical data file addressing
- Backspace Function during data file address entry
- quick access addressing
- entering data file addresses
- changing displayed data file addresses
- changing data file values

Operating Modes

The module has two operational modes, **Modify** and **Monitor**. A **Monitor Override** feature is also provided.

Modify Mode

The module is shipped from the factory configured for the **Modify** mode. This mode allows access to all features available in the module. Refer to chapter 2, *Installation and Power Up*, for details on the **Modify** mode configuration.

Monitor Mode

When the module is configured for the **Monitor** mode, you are allowed to display values contained in data file words. Alteration of data within the processor data files is prohibited. This mode of operation is provided to prevent unauthorized access to certain processor functions. Refer to chapter 2, *Installation and Power Up*, for details on configuring the unit for the **Monitor** mode.

Monitor Override Feature

When configured for the **Monitor** mode, a **Monitor Override** feature is provided to allow data modification of up to ten user-defined data file addresses using the Quick Recall Functions. Refer to chapter 3 for details on how to use the module setup procedure to configure this feature. Refer to chapter 6 for a description of the Quick Recall Functions.

See the chart below for the functions you may perform in each mode:

Operation	Monitor Mode	Modify Mode
Module Setup	No	Yes
Monitor Data File Address	Yes	Yes
Modify Data File Address	No ¹	Yes ²
Change Processor Mode	No	Yes
Transfer EEPROM Memory to RAM	No	Yes
Transfer RAM Memory to EEPROM	No	Yes
Define a Quick Recall Function	No	Yes
Recall a Quick Recall Function	Yes	Yes
Clear a Quick Recall Function	No	Yes
Attach to a Processor	Yes	Yes
View a Processor Fault	Yes	Yes
Clear a Processor Fault	No	Yes
Receive a Message	Yes	Yes
Respond to a Message	Yes	Yes

1. Up to 10 user-defined addresses may be modified using the Monitor Override feature.
2. Input and Output Image Table words are always view only. In 5/02 and 5/03 processors, data files may have additional file protection preventing the DTAM from changing data.

The communications LED on the module changes according to the operational mode selected, as shown below:

LED	DTAM Operating Mode
Flashing Green	Modify Mode
Flashing Green	Data being entered using the Monitor Override feature
Solid Green	Monitor Mode

For additional information regarding the LED functions, refer to chapter 9, *Troubleshooting*.

Logical Data File Addressing

SLC 500 family logical addressing can be used with the module to access all data files except the status file (S2). You may access any valid address in the attached processor.

1. For example, to access T10:100.ACC you would use the following key sequence:

Press [SHIFT] [T] [1] [0] [SHIFT] [:] [1] [0] [0] [ACC] [ENTER].

As the address is being entered, the address will be displayed in the lower left-hand corner of the LCD.

2. When the [ENTER] key is pressed, the display shows the logical address on the top line and its associated value in the lower right-hand corner:

T10:100.ACC	999
-------------	-----

Important: Once you press [SHIFT] [T], [C] or [R], it is not necessary to press the [SHIFT] key for [PRE], [ACC], [LEN] or [POS].

1. To logically address to the bit level for B3:2/9, use the following key sequence:

Press [SHIFT] [B] [3] [SHIFT] [:] [2] [SHIFT] [/] [9] [ENTER].

2. The LCD displays the logical address on the top line and the on/off status of that bit on the bottom line:

B3:2/9
..... 0

For more information on logical addressing, see appendix B.

Backspace Function During Data File Address Entry

If you made an error while entering a data file address (and have not pressed **[ENTER]** yet), you can use the Backspace Function to delete characters and re-type the address.

The following strings are deleted in one keystroke:

- .ACC
- .LEN
- .POS
- .PRE

When you enter data table addresses, text entry is from left to right. In the example below, **T255:7.PRE** has just been entered. The cursor is to the right of **PRE**.

```
RDY>    4    RRUN
T255:7.PRE█
```

If you press and release the **[SHIFT]** key, and then press and release the **[ESC]** key, the display appears as:

```
RDY>    4    RRUN
T255:7█
```

Backspacing over the first character that you entered returns the information previously displayed on line two.

Quick Access Addressing

The module provides you with a shorthand method of data file addressing for default files 3 through 7. Type the file identifier: **B**, **T**, **C**, **R** or **N**, then **[ENTER]**. The module displays the first address within that file.

1. For example, to display the first address in the Integer file:
Press **[SHIFT] [N] [ENTER]**.
The module displays:

N7:0	123
-------------	------------

2. You can now use the **[NEXT]** and **[PREV]** keys to step through all the addresses contained in that file. This is explained later in this chapter.

You may also access a specific element within a data file.

1. To display the Input Image Table word for slot 2:
Press **[SHIFT] [I] [2] [ENTER]**.
2. The module displays the logical address on the top and the on/off status of each of the bits associated with that word on the bottom line:

I1:2.0
0000111100110101

Important: Input and Output Image Table words can only be monitored. The Input Image data file represents external input conditions and cannot be modified by the module. The Output Image data file is controlled by the user program and cannot be modified by the module.

You may use shorthand addressing to display an address at the bit level.

- To display the on/off status of the bit B3:1/14:
Press **[SHIFT] [B] [SHIFT] [/] [3] [0] [ENTER]**.
The display shows the logical address on the top line and the on/off status of *that* bit on the bottom line:

B3:1/14
. 1

- You can now use the **[INC]** and **[DEC]** keys to step through each bit in that word. This is explained later in this chapter.

The following chart shows you how shorthand addressing corresponds to the logical addresses in processor memory:

Keyboard Entry	Data File Address
O0 to O31	O0:0.0 to O0:31.0
I0 to I31	I1:0.0 to I1:31.0
B0 to B255	B3:0 to B3:255
T0 to T255	T4:0 to T4:255
T0.PRE to T255.PRE	T4:0.PRE to T4:255.PRE
T0.ACC to T255.ACC	T4:0.ACC to T4:255.ACC
C0 to C255	C5:0 to C5:255
C0.PRE to C255.PRE	C5:0.PRE to C5:255.PRE
C0.ACC to C255.ACC	C5:0.ACC to C5:255.ACC
R0 to R255	R6:0 to R6:255
R0.POS to R255.POS	R6:0.POS to R6:255.POS
R0.LEN to R255.LEN	R6:0.LEN to R6:255.LEN
N0 to N255	N7:0 to N7:255

Data File addresses may be entered from any Attached display except the Data Entry display, described later in this chapter.

Entering Data File Addresses

The following flowchart shows you the variations available for entering data file addresses:

Entering Input and Output Addresses

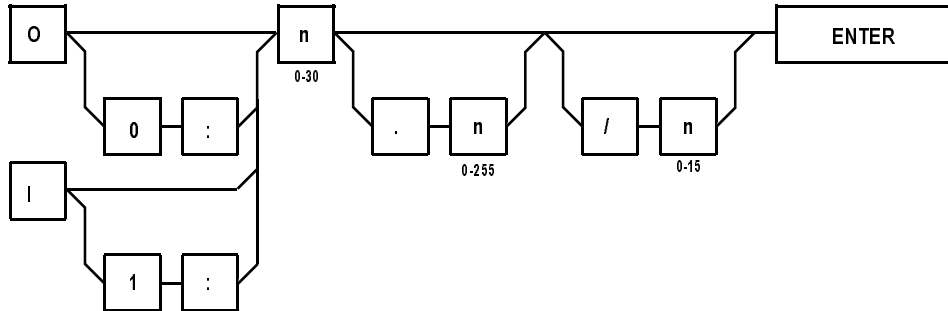

Entering Bit Addresses

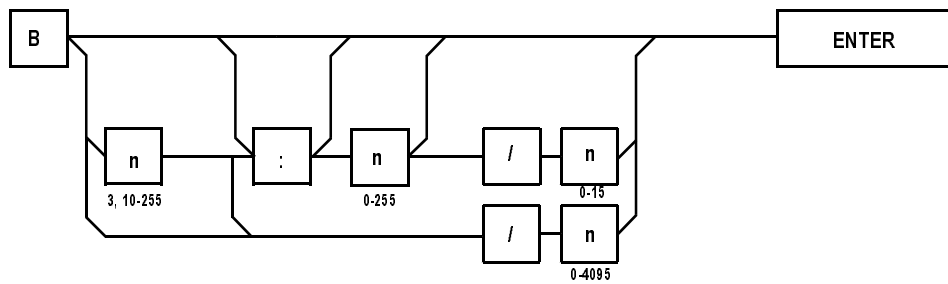

Entering Timer and Counter Addresses

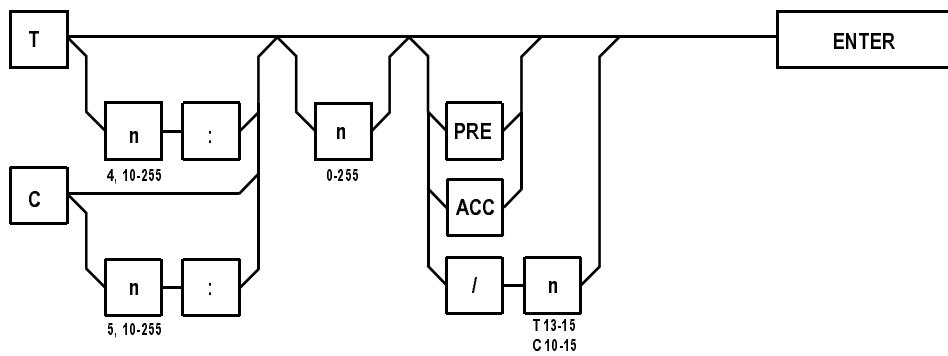

Entering Control Register Addresses

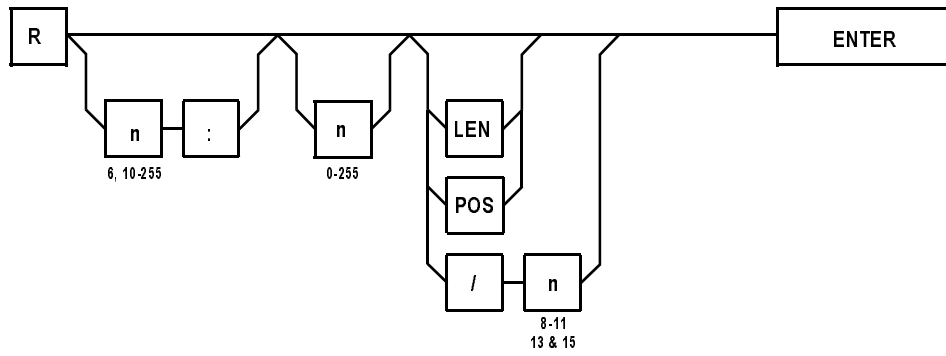

Entering Integer Addresses

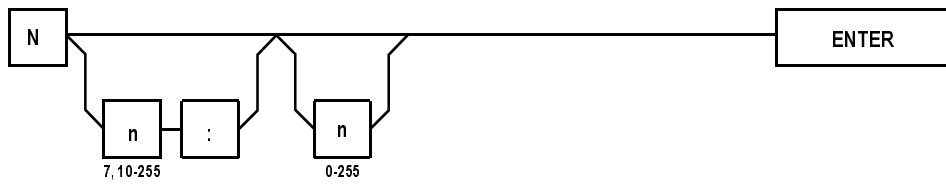

How to Change Displayed Data File Addresses

Once you have the desired data file address displayed on the module, you may display different addresses within that file by using the [NEXT], [PREV], [INC] and [DEC] keys. You may also monitor or modify data contained at that address. This will be described later in this chapter.

How to Display Higher and Lower Word Addresses

When a single element word address is displayed, such as Integer or Bit file words, you may use the [NEXT] and [PREV] keys to view a different address.

- To display the next higher address, press the [NEXT] key. If the address displayed is at the word level:

N11:25	468
--------	-----

Press [NEXT].

The display shows the next address along with its associated value:

N11:26	0
--------	---

- To display the next lower address, press the [PREV] key. If the address displayed is at the bit level:

B3:2/51.....
--------	-------------

Press [PREV].

The display shows the previous word address with its associated value or bit pattern:

B3:1/50.....
--------	-------------

When the address displayed is at the bit level, only the on/off state of *that* bit is displayed.

The [NEXT] and [PREV] keys work the same with multiple word element addresses, such as Timer, Counter, and Control file addresses. The keys permit you to display the next or previous words within the displayed element before displaying a different element.

How to Display Different Word Addresses Within Elements

When a Timer, Counter and Control address is displayed, the [NEXT] and [PREV] keys work as follows:

1. To view the three words of counter C5:3, display the address as described in the previous section. The display shows the most significant bit of the control word:

C5:3.0/15	CU = 0
------------------	---------------

Press [NEXT].

2. The display shows the Preset word and the value stored there:

C5:3.PRE	500
-----------------	------------

Press [NEXT].

3. The display shows the Accumulator word and its associated value:

C5:3.ACC	0
-----------------	----------

Press [NEXT].

4. The display shows the Control word of the next highest Counter in the file:

C5:4.0/15	CU =0
------------------	--------------

The [PREV] key works in the same fashion.

The [NEXT] and [PREV] keys can be used to display all valid addresses contained within a data file. The keys do not allow you to cross file boundaries. If the [NEXT] key is pressed when the highest address within a file is displayed, the display rolls over to the lowest address in that file. If the [PREV] key is pressed with the first address of a file displayed, the display shows the highest address in that file.

How to Display Different Control Bits Within Elements

With a data file address displayed, you may use the [INC] and [DEC] keys to display different bits within a Timer, Counter, or Control word, or change bit addresses within a Bit element.

When a Timer, Counter, and Control address is displayed, the [INC] and [DEC] keys work as follows:

1. To view the Control bits in T4:3, display the address as previously described. The display shows the highest numbered Control bit, with the address on the top left and the bit function and on/off state in the lower right-hand corner:

T4:3.0/15	EN = 0
------------------	---------------

Press [DEC].

2. The LCD displays the original bit and the next lower numbered bit. The bit address in the upper left-hand corner corresponds to the function and state in the lower right-hand corner:

T4:3.0/14	EN = 0	TT = 0
------------------	---------------	---------------

Press [DEC].

3. The display shows the next lowest bit in the Control word:

T4:3.0/13	EN = 0	TT = 0	DN = 1
------------------	---------------	---------------	---------------

The [DEC] key works in the same fashion.

A maximum of three Control bits may be displayed at one time. Only the Control bit displayed in the lower right-hand corner can be manipulated. Use the [INC] and [DEC] keys to access any other bits.

Another function of the [INC] and [DEC] keys is to change the Bit address displayed on the LCD.

When a Bit file address is displayed at the bit level, the [INC] and [DEC] keys work as follows:

How to Display Different Bit File Addresses

To increment the Bit address from B10:7/13:

B10:7/13
.. 1

Press [INC].

The next highest bit address in that word displays along with its associated on/off state:

The [DEC] key decrements addresses in the same fashion.

If the highest bit address in the element is displayed and the [INC] key is pressed, the display rolls over to display the lowest bit address in that element. The [DEC] key works in the same fashion.

How to Change Data File Values

Once you have the desired data file address displayed on the module, you may change the value stored there, change the sign of an Integer value, or change the on/off status of individual bits.

How to Change Word Values

You can change the value of a displayed word by using the [INC] and [DEC] keys or by entering new values, using the numeric keys.

You may use the [INC] and [DEC] keys to change values stored at data file word addresses.

1. To increment the value stored at T4:3.PRE:

T4:3.PRE	25
-----------------	-----------

Press [INC].

2. The LCD displays the new value in the lower right-hand corner and the previous value in the lower left-hand corner:

T4:3.PRE	26
25	

3. You may continue pressing the [INC] or [DEC] keys until the appropriate value is displayed, then:
Press [ENTER].

4. The address displays with the new value in the lower right-hand corner:

T4:3.PRE	26
-----------------	-----------

When pressing these keys, the longer you hold the key, the faster the values change.

When you use the [**INC**] and [**DEC**] keys, the module display automatically rolls over or under the value when the numeric high or low limit of the data file is reached. The following table lists the values for the different files:

Data File	Roll Over/Under Range
Timer PRE and ACC	Roll over at 32767 to 0 Roll under at 0 to 32767
Counter PRE and ACC	Roll over at 32767 to -32768 Roll under at -32768 to 32767
Control LEN and POS	Roll over at 32767 to 0 Roll under at 0 to 32767
Integer	Roll over at 32767 to -32768 Roll under at -32768 to 32767

You may also use the numeric keys to enter or change a value at a displayed address.

- To enter the value 567 into T4:5.PRE:

T4:5 PRE	0
-----------------	----------

Press [**5**] [**6**] [**7**] [**ENTER**].

The address and the new value displays:

T4:5 PRE	567
-----------------	------------

Important: Once data entry has been initiated, you may not attempt to display different addresses. You must either finish the data entry and press [**ENTER**] or press [**ESC**].

Once data entry has been initiated, if you press the [**ESC**] key or switch the module from Modify to Monitor mode, the new value is lost.

How to Change the Sign of a Value

The [+/-] key may be used to change the sign of signed integers contained in the Counter or Integer data files.

- For example, to change the sign of the signed integer value 56 stored at word N20:7:

N20:7	56
-------	----

Press [5] [+/-] [6] [ENTER].

The module displays:

N20:7	-56
-------	-----

Important: To enter a negative number into an address, you must enter at least one numeric value before pressing the [+/-] key.

Backspace Function During Data File Value Entry

If you make an error while entering a data file value (and have not pressed [ENTER] yet), you can use the Backspace Function to delete characters and re-type the value. In the example below, integer value 56 has just been entered.

The cursor is positioned to the right of the 6.

N20:7	56
789	

If you press and release the [SHIFT] key, then press and release the [ESC] key, the display appears as:

N20:7	5
789	

Backspacing over the first character abandons the integer entry. The module then returns to monitoring the data file address and the original data value.

How to Change Bit Status at the Word Level

You may change the on/off status in Bit file words with the 16-bit *word* displayed.

1. To change the bit pattern in B3:10, display the word address:

```
B3:10
0000000000000000
```

Press [1] .

2. The display changes to reflect the state of the least significant bit:

```
B3:10
0000000000000001
```

3. A blinking cursor appears over the next bit to the left. Each time you press a [1] or [0] the cursor moves one bit to the left. When you have displayed the desired bit pattern:
Press [ENTER].

Cursor Right Function During Binary Data Entry

During binary data entry, you can move the cursor one position to the right each time you use the Cursor Right Function.

There are two ways to implement the Cursor Right Function:

- *Single Cursor Right* - press and release the [SHIFT] key, then press and release the [ESC] key
- *Multiple Cursor Right* - press and hold the [SHIFT] key, then repeatedly press the [ESC] key

In the example below, the cursor is to the left of the 1. The cursor was placed there by entering 0,0,0,0,0,1.

```
B3:10
0000000000100000
```

To change the value to 0000000000101000, you can use the following key sequence:

1. Press and hold the [SHIFT] key.
2. Press [ESC] [ESC] [ESC].
3. Release the [SHIFT] key.
4. Press [1].

The display appears as shown below:

```
B3:10
0000000000101000
```

How to Change Bit Status at the Bit Level

You may also change the on/off status of a bit, with a Bit file word displayed at the *bit* level.

For example, to change the status of bit B3:2/3 to Off:

1. Display the address to the bit level:

```
B3:2/3
.....1..
```

Press [0].

2. The Off state of the bit displays, and a blinking cursor appears over the bit:

```
B3:2/3
.....0.
```

3. To change the state of the bit in memory:
Press [ENTER].
4. The zero remains on the display and the cursor disappears.

Quick Recall Functions

This chapter describes how to:

- define Quick Recall Functions
- use Quick Recall Functions
- clear Quick Recall Functions

Quick Recall Function Overview

The module has the capability to let you define and use up to 10 data file address Quick Recall Functions. These functions are stored in the module's nonvolatile memory. They allow you to assign frequently accessed data file addresses to a simplified keystroke procedure. You may later recall these addresses by pressing two keys instead of using the addressing procedure described in the previous chapter.

Quick Recall Functions also provide the ability to write data to selected data file addresses when the module is configured for the **Monitor** mode. This **Monitor Override** feature is enabled in the Module Setup Procedure described in chapter 3.

Defining Quick Recall Functions

The available Quick Recall Functions are numbered F(0) through F(9). For example, to assign address T4:1.ACC to Quick Recall Function F(1):

1. Configure the module for the **Modify** mode.
2. Make sure the module is attached to a processor.
3. Enter the data file address:
Press [SHIFT] [T] [1] [ACC] [ENTER].
4. The address and its current value are displayed:

T4:1.ACC	9999
----------	------

5. To define Quick Recall Function F(1):
Press [SHIFT] [F()] [F()] [1] [ENTER].
6. The Quick Recall Function for that address is now stored in the module nonvolatile memory. The display shows the following for three seconds:

T4:1.ACC Macro 1 Defined

7. The display then returns to the previous address display:

T4:1.ACC	9999
-----------------	-------------

8. You may now perform any of the module functions.

Important: If the unit is connected to a DH485 Network, the module is able to communicate with multiple processors on the network. Any data file address assigned to a Quick Recall Function and stored in the module's nonvolatile memory is accessible in any processor data file on the network to which the module is attached.

Using Quick Recall Functions

After defining the Quick Recall Function, you are able to recall that data file address at any time. The module may be configured for the **Modify or Monitor** modes.

In the **Monitor** mode, if the unit has been configured with the Monitor Override feature set to **On**, you can modify data at that data file address by recalling the Quick Recall Function.

Important: Data can be modified in the **Monitor** mode with the Monitor Override set to **On** only at the address displayed by a Quick Recall Function. Addresses displayed using the **[NEXT]**, **[PREV]**, **[INC]** or **[DEC]** keys can be monitored but not modified in this mode.

1. Make sure the module is attached to a processor.
2. To recall Quick Recall Function F(1), from any screen:
Press **[F()]** **[1]**.
3. The module displays the data file address assigned to that Quick Recall Function:

T4:1.ACC	9999
-----------------	-------------

4. You are now able to view or alter the data at this data file address using the procedures described in the previous chapter.

Clearing Quick Recall Functions

To erase Quick Recall Function F(1), make sure that no data file address is displayed (otherwise you will re-define the Recall Function or Macro):

1. Configure the module for the **Modify** mode.
2. With either Ready screen displayed:
Press [**SHIFT**] [**F()**] [**F()**] [**1**] [**ENTER**].
3. The LCD displays the following for three seconds:

RDY> 4 RRUN
Macro 1 Cleared

4. The display returns to the previous screen.
5. You may now perform any of the module functions.

Processor Control Functions

This chapter describes the procedures to:

- change processor modes
- view and clear processor faults
- transfer user programs between RAM and EEPROM memory

Changing the Processor to Run Mode

The module must be configured for the Modify mode to change the processor to Run mode. If the module is attached to a 5/03 processor, the keyswitch must also be in the REM position to change the processor mode.

When the module is attached to a processor, the module displays the Ready Attached screen with the processor operating mode displayed in the upper right-hand corner:

```
RDY> 4 RHALT
5/02 1111
```

1. To place the attached processor into the Run mode from any screen where data is not being entered:
Press [F()] [SHIFT] [O] .

2. The module displays:

```
Enter RUN,
Confirm?
```

3. To confirm:
Press [ENTER] .
4. The processor enters the Run mode and the module displays:

Changing the Processor to Program Mode

The module must be configured for the Modify mode to change the processor to Program mode. If the module is attached to a 5/03 processor, the keyswitch must also be in the REM position to change the processor mode.

1. To place the attached processor into the Program mode:
Press **[F()] [SHIFT] [C]**.

2. The display shows:

```
Halt CPU
Confirm?
```

3. To confirm:

Press **[ENTER]**.

4. The processor enters the Program mode and the module displays:

```
RDY> 4 RHALT
5/02 1111
```

If the **[ESC]** key is pressed at either Confirm screen, the display returns to the previous Ready Attached screen, and the processor mode is not changed.

If any problem occurs during the mode change procedures, the module displays the appropriate error message. Refer to chapter 9, Troubleshooting.

Viewing Processor Faults

When the module is configured for the Modify or Monitor mode, you are allowed to view attached processor faults.

1. To view a fault code while attached to a processor, from any screen:

Press **[F()] [SHIFT] [B]**.

2. The module displays the appropriate error code, in hexadecimal format, and a description for three seconds:

```
CPU Fault: 0022H
WATCHDOG TIMEOUT
```

3. The display returns to the Ready Attached screen with the word **FAULT** flashing in the upper right hand corner:

```
RDY> 4 FAULT
5/02 1111
```

If you are entering a data file address or data when a processor fault occurs, the fault screen is held until completion of the entry.

Clearing Processor Faults

The module must be configured for the Modify mode to clear recoverable faults in the attached processor.

1. You may first choose to view a fault condition as described in the previous section.
2. To clear a fault, initiate the Clear Fault procedure from any screen:
Press **[F()] [SHIFT] [T]**.



ATTENTION: If the DTAM is attached to a 5/03 and the processor keyswitch is in the RUN position when you start to clear the fault, the processor enters the RUN mode once the fault is cleared.

3. If the DTAM is not attached to a 5/03 with the keyswitch in RUN, the fault clears, and the processor is placed in the Program mode.
4. The Ready Attached screen displays:

```
RDY> 4 RHALT
5/02 1111
```

5. You may now return the processor to the Run mode or initiate other module functions.

Important: Before trying to place the processor in the Run mode, you must ensure that the cause of the fault has been corrected. If it is not rectified, the processor returns to the faulted condition as soon as you attempt to place it in Run mode.

For additional information on faults and fault codes refer to chapter 9, *Troubleshooting*.

Transferring Memory from EEPROM to RAM

You may transfer a program between processor EEPROM and RAM memory.

To transfer EEPROM to RAM, from any display:

1. Configure the module for the Modify mode.
2. Make sure the processor is in the Program mode.
3. To initiate the memory transfer:
Press [F()] [SHIFT] [R].

4. The module displays:

```

PROM -> CPU RAM,  
Confirm?
```

5. To confirm:
Press [ENTER].
To abort the memory transfer:
Press [ESC]. The display returns to the previous Ready Attached screen.

6. When the transfer is initiated, the module displays:

```

PROM -> CPU RAM,  
Working . . . .
```

7. If the memory transfer is successful, the module displays:

```

PROM -> CPU RAM,  
Transfer Success
```

If the program contained in the EEPROM is password-protected, you are required to re-enter the password at this point.

8. When the transfer is complete (or the password is entered, if required), the module displays the Ready Attached screen:

```

RDY> 4 RHALT  
5/02 1111
```

If an error occurs during the transfer, an error message displays on the bottom line of the display. Refer to chapter 9, *Troubleshooting*.

Transferring Memory from RAM to EEPROM

To transfer a program from processor RAM to EEPROM memory, from any display:

1. Configure the module for the Modify mode.
2. Make sure the processor is in the Program mode.
3. To initiate the memory transfer:
Press **[F()] [SHIFT] [N]**.
4. The module displays:

**CPU RAM -> PROM,
Confirm?**

5. To confirm:
Press **[ENTER]**.
If the **[ESC]** key is pressed at the Confirm screen, the display returns to the previous Ready Attached screen, and the memory transfer is aborted.
6. When the transfer is initiated, the module displays:

**CPU RAM -> PROM,
Working**

7. If the memory transfer is successful, the module displays:

**CPU RAM -> PROM,
Transfer Success**

8. When the transfer is complete, the module returns to the Ready Attached screen.

If an error occurs during the transfer, an error message displays on the bottom line of the display. Refer to chapter 9, *Troubleshooting*.

Message Capability

This chapter provides:

- an overview of the message types
- programming parameters for the MSG instruction
- control block configuration for the 5/02 and 5/03 MSG instructions
- operational descriptions of the message types
- sample SLC 5/02 user programs

Message Overview

The module supports six types of messages. The table below describes the functions of each:

Message Type	Functions
8-Word	16 characters Displayed on one line Display-only
16-Word	32 characters Displayed on two lines Display-only
12-Word	16 characters Operator reply Initial value of zero
13-Word	16 characters Operator reply User-defined initial value
18-Word	16 characters Operator reply User-defined initial value User-defined acknowledge bit addresses
1-Word	Clear message

Other module message capabilities are:

- display Write messages from any DH485 network device with message capability
- display messages in the Monitor or Modify modes
- enter data in the Monitor or Modify modes
- message overwrite protection

Important: SLC 500 Fixed and SLC 5/01 Modular Controllers do not support message capability.

Programming the MSG Instruction

The DTAM message is configured in the 5/02 or 5/03 processor user program by selecting a message (MSG) instruction and entering the following parameters:

Message Type:	Write
Target Device:	485CIF
Network Type (5/03 only):	Local or Remote
Control Block Address:	Starting address of an unused block of 7 words (5/02) or 14 words (5/03) in any bit or integer file (to store message status)
Source File Address:	Starting address of an unused block of x words in any bit or integer file (to store message text), where x = message length or the DTAM message type
Target Node Address:	DTAM node address (as defined in the module set-up procedure), 0 through 31 inclusive
Offset:	Message overwrite capability: 0 for cannot overwrite or 100 for can overwrite
Message Length:	Number of words in selected DTAM message type (1, 8, 12, 13, 16, or 18)
Channel (5/03 only):	Processor communication port: 1 for DH485 channel or 0 for RS232 channel

5/02 Control Block Configuration

Most of the MSG instruction parameters are stored in its associated control block. The “delivery” status and any error code of the message are also stored there. The information below describes the message instruction control block layout necessary to display messages on the DTAM:

Bit/ Word	15	14	13	12	11	10	9	8	7	6	5	4	3	2	1	0
0	EN	ST	DN	ER		EW	NR	TO	Error Code							
1	DTAM Node Address															
2	Message Length in Words (Read Only)															
3	Offset Word (0 or 100)															
4	Not Used															
5	Not Used															
6	Not Used															

- Word 0** Control bits:
- EN Enable bit
 - ST Start bit
 - DN Done bit
 - ER Error Bit, used with the Error code. Refer to chapter 9, *Troubleshooting*
 - EW Enabled and waiting bit
 - NR No response bit
 - TO Time out bit
- Word 1** DTAM node address, 0-31 inclusive.
- Word 2** Message length: 1, 8, 12, 13, 16 or 18 words (Read only).
- Word 3** The value in the offset word determines whether or not a displayed message is overwritten by a new message. If the value entered in this word is:
- 0** This message cannot overwrite the previously displayed message.
 - 100** This message can overwrite the displayed message.

After the MSG instruction is entered in the ladder program, the local source file block (or message text) is entered through the Data Monitor Function. The format of the local source file block depends on the type of message length chosen.

The next sections describe the different messages and the format of each local source file block. Refer to the *SLC 500™ and MicroLogix™ 1000 Instruction Set Reference Manual* (Catalog number 1747-6.15) for more information on the MSG instruction.

5/03 Control Block Configuration

Most of the MSG instruction parameters are stored in its associated control block. The “delivery” status and any error code of the message are also stored there. The information below describes the message instruction control block layout necessary to display messages on the DTAM:

Bit/ Word	15	14	13	12	11	10	9	8	7	6	5	4	3	2	1	0
0	EN	ST	DN	ER	CO	EW	NR	TO	Error Code							
1	DTAM Node Address															
2	Message Length in Words (Read Only)															
3	Offset Word (0 or 100)															
4	Not Used															
5	Not Used															
6	Not Used															
7	Reserved (Internal Messaging Bits)															
8	Message Timer Preset															
9	Message Timer Scaled Zero															
10	Message Timer Accumulator															
11	Reserved (Internal Use Only)															
12	Reserved (Internal Use Only)															
13	Reserved (Internal Use Only)															

- Word 0** Control bits:
- EN Enable bit
 - ST Start bit
 - DN Done bit
 - ER Error Bit, used with the Error code. Refer to chapter 9, *Troubleshooting*
 - CO Continuous operation bit
 - EW Enabled and waiting bit
 - NR No response bit
 - TO Time out bit
- Word 1** DTAM node address, 0-31 inclusive.
- Word 2** Message length: 1, 8, 12, 13, 16 or 18 words (Read only).
- Word 3** The value in the offset word determines whether or not a displayed message is overwritten by a new message. If the value entered in this word is:
- 0** This message cannot overwrite the previously displayed message.
 - 100** This message can overwrite the displayed message.
- Word 7** Control bits:
- WQ Waiting for queue space bit
- Word 8** Message time-out, how long the processor will wait for a reply from the DTAM, 0-255 seconds.

After the MSG instruction is entered in the ladder program, the local source file block (or message text) is entered through the Data Monitor Function. The format of the local source file block depends on the type of message length chosen.

The next sections describe the different messages and the format of each local source file block. Refer to the *SLC 500™ and MicroLogix™ 1000 Instruction Set Reference Manual* (Catalog number 1747-6.15) for more information on the MSG instruction.

8-Word Message

This is a 16-character, one-line message. It is a display-only message requiring no operator response. If data is not being entered, the message is displayed as soon as it is received by the module. The message appears on the top line of the display:

8 Word Message

- The message remains on the display until it is overwritten by another message or any module key is pressed.
- When the message is cleared, the screen returns to the previous display.

The message text is stored in processor memory at the local source file address that is designated in the message instruction. The table below describes the message instruction local source file block layout:

Word	Block Description	Word Description
0	16-Character Message Text Block	2 ASCII Characters per Word
1		
2		
3		
4		
5		
6		
7		

For example: If the Local Source File Address is N7:10, the message is stored in words N7:10 through N7:17.

To enter the message text into processor memory, refer to your software user manual.

16-Word Message

This is a 32-character, two-line message. It is a display-only message requiring no operator response. It is functionally identical to the 8-word message except in length. The message appears on both lines of the display:

**16 Word Message
Shown in 2 Lines**

- The message remains on the display until it is overwritten by another message or any module key is pressed.
- When the message is cleared, the screen returns to the previous display.

The message text is stored in processor memory at the local source file address that is designated in the message instruction. The table below describes the message instruction local source file block layout:

Word	Block Description	Word Description
0	32-Character Message Text Block	2 ASCII Characters per Word
1		
2		
3		
4		
5		
6		
7		
8		
9		
10		
11		
12		
13		
14		
15		

For example: If the Local Source File Address is N7:10, the message is stored in words N7:10 through N7:25.

To enter the message text into processor memory, refer to your software user manual.



12-Word Message

This is a display and return message. When the message is displayed, you are prompted to enter data from the module keypad. This value is then written to a user-designated data file address word.

The message text is displayed on the top line, and an initial value of zero is displayed in the lower right-hand corner of the display:

- A signed integer value may be entered using the numeric keys followed by the **[ENTER]** key. When the **[ENTER]** key is pressed, the value is stored at the data entry destination address, and the screen returns to the previous display.
- The message cannot be overwritten while data is being entered.
- Pressing the **[ENTER]** key without entering data writes a zero to the data entry destination address and clears the message from the display.
- Pressing the **[ESC]** key clears the message from the display and does not alter the value previously stored at the data entry destination address.

The message text is stored in processor memory at the local file address that is designated in the message instruction. The data entry destination address block is automatically assigned to the four data file words immediately following the message text as described in the table below.

Important: The programming device does *not* allocate the memory location described in the data entry destination address block. See your software user manual for information on using memory mapping to verify that the memory location exists or to create the data location if it does not exist. Otherwise the DTAM displays **Illegal Command** when it attempts to enter a value into a non-allocated data entry destination.

Word	Block Description	Word Description
0	16-Character Message Text Block	2 ASCII Characters per Word
1		
2		
3		
4		
5		
6		
7		
8	Data Entry Destination Address Block	File Type Identifier
9		File Number
10		Element Number
11		Subelement Number

13-Word Message

This is a display and return message. When the message is displayed, you are required to enter data from the module keypad. It is functionally similar to the 12-word message except a user-defined initial value is displayed in the lower right-hand corner of the display:



- A signed integer value may be entered using the numeric keys followed by the [ENTER] key. When the [ENTER] key is pressed, the value is stored at the data entry destination address, and the screen returns to the previous display.
- The message cannot be overwritten while data is being entered.
- Pressing the [ENTER] key without entering data writes the initial value to the data entry destination address and clears the message from the display.
- Pressing the [ESC] key clears the message from the display and does not alter the value previously stored at the data entry destination address.

The message text is stored at the local file address, followed by the data entry destination address block. The initial value word is automatically assigned to the next data file address following the data entry destination address block.

Important: The programming device does *not* allocate the memory location described in the data entry destination address block. See your software user manual for information on using memory mapping to verify that the memory location exists or to create the data location if it does not exist. Otherwise the DTAM displays **Illegal Command** when it attempts to enter the value into a non-allocated data entry destination.

Word	Block Description	Word Description
0	16-Character Message Text Block	2 ASCII Characters per Word
1		
2		
3		
4		
5		
6		
7		
8	Data Entry Destination Address Block	File Type Identifier
9		File Number
10		Element Number
11		Subelement Number
12		Initial Value Word

To enter the message text into processor memory, refer to your software user manual.

18-Word Message

This is a display and return message. When the message is displayed, you are required to enter data from the module keypad. It is functionally similar to the 13-word message except a user-defined acknowledge bit address block is included to indicate whether or not a message has been responded to.

The message display format is identical to the 13-word message:

- A signed integer value may be entered using the numeric keys followed by the **[ENTER]** key. When the **[ENTER]** key is pressed, the value is stored at the data entry destination address, the user-defined message acknowledge bit is set, and the screen returns to the previous display.
- The message cannot be overwritten while data is being entered.
- Pressing the **[ENTER]** key without entering data writes the initial value to the data entry destination address, sets the acknowledge bit, and clears the message from the display.
- Pressing the **[ESC]** key does not alter the value stored at the data entry destination address, sets the user defined no acknowledge bit, and clears the message from the display.

The table on page 8-11 describes the local source file block layout for the 18-word message. The acknowledge bit address block is automatically assigned to the five data file address words immediately following the initial value word.

Important: The programming device does *not* allocate the memory location described in the data entry destination address block **OR** the acknowledge bit address block. See your software user manual for information on using the memory mapping. Otherwise the DTAM displays **Illegal Command** when it attempts to enter the value into a non-allocated data entry destination or tries to set the non-allocated acknowledge bit.

Word	Block Description	Word Description
0	16-Character Message Text Block	2 ASCII Characters per Word
1		
2		
3		
4		
5		
6		
7		
8	Data Entry Destination	File Type Identifier
9		File Number
10		Element Number
11	Address Block	Subelement Number
12	Initial Value Word	Signed Integer Value
13	Acknowledge Bit Address Block	File Type Identifier
14		File Number
15		Element Number
16		Subelement Number
17		Bit Number (0 - 15)

To enter the message text into processor memory, refer to your software user manual.

1-Word Message

This is a clear message. It is enabled by the user program to clear a displayed message. This message acts the same as pressing the module [ESC] key.

The message instruction must be configured as follows:

Read/Write: **Write**
 Target Device: **485 CIF**
 Control Block: *Any Bit or Integer File*
 Local Source File Address: *Any Bit or Integer File*
 Target Node: *Module Node Address*
 Target Offset: **100**
 Message Length in Elements: **1**

Application Example 1

Application example 1 uses two 18-word message instructions to enter variable data for high and low limits of a machine process. It also uses an 8-word message instruction to prompt you if data is not entered. The 5/02 ladder logic program is shown below. The data monitor displays for the message instructions and the user-defined data files are shown on the following page. The procedure to display the message is shown on page 8-16.

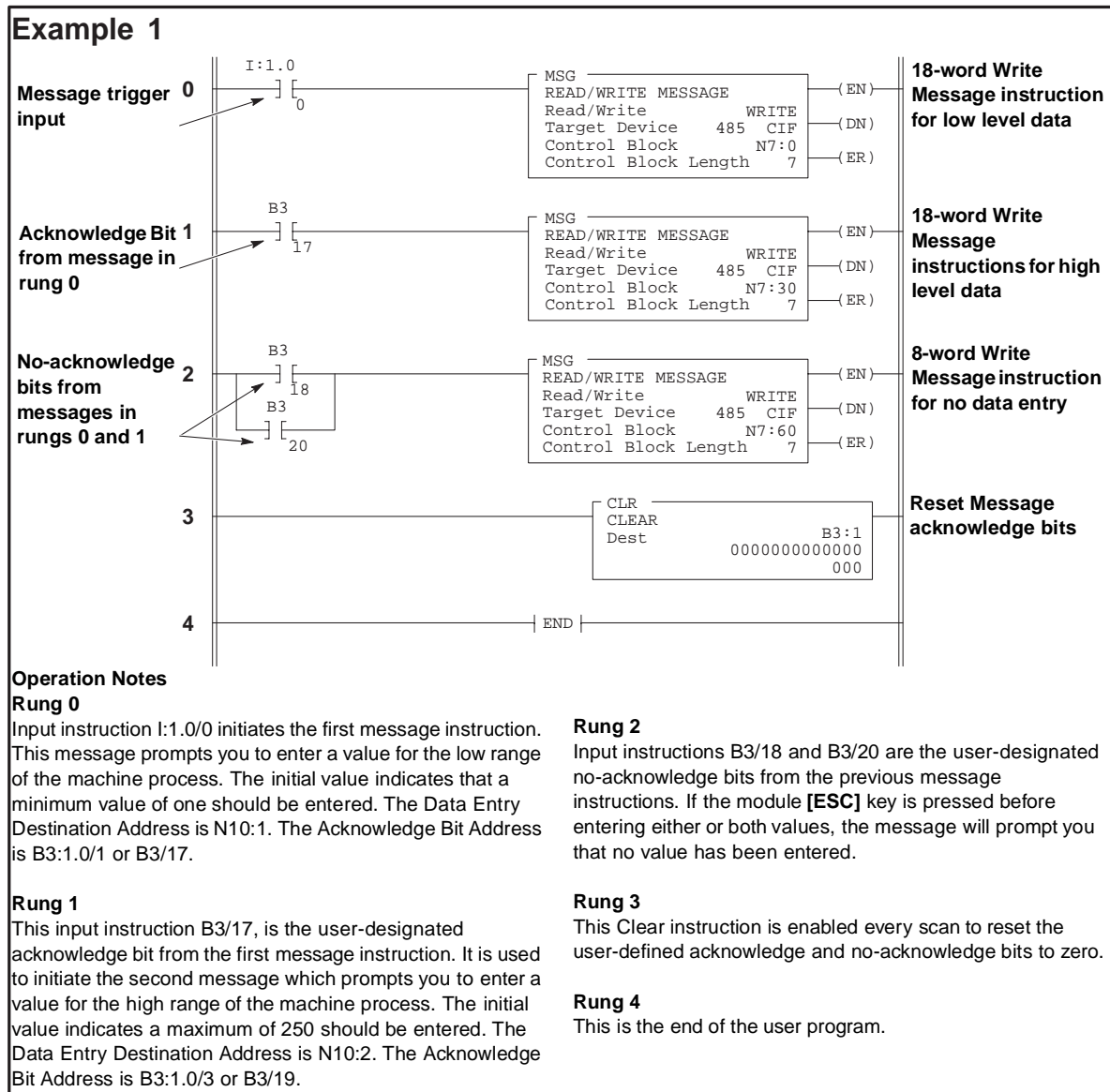

The following example is the data monitor display for the 18-word message instruction in Rung 0:

Read/Write:	WRITE	ignore if timed out:	0	TO
Target Device:	485 CIF	to be retried:	0	NR
Control Block:	N7:0	awaiting execution:	0	EW
Local Source File Address:	N7:10		0	
Target Node:	2	error:	0	ER
Target Offset:	100	message done:	0	DN
Message Length in elements:	18	message transmitting:	0	ST

Below is the data monitor display for the message control block and the local source file, followed by an explanation of the data file.

Address	0	1	2	3	4	5	6	7	8	9
N7:0	0	2	18	100	0	0	0	0	0	0
N7:10	E	N	T	E	R	L	O	W	R	A
N7:20	1	0	1	3	3	1	0	1	0	0

For ease of viewing, N7:10 through N7:17 are displayed in the ASCII radix. The rest of the file is displayed in Decimal.

7-word message control block: N7:0 through N7:6

- N7:0 = 0 message status
- N7:1 = 2 DTAM node address
- N7:2 = 18 message length
- N7:3 = 100 offset (overwrite capability)

N7:4 through N7:6 = unused

18-word local source file: N7:10 through N7:27

N7:10 through N7:17 8-word message text
 N7:18 through N7:21 data entry destination address

In this example the data entry destination address is N10:1. Memory locations N7:18 through N7:21 are assigned as follows:

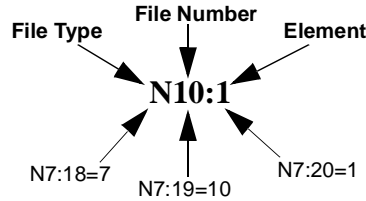

Important: N10:1 must be allocated. See your software user manual. Otherwise the DTAM displays **Illegal Command**.

N7:22 = 1 initial value word
 N7:23 through N7:27 acknowledge bit address

In this example the acknowledge bit address is B3:1.0/1. Memory locations N7:23 through N7:27 are assigned as follows:

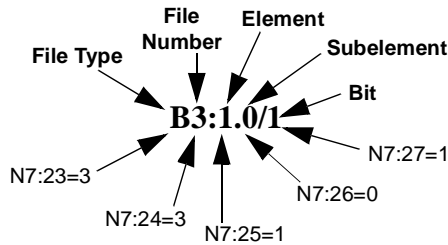

The following example is for the 18-word message in rung 1:

Read/Write:	WRITE	ignore if timed out:	0	TO
Target Device:	485 CIF	to be retried:	0	NR
Control Block:	N7:30	awaiting execution:	0	EW
Local Source File Address:	N7:40		0	
Target Node:	2	error:	0	ER
Target Offset:	100	message done:	0	DN
Message Length in elements:	18	message transmitting:	0	ST

Below is the data monitor display for the message control block and the local source file, followed by an explanation of the data file.

Address	0	1	2	3	4	5	6	7	8	9
N7:30	0	2	18	100	0	0	0	0	0	0
N7:40	E	N	T	E	R	H	I	G	H	R
N7:50	2	0	250	3	3	1	0	3	0	0

For ease of viewing, N7:40 through N7:47 are displayed in the ASCII radix. The rest of the file is displayed in Decimal.

7-word message control block: N7:30 through N7:36

- N7:30 = 0 message status
- N7:31 = 2 DTAM node address
- N7:32 = 18 message length
- N7:33 = 100 offset (overwrite capability)

N7:34 through N7:36 = unused

18-word local source file: N7:40 through N7:57

- N7:40 through N7:47 8-word message text
- N7:48 through N7:51 data entry destination address

In this example the data entry destination address is N10:2. Memory locations N7:48 through N7:51 are assigned as follows:

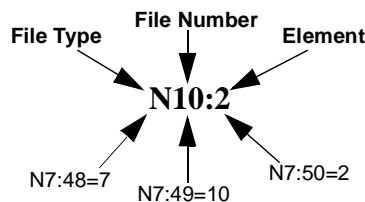

Important: N10:2 must be allocated. See your software user manual. Otherwise the DTAM displays **Illegal Command**.

- N7:52 = 250 initial value word
- N7:53 through N7:57 acknowledge bit address

In this example the acknowledge bit address is B3:1.0/3. Memory locations N7:53 through N7:57 are assigned as follows:

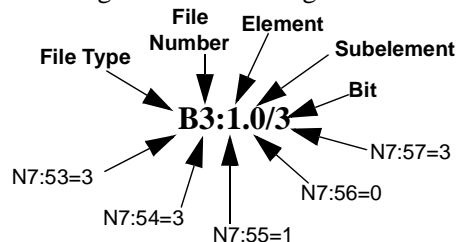

The following example is for the 8-word message in rung 2:

Read/Write:	WRITE	ignore if timed out:	0	TO
Target Device:	485 CIF	to be retried:	0	NR
Control Block:	N7:60	awaiting execution:	0	EW
Local Source File Address:	N7:70		0	
Target Node:	2	error:	0	ER
Target Offset:	100	message done:	0	DN
Message Length in elements:	8	message transmitting:	0	ST

Below is the data monitor display for the message control block and the local source file, followed by an explanation of the data file.

Address	0	1	2	3	4	5	6	7	8	9
N7:60	0	2	8	100	0	0	0	0	0	0
N7:70	N	O	V	A	L	U	E	E	N	T
	E	R	E	D	0	0				

For ease of viewing, N7:60 through N7:67 are displayed in the ASCII radix. The rest of the file is displayed in Decimal.

7-word control block: N7:60 through N7:66

N7:60 = 0 message status

N7:61 = 2 DTAM node address

N7:62 = 8 message length

N7:63 = 100 offset (overwrite capability)

N7:64 through N7:66 = unused

8-word local source file: N7:70 through N7:77

N7:70 through N7:77 8-word message text

The ladder logic and data monitor examples on the previous pages must be programmed in SLC 5/02 processor memory for the following module message display:

1. When the input in rung 0 becomes true, the module displays this message and the suggested low value to be entered:

ENTER LOW RANGE 1

2. To enter a value:

- Accept the displayed value:
Press [ENTER] .
- Use the numeric keys to change the value:
Press [ENTER] .

3. The value is written to the data entry destination address, and the module displays the next message in the sequence, with the suggested high value:

ENTER HIGH RANGE 250

- Accept the displayed value:
Press [ENTER] .
- Use the numeric keys to change the value:
Press [ENTER] .

4. The value is written to the data entry destination address, and the module display returns to the screen displayed before the first message was received.

If you press the **[ESC]** key before the **[ENTER]** key while either of these messages is displayed, the value in the data entry destination address remains unchanged, and the module displays:

NO VALUE ENTERED

5. Press any key to clear this message. The display returns to the previous screen.

Application Example 2

Application example 2 uses a 12-word message instruction to enter a value to a data file word. It also uses a timer and a clear message instruction to clear the message from the display if data is not entered. The 5/02 ladder logic program is shown on the next page. The data monitor displays for the message instructions and the user defined data files are shown on the following page. The procedure to display the message is shown on page 8-20.

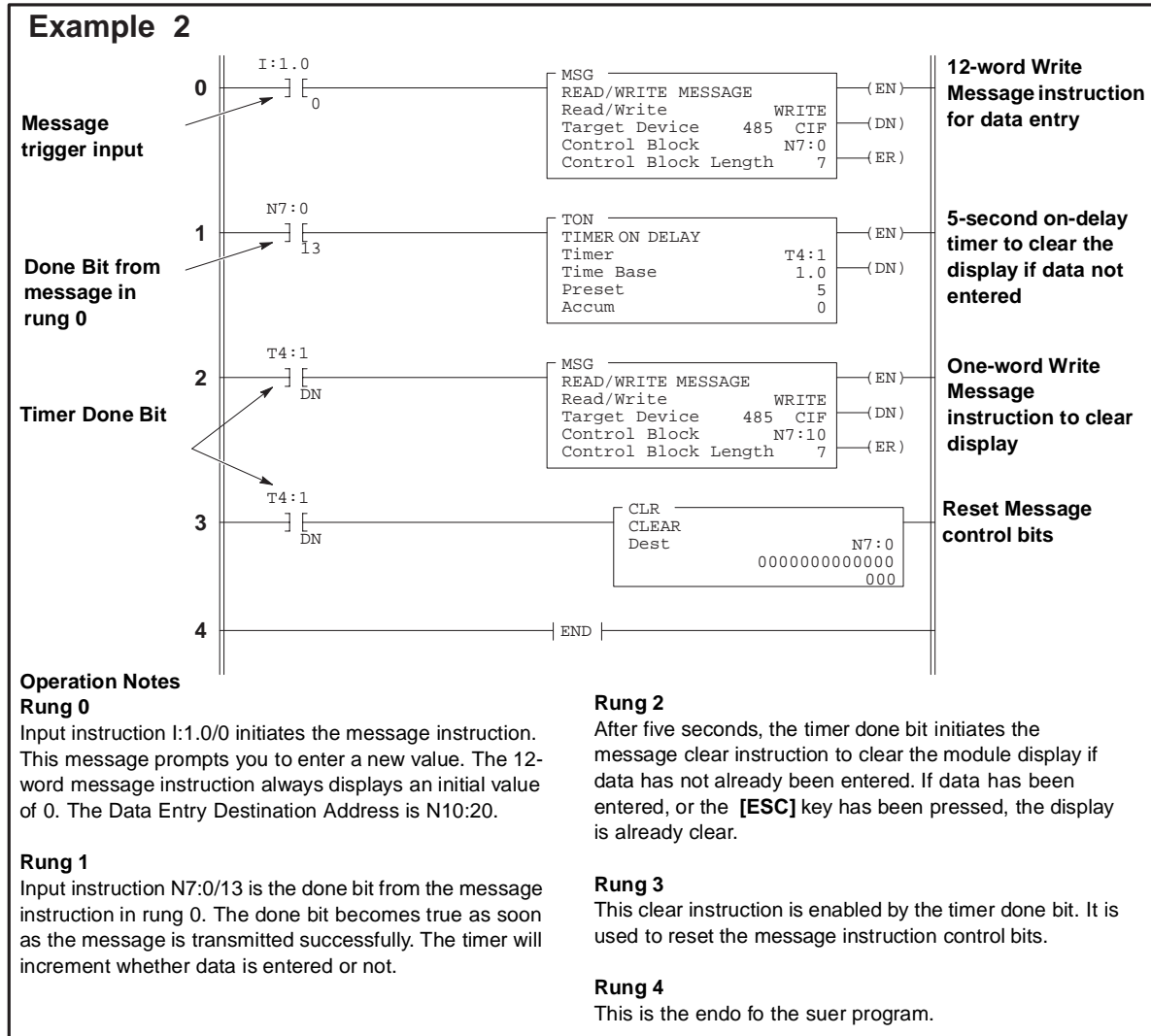

The following example is the data monitor display for the 12-word message instruction in Rung 0:

Read/Write:	WRITE	ignore if timed out:	0	TO
Target Device:	485 CIF	to be retried:	0	NR
Control Block:	N7:0	awaiting execution:	0	EW
Local Source File Address:	N10:0		0	
Target Node:	2	error:	0	ER
Target Offset:	100	message done:	0	DN
Message Length in elements:	12	message transmitting:	0	ST

Below is the data monitor display for the message control block, followed by an explanation of the data file.

Address	0	1	2	3	4	5	6	7	8	9
N7:0	0	2	12	100	0	0	0	0	0	0

7-word message control block: N7:0 through N7:6

- N7:0 = 0 message status
- N7:1 = 2 DTAM node address
- N7:2 = 12 message length
- N7:3 = 100 offset (overwrite capability)

N7:4 through N7:6 = unused

Below is the data monitor display for the message local source file, followed by an explanation of the data file.

Address	0	1	2	3	4	5	6	7	8	9					
N10:0	E	n	t	e	r	N	e	w	V	a	l	u	e?	7	10
N10:10	20	0	0	0	0	0	0	0	0	0	0	0	0	0	

For ease of viewing, N10:0 through N10:7 are displayed in the ASCII radix. The rest of the file is displayed in Decimal.

12-word local source file: N10:0 through N10:11

- N10:0 through N10:7 8-word message text
- N10:8 through N10:11 data entry destination address

In this example the data entry destination address is N10:20. Memory locations N10:8 through N10:11 are assigned as follows:

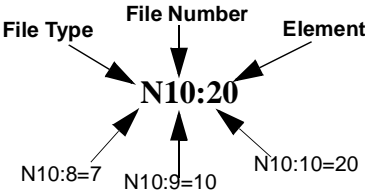

The following example is for the 1-word message in rung 2:

Read/Write:	WRITE	ignore if timed out:	0	TO
Target Device:	485 CIF	to be retried:	0	NR
Control Block:	N7:10	awaiting execution:	0	EW
Local Source File Address:	N7:20		0	
Target Node:	2	error:	0	ER
Target Offset:	100	message done:	0	DN
Message Length in elements:	1	message transmitting:	0	ST

Below is the data monitor display for the message control block and the local source file, followed by an explanation of the data file.

Address	0	1	2	3	4	5	6	7	8	9
N7:10	0	2	1	100	0	0	0	0	0	0
N7:20	0	0	0	0	0	0	0	0	0	0

7-word control block: N7:10 through N7:16

N7:10 = 0 message status

N7:11 = 2 DTAM node address

N7:12 = 1 message length

N7:13 = 100 offset (overwrite capability)

N7:14 through N7:16 = unused

1-word local source file: N7:20

The ladder logic and data monitor examples on the previous pages must be programmed in SLC 5/02 processor memory for the following module message display:

1. When the input in rung 0 becomes true, the module displays this message:

ENTER NEW VALUE?
0

2. To enter a value use the numeric keys. Then:
Press **[ENTER]**.
3. The value writes to the data entry destination address, and the module display returns to the previous screen.
If no value is entered, the value in the data entry destination address remains unchanged, and the display returns to the previous screen after five seconds.
Pressing the **[ESC]** key while the message is displayed does not alter the value stored at the data entry address, and the display returns to the previous screen.

Troubleshooting

This chapter describes the most common troubleshooting procedures. It describes:

- troubleshooting module problems using the Communications LED
- troubleshooting module problems using the module display
- troubleshooting communications problems using the module display
- troubleshooting function problems using the module display
- troubleshooting MSG instruction error codes
- troubleshooting processor faults using the module display

Troubleshooting Module Problems Using the Communications LED

Refer to the following log to determine the status of the LED indicators:



Indicates the LED is OFF.



Indicates the LED is ILLUMINATED RED.







Indicates the LED is FLASHING RED.







Indicates the LED is ILLUMINATED GREEN.



Indicates the LED is FLASHING GREEN.

TROUBLESHOOTING CONSIDERATIONS			
COMMUNICATIONS INDICATOR	DESCRIPTION	PROBABLE CAUSES	RECOMMENDED ACTION
 OFF	Module does not power up	Bad cable connection	<ol style="list-style-type: none"> 1. Verify proper connections on the module. 2. Verify proper connections to processor or link coupler. 3. Replace 1747-C10 Cable.
		Power supply overloaded	Evaluate chassis backplane loading for proper sizing of power supply.
		No power to link coupler if on DH485 network	If no processor is connected to link coupler, provide 190mA or 24 VDC to screw terminals on link coupler.
		Defective chassis power supply	<ol style="list-style-type: none"> 1. Check for proper power supply connections. 2. Check for proper power supply voltage. 3. Replace power supply. 4. Disconnect module. Call your Allen-Bradley service representative.
 ILLUMINATED RED	During power up	Normal	None.
	During self diagnostics	Normal	None.
	Hardware malfunction	Defective power supply	<ol style="list-style-type: none"> 1. Check for proper power supply voltage. 2. Replace power supply. 3. Disconnect module. Call your Allen-Bradley service representative.
	Software malfunction	Diagnostic failure	<ol style="list-style-type: none"> 1. Consult error code on module display. 2. Reset module. 3. Cycle power to module.
 FLASHING RED	Illegal network connection	Improper module setup configuration	Refer to module display.
 ILLUMINATED GREEN	Communicating on network	Module configured for Monitor mode	None.
 FLASHING GREEN	Communicating on network	Module configured for Modify mode	None.
		Data being entered in Monitor Override mode	None.

Troubleshooting Module Problems Using the LCD

TROUBLESHOOTING CONSIDERATIONS			
MODULE DISPLAY	COMM LED	PROBABLE CAUSES	RECOMMENDED ACTION
 ERROR 100	LED illuminated red	ROM memory failed checksum test	Reset module.
 ERROR 200	LED illuminated red	RAM failed Read/Write test	Reset module.
 ERROR 300	LED illuminated red	Keypad malfunction	Reset module.
 ERROR 400	LED illuminated red	Configuration memory failed checksum test	1. Cycle module power. 2. Reconfigure module. Refer to chapter 3, <i>Module Setup Procedure</i> .
Backlighting off	LED illuminated red	Insufficient power supply voltage	Check power supply.
Backlighting flashes on and off	LED illuminated red	Insufficient or unregulated power supply voltage	Check power supply.
LCD background is solid black	Any	Enclosure is too hot	1. Adjust display contrast, turn pot clockwise. 2. Operate within temperature specifications.
LCD characters are out of line	Any	Enclosure is too hot or module is exposed to sudden temperature change.	Allow temperature to stabilize.
LCD is difficult to read	Any	Backlighting was Turned Off	Reconfigure module. Refer to chapter 3, <i>Module Setup Procedure</i> .
LCD characters unintelligible	Any	Water contamination in module	Correct condition.
		Improper initialization	Reset module.
		Module Cconfigured for a foreign language	Reconfigure module. Refer to chapter 3, <i>Module Setup Procedure</i> .
LCD appears faded or no display at all	Any	Enclosure too cold	Adjust display contrast, turn pot counter clockwise.
		Module subjected to excessive heat or humidity	Disconnect module. Contact your local Allen-Bradley representative.

Troubleshooting Communication Problems Using the LCD

TROUBLESHOOTING CONSIDERATIONS

GENERAL ERROR SCREEN	ATTEMPTED FUNCTION	PROBABLE CAUSES	RECOMMENDED ACTION
	Attach to node	Illegal node address entered	Node address must be within the range of 0 through 31.
	Change processor to Run mode	Module not attached to node	Attach to proper node address.
		Module not in Modify mode	Change module to Modify mode.
	Display fault	Module not attached to node	Attach to proper node address.
	Clear fault	Module not attached to node	Attach to proper node address.
		Module not in modify node	Change module to Modify mode.
	Change processor to Program mode	Module not attached to node	Attach to proper node address.
		Module not in Modify mode	Change module to Modify mode.
	EEPROM to RAM memory transfer	Module not attached to node	Attach to proper node address.
		Module not in Modify mode	Change module to Modify mode.
		Processor in Run or Test mode	Change processor to Program mode.
	RAM to EEPROM memory transfer	Module not attached to node	Attach to proper node address.
		Module not in Modify mode	Change module to Modify mode.
		Processor in Run, Test or Fault mode	Change processor to Program mode or clear fault.
		Processor contains no user program	Download a user program to processor from a programming device or HHT.

TROUBLESHOOTING CONSIDERATIONS			
GENERAL ERROR SCREEN	ATTEMPTED FUNCTION	PROBABLE CAUSES	RECOMMENDED ACTION
	Use a Quick Recall Function	Quick recall function not defined	Assign an address to that function.
		Quick recall function defined but that address is not defined in this processor	Attach to proper node address.
	Enter Setup Procedure	Module not in Modify mode	Change module to Modify mode.
	Enter Password	Incorrect password entered	Enter correct password.
	Data Address Entry	Incorrect format for address	Reenter address correctly.
		Address not defined in this processor	Allocate address in memory.
	Data entry	Module in the Monitor mode	Change module to Modify mode.
		Value out of range for file type	Enter value within range.
		Address is read only (input or output file)	Abort entry.
	No response to a function key	Address entry in progress	Complete address entry or press the [ESC] key.
Data entry in progress		Complete data entry or press the [ESC] key.	
Illegal Command	Responding to a message	The Data file that the DTAM is trying to write to does not exist	See your software user manual for information on how to create the data entry destination or acknowledge bit locations.
	Attach to a 5/03 processor	The firmware in the DTAM is less than revision 3.0 and does not support 5/03 communications	Verify the firmware revision number on the DTAM nameplate, and contact your local Allen-Bradley sales office for an upgrade.
Incompat Program	Attach to a processor	The user program in the 5/03 processor is not supported by DTAM	Abort. Contact your local Allen-Bradley sales office.
Illegal Network	LED flashing red	No other nodes are active on the network	Attach the required processor to the network.
		One or more nodes on the network have an incorrect baud rate	Correct the baud rates.
		Network is shorted or improperly wired	Check network cable connections.
		Module has same node address as a 5/01 or fixed controller (point-to-point connection)	Reconfigure the module node address, refer to chapter 3, <i>Module Setup Procedure</i> .
		The maximum node address of the previous node is lower than the module address	Change the maximum node address of the previous node.
Duplicate Node	LED flashing red	Module has same node address as a 5/02 or 5/03 (point-to-point connection)	Change the module node address.
	LED flashing red	Module has same node address as another node (DH485 network connection)	Change the module node address.
No Response	LED illuminated green or flashing green	The node that the module is attached to has too many other nodes trying to communicate with it	Decrease the network traffic to the desired node address.

TROUBLESHOOTING CONSIDERATIONS			
GENERAL ERROR SCREEN	COMM LED	PROBABLE CAUSES	RECOMMENDED ACTION
XX is inactive ¹	LED illuminated green or flashing green	The processor at that node address is not powered up	Power up the processor.
		The processor at that node address is disconnected from the network	Activate that processor on the network.
		A fault has caused that processor node address to change to a default of one	Change the processor node address.
		The processor is set at the wrong baud rate	Change the processor baud rate.
XX is not a CPU ^a	LED illuminated green or flashing green	The node address you are attempting to attach to is a programming device or another DTAM	Abort.
		A programming device has been connected to the network with the same node address as a processor	Change the node address of the programming device.
XX not supported ^a	LED illuminated green or flashing green	The node address you are attempting to attach to is a non-supported device	Abort. Contact your local Allen-Bradley sales office.

1. Where XX is the Node Address Value.

Troubleshooting Function Problems Using the LCD

TROUBLESHOOTING CONSIDERATIONS			
GENERAL ERROR SCREEN	COMM LED	PROBABLE CAUSES	RECOMMENDED ACTION
Function Failed	LED illuminated green or flashing green	An incorrect password has been entered three times	Start a new attach procedure with the correct password.
XX owned by: XX ¹	LED illuminated green or flashing green	The node you wish to attach to is communicating with another node	Wait until the communications are complete or cancel the communications from one of the other devices.
Program Changed	LED illuminated green or flashing green	User program in the processor you are attached to has been changed by a programming device	Initiate a new attach sequence or press [ESC] if auto attach is set on.
Default	LED illuminated green or flashing green	Processor contains no user program	Download a user program to the processor from a programming device or HHT.
No Memory Module	LED illuminated green or flashing green	Trying to do a memory transfer function with no EEPROM installed in the processor	Install an EEPROM Module in the processor.
Access Denied	LED illuminated green or flashing green	Processor is owned by another node or HHT	Wait until communications are complete or cancel the ownership of the other device.
		The data entry destination address word in a 13- or 18-word message format is invalid or not allocated in the processor	Allocate the required address in the processor data file, then save and download the program. Check the data entry destination address.
		The acknowledge/no-acknowledge bit address in an 18-word message format is invalid or not allocated in the processor	Allocate the required address in the processor data file, then save and download the program. Check the acknowledge/no-acknowledge bits.
		The user program in a SLC 5/02 processor is compiled with all data files protected	Remove the file protection in the processor, then save and download the program.
		The keyswitch for a SLC 5/03 processor is not in the correct position	Set the keyswitch to REM position.

1. Where XX is the Node Address Value.

Troubleshooting MSG Instruction Error Codes

When an error condition occurs with a Message Instruction (MSG), the error code and its description are indicated in the Data Monitor display.

INSTRUCTION ERRORS	
Error Code	Fault Description
02H	Target node is busy. The MSG instruction will automatically reload. If other messages are waiting, the message is placed at the bottom of the stack.
03H	Target node cannot respond because message is too large.
04H	Target node cannot respond because it does not understand the command parameters OR the control block may have been inadvertently modified.
05H	Local processor is offline (possible duplicate node situation).
06H	Target node cannot respond because requested function is not available.
07H	Target node does not respond.
08H	Target node cannot respond.
09H	Local modem connection has been lost.
10H	Target node cannot respond because of incorrect command parameters or unsupported command.
11H	Local file has constant file protection.
12H	Local channel configuration protocol error exists.
13H	Local MSG configuration error in the Remote MSG parameters.
14H	Local communication driver is incompatible with the MSG instruction.
15H	Local channel configuration parameter error exists.
16H	Target or Local Bridge address is higher than the maximum node address.
17H	Local service is not supported.
18H	Broadcast (Node Address 155) is not supported.
19H	Improperly formatted Logical ASCII Address string. String not properly terminated with a NULL character or the string length does not match the value in the length parameter.
20H	PCCC Description: Host has a problem and will not communicate.
30H	PCCC Description: Remote station host is not there, disconnected, or shut down.
37H	Message timed out in local processor.
38H	Message disabled pending link response.
40H	PCCC Description: Host could not complete function due to hardware fault.
50H	Target node is out of memory.
60H	Target node cannot respond because file is protected.
70H	PCCC Description: Processor is in Program mode.
80H	PCCC Description: Compatibility mode file missing or communication zone problem.
90H	PCCC Description: Remote station cannot buffer command.
B0H	PCCC Description: Remote station problem due to download.
C0H	PCCC Description: Cannot execute command due to active IPBs.
D0H	No IP address configured for the network, -or- Bad command – unsolicited message error, -or- Bad address – unsolicited message error, -or- No privilege – unsolicited message error.

D1H	Maximum connections used – no connections available.
D2H	Invalid internet address or host name.
D3H	No such host / Cannot communicate with the name server.
D4H	Connection not completed before user-spcified timeout.
D5H	Connection timed out by the network.
D7H	Connection refused by destination host.
D8H	Connection was broken.
D9H	Reply not received before user-specified timeout.
DAH	No network buffer space available.
E1H	PCCC Description: Illegal Address Format, a field has an illegal value.
E2H	PCCC Description: Illegal Address Format, not enough fields specified.
E3H	PCCC Description: Illegal Address Format, too many fields specified.
E4H	PCCC Description:Illegal Address Format, symbol not found.
E5H	PCCC Description: Illegal Address Format, symbol is 0 or greater than the maximum number of characters supported by this device.
E6H	PCCC Description: Illegal Address, address does not exist, or does not point to something usable by this command.
E7H	Target node cannot respond because length requested is too large.
E8H	PCCC Description: Cannot complete request, situation changed (file size, for example) during multi-packet operation.
E9H	PCCC Description: Data or file is too large.
EAH	PCCC Description: Request is too large; transaction size plus word address is too large.
EBH	Target node cannot respond because target node denies access.
ECH	Target node cannot respond because requested function is currently unavailable.
EDH	PCCC Description: Resource is already available; condition already exists.
EEH	PCCC Description: Command cannot be executed.
EFH	PCCC Description: Overflow; histogram overflow.
F0H	PCCC Description: No access.
F1H	Local processor detects illegal target file type.
F2H	PCCC Description: Invalid parameter; invalid data in search or command block.
F3H	PCCC Description: Address reference exists to deleted area.
F4H	PCCC Description: Command execution failure for unknown reason; PLC-3 histogram overflow.
F5H	PCCC Description: Data conversion error.
F6H	PCCC Description: The scanner is not able to communicate with a 1771 rack adapter. This could be due to the scanner not scanning, the selected adapter not responding, or an invalid request of a "DCM BT (block transfer)".
F7H	PCCC Description: The adapter is not able to communicate with a module.
F8H	PCCC Description: The 1771 module response was not valid – size, checksum, etc.
F9H	PCCC Description: Duplicate label.
FAH	Target node cannot respond because another node is file owner (has sole file access).
FBH	Target node cannot respond because another node is program owner (has sole access to all files).

FCH	PCCC Description: Disk file is write-protected or otherwise inaccessible (off-line only).
FDH	PCCC Description: Disk file is being used by another application; update not performed (off-line only).
FFH	Local communication channel is shut down.
0AH	Buffer unavailable to receive SRD reply.
0BH	Target node does not accept this type of MSG instruction.
0CH	Received a master link reset (one possible source is from the DF1 master).

Troubleshooting Processor Faults Using the LCD

If you are attached to a processor when a fault occurs, the module displays a fault code, in hexadecimal format, and a description of the fault. You may also attach to a faulted processor to view the source of a fault. The tables below describe the possible fault conditions in SLC 500 family processors.

The characters xx in the following codes represent the slot number, in hex. The characters xx become 1F if the exact slot can not be determined.

Slot Numbers in Hexadecimal

Slot	XX	Slot	XX	Slot	XX
0	00	11	0B	22	16
1	01	12	0C	23	17
2	02	13	0D	24	18
3	03	14	0E	25	19
4	04	15	0F	26	1A
5	05	16	10	27	1B
6	06	17	11	28	1C
7	07	18	12	29	1D
8	08	19	13	30	1E
9	09	20	14		
10	0A	21	15		

PROCESSOR ERRORS

Error Code	Module Display	Fault Description
0000	NO FAULT	You have attempted to view a fault in a non-faulted processor.
0001	CORRUPT NVRAM	NVRAM error.
0002	HARDWARE TIMEOUT	Unexpected hardware watchdog timeout.
0003	AUTOLOAD FAILED	Memory module memory error. This error can also occur when going to the REM Run mode.
0007 ¹	TRANSFER FAILED	Failure during memory module transfer of autoloader.
0008 ¹	CPU SOFTWARE ERR	Internal software error.
0009 ¹	CPU HARDWARE ERR	Internal hardware error.
0010	WRONG PROC. REV.	The processor does not meet the proper revision level.
0011	FILE 2 MISSING	The executable program file number 2 is absent.
0012	PROG MEM. ERROR	The ladder program has a memory error.
0013	MEM MOD MISSING	The required memory module is absent or either S:1/10 or S:1/11 is not set as required by the program.
0014	INT. FILE ERROR	Internal file error.
0015	CFG. FILE ERROR	Configuration file error.

1. Error codes for 5/03 processor only

PROCESSOR ERRORS		
Error Code	Module Display	Fault Description
0016	START AFTER P.F.	Startup protection after power loss. Error condition exists at powerup when bit S:1/9 is set and powerdown occurred while running.
0017 ¹	PRC/MMOD MISMATCH	NVRAM/memory module mismatch.
001F ¹	BAD ONLINE EDIT	A program integrity problem occurred during an online editing session.
0020	MINOR ERR AT END	A minor error bit is set at the end of the scan.
0021	REM. POWER FAIL	A remote power failure of an expansion I/O rack has occurred.
0022	WATCHDOG TIMEOUT	The user watchdog scan time has been exceeded.
0023	INVALID STI FILE	Invalid or non-existent STI interrupt file.
0024	INVALID STI TIME	Invalid STI interrupt interval (greater than 2550 ms or negative).
0025	TOO MANY JSRs	Excessive stack depth/JSR calls for the STI routine.
0026	TOO MANY JSRs	Excessive stack depth/JSR calls for an I/O interrupt routine.
0027	TOO MANY JSRs	Excessive stack depth/JSR calls for the user fault routine.
0028	INVALID FLT FILE	Invalid or non-existent "startup protection" fault routine file value.
0029	INDEX TOO LARGE	Indexed address reference is outside of entire data file space (range of B3:0 through the last file).
002A	INDEX TOO LARGE	Indexed address reference is beyond specific referenced data file.
002B ¹	BAD INDRCT FILE	Invalid indirect address file number.
002C ¹	BAD INDRCT ELEM	Invalid indirect address element.
002D ¹	BAD INDRCT SUBEL	Invalid indirect address subelement.
002E ¹	INVALID DII SLOT	Invalid DII input slot.
002F ¹	INVALID DII FILE	Invalid or non-existent DII interrupt file.
0030	SUB NEST TOO DEEP	An attempt was made to jump to one too many nested subroutine files. This code can also mean that a program has potential recursive routines.
0031	UNSUPPORTED INST	An unsupported instruction reference was detected. Contact Allen-Bradley.

1. Error codes for 5/03 processor only

PROCESSOR ERRORS

Error Code	Module Display	Fault Description
0032	BAD SQC/SQO INST	A sequencer instruction length/position parameter points past the end of a data file.
0033	BAD BSL/BSR INST	The length parameter of an LFU, LFL, FFU, FFL, BSL or BSR points past the end of data file.
0034	BAD TIMER DATA	A negative value for a timer accumulator or preset value was detected.
0035	BAD INST IN INTR	TND, SVC or REF instruction is called within an interrupting or user fault routine.
0036	BAD PID PARAM	An invalid value is being used for a PID instruction parameter.
0038	RET IN FILE 2	A RET instruction was detected in a non-subroutine file.
xx39 ¹	BAD STxx:LEN	Invalid string length in string file.
xx50	SLOT xx DATA ERR	A rack data error is detected at the slot specified.
xx51	SLOT xx MOD ERROR	An I/O module runtime error at the slot specified.
xx52	SLOT xx MOD RMV	A module required for the user program is detected as missing or removed at the slot specified.
xx53	MOD IN SLOT xx	At going-to-run, a user program declares a slot as unused, and that slot is detected as having an I/O module inserted.
xx54	SLOT xx MISMATCH	A module required for the user program is detected as being the wrong type.
xx55	SLOT xx MOD ERR	A module required for the user program is detected as having the wrong I/O count or wrong I/O driver.
0056	SLOT 00 BAD CFG	The rack configuration specified in the user program is incorrect.
xx57	SLOT xx COMM ERR	An intelligent I/O module has not responded to a Lock Shared Memory command within the required limit.
xx58	SLOT xx SI/O ERR	A specialty I/O module generated a generic fault.
xx59	SLOTxx SI/O ERR	An intelligent I/O module has not responded to a command as being completed within the required time limit.
xx5A	SLOT xx SI/O ERR	Hardware interrupt problem at the specified slot.

1. Error codes for 5/03 processor only

PROCESSOR ERRORS		
Error Code	Module Display	Fault Description
xx5B	SLOT xx BAD CFG	G file configuration error – User program G file size exceeds the capacity of the module.
xx5C	SLOT xx BAD CFG	M0-M1 file configuration error – User program M0-M1 file size exceeds the capacity of the module.
xx5D	SLOT xx SI/O ERR	Interrupt service requested is not supported by the processor.
xx5E	SLOT xx SI/O ERR	Processor I/O driver (software) error.
xx60 thru xx6F	SLOT xx SI/O ERR	Identifies an I/O card specific recoverable major error. Refer to the user information supplied with the card for further details.
xx70 thru xx7F	SLOT xx SI/O ERR	Identifies an I/O card specific non-recoverable major error. Refer to the user information supplied with the card for further details.
xx80 thru xx8F	SLOT xx SI/O ERR	Identifies an I/O card specific non-recoverable major error. Refer to the user information supplied with the card for further details.
xx90	SLOT xx MOD ERROR	Interrupt problem at the specified disabled slot.
xx91	SLOT xx MOD ERROR	The specified disabled slot has faulted.
xx92	SLOT xx INT ERROR	Invalid or non-existent module interrupt.
xx93	SLOT xx MOD ERROR	Unsupported I/O module specific major error.
xx94	MOD IN SLOT xx	In the processor run or test mode, a module has been detected as being inserted under power. Code xx94 also can mean that an I/O module reset itself.

Specifications

This appendix contains the module's specifications for:

- operating power
- temperature and humidity
- general characteristics

Operating Power

Input Line Voltage	18 to 30 V dc
Input Current	104 mA (max) at 24 VDC
Input Volts (ripple)	1V p-p
Input Current Inrush	350 mA pk (max)

Temperature and Humidity

Operating Temperature	0 to 55°C (+32 to +131°F)
Storage Temperature	-20 to +65°C (-4 to +149°F)
Humidity Rating	<p>5 to 95% (without condensation)</p> <p>IMPORTANT: Due to the physical properties of Liquid Crystal Displays, it is important that the following temperature/humidity ratings be considered maximums to prevent premature degradation of display quality:</p> <p><u>Temperature Humidity</u> 35°C (95°F) 95% RH 45°C (113°F) 85% RH 55°C (131°F) 75% RH</p>

General Characteristics

Physical Dimensions	<ul style="list-style-type: none"> • Front Panel: 152.4 mm H x 139.7 mm W (6.0 in H x 5.5 in W) • Back Case: 127.0 mm H x 101.6 mm W x 63.5 mm D (5.0 in H x 4.0 in W x 2.5 in D)
Mounting Torques	.8 Nm (7.0 in-lb)
Operating Modes	The module can operate in one of two modes, Monitor or Modify. There is a three position terminal block provided for mode change. Access to the terminal is provided through the back case.
Display	The display is liquid crystal, using supertwist nematic fluid. The display format is 16 characters by 2 lines. A trim pot is provided for contrast adjustment. LCD backlighting is provided for viewing in low light conditions.
Keypad	The keypad is of sealed membrane construction. The keys have an embossed rim and tactile feedback.
Status Indicator	A bi-color LED is provided on the front of the module to provide communications and fault status.
Interconnect Cable	The standard 1747-C10 cable is used as the interconnector between the module and a SLC 500 family processor or a DH-485 link coupler.
Vibration	0.38 mm (0.015 in) peak to peak displacement 2.5 g peak (max) acceleration 1 hr/axis
Noise Immunity	Meets NEMA standard ICS 2-230
Certification	UL listed. CSA certified. Class I, Division 2, Groups A, B, C, D Meets NEMA 12 and 13 enclosure applications CE compliant for all applicable directives

SLC 500 Data Files and Logical Addressing

This appendix provides you with an overview of SLC 500 family data files and logical addressing. It describes:

- data files
- data file types
- data file addressing

Data Files

Data files contain the status information associated with external I/O and all other instructions you use in your program. In addition, these files store information concerning processor operation.

Data File Types

For the purposes of addressing, each file type is identified by a letter (identifier) and a file number.

File numbers 0 through 7 are the default files, created for you. If you need additional storage, you can create files by specifying the appropriate identifier and a file number from 10 to 255. This applies to Bit, Timer, Counter, Control, and Integer files only. Refer to the tables on the following page.

Data Files				
0	Output Image	File Type	Identifier	File Number
1	Input Image	Output	O	0
2	Status	Input	I	1
3	Bit	Status ^a	S	2
4	Timer	Bit	B	3
5	Counter	Timer	T	4
6	Control	Counter	C	5
7	Integer	Control	R	6
8	Reserved	Integer	N	7
9	Reserved	^a Not accessible from the DTAM		
10-255	Bit, Timer, Counter, Control, or Integer, assigned as needed	User-Defined Files		
		File Type	Identifier	File Number
		Bit	B	10-255
		Timer	T	
		Counter	C	
		Control	R	
		Integer	N	

Address Structure

Data files contain elements. Some data files have 1-word elements, some have 3-word elements. You will be addressing elements, words, and bits.

Addresses are made up of alpha-numeric characters separated by delimiters. Delimiters include the colon, slash, and period.

Typical element, word, and bit addresses are shown below.

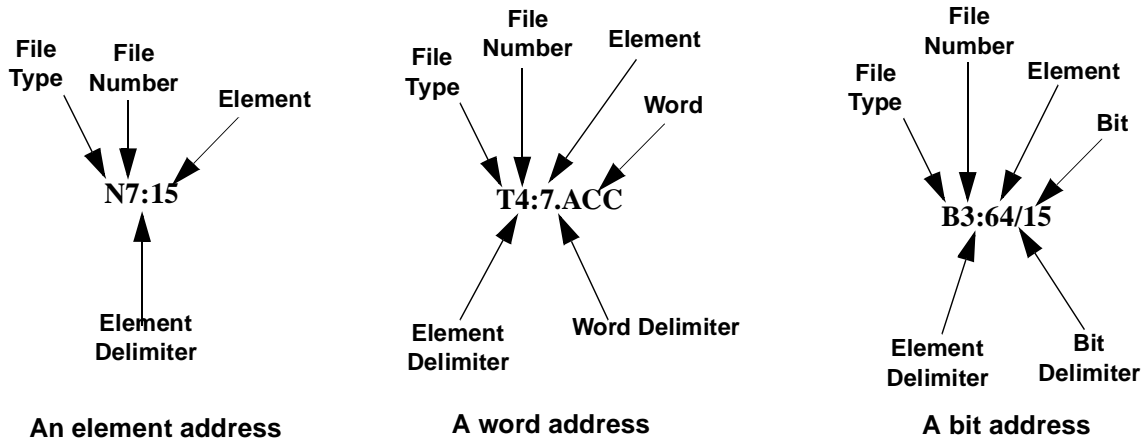

The address format varies, depending on the file type. This is explained in the following sections. We begin with file 0 and 1, outputs and inputs, and follow with files 3, 4, 5, 6, and 7.

Data Files 0 and 1 - Outputs and Inputs

Bits in file 0 are used to represent external outputs. Bits in file 1 are used to represent external inputs. In most cases, a single 16-bit word in these files will correspond to a slot location in your controller, with bit numbers corresponding to input or output terminal numbers.

The tables on the following pages describe the I/O addressing methods for both fixed and modular controllers.

I/O addresses are assigned to fixed I/O controllers as shown below.

Format	Explanation		
O:e.s/b I:e.s/b	O	Output	
	I	Input	
	:	Element delimiter	
	e	Slot number (decimal)	fixed I/O controller: 0
			left slot of expansion rack: 1 right slot of expansion rack: 2
	.	Word delimiter.	Required only if a word number is necessary as noted below.
	s	Word number	Required if the number of inputs or outputs exceeds 16 for the slot. Range: 0-255 (range accommodates multi-word specialty I/O modules).
	/	Bit delimiter	
b	Terminal number	Inputs: 0 to 15 (or 0 to 23, slot 0) Outputs: 0 to 15	
<p>Examples:</p> <p>O:0/4 Controller Output (slot 4)</p> <p>O:2/7 Output 7, slot 2 of an expansion rack</p> <p>I:1/4 Input 4, slot 1 of an expansion rack</p> <p>I:0/15 Controller input 15 (slot 0)</p> <p>I:0.1/17 Controller input 23 (bit 07, word 1 of slot 0)</p> <p>Alternate way of addressing I/O terminals 16 and higher: As indicated above, address I:0.1/7 applies to input terminal 23 of slot 0. You can also address this terminal as I:0/23</p> <p>Word Addresses</p> <p>O:1 Output word 0, slot 1</p> <p>I:0 Input word 0, slot 0</p> <p>I:0.1 Input word 1, slot 0</p>			

I/O addresses are assigned to modular controllers as shown in the table below:

Format	Explanation		
O:e.s/b I:e.s/b	O	Output	
	I	Input	
	:	Element delimiter	
	e	Slot number (decimal)	Slot 0, adjacent to the power supply in the first rack, applies to the processor module (CPU). Succeeding slots are I/O slots, numbered from 1 to a maximum of 30.
	.	Word delimiter.	Required only if a word number is necessary as noted below.
	s	Word number	Required if the number of inputs or outputs exceeds 16 for the slot. Range: 0-255 (range accommodates multi-word specialty I/O modules).
	/	Bit delimiter	
	b	Terminal number	Inputs: 0 to 15 Outputs: 0 to 15
<p>Examples:</p> <p>O:3/15 Output 15, slot 3 O:5/0 Output 0, slot 5 O:10/11 Output 11, slot 10 I:7/8 Input 8, slot 7 I:2.1/3 Input 3, slot 2, word 1</p> <p>Word Addresses</p> <p>O:5 Output word 0, slot 5 O:5.1 Input word 1, slot 5 I:8 Input word 0, slot 8</p>			

Data File 3 - Bit

File 3 is the bit file, used principally for relay logic instructions, shift registers, and sequencers. The maximum size of the file is 256 1-word elements, or a total of 4096 bits. You can address bits by specifying the element number (0-255) and the bit number within the element (0-15). You can also address bits simply by numbering them in sequence, from 0 to 4095.

You can also address elements of this file.

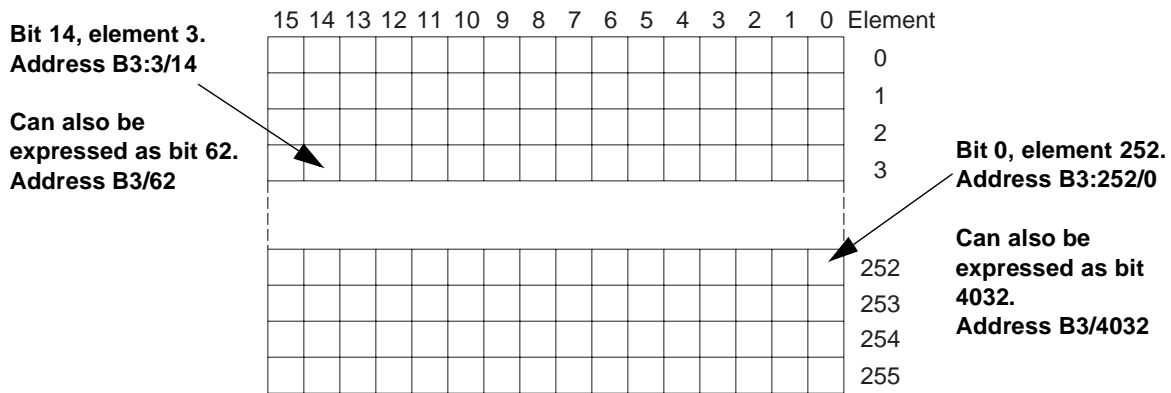

Format	Explanation		Examples	
Bf:e/b	B	Bit type file	B3:3/14 Bit 14, element 03 B3:252/0 Bit 0, element 252 B3:9 Bit 0-15, element 9	
	f	File number.		Number 3 is the default file. A file number between 10-255 can be used if additional storage is required.
	:	Element delimiter		
	e	Element number		Ranges from 0 to 255. These are 1-word elements. 16-bits per element.
	/	Bit delimiter.		
	b	Bit number		Bit location within the element. Ranges from 1 to 15.
Bf/b	B f /	Same as above.		
	b	Bit number	This is the numerical position of the bit within the file. Ranges from 0 to 4095.	

Data File 4 - Timers

Timers are 3-word elements. Word 0 is the control word, word 1 stores the preset value, and word 2 stores the accumulator value. This is illustrated below.

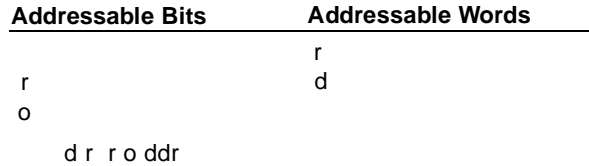
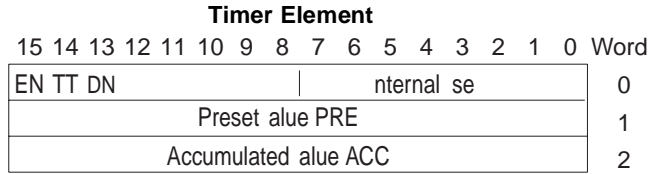

Assign timer addresses as follows:

Format	Explanation	
Tf:e	T	Timer
	f	File number. Number 4 is the default file. A file number between 10-255 can be used if additional storage is required.
	:	Element delimiter
	e	Element number. Ranges from 0 to 255. These are 3-word elements. See the figure above.
<p>Examples: T4:0 Element 0, timer file 4.</p> <p>Address bits and words by using the format TF:e.s/b where Tf:e is explained above, and</p> <ul style="list-style-type: none"> . is the word delimiter s indicates subelement / is the bit delimiter b indicates bit <p style="margin-left: 40px;"> T4:0/15 Enable bit T4:0/14 Timer timing bit T4:0/13 Done bit T4:0.1 Preset value of the timer T4:0.2 Accumulated value of the timer T4:0.1/0 Bit 0 of the preset value T4:0.2/0 Bit 0 of the accumulated value </p>		

Data File 5 - Counters

Counters are 3-word elements. Word 0 is the control word, word 1 stores the preset value, and word 2 stores the accumulator value. This is illustrated below.

Counter Element																Word	
15	14	13	12	11	10	9	8	7	6	5	4	3	2	1	0		
CU	CD	DN	O	UN	UA											Internal Use	0
Preset value PRE																1	
Accumulated value ACC																2	

Addressable Bits	Addressable Words
o	r
o do	d
o	
ro	d r
dro	r o ddr
d or	
o	

Assign counter addresses as follows:

Format	Explanation	
Cf:e	C	Counter
	f	File number. Number 5 is the default file. A file number between 10-255 can be used if additional storage is required.
	:	Element delimiter
	e	Element number. Ranges from 0 to 255. These are 3-word elements. See the figure above.
Examples:	C5:0	Element 0, counter file 5.
Address bits and words by using the format CF:e.s/b where Cf:e is explained above, and		
. is the word delimiter s indicates subelement / is the bit delimiter b indicates bit		
C5:0/15	Count Up Enable	
C5:0/14	Count Down Enable	
C5:0/13	Done bit	
C5:0/12	Overflow bit	
C5:0/11	Underflow bit	
C5:0/10	Update accumulator bit (HSC only)	
C5:0.1	Preset value of the counter	
C5:0.2	Accumulated value of the counter	
C5:0.1/0	Bit 0 of the preset value	
C5:0.2/0	Bit 0 of the accumulated value	

Data File 6 - Control

These are 3-word elements, used with Bit Shift and Sequencer instructions. Word 0 is the status word, word 1 indicates the length of stored data, and word 2 indicates position. This is illustrated below.

Control Element															Word	
15	14	13	12	11	10	9	8	7	6	5	4	3	2	1	0	
EN	DN	ER	UL	IN	FD	Internal Use									0	
Length of Bit array or File																1
Bit Pointer or Position																2

Addressable Bits	Addressable Words
o	oo
rror	
od o	d r
od	r o ddr

Assign control addresses as follows:

Format	Explanation	
Rf:e	R	Control
	f	File number. Number 6 is the default file. A file number between 10-255 can be used if additional storage is required.
	:	Element delimiter
	e	Element number. Ranges from 0 to 255. These are 3-word elements. See the figure above.
Examples:	R6:2	Element 2, control file 6.
Address bits and words by using the format RF:e.s/b where Rf:e is explained above, and		
. is the word delimiter s indicates subelement / is the bit delimiter b indicates bit		
R6:2/15	Enable bit	
R6:2/13	Done bit	
R6:2/11	Error bit	
R6:2/10	Unload bit	
R6:2/9	Inhibit bit	
R6:2/8	Found bit	
R6:2.1	Length value	
R6:2.2	Position value	
R6:2.1/0	Bit 0 of the length value	
R6:2.2/0	Bit 0 of the position value	

Data File 7- Integer

These are 1-word elements, addressable at the element and bit level. The Data Table Access Module cannot access Integer words to the bit level.

Integer File

15	14	13	12	11	10	9	8	7	6	5	4	3	2	1	0	Element
																0
																1
																2
																253
																254
																255

Assign integer addresses as follows:

Format	Explanation	
Nf:e	N	Integer
	f	File number. Number 7 is the default file. A file number between 10-255 can be used if additional storage is required.
	:	Element delimiter
	e	Element number. Ranges from 0 to 255. These are 1-word elements. 16 bits per element.
	/	Bit delimiter
	b	Bit number. Bit location within the element. Ranges from 0 to 15.
Examples:	N7:2	Element 2, integer file 7.
	N7:2/8	Bit 8 in element 2, integer file 7.
	N10:36	Element 36, integer file 10 (file designated as an integer file by the user)

Module Display Character Set

Display Character Table

This appendix provides a table to describe the module display characters and their binary equivalents. 00 through 1F Hex are reserved for system use.

Example: 41H = 0100001B = A

Low Order 4 bit Hex	High Order 4 bit Binary	Hex Binary	2x	3x	4x	5x	6x	7x	Ax	Bx	Cx	Dx	Ex	Fx
			0010	0011	0100	0101	0110	0111	1010	1011	1100	1101	1110	1111
y0	0000		0	1	2	3	4	5	6	7	8	9	A	B
y1	0001	!	1	A	Q	a	q	2	7	4	3	9		
y2	0010	"	2	R	b	r	"	4	7	x	p	0		
y3	0011	#	3	S	s	3	7	e						
y4	0100	\$	4	T	t	4	7	l	h	u	0			
y5	0101	%	5	E	e	u	5	7	1	5	0			
y6	0110	&	6	F	f	v	7	h	2	3	p	2		
y7	0111	'	7	G	g	w	7	7	7	9	π			
y8	1000	<	8	H	h	x	4	7	7	7	7	7		
y9	1001	>	9	I	i	y	6	7	7	7	7	7		
yA	1010	*	:	J	j	z	z	z	z	z	z	z		
yB	1011	+	:	K	k	<	*	7	7	7	7	7		
yC	1100	,	<	L	l	7	7	7	7	7	7	7		
yD	1101	-	=	M	m	>	7	7	7	7	7	7		
yE	1110	.	>	N	n	7	7	7	7	7	7	7		
yF	1111	/	?	O	o	7	7	7	7	7	7	7		

Mounting Template

We have provided the following full-size template for your convenience in mounting the Data Table Access Module.

Using the Template

Before you use this template, read the installation recommendations on page 2-1.

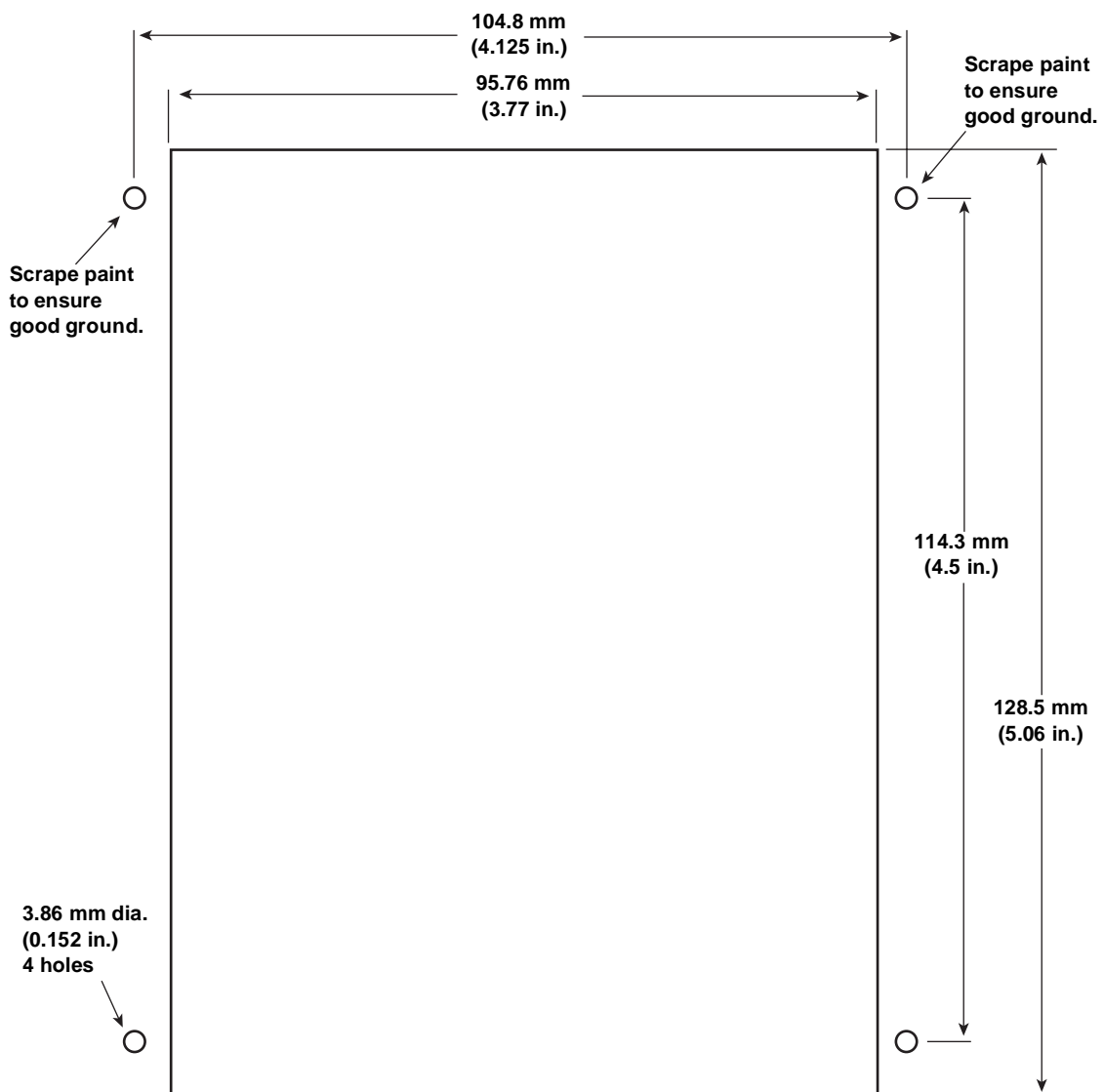

Symbols

.ACC	5-4
.LEN	5-4
.POS	5-4
.PRE	5-4

Numerics

12-word message	
application example	8-19
1747 AIC+	2-5
1747-AIC	2-5
1747-C10	2-5
1747-C-11	2-5
18-word message	
application example	8-13
1-word message	
application example	8-20
8-word message	
application example	8-15

A

access denied	9-7
access hole	
making adjustments through	2-6
access port	
making adjustments through	2-6
addressing	
changing the node address	4-2
data file address structure	B-2
adjustments	
monitor mode	2-6
ASCII characters	C-1

B

Backspace Function	
during data file value entry	5-14
bit addresses	
address format	B-5
entering	5-7
bit status	
changing at bit level	5-16
changing at word level	5-15

C

cables	
communication	2-5
interconnect	2-5
character display	C-1
clear message	
application example	8-20
communications LED	
state changes	5-2
configuration and adjustments	
monitor mode	2-6
connecting the equipment	2-4, 2-5
to a DH-485 network	2-4, 2-5
to a SLC 500 family processor	2-4

to an SLC 5/04 processor	2-5
contrast, LCD	
adjust pot.	2-6
adjusting	9-3
control addresses	
address format	B-8
entering	5-8
counter addresses	
address format	B-7
entering	5-7
current	
input	A-1
input inrush	A-1
cursor movement	
to the left	5-15
to the right	5-15
Cursor Right Function	
during binary data entry	5-15
implementing	5-15
Multiple Cursor Right	5-15
Single Cursor Right	5-15

D

data file values	
changing bit status at bit level	5-16
changing bit status at word level	5-15
changing the sign of a value	5-14
data files	
address structure	B-2
variations of	5-7
DEC key, explanation of	3-2
deleting strings	
.ACC	5-4
.LEN	5-4
.POS	5-4
.PRE	5-4
DH-485 network, connecting to	2-4, 2-5
dimensions, physical	A-2
displaying data file addresses	
different bit file addresses	5-12
different control bits within elements	5-11
different word addresses within elements	5-10
duplicate node error	9-5

E

equipment connection	2-4, 2-5
errors	
correcting	9-1
function failed	9-7
illegal command	9-5
illegal network	9-5
incompat program	9-5
no memory module	9-7
no response	9-5
program changed	9-7

F

function failed error	9-7
-----------------------------	-----

- G**
- grounding the module 2-2
- H**
- HALT 4-3
- Halt mode
Ready Attached screen display 4-3
- humidity rating A-1
- I**
- illegal command error 9-5
- illegal network error 9-5
- INC key, explanation of 3-2
- incompat program error 9-5
- input and output addresses
address format B-2
entering 5-7
- integer addresses
addresses format B-9
entering 5-8
- interconnect cable 2-5
- J**
- jumper
alternative to 2-7
configuring the module with 2-6
- K**
- keys, explanation of 3-1
- keyswitch
for 5/03 operating modes 4-3
mounting user-supplied 2-7
- L**
- LCD
contrast adjust pot. 2-6
contrast adjustment 9-3
- LED
state changes 5-2
- link coupler 2-5
- logical data file addressing
compared to quick access addressing . . . 5-6
- M**
- manuals, related P-3
- memory transfer
troubleshooting using the LCD 9-7
- modify mode 2-6
configuration and adjustments 2-6
functions performed 5-2
LED state 5-2
- module configuration and adjustments
monitor mode 2-6
- monitor mode 2-6
configuration and adjustments 2-6
functions performed 5-2
LED state 5-2
- Monitor Override
functions performed 5-2
LED state 5-2
- moving the cursor
to the left 5-15
to the right 5-15
- N**
- NEXT key, explanation of 3-2
- no memory module error 9-7
- no response error 9-5
- node address
changing 4-2
- noise immunity A-2
- O**
- operating modes
displayed on Ready Attached screen . . . 4-3
monitor mode 5-1
Monitor Override feature 5-1
- operating power
input current A-1
input current inrush A-1
input line voltage A-1
input volts (ripple) A-1
- output and input addresses
address format B-2
entering 5-7
- P**
- PREV key, explanation of 3-2
- PROG 4-3
- program changed error 9-7
- Program mode
Ready Attached screen display 4-3
- publications, related P-3
- Q**
- questions or comments on manual P-4
- quick access addressing
compared to logical addressing 5-6

R

- ready screens 3-7
 - Ready Attached screen
 - during Manual Attach procedure . . . 4-2
 - text, operating mode 4-3
 - Ready Unattached screen 3-3, 4-1
 - during Manual Attach procedure . . . 4-1
- REM position 4-3
- RHALT 4-3
- RRUN 4-3
- RTEST 4-3
- RUN 4-3
- Run mode
 - Ready Attached screen display 4-3

S

- setup mode
 - changing the setup configuration 3-3
- strain relief tab 2-2

T

- technical product assistance P-4
- temperature
 - operating A-1
 - storage A-1
- TEST 4-3
- timer addresses
 - address format B-6
 - entering 5-7
- torque 2-2, A-2

U

- user-supplied keyswitch
 - connecting 2-7

V

- volts
 - input (ripple) A-1
 - input line A-1



Rockwell Automation helps its customers receive a superior return on their investment by bringing together leading brands in industrial automation, creating a broad spectrum of easy-to-integrate products. These are supported by local technical resources available worldwide, a global network of system solutions providers, and the advanced technology resources of Rockwell.

Worldwide representation.



Argentina • Australia • Austria • Bahrain • Belgium • Bolivia • Brazil • Bulgaria • Canada • Chile • China, People's Republic of • Colombia • Costa Rica • Croatia • Cyprus • Czech Republic • Denmark • Dominican Republic • Ecuador • Egypt • El Salvador • Finland • France • Germany • Ghana • Greece • Guatemala • Honduras • Hong Kong • Hungary • Iceland • India • Indonesia • Iran • Ireland • Israel • Italy • Jamaica • Japan • Jordan • Korea • Kuwait • Lebanon • Macau • Malaysia • Malta • Mexico • Morocco • The Netherlands • New Zealand • Nigeria • Norway • Oman • Pakistan • Panama • Peru • Philippines • Poland • Portugal • Puerto Rico • Qatar • Romania • Russia • Saudi Arabia • Singapore • Slovakia • Slovenia • South Africa, Republic of • Spain • Sweden • Switzerland • Taiwan • Thailand • Trinidad • Tunisia • Turkey • United Arab Emirates • United Kingdom • United States • Uruguay • Venezuela

Rockwell Automation Headquarters, 1201 South Second Street, Milwaukee, WI 53204 USA, Tel: (1) 414 382-2000, Fax: (1) 414 382-4444

Rockwell Automation European Headquarters SA/NV, avenue Herrmann Debrouxlaan, 46, 1160 Brussels, Belgium, Tel: (32) 2 663 06 00, Fax: (32) 2 663 06 40

Rockwell Automation Asia Pacific Headquarters, 27/F Citicorp Centre, 18 Whitfield Road, Causeway Bay, Hong Kong, Tel: (852) 2887 4788, Fax: (852) 2508 1846