



Artisan Technology Group is your source for quality new and certified-used/pre-owned equipment

- FAST SHIPPING AND DELIVERY
- TENS OF THOUSANDS OF IN-STOCK ITEMS
- EQUIPMENT DEMOS
- HUNDREDS OF MANUFACTURERS SUPPORTED
- LEASING/MONTHLY RENTALS
- ITAR CERTIFIED SECURE ASSET SOLUTIONS

SERVICE CENTER REPAIRS

Experienced engineers and technicians on staff at our full-service, in-house repair center

*InstraView*SM REMOTE INSPECTION

Remotely inspect equipment before purchasing with our interactive website at www.instraview.com ↗

WE BUY USED EQUIPMENT

Sell your excess, underutilized, and idle used equipment. We also offer credit for buy-backs and trade-ins. www.artisanng.com/WeBuyEquipment ↗

LOOKING FOR MORE INFORMATION?

Visit us on the web at www.artisanng.com ↗ for more information on price quotations, drivers, technical specifications, manuals, and documentation

Contact us: (888) 88-SOURCE | sales@artisanng.com | www.artisanng.com

mini-OTDR AQ7250

Revolution for the installation and servicing of optical network



mini-OTDR AQ7250

Today's users demand the accurate transmission of extremely high-quality signals, so it is essential to use superior optical fibers. It is also vital to conduct accurate loss measurements when laying and maintaining optical fiber cables, and when checking for faults.

In addition to being capable of measuring loss and detecting faults in optical fibers, OTDRs must be compact and lightweight for easy handling in the field, and able to complete measurements quickly.

The mini-OTDR AQ7250 and optical unit meet all these requirements for building and maintaining optical fiber systems, as well as manufacturing and inspecting optical fiber material.

Compact, lightweight, and battery-powered, the AQ7250 offers a range of functions and capabilities

ideal for field use. Its exceptionally wide dynamic range is particularly effective for measuring lines over long distances, as well as lines with heavy loss. In addition, an improved measurement algorithm drastically reduces measurement processing time.

A wide range of optional equipment enables a single unit to be used for measurements on a variety of optical fiber lines. An optional high-speed printer or optical switch unit, as well as a visible light source or optical power meter can be installed on the main unit of the AQ7250. This eliminates the need to carry several measuring instruments on a single field mission.

This mini-OTDR, like its predecessors, has a large, viewer-friendly color screen and a 3.5-inch floppy disk drive as standard equipment.

Features

Wide dynamic range and short dead zone

The AQ7255B Single-mode Fiber Optical Unit (wavelength: 1.31/1.55 μ m) provides a dynamic range of 45/43 dB (typ.), enabling measurement of cables over extra-long distances, a function not available on previous models. In addition, the instrument's short dead zone can detect reflection as close as three meters away and loss measurement at eight meters.

High-speed, single-button measurement

Automatic measurement with single-button operation in just over 10 seconds (B-type unit).

Fast response

The screen updates a minimum of two times per second in preview mode, and allows real time checking of changes in the state of optical fibers in less than a second (twice as fast as previously).

Measurement of lines with large reflection

Reflections too large to be measured became measurable (using average rate of divided high reflection). The Single-mode Fiber Unit can measure return loss of near-end up to approximately 18dB.

Compact and lightweight

The compact B5 file-size AQ7250 weighs only 3 kg (approx.).

Large color LCD

The large 7.2-inch color LCD allows easy viewing of measurement values and waveforms. Background color of the display can be selected.

Long battery life

On batteries, the instrument has an operational life of approximately eight hours under normal service conditions, allowing a full day's work on one charge. Recharge time is approximately four hours.

Corresponds to various fibers and wavelengths

- Three-wavelength unit corresponds to 1.625 μ m
This unit can measure 1.625 μ m WDM line, as well as 1.31/1.55 μ m.
- Multi-mode unit corresponds to 0.85/1.30 μ m

Overview display function

The overview display function visually indicates which portion of a data waveform under measurement is being displayed. This function is useful for observing enlarged waveforms.

Stabilized light-source mode

In stabilized light-source mode, the instrument can also be used as a light source.

Stores huge volumes of measurement waveforms

The use of a PCMCIA hard disk card (option) and IC memory card (option) makes up for any shortfall in the storage capacity of the floppy disk for measurement waveforms.

Simplifies data processing

Use of the optional AQ7931B OTDR measurement data tabulation software allows you to reproduce waveform data recorded by the OTDR on a PC screen for analysis. In combination with the report preparation function (another built-in feature), this software makes it easy to prepare reports. The measurement data can also be output in a format compatible with commercial tabulation software.

Also supports a keyboard and mouse

The main unit can be operated using an optional mouse.

Supports a range of optical connectors

Various optical connector adapters can be used to enable quick and easy swapping of optical connectors.

Comprehensive array of functions

Automatic measurement

The instrument can automatically set up a distance range and display a list of splice losses and other data.

Automatic detection

Automatic detection of splice losses, return losses, and other measurement items exceeding preset thresholds is possible. When calculations are complete, the list screen is displayed, enabling you to view distances to splice points, splice losses, total losses, return losses, and other items at a glance. While checking the list display of automatically detected data, you can also add or delete splice points or change the detection threshold and recalculate data.

Continuous measurement

The continuous measurement function measures optical fibers efficiently. Specified measurement conditions are

read from a file, the system is set up accordingly, and the waveform is printed out or stored after measurement. All these operations are performed automatically. In addition, you can automatically switch channels and measure optical fibers by connecting the optional optical switch unit to the instrument.

Refractive index can be set for each section

The optical fiber analyzer requires refractive index settings in order to calculate fiber distances. The refractive index is specific to each fiber, but until now a single typical value had to be used for all fibers when multiple fiber types were being measured simultaneously. The AQ7250 allows you to set separate refractive indexes for each section, resulting in even more accurate distance measurements.

Measurement flow chart

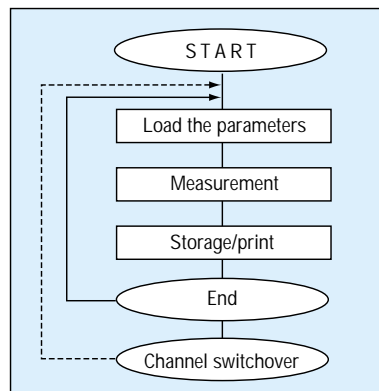

→ Ordinary continuous measurement
 - - -> Continuous measurement performed using the Optical Switch Unit

Sub Units

Mounted on the main unit.

Sensor Unit

Total loss measurement
 The AQ2761 Sensor Unit allows you to check total loss by receiving light from the stabilized light source of the optical unit.

VLS Unit

Fault detection in the near-end portion
 The AQ4253 VLS Unit enables you to detect a near-end fault or compare conductors.

GP-IB Unit

GP-IB control
 The GP-IB Unit enables you to implement GP-IB control, using an interface that was not available with previous mini-OTDRs.

Centronics Unit

Parallel interface conformed to Centronics.
 Can be connected to printer conformed to Centronics. (PCL, ESC/P, LIPS)



Extension Units

Mounted on the back of the main unit.

Printer Unit

High-speed printing
 The high-speed thermal printer can be mounted on the main unit. This allows a waveform image to be printed out within 10 seconds.

Optical Switch Unit

Multi-core fiber cable measurement capabilities
 The Optical Switch Unit for the AQ7250 enables efficient measurement of multi-core fiber cables.

Measurement examples

Long distance fiber

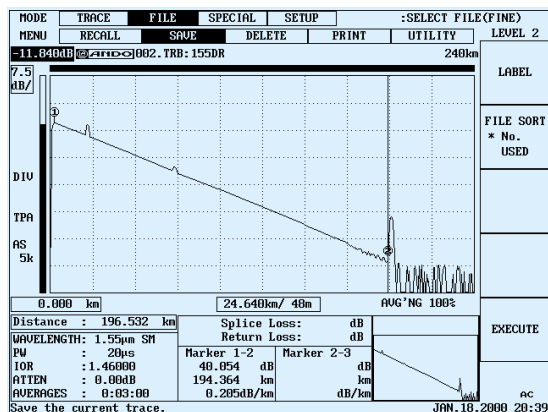

Combined with the AQ7255B single mode fiber optical unit, long distance fibers up to approximately 200km can be measured.

Return loss measurement

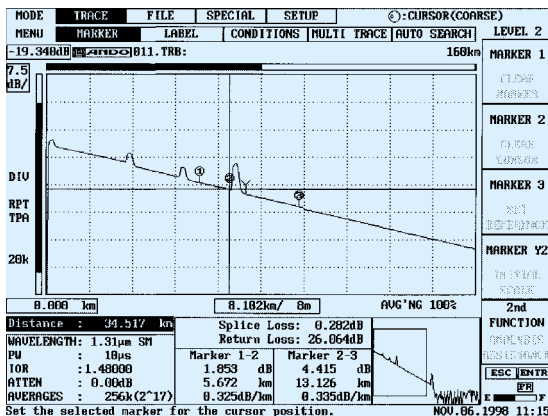

Measures the total return loss between two marker-selected points. Return loss is calculated from the difference between the backscatter level and the reflection level.

Auto-search function event display

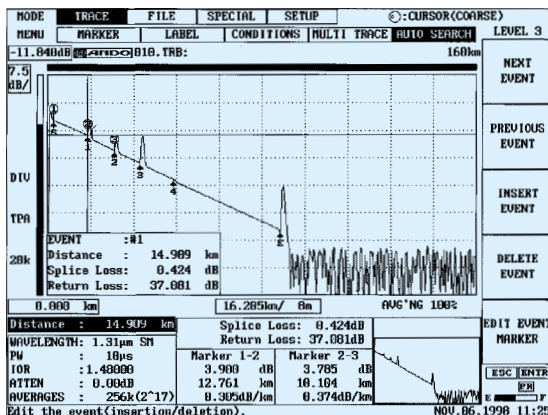

Automatic detection of splice or return loss values exceeding preset thresholds. It is also possible to edit the data generated, deleting unnecessary splice points or adding points that were not detected.

4-waveform display

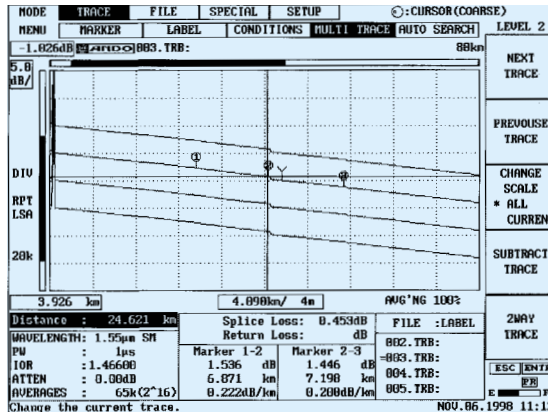

Up to four waveforms can be displayed on a screen, simplifying waveform comparison. Differential display is also possible — convenient for monitoring change over time.

Light power measurement

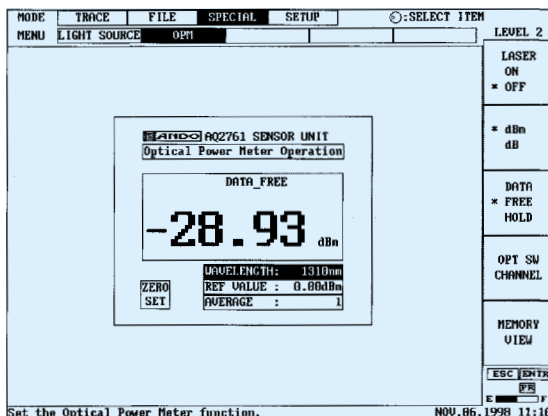

When used with the AQ2761 sensor unit option, the AQ7255 functions as an optical power meter.

Automatic search function event table

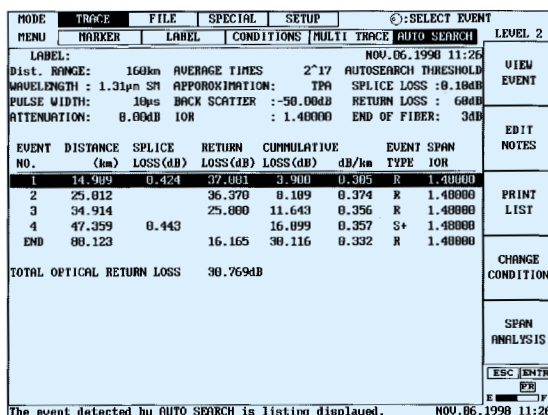

Displays distance to event, splice loss, and return loss, as well as the total return loss of a section, for each of the automatically detected waveforms. This is possible because the instrument captures all reflected light (returned light), including that from optical connectors, the far end, and backscattering light. It then calculates how much these various types of light have been attenuated with respect to the emitted light, to provide the total return loss for the optical fiber under measurement.

Description of screen

Screen description

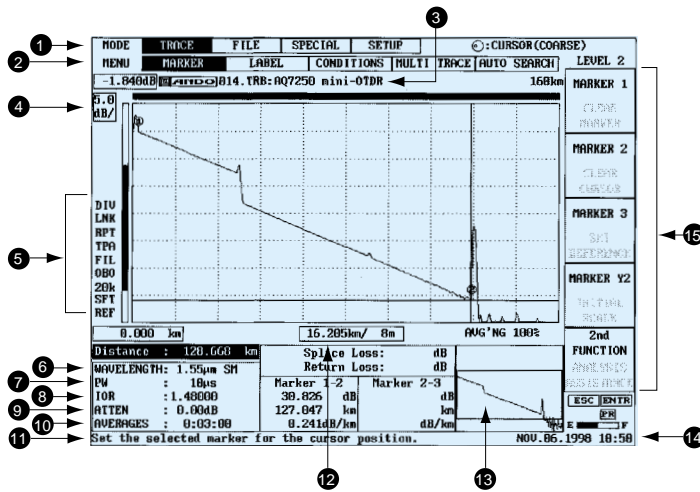

Enlarged/reduced and splice loss measurement display

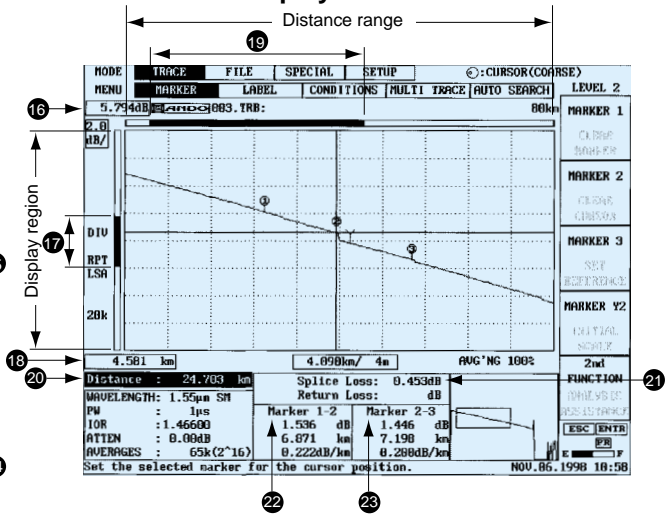

Screen description

- 1 Mode
Select TRACE, FILE, SPECIAL, and SETUP function screens.
- 2 Menu
Items change depending on the selected mode.
- 3 Label
Input of up to 36 alphanumeric characters.
- 4 Vertical-axis scale (dB/)
- 5 Currently active settings
LNK: Cursor link.
Used for simple splice loss measurement.
RPT: Repeat measurement function.
TPA, LSA: Approximation methods.
Two-point (TPA), least square (LSA).
FIL: Filter function.
OBO, AUT, ATT: Automatic measurement functions.
One-button measurement (OBO), auto-distance range (AUT), auto-attenuation (ATT).
20k, 5k: Sample data count.
Number of data points per waveform.
SFT: Slope fit.
Used for more accurate loss measurement.
REF: Distance origin.
- 6 Wavelength
Displays the measurement wavelength
- 7 Pulse width
- 8 Group refractive index
- 9 Attenuation
- 10 Averaging count or time
Averaging (2^{12} to 2^{20} counts), or averaged time.
- 11 Help screen
Provides brief explanations of operation.

- 12 Horizontal-axis scale (m/, km/)
- 13 Overview display screen
Full screen display of measurement waveform.
The selected portion of the main waveform display is shown in a window.
- 14 Date and time
- 15 Function keys
Displays key functions.
- 16 Vertical-axis display start level
Displays the level value for the top of the waveform display window.
- 17 Vertical-axis waveform display region
Indicates the display waveform range for the vertical full scale with a bar.
- 18 Horizontal-axis display start distance
Displays the distance value for the left side of the waveform display window.
- 19 Horizontal-axis waveform display region
Indicates the display waveform range for the horizontal full scale with a bar.

Splice loss measurement display

- 20 Cursor distance
Distance from the origin (optical output) to the cursor point.
- 21 Splice loss
- 22 Calculated values between markers ① and ②
Loss, distance, and loss per km between markers ① and ②.
- 23 Calculated values between markers ② and ③
Loss (except splice loss) between markers ② and ③, distance between markers ② and ③, loss per km between markers Y and ③.

Specifications

Main Frame

Display		7.2-inch color LCD (640 x 480 dots)
Horizontal axis	Full-scale	25m, 50m, 125m, 250m, 500m, 1km, 1.25km, 2km, 2.5km, 5km, 10km, 20km, 40km, 80km, 160km, 240km (Varies according to the unit)
	Shift	0 to distance range
	Resolution	Sampling resolution: 50 cm/min.
	Sample data count	20,000 points max.
	Distance accuracy	$\pm (5.0 \times 10^{-5} \times \text{measurement distance in meters} + 1\text{m})$
	Group refractive index setting	1.00000 to 1.99999, in 0.00001 steps
Vertical axis	Distance measurement	Displays the relative one-way distance between any two given points, in two ranges on the waveform, in eight digits.
	Scale	0.2 dB/div., 0.5 dB/div., 1 dB/div., 2 dB/div., 5 dB/div., and 7.5 dB/div.
	Shift	0 to 68 dB
	Read resolution	Max. 0.001 dB
	Loss measurement	Displays one-way losses in steps of 0.001 dB to a maximum of 5 digits. Displays the relative one-way loss, loss per unit length, and splice loss between any two given points in two ranges on the waveform.
Automatic measurement function		Provided
Return-loss measurement function		Return loss: calculated as the difference between the backscattered and reflected light levels. Total return loss: calculated as the attenuation of total reflected light in relation to total emitted light.
Memory	Floppy disk (3.5-inch, 2HD)	Can store up to 999 screens (screen mode) and measurement conditions.
	Others	Optional: PCMCIA hard disk card, IC memory card
Interface ¹⁾	Serial	9-pin D-sub
	Keyboard/mouse	6-pin DIN (Type PS/2)
	PCMCIA card slot	PCMCIA type II x 2 or type III x 1 for memory, or hard-disk cards
	Battery	Ni-MH (Duration: 7 hrs. typ.) ²⁾
Power requirements	AC adapter	AC100 to 240 V, 50/60 Hz
	External power supply	12 V +20%/-10% (for operation of unit only; not available for battery charging)
	Temperature	Operating temp. : 0 to +50° C (for floppy-disk drive 5 to 40° C/during charging 5 to 35° C) Storage temp. : -20 to +60° C
Environmental conditions	Relative humidity	85% RH or less (no condensation)
	Dimensions and mass	Approx. 290 (W) x 194 (H) x 75 (D) mm, approx. 3 kg with AQ7254B mounted
Accessories		Battery pack, AC adapter, shoulder belt, power cord, and instruction manual (one each)

● Notes

1) This unit should only be used with optional interface devices approved by Ando Electric.

Serial: For DPU printers that are PC/AT-compatible

Mouse: Connection cable required for mouse use. Microsoft mouse units are not supported.

2) Back light: Low, without mounting options. Battery life varies depending on operating conditions.

External design

Main Frame with Optical Unit

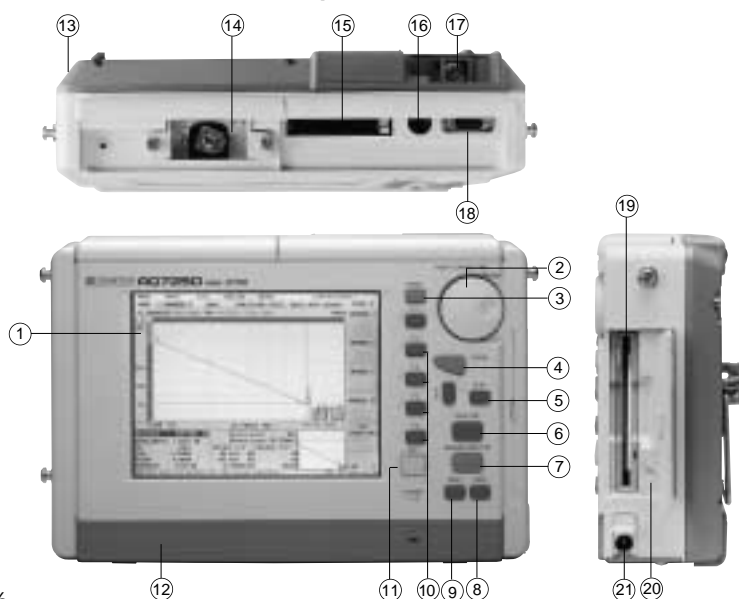

- ① Color LCD display
- ② Rotary knob
- ③ Mode key
- ④ Enter key
- ⑤ Up & Down, Right & Left key (for horizontal and vertical axes)
- ⑥ Real-time key (for preview)
- ⑦ Averaging Start/Stop key (for starting/stopping and averaging)
- ⑧ Save key (for storing waveform data)
- ⑨ Print key (for printing screen displays)
- ⑩ Function keys
- ⑪ Escape (ESC) key (for canceling items)
- ⑫ Battery pack
- ⑬ Optical unit
- ⑭ Sub unit port
- ⑮ PCMCIA slot
- ⑯ Mouse/Keyboard connector
- ⑰ Optical connector
- ⑱ Serial connector
- ⑲ Floppy disk drive
- ⑳ Power switch
- ㉑ Power connector

Optical Unit

Model	AQ7254B	AQ7255B	AQ7256B	AQ7259
Unit	Single-mode Fiber Unit			Multi-mode Fiber Unit
Measurement wavelength (μm)	1.31/1.55±0.03	1.31/1.55±0.025	1.31/1.55/1.625±0.025	0.85/1.30±0.03
Measured fiber	SM (10/125 μm)			GI (50/125 μm)
Distance range (km)	2, 5, 10, 20, 40, 80, 160, 240 ¹⁾			2, 5, 10, 20, 40, 80 ²⁾
Pulse width (sec) ³⁾	10 n, 20 n, 100 n, 200 n, 500 n, 1 μ, 4 μ, 10 μ, 20 μ			10 n, 20 n, 100 n, 200 n, 500 n, 1 μ
Dynamic range (dB) (SNR=1) ⁴⁾	40/38 (41.5/39.5) *	43/41 (45/43) *	41.5/39.5/37	22.5/24 ⁶⁾
Dead zone (m) ⁷⁾	Event	3	3	3 *
	Attenuation	10/12 (8/9) *	8/9	7/10 ⁶⁾ *
Stabilized light source	Wavelength (μm)	1.31/1.55	1.31/1.55	1.31/1.55/1.625
	Max. output (dBm)	-3±2	-3±2	-3±2
	Stability (dB)	±0.1	±0.1	±0.1/±0.1/±0.15
Optical connector ⁵⁾	AQ9441 (*) Universal Adapter: option			
Laser product class	Class 1 (FDA) and class 3A (IEC)			

● Notes

- 1) The 240 km range can be set for a wavelength of 1.55/1.625 μm.
- 2) The 40/80 km range can be set for a wavelength of 1.30 μm.
- 3) **AQ7254B, AQ7255B, AQ7256B:** A pulse width of 1 μs can be set for ≥ 10 km; a width of 4 μs or 10 μs is used for ≥ 40 km, and a width of 20 μs is used for ≥ 80 km.
AQ7259: Wavelength of 0.85 μm: the pulse width can be set from 10 to 200 ns. Wavelength of 1.30 μm: a pulse width of 1 μs can be set for ≥ 10 km.
- 4) The loss from the connection end of the measured fiber to the point at which the backscattered light level equals the noise RMS level is expressed as dynamic range (SNR=1).^(a)
- 5) *: Connector type. Specify FC, SC, ST or DIN connector.
- 6) With GI 62.5/125 μm

7) Dead zone

Event: At a point with a return loss ≥ 40 dB, reflection width at 1.5 dB from peak value^(b)

Attenuation: At a point with a return loss for the optical connector ≥ 40 dB, where the backscattered light level remains within a steady-state value ± 0.5 dB^(c)

AQ7254B, AQ7255B, AQ7256B: Event: At a pulse width of 10 ns
Attenuation: At a pulse width of 10 ns

AQ7259: Event: At a pulse width of 10 ns
Attenuation: At a pulse width of 10 ns/20 ns.

*: typical value

At Ta = 23 °C

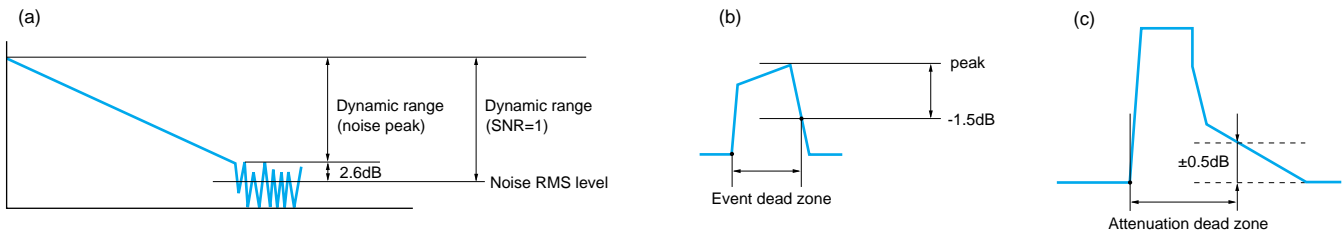

● Plus Print Unit (optional)



● Plus Optical Switch Unit (optional)

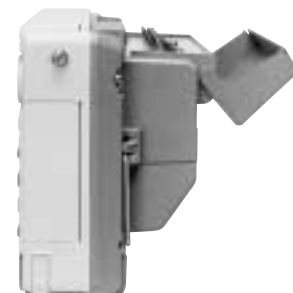

Sub Units

(Any one of these sub units can be mounted on the top of the main unit)

- **AQ4253(*) VLS Unit**
Visible LD light-source unit capable of detecting even near-end faults.
Wavelength: 635 ± 10 nm
Optical output level: -6 ± 1.5 dBm
Applicable optical fiber: SM (10/125 μ m)
Connector: FC or SC (factory option)
- **AQ2761 Sensor Unit**
Wavelength range: 850, 1310, 1550, 1625nm
Absolute accuracy: $\pm 5\%$ (at $\lambda = 1310$ nm)
Application: Light emitted from small-diameter silica fibers (Core dia. ≤ 162.5 μ m, NA ≤ 0.29)
Power measurement range: -60 to +10 dBm
Input: AQ9431(*) Connector Adapter (option)
(* Specify FC, SC or ST connector)

- **GP-IB Unit for AQ7250**
- **Centronics Unit for AQ7250**

Optional Accessories

- Spare battery pack
- AC adapter
- Mouse
- Hard-disk card
- Keyboard
- IC memory card

Cases

- **Soft carrying case**
Holds: Main unit, AC adapter, spare battery pack, printer unit or optical switch unit, printer paper, power cord, and instruction manual (one each).
- **Hard carrying case**
Holds: Main unit, AC adapter, spare battery pack, printer unit, optical switch unit, VLS unit or sensor unit, power cord, instruction manual (one each), and printer paper (2 pcs.).

AQ7931B OTDR Emulation Software

Measurement data can be transferred from a diskette to a PC for subsequent waveform analysis by the user. In addition, the AQ7931B's report function makes producing reports quick and easy.

(Also compatible with Windows95 and Windows98)
Windows95 and Windows98 are registered trademarks of Microsoft Corporation

Extension Units

(Any one of these extension units can be mounted on the back of the main unit)

- **Optical Switch Unit for AQ7250 ([] ch)**
Number of channels: 4, 8, 12, 16
Wavelength range: 1270 nm to 1670 nm
Insertion loss: 1.5 dB (typical value)
Return loss: 40 dB
Applicable optical fiber: SM (10/125 μ m)
Optical input/output connector: AQ9441(*)
Universal Adapter (option) (*Specify FC, SC, ST or DIN connector)
One extra connector adapter above the number of channels is required.
Dimensions: Approx. 250 (W) x 150 (H) x 70 (D) mm
- **Printer Unit for AQ7250**
Dimensions: Approx. 250 (W) x 150 (H) x 70 (D) mm

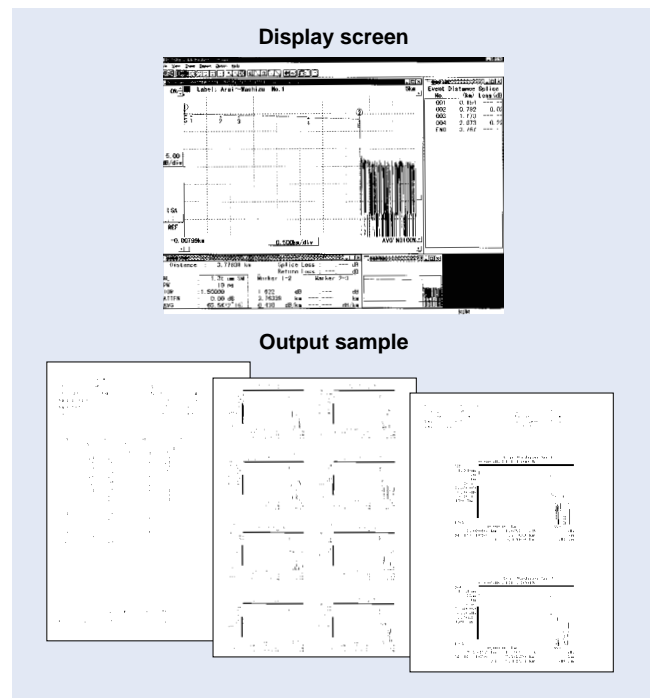

NOTE:
● "PCMCIA" refers to PCMCIA 2.1/JEIDA Ver4.2 or higher.
● All corporate, trade, and product names are the property of their respective companies.

Specifications are subject to change without notice.

Ando Electric Co., Ltd.

3-484, Tsukagoshi, Saiwai-ku, Kawasaki, Kanagawa, 212-8519 Japan Phone: +81 (0)44 549 7300 Fax: +81 (0)44 549 7450

Ando Corporation

20420 Century Boulevard Germantown, MD 20874, U.S.A. Phone: +1 301 916 0409 Fax: +1 301 916 1498
SAN JOSE OFFICE: 2021 N. Capitol Avenue, San Jose, CA 95132, U.S.A. Phone: +1 408 941 0100 Fax: +1 408 941 0103

Ando Europe B.V.

"Vijverdam", Dalsteindreef 57, 1112XC Diemen, The Netherlands Phone: +31(0)20 698 1441 Fax: +31(0)20 699 8938
NIEDERLASSUNG DEUTSCHLAND: Nymphenburger Straße 119 B, D-80636 München, Germany Phone: +49(0)89 143 8150 Fax: +49(0)89 143 81555

Ando Electric Singapore Pte. Ltd.

19 Kim Keat Road #05-03, Fu Tsu Building, Singapore 328804 Phone: +65 251 1391 Fax: +65 251 1987

Please visit our website for more information: www.ando.com



Artisan Technology Group is your source for quality new and certified-used/pre-owned equipment

- FAST SHIPPING AND DELIVERY
- TENS OF THOUSANDS OF IN-STOCK ITEMS
- EQUIPMENT DEMOS
- HUNDREDS OF MANUFACTURERS SUPPORTED
- LEASING/MONTHLY RENTALS
- ITAR CERTIFIED SECURE ASSET SOLUTIONS

SERVICE CENTER REPAIRS

Experienced engineers and technicians on staff at our full-service, in-house repair center

*InstraView*SM REMOTE INSPECTION

Remotely inspect equipment before purchasing with our interactive website at www.instraview.com ↗

WE BUY USED EQUIPMENT

Sell your excess, underutilized, and idle used equipment. We also offer credit for buy-backs and trade-ins. www.artisanng.com/WeBuyEquipment ↗

LOOKING FOR MORE INFORMATION?

Visit us on the web at www.artisanng.com ↗ for more information on price quotations, drivers, technical specifications, manuals, and documentation

Contact us: (888) 88-SOURCE | sales@artisanng.com | www.artisanng.com