



## Artisan Technology Group is your source for quality new and certified-used/pre-owned equipment

- FAST SHIPPING AND DELIVERY
- TENS OF THOUSANDS OF IN-STOCK ITEMS
- EQUIPMENT DEMOS
- HUNDREDS OF MANUFACTURERS SUPPORTED
- LEASING/MONTHLY RENTALS
- ITAR CERTIFIED SECURE ASSET SOLUTIONS

### SERVICE CENTER REPAIRS

Experienced engineers and technicians on staff at our full-service, in-house repair center

### *InstraView*<sup>SM</sup> REMOTE INSPECTION

Remotely inspect equipment before purchasing with our interactive website at [www.instraview.com](http://www.instraview.com) ↗

### WE BUY USED EQUIPMENT

Sell your excess, underutilized, and idle used equipment. We also offer credit for buy-backs and trade-ins. [www.artisanng.com/WeBuyEquipment](http://www.artisanng.com/WeBuyEquipment) ↗

### LOOKING FOR MORE INFORMATION?

Visit us on the web at [www.artisanng.com](http://www.artisanng.com) ↗ for more information on price quotations, drivers, technical specifications, manuals, and documentation

**Contact us:** (888) 88-SOURCE | [sales@artisanng.com](mailto:sales@artisanng.com) | [www.artisanng.com](http://www.artisanng.com)

# MP1630B

## Digital Data Analyzer

10 kHz to 200 MHz



*16-Channel PPG and ED in One Cabinet  
Eye Diagram Measurement Based on BER*

## Seamless Testing of Digital Equipment in Communications, Computing and Broadcasting Fields

The MP1630B is general-purpose bit error measuring instrument that can simultaneously measure multi-channel signals and burst signals at up to 200 MHz. The analyzer runs under the Microsoft® Windows® operating system version 3.1 and has a bright 10.4" TFT color LCD with touch screen and 1 GB HDD for easy-to-use operation.

The MP1630B is not only for continuous signals — it can measure burst-signal bit error rates as well. Consequently, it is easily able to handle burst signals used by TDMA (Time Domain Multiplex Access) methods and packet/cell transmissions, etc. Both a Pulse Pattern Generator Unit and Error Detector Unit can be installed in the MP1630B, to measure simultaneously parallel data for 16 channels using just one unit. In addition, the eye margin measurement function can be used to measure the threshold margin and the phase margin at a specific error rate. This data can be displayed graphically in an eye margin diagram. This function cannot be measured with an oscilloscope. The eye margin measurement is very useful for analysis of all the margins of the data signal.

The MP1630B is for a wide range of applications from R&D to manufacturing next-generation multimedia devices and digital equipment.

### Main Functions

#### Built-in 16-Channel Pulse Pattern Generator and Error Detector Units

- 16-Channel Data, Clock and Trigger I/O
- 8-Channel AUX Output (Reset/Envelope Signal)

#### Continuous/Burst Signal Bit Error Measurement

- Variable Burst Cycle, Guard Time (Bit Units)
- Variable Bit Length for Preamble, Overhead, and Information Bit for Each Channel

#### Full Lineup of Patterns for Each Transmission Method

- PRBS ( $2^n - 1$ ,  $n = 7$  to 31, variable mark ratio)
- PRGM (Programmable 64 kb/ch)
- Zero Substitution Pattern
- Mixed Pattern (Any PRGM and PRBS selectable)
- PON Pattern (for Testing Passive Optical Network Modules)

#### High-Performance Synthesizer

- 1 to 200 MHz (1 kHz Steps), 10 kHz to 1 MHz (100 Hz Steps),  $\pm 2$  ppm Accuracy
- Optional Built-in Jitter Modulation Function

#### Auto Search Function

- PRBS Identification
- Clock Phase and Data Threshold

#### Error Analysis Functions

- Error Performance Measurement (ITU-T Rec. G.821)
- Eye Margin Measurement
- Delay Measurement

#### Excellent Operability

- Large, Clear Color LCD with Touch Screen
- Windows 3.1 OS

### Applications

- Testing Multi-channel Modules for Optical Interconnection
- E/O, O/E Evaluation for Optical Networks (PON/PDS)
- Testing SDH/ATM Equipment and Modules
- Testing Cable Modems for Digital CATV
- R&D on TDMA
- R&D on Wireless LAN Peripherals
- Evaluating Next-Generation PC Interfaces (Fiber Channel, IEEE 1394, SSA, ATM-25)
- Evaluating Digital Demodulators including QPSK/QAM, etc.
- Evaluating IrDA Communications Equipment
- Evaluating Communications LSIs, ASICs/FPGAs and CCDs, etc

## Essential Tool for Multimedia Era

### Simultaneous Bit Error Measurement of 16 Channels

The MP1630B has 16-channel Pulse Pattern Generator and Error Detector Units, and can measure bit errors in parallel and simultaneously. Conventional measurement method was not economical for continuous evaluation of the performance of each route of devices with N:N input/output ports by switching inputs and outputs using a selector. Using the MP1630B shortens the time required to measure each device to 1/N, thereby greatly improving production efficiency.

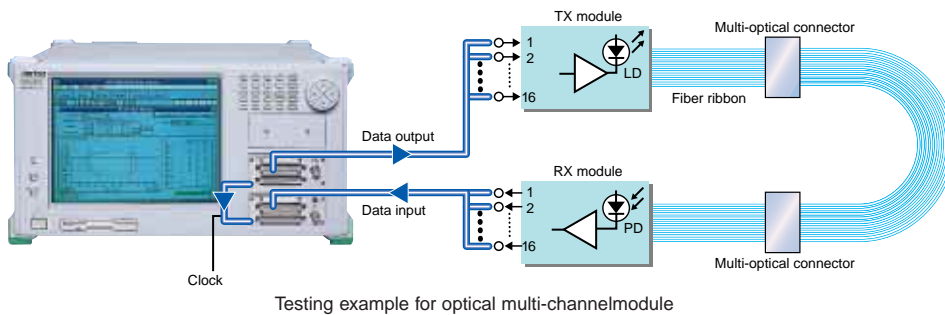

### For Both Continuous and Burst Data

For example, continuous data is used in the PDH/SDH transmission system, burst data is used in the PON (Passive Optical Network) subscriber TDMA transmission system, as well as in the burst cell unit ATM-PON transmission system. The MP1630B can handle bit error measurement of both continuous and burst data. It can output burst data for up to 16 channels. And the burst cycle, guard time, preamble length and data length can all be varied. Moreover, the data section of each burst data can be split into a maximum of 7 blocks and any pattern type (PRGM or PRBS) and length can be set for each block. Furthermore, the error detector receives a serial data combined by star coupler, then specify the each burst area and measure the bit error rate for each channel simultaneously.

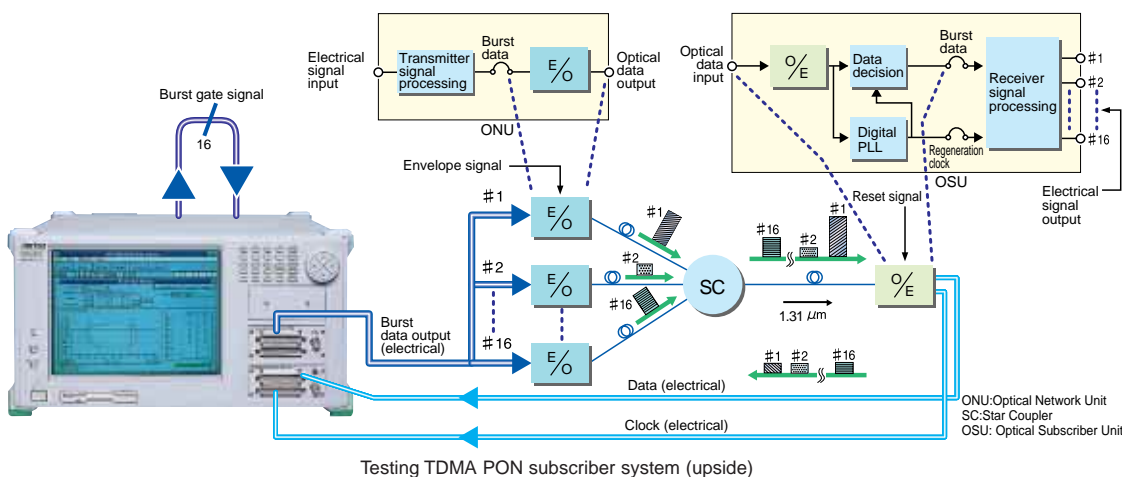
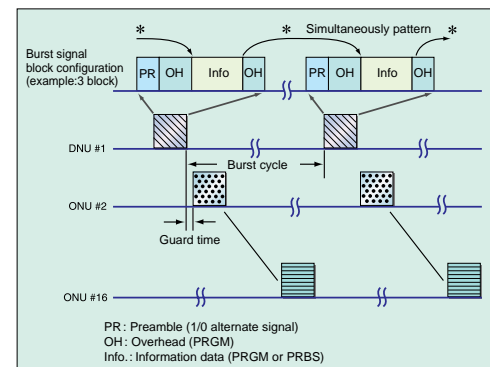

## ●Mixed Pattern Generation, Selective BER Measurement

With the MP1630B, a test pattern can be selected and set for each channel. Not only can both PRGM and PRBS patterns be used, but a mixed pattern composed of both PRGM and PRBS patterns can be generated too. The packet type and cell type data can be configured smoothly from the overhead and payload parts.

Moreover, the pattern field can split into 2 to 32 blocks and a PRGM or PRBS pattern can be allocated to each column individually. As a result, it is possible to create pseudo-test signals for SDH/ATM, etc., as well as signals for evaluating complex communication protocols.

On the other hand, just the required blocks can be measured by masking the specified blocks, even at the Error Detector side. Measurement is even possible by selecting and combining the overhead and information parts. This flexibility of the pattern generation and error detection functions makes the MP1630B a powerful general-purpose digital analyzer.

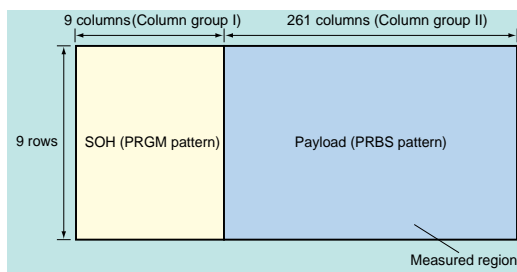

Example of pseudo SDH signal  
(2 column groups x 9 rows = 18 blocks)

MIX Pattern Detail Setup								
Total Length = 262,144bits								
Column1	Column2	Column3	Column4	Column5	Column6	Column7	Column8	Column9
Length1	Length2	Length3	Length4	Length5	Length6	Length7	Length8	Length9
8,192	8,192	8,192	8,192	8,192	8,192	8,192	8,192	8,192
PRGM	PRBS	PRGM	PRBS	PRGM	PRBS	PRGM	PRBS	PRBS
Row1	#1	#2	#3	#4	#5	#6	#7	#8
Row2	#9	#10	#11	#12	#13	#14	#15	#16
Row3	#17	#18	#19	#20	#21	#22	#23	#24
Row4	#25	#26	#27	#28	#29	#30	#31	#32

32 Block mixed pattern setting screen

## ●Superior Basic Functions

A high-performance frequency synthesizer is built into the MP1630B. It generates stable, accurate signals with high resolution in the 10 kHz to 200 MHz band. In addition,

when the optional digital modulator function is used, the jitter tolerance of communications equipment and devices can also be measured.

In addition to TTL, LVTTTL, ECL, and PECL, the pulse pattern generator clock and data output levels can be set to any output (0.25 to 2.5 V at 50 Ω termination; 0.5 to 5.0 V at high) for a variety of interfaces. The data and clock output delay can be varied at high resolution for each channel and there is no necessity to adjust the cable length for each signal. The clock input of the Error Detector can also be varied for each channel.

Furthermore, by using the Auto Search function, the phase relationship of the input data and clock can be adjusted automatically to the best position, eliminating the need for troublesome adjustments.

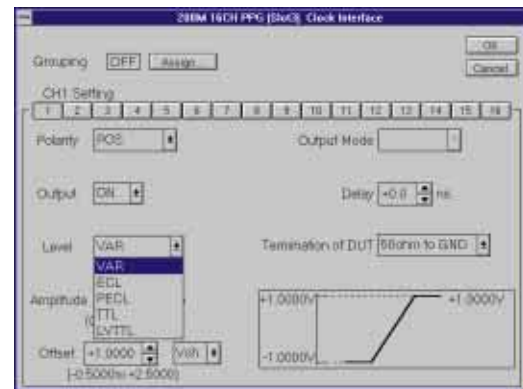

Pulse pattern generator clock interface screen

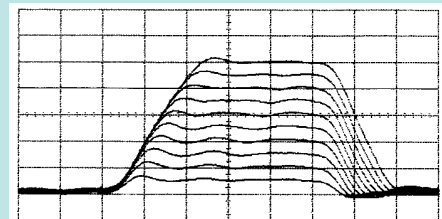

100 MHz (V: 500 mV/div, H: 1 ns/div)  
Amplitude: 0.25 to 2.5 Vp-p/0.25 V steps (averaged waveform)

Variable level (amplitude) characteristics

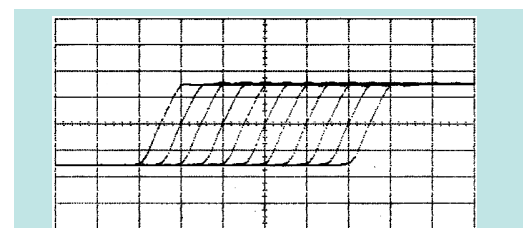

10 MHz (V: 800 mV/div, H: 2 ns/div)  
Clock delay: -5 to +5 ns/1 ns steps (averaged waveform)

Variable delay characteristics

## ●Evaluating Error Correction Function using Burst Error Insertion

In addition to having the earlier cyclic and single error-mode insertion functions, the MP1630B also has burst-mode insertion functions, making it ideal for evaluating the efficiency of error-correction codes used by each type of communication protocol. In particular, it is especially effective for testing digital transmission methods used by broadcast satellites and mobile phones, etc.

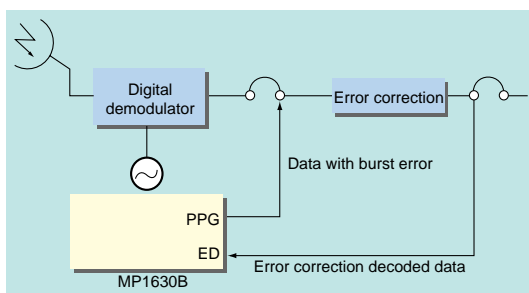
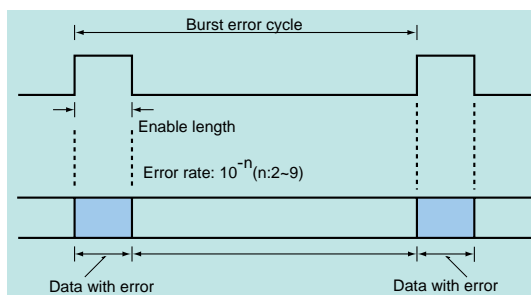

Evaluating error correction using burst error insertion function

## ●Evaluating Data Waveform Quality using Eye Margin Measurement

Sometimes there are bit errors even if the eye pattern on oscilloscope looks good. The MP1630B eye margin measurement function shows its usefulness in this circumstance; if necessary, it automatically measures the threshold voltage and phase range below the specified error rate. It has two measurement modes: the Margin mode, which measures the margin range as numeric values, and the Diagram mode, which plots the margin range as a graph on 2-dimensional axes (x: threshold margin, y: phase margin). These modes can be selected according to the application.

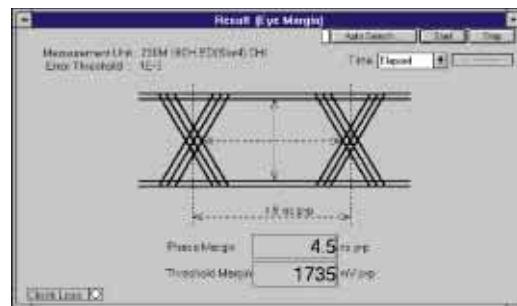

Margin mode

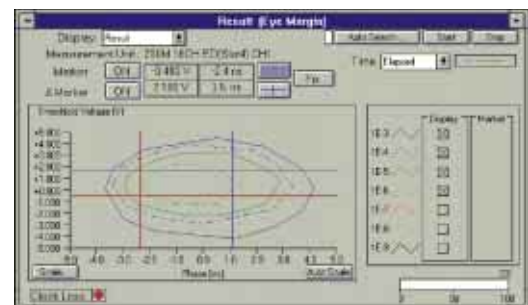

Diagram mode



## Large, Clear Color LCD with Touch Screen

### Which input method do you prefer?

- 1 Touch screen
- 2 Mouse (standard accessory)
- 3 Ten keys and rotary encoder
- 4 Keyboard (sold separately)

#### 1 Large Color LCD with Touch Screen

The analyzer uses the Windows 3.1 OS; the hierarchy of measurement parameter levels has been decreased for better usability.

#### 2 Data Input Keys

These keys are used to input numeric values, alphabetic characters and units. Alphabetic input uses pattern data editing in HEX code.

#### 3 Rotary Encoder Knob

The outer ring of the knob is used to input continuously-variable numeric values for the frequency and output level, etc. The inner part is used as the  $\wedge$ ,  $\vee$ ,  $<$ , and  $>$  functions, and as the cursor key for selecting measurement parameters.

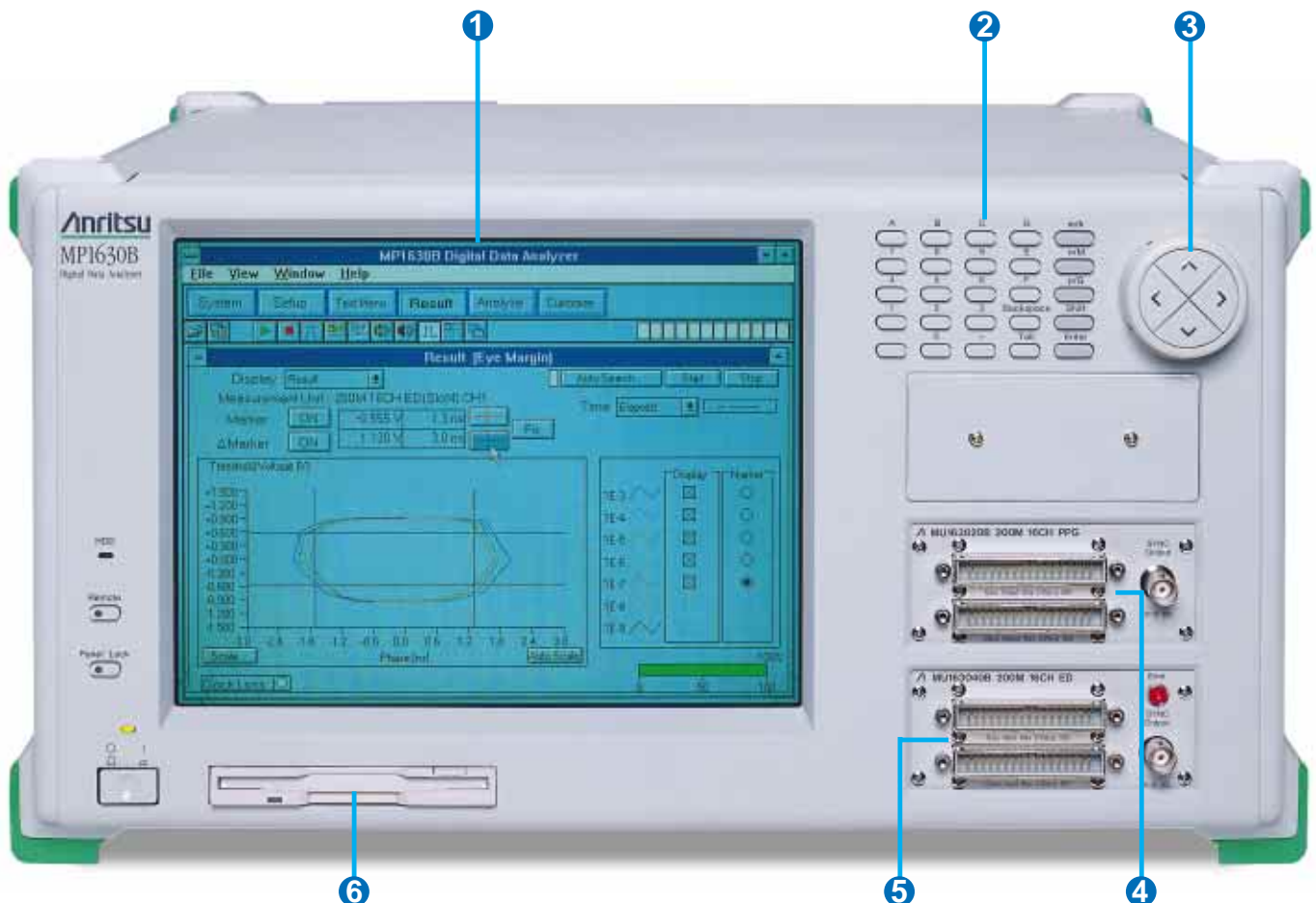

**4 Pulse Pattern Generator Unit (200 Mb/s, 16 channels)**

**5 Error Detector Unit (200 Mb/s, 16 channels)**

**6 3.5" FDD**

This is an MS-DOS format 1.44 MB/740 KB mode disk drive.

**7 Clock Generator Unit**

This unit can also accept input of an external clock. The option 01(jitter addition) is included in the below photograph.

**8 Pulse Pattern Generator Unit (200 Mb/s 16 channels)**

This unit has a burst trigger output (16 channels) and an AUX output (8 channels).

**9 Error Detector Unit (200 Mb/s, 16 channels)**

This unit has a burst trigger input (16 channels), etc.

**10 RS-232C (COM1)**

This port is used to connect an external controller.

**11 Keyboard Connector**

**12 Mouse Connector**

**13 CRT (VGA)**

This connector is used to connect an external monitor.

**14 GPIB (Option 01) or Ethernet (Option 02)**

This connector is used to connect an external controller.

**15 Printer**

This connector is used to connect an external printer.

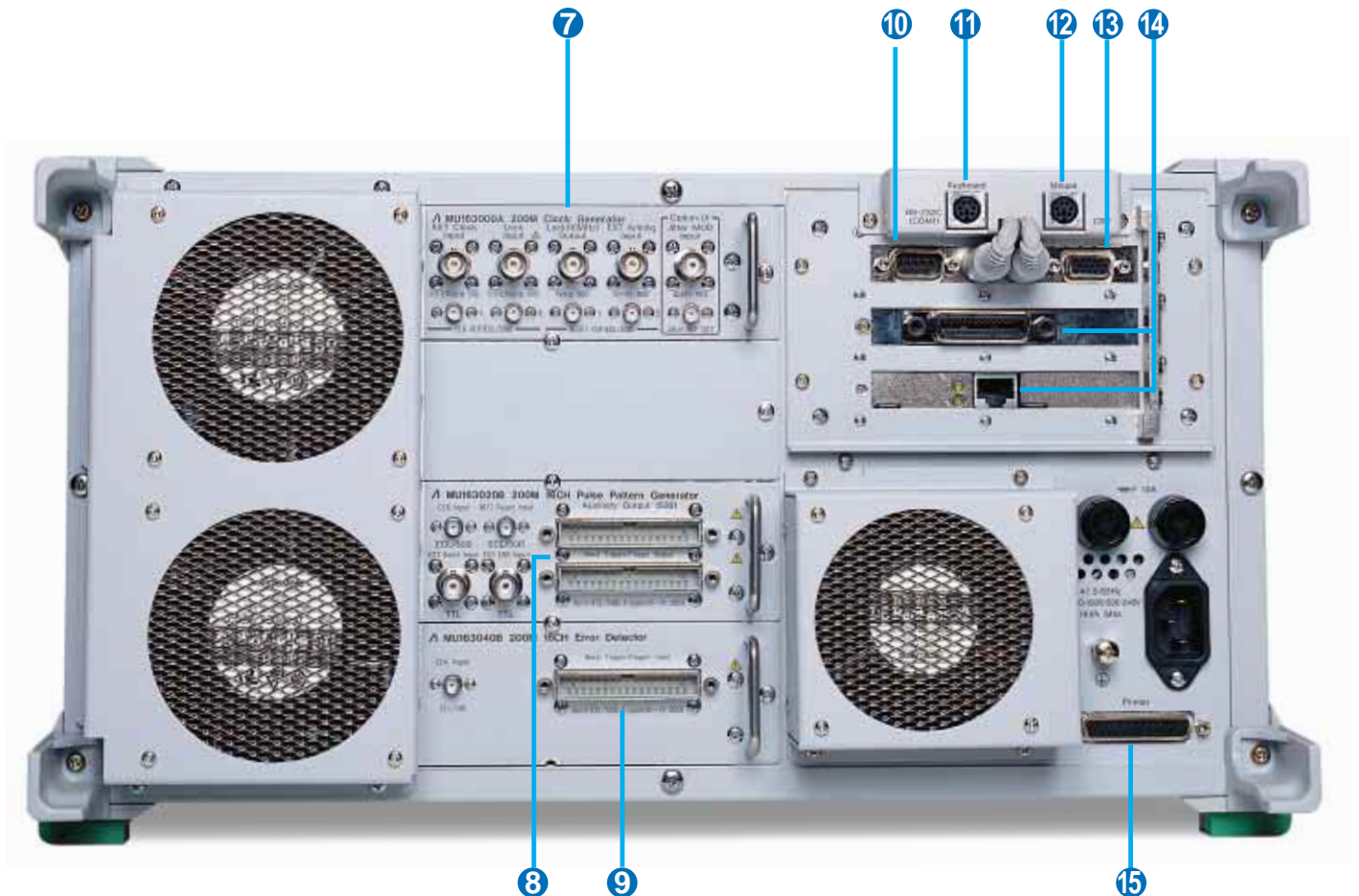



## Easy-to-Use GUI

### ●One-Key/One-Parameter Operation using Customized Screens

Measurement of general multi-channel data requires complex operations to manage the large numbers of measurement parameters. To make measurement settings simpler, the MP1630B has the convenient one one-key/one parameter operation used previously in the Anritsu BERTS, as well as customized screens. It also has a Grouping function which groups together the same measurement items used for each channel. Common settings (all or pattern-only) are saved as files on the large internal hard disk. The user can freely select the measurement parameters to create customized screens with the required measurement items and results. These file and customized screen functions (or Grouping function) for multi-channels are used in the same way as the earlier single-channel BERTS.

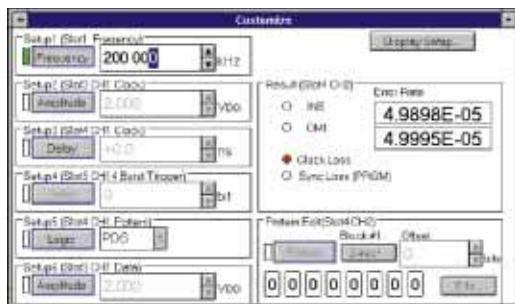

Customized screen

### ●Powerful Pattern Editor Function

The MP1630B pulse pattern generator and error detector PRGM patterns can be edited easily using the keyboard, mouse, or cursor keys. There are three editing modes matching the various applications: Time, State, and Dump. The Time mode puts time on the horizontal axis and displays the pattern for each channel as a horizontal line. The State mode displays the data of channel 1 as the MSB and parallel 16 bits (corrected 1 bit from each channel at a time) as one data item.

The Dump mode displays the pattern for the specified channel as a memory dump image using either binary or hexadecimal code.

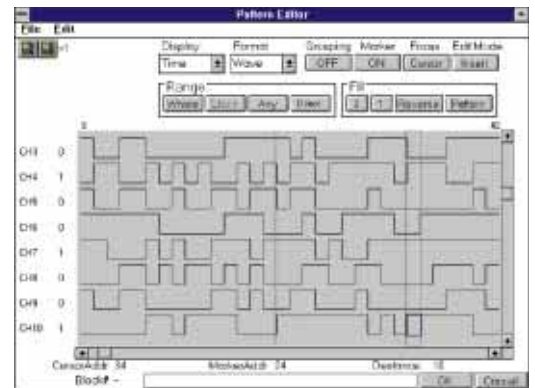

Pattern editor (time mode, input waveform)

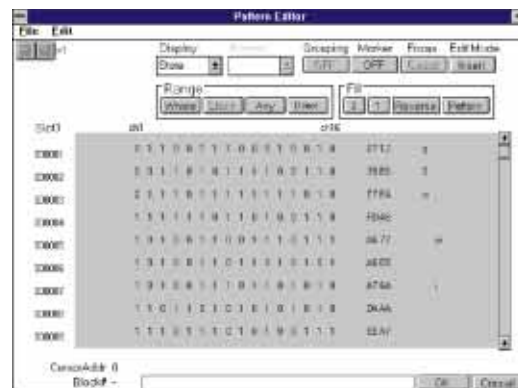

Pattern editor (state mode)

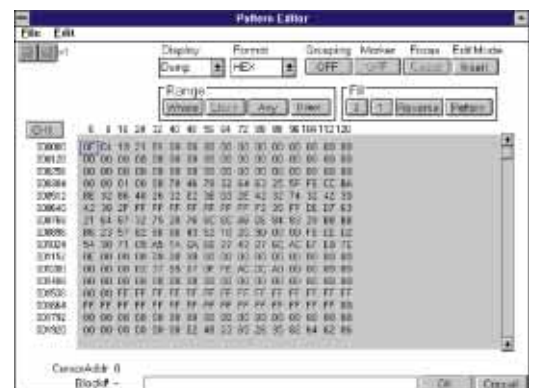

Pattern editor (dump mode)

### ●Easy-to-Use Interface

Useful setting and pattern data can be saved as a file to either 3.5" FD or the large-capacity internal hard disk. In addition, video-out and printer interfaces for displaying screens and measurement results are provided as standard. Moreover, the standard RS-232C I/F, optional GPIB I/F and Ethernet I/F (option) permit the analyzer to be either controlled by a host or to control other equipment, allowing configuration of advanced measurement systems.

## Specifications

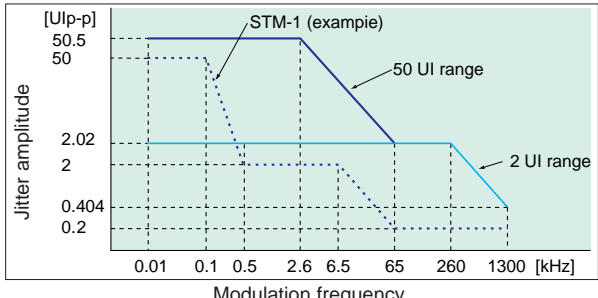
<p>Clock</p>	<p>Internal            Operating frequency: 10 kHz to 200 MHz (accuracy: <math>\pm 2</math> ppm)            Resolution: 1 kHz steps (&gt;1 to 200 MHz), 100 Hz steps (10 kHz to 1 MHz)</p> <p>External            Input frequency range: 10 kHz to 200 MHz            Input level: AC, 0.5 to 2.0 Vp-p (50 <math>\Omega</math>), BNC connector</p> <p>External (at locked)            Input frequency range: 10 MHz <math>\pm 100</math> ppm, 64 kHz <math>\pm 100</math> ppm            Input level: AC, 0.5 to 2.0 Vp-p (50 <math>\Omega</math>), BNC connector</p>
<p>Jitter modulation function (option)</p>	<p>External modulation input            Modulation frequency range: 10 Hz to 1.3 MHz            Input level range (sine wave): -1 to +1 V (75 <math>\Omega</math>), BNC connector            Reference output (jitter-free output): AC, 1 Vp-p (50 <math>\Omega</math>), SMA            Jitter: 0 to 50.5 UIp-p (clock frequency: &gt;100 to 200 MHz) *Switchable to 50 UI/2 UI range</p> 
<p>Test pattern (pulse pattern generator, error detector)</p>	<p>PRBS Pattern: <math>2^n - 1</math> (n: 7, 9, 11, 15, 20, 23, 31), variable mark ratio, logic selectable            Zero substitution pattern: <math>2^n</math> (n: 7, 9, 11, 15); pattern length: n to <math>2^n - 1</math>, logic selectable            PRGM pattern: 2 to 65,536 bits/channel bit length, logic selectable            Mixed pattern: Mixed PRGM and PRBS pattern, logic selectable                *Block numbers: 2 to 32 [PRGM bit length/block: 8 to 8,192 bits; PRBS bit length/block: 8 to 131,072 bits (depend on block numbers)]            PON pattern [TDMA test patterns with preamble inserted in ahead of Mixed patterns (PRGM and PRBS)]                Preamble (1010...): 0 to 64 bits; guard time: -2,097,083 to 2,097,067 bits (1 bit resolution)                Burst mode: Internal (burst cycle: 0.01 to 10 ms), external (enable length: 8 to 2,097,144 bits)</p> <p>Pattern edit function            Edit mode: Dump, timing diagram, state table            Edit results storage: Internal HDD, or FDD</p>
<p>Error insertion</p>	<p>Each channel, simultaneous or independently            Error type: Normal, burst            Normal mode (internal: cyclic or single, external)                Error rate: <math>10^{-n}</math> (n: 3 to 9)                Insert area: Entire area, selected blocks (in Mixed pattern or PON pattern)</p> <p>Burst mode (internal/external)                Error rate: <math>10^{-n}</math> (n: 2 to 9)                Internal enable length: 20 to 140 ms (resolution: 20 ms)                Internal cycle: 1 to 10 s (resolution: 1 s)                External mode: Error of specified rate inserted in external signal enable period</p>
<p>Data/clock output</p>	<p>Output No.: 16 (multipin connector), output on/off and logic selectable            Output waveform: NRZ (data), RZ (clock)            Output level: ECL, PECL, TTL, LVTTTL, VAR            VAR range                Amplitude: 0.5 to 5 V (10 mV steps, high impedance), 0.25 to 2.5 V (5 mV steps, 50 <math>\Omega</math>)                Offset: -4.5 to +5 V (5 mV steps, high impedance), -2.25 to +2.5 V (2.5 mV steps, 50 <math>\Omega</math>)                Rise/fall times (typ.): 1.3 ns (1 Vp-p, 50 <math>\Omega</math> termination)                Clock delay: -5 to +5 ns (100 ps steps)                Data skew: -5 to +5 ns (100 ps steps)</p>
<p>Data/clock input</p>	<p>Input No.: 16, logic selectable, multipin connector            Input waveform: NRZ (data), RZ (clock)            Input level: ECL, PECL, TTL, LVTTTL, VAR            VAR input range                Amplitude: 0.5 to 5 V (50 <math>\Omega</math>)                Threshold level: -5 to +5 V (5 mV steps, in 50 <math>\Omega</math> to GND termination)                Clock delay: -5 to +5 ns (100 ps steps)</p>
<p>Measurement data</p>	<p>Channel No.: 16 channels simultaneous measurement (selectable measurement channels)            Signal format: Continuous or burst (internal/external)</p>

Bit error measurement		<p>Error detection: All, insertion, omission  Measurement region: All, PRGM, PRBS selectable, and each block selectable with block configuration  Display  Error rate: <math>0 \times 10^{-16}</math> to <math>1.0000 \times 10^0</math>  Error count: 0 to 9999999, <math>1.0000 \times 10^7</math> to <math>9.9999 \times 10^{16}</math>  Error interval: 0 to 9999999, <math>1.0000 \times 10^7</math> to <math>9.9999 \times 10^{16}</math>  Error free interval: 0.0000 to 100.0000%  Error performance: ITU-T Rec. G.821  Measurement mode: Single, repeat, untimed (1 second to 99 days 23 hours 59 minutes 59 seconds)  Auto sync: ON/OFF switchable, [threshold value: <math>1 \times 10^{-n}</math> (n: 2 to 8)], with autosearch function</p>
Alarm measurement		Detected items: Power loss, clock loss, pattern sync loss (PRGM, PRBS)
Frequency measurement		<p>Measurement range: 10 kHz to 200 MHz  Effective digits: 6 digits  Resolution: 100 Hz  Accuracy: <math>\pm(1 \text{ count} \pm 10 \text{ ppm})</math></p>
Eye margin measurement (based on BER)		<p>Measures eye margin or eye diagram of specified data (1 channel)  Eye margin: Displays threshold margin and phase margin as numeric value  Eye diagram: Displays width of eye aperture as two-dimensional graph using bit-error measurement</p>
Delay measurement		<p>Mode: Single/repeat  Unit: Time/bit numbers  Range  Time: 0 to 999 <math>\mu</math>s (1 <math>\mu</math>s steps), 1 to 999 ms (1 ms steps), 1 to 10 s (1 s steps)  Bits: <math>2^{31}</math> bit (max.)  Time out: 0.5, 1, 2, 5, 10 s</p>
I/O signal for burst BER measurement	Pulse pattern generator	<p>External burst input  Level: TTL (H: Enable, L: Disable), BNC connector  Burst trigger output (index signal for each burst data)  Output No.: 16 (for each data output), bit delay function  Level: ECL, -2 V (50<math>\Omega</math>), multipin connector  Auxiliary output (PON system envelope, or AGC reset signal; usable as normal control signal)  Output No.: 8 (selectable channel), 1 (OR output for each channel), bit delay function, logic selectable  Level: ECL or TTL (<math>\leq 100</math> Mb/s), multipin connector</p>
	Error detector	<p>Burst trigger input  Input No.: 16 (for each data input)  Level: ECL, -2 V (50 <math>\Omega</math>), multipin connector</p>
Other I/O signals		<p>Sync signal output (pulse pattern generator, error detector)  Sync source: 1/1 clock, 1/8 clock, PRGM pattern, PRBS pattern  Level: 0/-1 V (50 <math>\Omega</math>), BNC connector  External error input (pulse pattern generator)  Error mode: Normal, burst  Level: TTL, BNC connector  Trigger output (pulse pattern generator)  Trigger source: Unique pattern index for delay measurement or pattern block index in MIX/PON pattern  Level: 0/-1 V (50 <math>\Omega</math>), multipin connector  Trigger input (error detector)  Trigger source: For delay measurement  Level: 0/-1 V (50 <math>\Omega</math>), multipin connector</p>
System environment		<p>Platform: Microsoft Windows operating system version 3.1  Display: Color LCD, touch screen, 640 <math>\times</math> 480 dots, 256 colors  Printer: Parallel port for printer, D-sub 25-pin connector  Keyboard: 101 keys (English), PS/2 mini-DIN 6-pin connector  Mouse: Serial, PS/2 mini-DIN 6-pin connector  FDD: 2 mode (1.44 MB, 740 KB)  HDD  C drive: <math>\geq 1,380</math> MB (for measurement data, patterns)  D drive: 30 MB (not released to user, interface: IDE)</p>
Remote control		RS-232C (standard), GPIB (option): IEEE488.2, Ethernet (option): 10 Base-T
Other functions		Sound: When error or alarm detected, panel lock function, self check function
Power		100 to 120/200 to 240 Vac, 47.5 to 63 Hz, $\leq 1,000$ VA
Dimensions and mass		426 (W) $\times$ 221.5 (H) $\times$ 451 (D) mm, $\leq 29$ kg
Operating temperature		5° to 40°C

The specifications are with the MU163000A (200M Clock Generator Unit), MU163020B (200M 16CH Pulse Pattern Generator Unit) and MU163040B (200M 16CH Error Detector Unit) installed in the MP1630B main frame.

## Ordering Information

Please specify model/order number, name and quantity when ordering

Model/Order No.	Name	Remarks
MP1630B	<p><b>Main frame</b> Digital Data Analyzer</p> <p><b>Standard accessories</b></p> <p>J0491 Power cord (shielded): 1 pc            F0087 Fuse, 10 A: 2 pcs            Z0319A PS/2 mouse: 1 pc            Z0320 Input pen: 1 pc            Z0388 MP1630B recovery disk: 11 pc            Z0389 MP1630B application disk: 7 pc            Z0390 MP1630B remote sample disk: 1 pc            Z0396A pen holder: 1 pc            W1442AE MP1630B operation manual: 1 copy            W1443AE MP1630B remote control operation manual: 1 copy            W1450AE MP1630B auto adjust operation manual: 1 copy</p> <p><b>Options</b></p> <p>MP1630B-01*1 GPIB            MP1630B-02*1 Ethernet</p> <p><b>Peripherals</b></p> <p>Z0321A Keyboard (PS/2)            J0008 GPIB cable            MB24B Portable Test Rack            B0348 Soft case            B0329D Front cover            B0333D Rack mount kit</p>	<p>Only for MP1630B customer            Only for MP1630B customer            Only for MP1630B customer</p> <p>GPIB interface board            Ethernet interface board</p> <p>Specified current: 10 A</p>
MU163000A*1	<p><b>Plug-in unit</b> 200M Clock Generator Unit</p> <p><b>Standard accessories</b> W1187AE MU163000A operation manual</p> <p><b>Option</b> MU163000A-01*1 Jitter addition</p> <p><b>Peripherals</b> J0776D Coaxial cord (BNC-P-3W · 3D-2W · BNC-P-3W), 2 m</p>	<p>Double shield</p>
MU163020B*1,*2	<p><b>Plug-in unit</b> 200M 16CH Pulse Pattern Generator Unit</p> <p><b>Standard accessories</b> J0693B SMA cable, 0.27 m: 2 pcs            W1444AE MU163020B/163040B operation manual: 1 copy</p> <p><b>Peripherals</b>            J0776D Coaxial cord (BNC-P-3W · 3D-2W · BNC-P-3W), 2 m            J0824 BNC multi-core cable, (16 pins), 1 m            J0825 BNC multi-core cable, (9 pins), 1 m            J0826 SMA multi-core cable, (16 pins), 1 m            J0827 SMA multi-core cable, (9 pins), 1 m            J0858 SMA multi-core cable, (16 pins), 2 m            J0859 SMA multi-core cable, (9 pins), 2 m            J0860 BNC multi-core cable, (16 pins), 2 m            J0861 BNC multi-core cable, (9 pins), 2 m</p>	<p>Double shield</p>

Model/Order No.	Name	Remarks
MU163040B*1,*2	<b>Plug-in unit</b> 200M 16CH Error Detector Unit	
	<b>Standard accessories</b>	
J0828	Multi-core cable, (16 pins), 0.5 m: 2 pcs	
J0829	Multi-core cable, (17 pins), 0.5 m: 1 pc	
J0693D	SMA cable, 0.27 m: 1 pc	
W1444AE	MU163020B/163040B operation manual: 1 copy	Not supplied when Pulse Pattern Generator Unit purchased as same time
	<b>Peripherals</b>	
J0776D	Coaxial cord (BNC-P-3W*3D-2W*BNC-P-3W), 2 m	Double shield
J0824	BNC multi-core cable, (16 pins), 1 m	
J0825	BNC multi-core cable, (9 pins), 1 m	
J0826	SMA multi-core cable, (16 pins), 1 m	
J0827	SAM multi-core cable, (9 pins), 1 m	
J0858	SMA multi-core cable, (16 pins), 2 m	
J0859	SMA multi-core cable, (9 pins), 2 m	
J0860	BNC multi-core cable, (16 pins), 2 m	
J0861	BNC multi-core cable, (9 pins), 2 m	

\*1 : Factory option

\*2 : Requires multi-core cable shown in peripherals (sold separately) for measurements

Microsoft is registered trademark of Microsoft Corporation.

Microsoft Windows is a registered trademark of Microsoft Corporation.

Windows is an abbreviation for Microsoft Windows Operating System.

Other product names used in this brochure are registered trademarks or products of their respective owners or manufactures.

# Anritsu

Specifications are subject to change without notice.

## ANRITSU CORPORATION MEASUREMENT SOLUTIONS

5-10-27, Minamiazabu, Minato-ku, Tokyo 106-8570, Japan  
Phone: +81-3-3446-1111  
Telex: J34372  
Fax: +81-3-3442-0235

Overseas Subsidiaries

### ● U.S.A.

#### ANRITSU COMPANY

#### North American Region Headquarters

1155 East Collins Blvd., Richardson, Tx 75081, U.S.A.  
Toll Free: 1-800-ANRITSU (267-4878)  
Phone: +1-972-644-1777  
Fax: +1-972-671-1877

### ● Canada

#### ANRITSU ELECTRONICS LTD.

Unit 102, 215 Stafford Road West  
Nepean, Ontario K2H 9C1, Canada  
Phone: +1-613-828-4090  
Fax: +1-613-828-5400

### ● Brasil

#### ANRITSU ELETRÔNICA LTDA.

Praia de Botafogo 440, Sala 2401 CEP 22250-040,  
Rio de Janeiro, RJ, Brasil  
Phone: +55-21-5276922  
Fax: +55-21-537-1456

### ● U.K.

#### ANRITSU LTD.

200 Capability Green, Luton, Bedfordshire LU1 3LU, U.K.  
Phone: +44-1582-433200  
Fax: +44-1582-731303

### ● Germany

#### ANRITSU GmbH

Grafenberger Allee 54-56, 40237 Düsseldorf, Germany  
Phone: +49-211-96855-0  
Fax: +49-211-96855-55

### ● France

#### ANRITSU S.A.

9, Avenue du Québec Z.A. de Courtabœuf 91951 Les  
Ullis Cedex, France  
Phone: +33-1-60-92-15-50  
Fax: +33-1-64-46-10-65

### ● Italy

#### ANRITSU S.p.A.

Via Elio Vittorini, 129, 00144 Roma EUR, Italy  
Phone: +39-06-509-9711  
Fax: +39-06-502-24-25

### ● Sweden

#### ANRITSU AB

Botvid Center, Fittja Backe 1-3 145 84 Stockholm,  
Sweden  
Phone: +46-853470700  
Fax: +46-853470730

### ● Singapore

#### ANRITSU PTE LTD.

6, New Industrial Rd., #06-01/02, Hoe Huat Industrial  
Building, Singapore 536199  
Phone: +65-282-2400  
Fax: +65-282-2533

### ● Hong Kong

#### ANRITSU COMPANY LTD.

Suite 719, 7/F., Chinachem Golden Plaza, 77 Mody  
Road, Tsimshatsui East, Kowloon, Hong Kong, China  
Phone: +852-2301-4980  
Fax: +852-2301-3545

### ● Korea

#### ANRITSU CORPORATION

14F Hyun Juk Bldg. 832-41, Yeoksam-dong,  
Kangnam-ku, Seoul, Korea  
Phone: +82-2-553-6603  
Fax: +82-2-553-6604-5

### ● Australia

#### ANRITSU PTY LTD.

Unit 3/170 Forster Road Mt. Waverley, Victoria, 3149,  
Australia  
Phone: +61-3-9558-8177  
Fax: +61-3-9558-8255

### ● Taiwan

#### ANRITSU COMPANY INC.

6F, 96, Sec. 3, Chien Kou North Rd. Taipei, Taiwan  
Phone: +886-2-2515-6050  
Fax: +886-2-2509-5519





## Artisan Technology Group is your source for quality new and certified-used/pre-owned equipment

- FAST SHIPPING AND DELIVERY
- TENS OF THOUSANDS OF IN-STOCK ITEMS
- EQUIPMENT DEMOS
- HUNDREDS OF MANUFACTURERS SUPPORTED
- LEASING/MONTHLY RENTALS
- ITAR CERTIFIED SECURE ASSET SOLUTIONS

### SERVICE CENTER REPAIRS

Experienced engineers and technicians on staff at our full-service, in-house repair center

### *InstraView*<sup>SM</sup> REMOTE INSPECTION

Remotely inspect equipment before purchasing with our interactive website at [www.instraview.com](http://www.instraview.com) ↗

### WE BUY USED EQUIPMENT

Sell your excess, underutilized, and idle used equipment. We also offer credit for buy-backs and trade-ins. [www.artisanng.com/WeBuyEquipment](http://www.artisanng.com/WeBuyEquipment) ↗

### LOOKING FOR MORE INFORMATION?

Visit us on the web at [www.artisanng.com](http://www.artisanng.com) ↗ for more information on price quotations, drivers, technical specifications, manuals, and documentation

**Contact us:** (888) 88-SOURCE | [sales@artisanng.com](mailto:sales@artisanng.com) | [www.artisanng.com](http://www.artisanng.com)