



## Artisan Technology Group is your source for quality new and certified-used/pre-owned equipment

- FAST SHIPPING AND DELIVERY
- TENS OF THOUSANDS OF IN-STOCK ITEMS
- EQUIPMENT DEMOS
- HUNDREDS OF MANUFACTURERS SUPPORTED
- LEASING/MONTHLY RENTALS
- ITAR CERTIFIED SECURE ASSET SOLUTIONS

### SERVICE CENTER REPAIRS

Experienced engineers and technicians on staff at our full-service, in-house repair center

### *InstraView*<sup>SM</sup> REMOTE INSPECTION

Remotely inspect equipment before purchasing with our interactive website at [www.instraview.com](http://www.instraview.com) ↗

### WE BUY USED EQUIPMENT

Sell your excess, underutilized, and idle used equipment. We also offer credit for buy-backs and trade-ins. [www.artisanng.com/WeBuyEquipment](http://www.artisanng.com/WeBuyEquipment) ↗

### LOOKING FOR MORE INFORMATION?

Visit us on the web at [www.artisanng.com](http://www.artisanng.com) ↗ for more information on price quotations, drivers, technical specifications, manuals, and documentation

**Contact us:** (888) 88-SOURCE | [sales@artisanng.com](mailto:sales@artisanng.com) | [www.artisanng.com](http://www.artisanng.com)

# APC Smart-UPS Uninterruptible Power Supply

## Model 5000I User's Manual

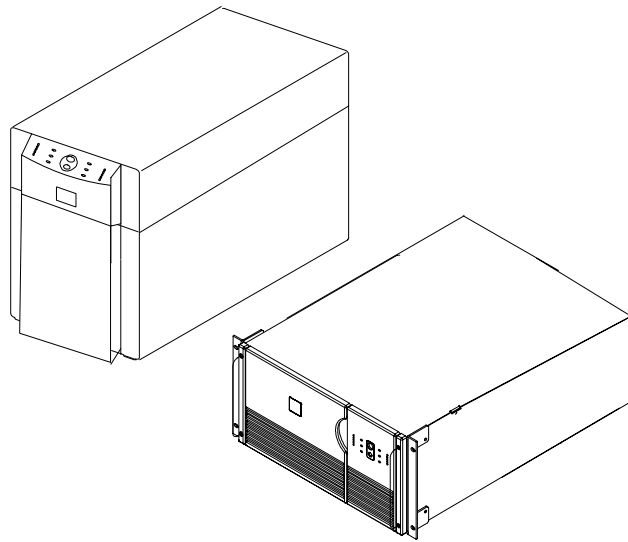

**APC**  
[www.apcc.com](http://www.apcc.com)

Entire contents copyright ©1999 by American Power Conversion. All rights reserved. Reproduction in whole or in part without permission is prohibited. Smart-UPS is a registered trademark of APC. All other trademarks are the property of their respective owners.

990-7032A, Revision 3 7/01

This Safety Guide contains important instructions that should be followed during installation and maintenance of the APC equipment and batteries. It is intended for APC customers who setup, install, relocate, or maintain APC equipment.

## Handling Safety

- Be careful. Do not lift heavy loads without assistance.

<18 kg (<40 lb.)

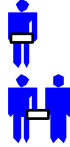

18-32 kg (40-70 lb.)



32-55 kg (70-120 lb.)



>55 kg (>120 lb.)





- Equipment with casters is built to move on a smooth surface without any obstacles.
- Do not use a ramp inclined at more than 10°.
- This equipment is intended for installation in a temperature-controlled indoor area (0 to 40°C (+32 to +104°F)), free of conductive contaminants.

## Electrical Safety

- Do not work alone under hazardous conditions.
- High short circuit current through conductive materials could cause severe burns.
- A licensed electrician is required to install permanently wired equipment.
- Check that the power cord(s), plug(s), and sockets are in good condition.
- To reduce the risk of electric shock when grounding cannot be verified, disconnect the equipment from the AC power outlet before installing or connecting to other equipment. Reconnect the power cord only after all connections are made.
- Do not handle any kind of metallic connector before the power has been removed.
- Use one hand, whenever possible, to connect or disconnect signal cables to avoid a possible shock from touching two surfaces with different electrical grounds.
- Connect the equipment to a three wire AC outlet (two poles plus ground). The receptacle must be connected to appropriate branch circuit/mains protection (fuse or circuit breaker). Connection to any other type of receptacle may result in a shock hazard.



### CAUTION! Deenergizing Safety

- If the equipment has an internal energy source (the battery), the output may be energized when the unit is not connected to an AC power outlet.
- To deenergize **pluggable equipment**: first press the Off button for more than one second to switch the equipment off. Next disconnect the equipment from the AC power outlet. Finally, disconnect the battery.
- To deenergize **permanently wired** equipment: set the power switch to standby . Next set the AC circuit breaker to standby . Then disconnect the batteries (including any expansion units). Finally, disconnect the AC power from the building power supply.
- Pluggable equipment includes a protective earth conductor which carries the leakage current from the load devices (computer equipment). Total leakage current must not exceed 3.5 mA.
- Use of this equipment in life support applications where failure of this equipment can reasonably be expected to cause the failure of the life support equipment or to significantly effect its safety or effectiveness is not recommended.



### WARNING! Battery Safety

- **This equipment contains potentially hazardous voltages.** Do not attempt to disassemble the unit. The **only exception** is for equipment containing batteries. Battery replacement using the procedures below is permissible. Except for the battery, the unit contains no user serviceable parts. Repairs are performed only by factory trained service personnel.



**Batteries must be recycled.** Deliver the battery to an appropriate recycling facility or ship it to the supplier in the new battery's packing material. See the new battery instructions for more information.

- Do not dispose of batteries in a fire. The batteries may explode.
- Do not open or mutilate batteries. They contain an electrolyte which is toxic and harmful to the skin and eyes.
- To avoid personal injury due to energy hazard, remove wrist watches and jewelry such as rings when replacing the batteries. Use tools with insulated handles.
- Replace batteries with the same number and type of batteries as originally installed in the equipment.

## Replacement and Recycling of Batteries

See your dealer or the Battery Replacement Section of this *User's Manual* for information on replacement battery kits and battery recycling.



# Table of Contents

Introduction .....	1
Unpacking .....	1
Installation.....	2
Initial Startup.....	6
Operating Instructions .....	8
Storage.....	9
Replacing the Battery .....	10
User Configuration Items .....	11
How to Determine On-Battery Run Time.....	11
Specifications .....	12
Regulatory Agency Approvals.....	13
Troubleshooting .....	14
Service.....	15
Limited Warranty .....	15
APC Contact Information.....	15
Appendix A: Types of Racks and Mounting Hardware.....	16
Racks .....	16
Appendix B: Transporting Your Smart-UPS.....	17



# Introduction

## About Your New UPS

This Uninterruptible Power Supply (UPS) is designed to prevent blackouts, brownouts, sags and surges from reaching your computer and other valuable electronic equipment. This UPS also filters out small utility line fluctuations and isolates your equipment from large disturbances by internally disconnecting from the utility line, while supplying power from its internal batteries until the utility line returns to safe levels.

While running on battery, an internal alarm will sound (periodic beeps). The on/test button may be pressed to silence the UPS alarm.

If the utility power does not return, the UPS will continue supplying power to the connected equipment until exhausted. A continuous beeping will sound two minutes before the UPS's final low battery shutdown. If using a computer, you must manually save your files and power down before the UPS turns itself off, unless you are using PowerChute® interface software that provides automatic, unattended shutdown.

# Unpacking

## Inspection







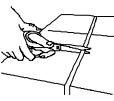

Inspect the UPS upon receipt. Notify the carrier and dealer if there is damage. The packaging is recyclable; save it for reuse or dispose of it properly.

## Contents

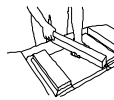
The shipping package contains the UPS, its batteries (four battery packs), six IEC jumper cords, and, for rack mount units, rails to support the unit in a rack.

## How to Unpack the UPS

Move the UPS, in its shipping package, as close to the desired location as possible. Then follow these instructions:

- |          |  |          |  |
|----------|--|----------|--|
| <b>1</b> |    | <b>2</b> |    |
|          | Use scissors or a knife to cut the plastic straps and open the package.  |          | Read this <i>User's Manual</i> for safety information and installation instructions. |
| <b>3</b> |   | <b>4</b> |   |
|          | Unpack the box containing the mounting rails.  |          | Remove the foam spacers.   |
| <b>5</b> |   | <b>6</b> |   |
|          | Lift off the cardboard box that covers the top and sides of the package. The bottom of the box is formed by a wooden pallet. |          | Pull the plastic bag down to expose the UPS.   |
| <b>7</b> |   | <b>8</b> |   |
|          | Lift the UPS up and out of the box.  |          | Remove the batteries from the pallet.  |

### Caution:

The 5000 VA model requires two or more people to lift due to its weight.



# Installation

Installing your UPS requires six steps:

1. Position the UPS in the desired location. For rack mount units this may include installing the rails into the rack.
2. Hardwire the electrical connection on the input side (must be done by an authorized electrician).
3. Install the batteries. This 5000 VA UPS ships without the batteries installed.
4. Connect equipment to the UPS.
5. Power up the UPS.
6. Install PowerChute® UPS monitoring software and accessories.

## 1. Position the UPS

### Placement

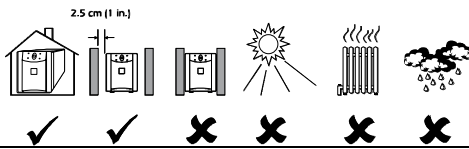

Install the UPS in a protected area that is free of excessive dust and has adequate air flow. Do not operate the UPS where the temperature and humidity are outside the specified limits.

### Warning!

Changes or modifications to this unit not expressly approved by the party responsible for compliance could void the warranty.

### Installing Rack Mount Units

The Rack Mount UPS comes with standard 19" (46.5 cm) rack mount brackets (ears) installed. It is supplied with L channel supports. These supports must be used with this model to ease installation for a 19" rack.

### Caution:

Remove the UPS before moving the rack.

Installing the UPS in a rack involves a four-step process:

1. Determine the location of the UPS in the rack.
2. Install the mounting rails in the rack.
3. Load the UPS into the rack.
4. Attach the mounting brackets to the rack.

This section describes each step in detail.

#### *Determine the Location of the UPS in the Rack*

- UPSs are heavy. Select a rack location sturdy enough to handle the weight. Mount the UPS at or near the bottom of the rack.
- Select a rack location with adequate air flow that is free from excessive dust. Ensure that any air vents on the sides of the UPS are not blocked. Do not operate the UPS where temperature or humidity are outside the limits listed under *Specifications*, page 12.

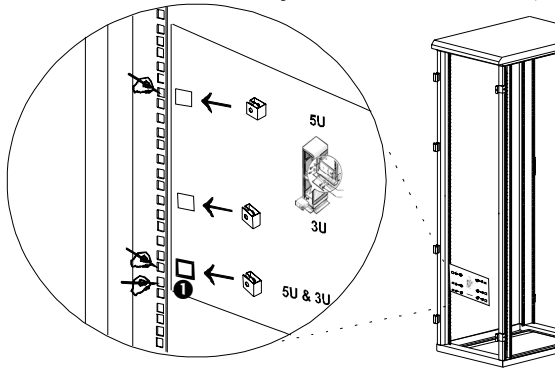

**Determine the Location of the UPS in the Rack (continued)**

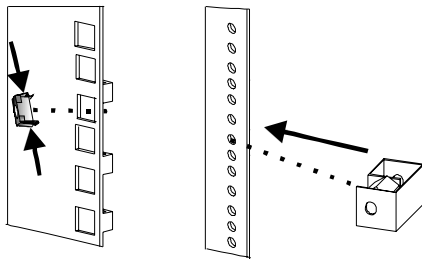

1. Determine where in the rack you'll mount the UPS. The SU5000 requires a space of 5U. Some racks have tick marks to indicate the U-spaces.
2. Using the mounting template provided (part number 990-0195), identify and mark the correct mounting holes for the UPS mounting brackets.
3. Locate and mark the bottom hole in the designated U-space ❶. The bottom screw on the mounting rail will attach to the bottom hole in the U-space.
4. Repeat steps 3 and 4 for the remaining three rack posts.
5. Prepare the rack holes, if necessary. Racks with threaded holes require no preparation.



If your rack has round holes, insert clip nuts  (provided) into the holes in step 2.

If your rack has square holes, insert either clip  or cage  nuts into the holes marked in step 2 (cage nut shown).

**Install the Mounting Rails in the Rack**

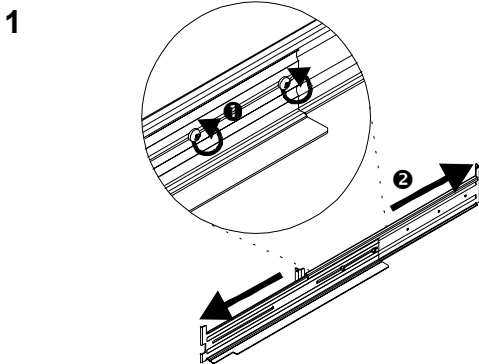

Remove the two screws ❶ that hold the rails together so that the rails can slide outward ❷. Do not detach the rails.

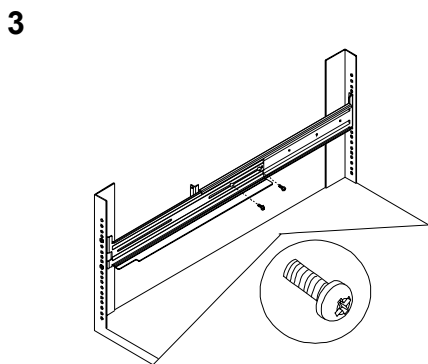

Expand the rails so that it spans from the front rack post to the back rack post. Replace the two screws (removed in step 1) that hold the rail sections together.

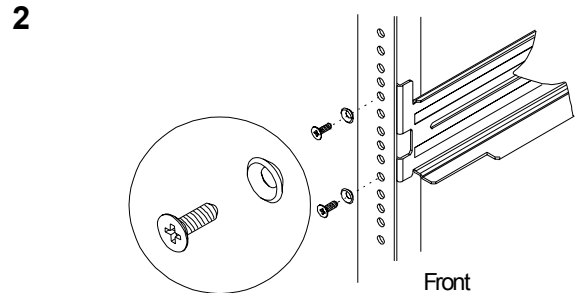

Align the bottom on the mounting rail with the bottom hole in the U-space (marked in step 3 above). Use the flat, Phillips head screws (10-32) and conical washers to attach the front rail to the rack. Position the rails so that the lip of the rail is on the bottom.

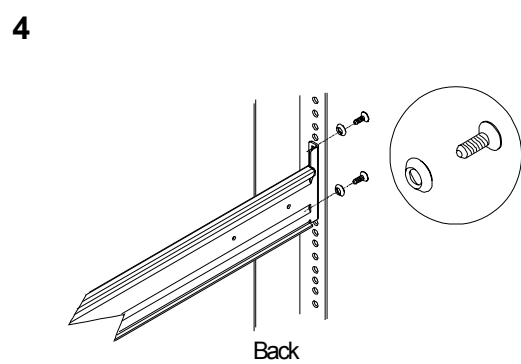

Attach the rail to the back rack post using the same hardware (10-32 flat head screws and conical washers) used in step 2. Repeat the process for the other rails.

**Caution:**

The 5000 VA models (without batteries installed) require two people to lift due to their weight.

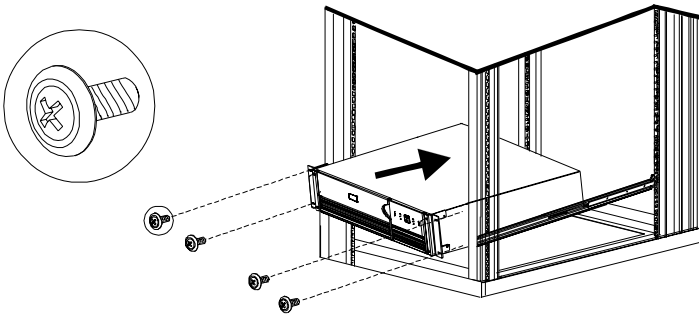

**Load the UPS into the Rack**

Supporting the UPS from the front and back, carefully align the unit with the rails. Slide the UPS into position.

**Attach the Mounting Brackets to the Rack**

Use the ornamental screws supplied with the UPS to attach the mounting brackets to the rack post.

## 2. Hardwire the Electrical Connection

**Caution:**

The electrical connection must be made by an authorized electrician according to national and local regulations. Verify that the supply line contains a 25 Amp circuit breaker BEFORE hardwiring the UPS.

Ensure that the batteries are not installed in the UPS until the hardwiring is complete.

Incorporate a readily accessible disconnect device in the fixed wiring design.

1. Select the appropriate wire size and connectors. For most applications, #10 AWG (5 sq. mm) wire should be sufficient.
2. The input wiring terminal is located on the rear panel of the UPS. Remove the access door by unscrewing the single screw which holds it in place.

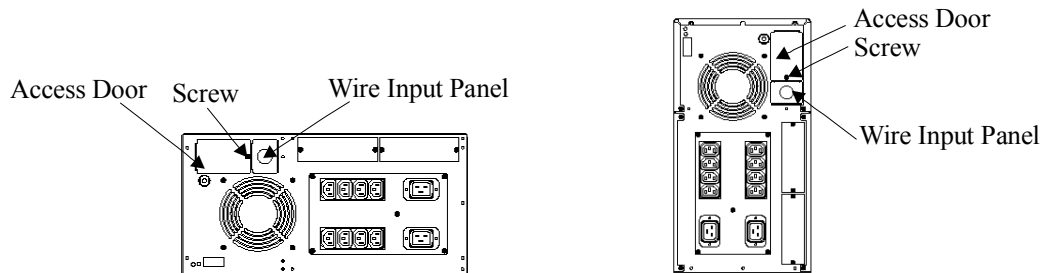

3. Slide the wire input plate to the left on rack mount units and up on towers and remove it. This will expose the input wiring terminal.
4. Use a screwdriver or any hard object to detach the circular knockout. You may need to use pliers to fully detach the knockout.
5. Feed the wire cable through the hole in the wire input plate. Using a threaded lock nut, fasten the plate to the selected cable or conduit connector.
6. Use a knife or pliers to strip off the plastic on the end of the cable to expose the copper wire. Strip all three wires.
7. Use a flathead screwdriver to connect the wires to the terminal block inside the UPS. Loosen the screw, then feed the copper wire into the terminal block and tighten the screw. Connect the protective earth ground to the terminal block at the position marked with the ground symbol ( $\perp$ ). The UPS wiring color code is:  
GREEN for GROUND  
WHITE for NEUTRAL  
BLACK for HOT
8. Once all the wires are connected to the terminal block, reconnect the wire input plate to the UPS. Align the plate, position it into the grooves, and slide it to the right.
9. Inspect the connections and location of the excess wires before installing the access door.
10. Replace the access door and fasten with the screw (removed in step 2).

### 3. Install the Batteries

The battery compartment is accessed from the front panel of the UPS. The 5000 VA unit requires four battery packs (each pack consists of four individual batteries).

**Note:**  
**Graphics are not drawn to scale. They are shown for reference only.**

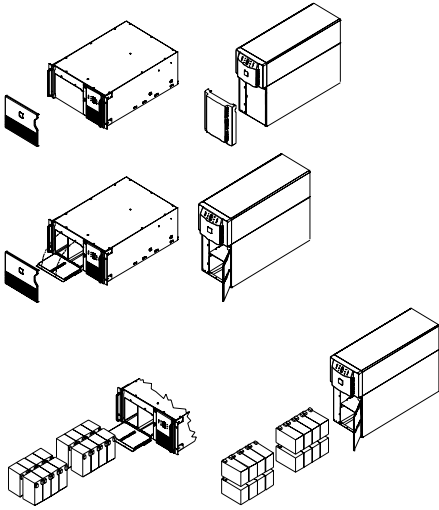

1. Remove the front bezel by grasping the finger clips on the side of the bezel and carefully loosening the four (4) snaps.
2. Use a screwdriver or coin to remove the two battery door screws and open the door.
3. For rack mount units, hold a battery pack so its battery leads are on the right hand side and slide it into the UPS. For tower units, hold the battery such that the battery leads are on the top and slide it into the UPS. Push the battery pack to the back of the compartment.

**Note:**  
**Be careful lifting the batteries – they are heavy. Support the bottom of the batteries as you move them.**

4. Connect the battery leads to the UPS connector within the battery compartment.

**Note:**  
**Small sparks at the battery connectors are normal during connection.**

5. Tuck the white cord (that serves as a handle for the connector) neatly to the side.
6. Repeat steps 3 through 5 to add the remaining battery packs.

### 4. Connect Power and Equipment to the UPS

- The UPS package includes six IEC jumper cords. Use these cords to connect your equipment to the UPS.
- Do not plug laser printers into the UPS.

**Caution:**  
**DO NOT use a standard serial interface cable to connect to the Computer Interface Port on the UPS. Standard serial interface cables are incompatible with the UPS connector. Use the cable provided with your UPS.**

- Turn on all connected equipment.

### 5. Connect Power to the UPS

- Press the UPS's ON switch to turn on your UPS. This will power-up connected equipment.
- The unit performs a self-test automatically when turned on, and every two weeks thereafter.
- The UPS charges its battery whenever it is connected to utility power. The battery charges fully during the first four hours of normal operation. Do not expect full runtime during this initial charge period.

### 6. Install PowerChute and Accessories

For additional computer system security, install PowerChute UPS monitoring software. It provides automatic unattended shutdown capabilities on most major network operating systems. Once PowerChute is loaded, install the PowerChute<sup>®</sup> black communication cable between UPS and computer. See the *Software Installation: Instruction Sheet* for details.

**Notes:**  
**This UPS is equipped with two SmartSlots for accessories. See the APC website ([www.apcc.com](http://www.apcc.com)) for available accessories. If a standard accessory is installed in this UPS, a User's Manual for the accessory is included.**

# Initial Startup

## Rear Views

5000 VA Tower Model

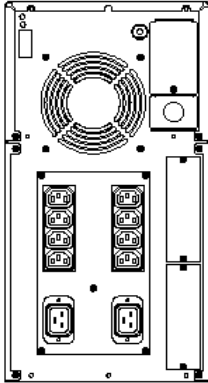

5000 VA Rack Mount Model

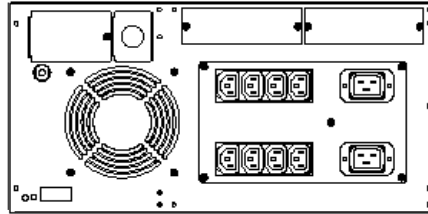

### Charge the battery

The UPS charges its battery whenever it is connected to utility power. The battery will charge fully during the first four hours of normal operation. Do not expect full runtime during this initial charge period.

### Connect Computer Interface Port (Optional)

Power management software and interface kits can be used with this UPS. Use only kits supplied or approved by the manufacturer. If used, connect the interface cable to the 9-pin computer interface port on the back panel of the UPS. Secure the connector's screws to complete the connection.

#### Caution:

**DO NOT use a standard serial interface cable to connect to the Computer Interface Port on the UPS. Standard serial interface cables are incompatible with the UPS connector. Use the cable provided with your UPS.**



### Connect Ground Leads to TVSS Connector (Optional)

The UPS features a TVSS connector for connecting the ground lead on transient voltage surge-suppression (TVSS) devices such as telephone and network line protectors. The TVSS connector provides grounding through the UPS's power cord ground conductor. To make a connection to the TVSS connector, loosen the screw and connect the surge suppression device's ground lead. Tighten the screw to secure the lead.

## Voltage Sensitivity

The UPS detects line voltage distortions such as spikes, notches, dips, and swells, as well as distortions caused by operation with inexpensive fuel-powered generators. By default, the UPS reacts to distortions by transferring to on-battery operation to protect the loads. Where power quality is poor, the UPS may frequently transfer to on-battery operation. If the loads can operate normally under such conditions, battery capacity and service life may be conserved by reducing the sensitivity of the UPS.

 To reduce UPS sensitivity, press the configuration button on the rear panel. Use a pointed object such as a pen to press the button. Press it once to set the UPS's sensitivity to **reduced**. Press it again to set the sensitivity to **low**. Press the button a third time to reset **normal** sensitivity.

-  normal When the UPS is set to normal sensitivity, the configuration LED is brightly lit.
-  reduced When it is set to reduced sensitivity, the LED is dimly lit.
-  low When it is set to low sensitivity, the LED is off.

## Low Battery Warning Interval

By default, the low battery warning occurs when there are approximately two minutes of on-battery run time remaining. This may not be enough time to gracefully shut down some protected computer systems.

☉ To change the warning interval, press the rear panel configuration button while pressing and holding the front-panel on/test button.

☉ 2 min. The initial setting.

☉ 5 min. Press the configuration button once to set the low battery warning interval to approximately five minutes.

● 7 min. Press it again to set the interval to approximately seven minutes.  
Press the button a third time to reset the interval to two minutes.



# Operating Instructions

## Switch On — Switch Off

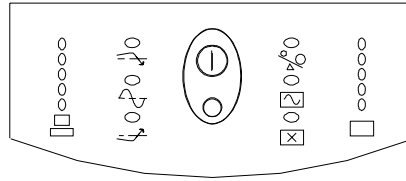

① With the UPS plugged in, press and release the large upper on/test button to supply power to the loads. The loads are immediately powered while the UPS beeps and performs a self-test.

○ Press and release the small, lower off button to turn off power to the loads. It may be convenient to use the UPS as a master on/off switch for the protected equipment.





**Note: Whenever the UPS is plugged in and utility voltage is present, the charger maintains battery charge.**

 The on-line LED illuminates when the UPS is supplying utility power to the loads.

## On Battery

During on-battery operation, the on-battery LED illuminates and the UPS sounds an audible alarm consisting of four beeps every 30 seconds. The alarm stops when the UPS returns to on-line operation.

## Battery Charge Bar Graph

 100%  
 80%  
 60%  
 40%  
 20%

The 5-LED display on the right of the front panel shows the present charge of the UPS's battery as a percentage of the battery's capacity. When all five LEDs light, the battery is fully charged. The top LED goes out whenever the battery is not 100% charged. When the lowest LED is flashing, the battery can supply less than two minutes of run time for the load.

## Shutdown Mode

In shutdown mode the UPS stops supplying power to the load, waiting for the return of utility power. If there is no utility power present, external devices (e.g., servers) connected to the computer interface or the accessory slot can command the UPS to shut down. This is normally done to preserve battery capacity after the graceful shutdown of protected servers. The UPS will scroll the front panel indicators sequentially in shutdown mode.

## Self-test

The UPS performs a self-test automatically when turned on, and every two weeks thereafter (by default). Automatic self-test eases maintenance requirements by eliminating the need for periodic manual self-tests.

During the self-test, the UPS briefly operates the loads on-battery. If the UPS passes the self-test, it returns to on-line operation.

 If the UPS fails the self-test it immediately returns to on-line operation and lights the replace battery LED.

The loads are not affected by a failed test. Recharge the battery overnight and perform the self-test again. If the replace battery LED is still on, replace the battery using the procedure in *Replacing the Battery*, page 10.

## Replace Battery

If the battery fails a self-test, the UPS emits short beeps for one minute and the replace battery LED illuminates. The UPS repeats the alarm every five hours. Perform the self-test procedure to confirm replace battery conditions. The alarm stops when the battery passes the self-test.

## Load Bar Graph

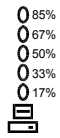

The 5-LED display on the left of the front panel represents the power drawn from the UPS as a percentage of total capacity. For example, if three LEDs are lit, the load is drawing between 50% and 67% of the UPS's capacity. If all five LEDs light, thoroughly test your complete system to make sure that the UPS will not become overloaded.

### Overload

When the UPS is overloaded (when the connected loads exceed the maximum specified in the “maximum load” section under *Specifications*, page 12), the overload LED comes on and the UPS emits a sustained tone. The alarm remains on until the overload is removed. Disconnect nonessential load equipment from the UPS to eliminate the overload.

### SmartTrim

The SmartTrim LED comes on to indicate that the UPS is compensating for a high voltage.

### SmartBoost

The SmartBoost LED comes on to indicate that the UPS is compensating for a low voltage.

## Low Battery

When the UPS is operating on-battery and the energy reserve of the battery runs low, the UPS beeps continuously until the UPS shuts down from battery exhaustion or returns to on-line operation.

## Cold Start

When the UPS is off and there is no utility power, use the cold start feature to apply power to the loads from the UPS's battery.

**Note:**

**Cold start is *not* a normal condition.**

-  Press and hold the on/test button until the UPS beeps.
- Release the on/test button during the beep and the loads are powered within four seconds.

**Note:**

**The UPS starts a self-test as a part of this procedure. The self-test does not affect the voltage display. The utility voltage bar graph has a margin of error of  $\pm 4\%$ .**

## Storage

### Storage Conditions

Store the UPS covered and upright in a cool, dry location, with its battery fully charged. Before storing, charge the UPS for at least two hours. Remove any accessories in the accessory slot and disconnect any cables connected to the computer interface port to avoid unnecessarily draining the battery.

### Extended storage

At -15 to +30 °C (+5 to +86 °F), charge the UPS's battery every six months.

At +30 to +45 °C (+86 to +113 °F), charge the UPS's battery every three months.



## Replacing the Battery

This UPS has an easy to replace hot-swappable battery. The battery compartment is located on the front panel for easy access. Battery replacement is a safe procedure, isolated from electrical hazards. You may leave the UPS and loads on for the following procedure. See your dealer or call the number in this manual for information on replacement battery cartridges.

**Note:**

Please read the cautions in *Smart UPS Safety Guide*, at the front of this manual. Once the battery is disconnected, the loads are not protected from power outages.

Model #	Replacement Battery Cartridge (RBC) #
SU5000I	RBC 12
SU5000RMI5U	RBC 12

**Note:**

Graphics are not drawn to scale. They are shown for reference only.

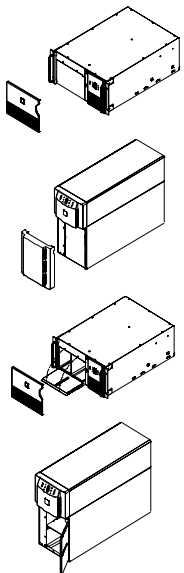

1. Remove the front bezel by grasping the finger clips on the side of the bezel and carefully loosening the four (4) snaps.
2. Use a screwdriver or coin to remove the two battery door screws and open the door.
3. Disconnect the front battery pack. Grip the white cord on the first front set of batteries and pull firmly to disconnect the connector from the battery compartment.
4. Pull the front battery out of the UPS by pulling the clear label, *not* the white cord. The white cord is connected to the battery leads, not the body of the battery.
5. Disconnect and remove the remaining battery packs by repeating steps 2 and 3.

**Notes:**

Be careful removing the batteries - they are heavy. Support the bottom of the batteries as you remove them.

The 5000 VA model has two stacked sets of batteries. Exercise special care when removing the top set.

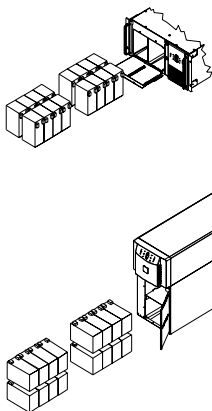

6. Replace the back battery pack. For rack mount units, hold a battery pack so its battery leads are on the right-hand side and slide it into the UPS. For tower units, hold the battery such that the battery leads are on the top and slide it into the UPS. Push the battery pack to the back of the compartment.
7. Reconnect the battery pack by pressing the gray connector into the plug at the right-hand side (rack mount units) or top (tower units) of the battery housing.

**Note:**

Small sparks at the battery connectors are normal during connection.

8. Repeat steps 6 and 7 for the remaining battery packs.
9. Close the battery door, replace the screws, and replace the front cover.



**Batteries must be recycled.** Deliver the battery to an appropriate recycling facility or ship it to the supplier in the new battery's packing material. See the instructions included with the new battery for more information.

## User Configuration Items

Note: Setting these items requires optional software or hardware.			
Function	Factory Default	User Selectable Choices	Description
Automatic Self-Test	Every 14 days (336 hours)	Every 7 days (168 hours), On Startup Only, No Self-Test	Sets the interval at which the UPS will execute a self-test.
UPS ID	UPS_IDEN	Up to eight characters to define the UPS.	Use this field to uniquely identify the UPS for network management purposes.
Date of Last Battery Replacement	Manufacture Date	Date of Battery Replacement	Reset this date on battery replacement.
Minimum Capacity Before Return from Shutdown	0 percent	15, 50, 90 percent	The UPS will charge its batteries to the specified percentage before return from a shutdown.
Sensitivity	Normal	Reduced, Low	Set lower than normal sensitivity to avoid lowered battery capacity and service life in situations where the load can tolerate minor power disturbances.
Duration of Low Battery Warning	2 minutes	5, 7, 10 minutes	Sets the time before shutdown at which the UPS issues a low battery warning. Set higher than the default only if the OS needs the time for graceful shutdown.
Alarm Delay After Line Fail	5 second delay	30 second delay, At Low Battery Condition, No Alarm	To avoid alarms for minor power glitches, set the alarm delay.
Shutdown Delay	20 seconds	180, 300, 600 seconds	Sets the interval between when the UPS receives a shutdown command and when shutdown occurs.
Synchronized Turn-on Delay	0 seconds	60, 180, 300 seconds	To avoid branch circuit overload, the UPS will wait the specified time after the return of utility power before turn-on.
High Transfer Point	253	264, 271, 280	To avoid unnecessary battery usage, set the High Transfer Point higher if the utility voltage is chronically high and the load is known to work well under this condition.
Low Transfer Point	196	188, 204, 208	Set the Low Transfer Point lower if the utility voltage is chronically low and the load can tolerate this condition.

## How to Determine On-Battery Run Time

**Note:**  
UPS battery life differs based on usage and environment.

### Tower and 5U Rack Mount 5000 VA Models

Typical On-Battery Run Time Versus Load, in Hours	
Load	5000 VA Internal Battery
100 VA	7.17
150 VA	5.95
200 VA	5.04
300 VA	3.88
400 VA	2.96
500 VA	2.37
600 VA	1.92
800 VA	1.40
1000 VA	1.06
1200 VA	0.83
1400 VA	0.65
1600 VA	0.54
2000 VA	0.39
2200 VA	0.33
2500 VA	0.26
3000 VA	0.19
3500 VA	0.16
4000 VA	0.13
4500 VA	0.11
5000 VA	0.09

# Specifications

Acceptable input voltage	0 - 325 VAC
Output voltage	196 - 253 VAC
Input protection	Resettable circuit breaker
Frequency limits (on-line operation)	47 - 63 Hz
Transfer time	2 ms typical, 4 ms maximum
Maximum load, total	5000 VA/3750 W
On-battery output voltage	220, 225, 230, or 240 VAC
On-battery frequency	50 or 60 Hz, 0.1 Hz; unless synchronized to utility during brownout
On-battery waveshape	Low-distortion sine wave
Overload protection (on-battery)	Overcurrent and short-circuit protected, latching shutdown on overload
Noise filter	Normal and common mode EMI/RFI suppression, 100 kHz to 10 MHz
Battery type	Spill proof, maintenance free, sealed lead-acid
Typical battery life	3 to 6 years, depending on number of discharge cycles and ambient temperature
Typical recharge time	2 to 5 hours from total discharge
Operating temperature	0 to 40°C (+32 to +104°F)
Storage temperature	-15 to +45°C (+5 to +113°F)
Operating and storage relative humidity	0 to 95%, non-condensing
Operating elevation	0 to +3,000 m (0 to +10,000 ft.)
Storage elevation	0 to +15,000 m (0 to +50,000 ft.)
Electromagnetic Compatibility (EMC)	EN50091-2
Electromagnetic Interference (EMI)	EN55022 Class A
Electromagnetic Immunity	IEC 801-2, 801-3, 801-4, 801-5, 1000-2-2 EN60555-1, -2, -3, EN61000-4-1, EN61000-4-11
Audible noise in dBA at 1 m (3 ft.)	<55
Safety approvals	GS licensed by VDE to EN50091-1-1 and 60950
Rack Mount Units	<b>RM Unit</b>
Size (W x H x D)	43.2 x 19.6 x 62.2 cm (17.0 x 8.7 x 24.5 in.)
Weight - net (shipping)	205 (235) lb. 93 (106.6) kg
Tower Units	<b>Tower Unit</b>
Size (W x H x D)	19.6 x 43.2 x 62.2 cm (8.7 x 17.5 x 26.0 in.)
Weight - net (shipping)	200 (240) lb. 93 (106.6) kg

# Regulatory Agency Approvals



CE

2001

## EC Declaration of Conformity

We, the undersigned, declare under our sole responsibility that the equipment specified below conforms to the following standards and directives:

<b>Standards to Which Conformity Declared:</b>	EN50091-1, EN60950, EN50091-1-1, IEC60950 EN55022, EN50091-2, EN61000-3-2, EN61000-3-3 73/23/EEC, 93/68/EEC 89/336/EEC, 92/31/EEC, 91/157/EEC
<b>Application of Council Directives:</b>	Uninterruptible Power Supply SU5000I, SU5000RMI5U
<b>Type of Equipment:</b>	American Power Conversion 132 Fairgrounds Road West Kingston, Rhode Island, 02892, USA
<b>Model Numbers:</b>	-or- American Power Conversion (A. P. C.) b. v. Ballybritt Business Park Galway, Ireland
<b>Manufacturer's Name and Address:</b>	-or- American Power Conversion Main Avenue, Peza Rosario, Cavite, Philippines
	-or- American Power Conversion 2nd Street, Peza, Cavite Economic Zone Rosario, Cavite Philippines
	-or- American Power Conversion Lot 32 Phase I Carmelray Industrial Park Canlubang, Calamba, Laguna Philippines
	-or- APC (Suzhou) UPS Co., Ltd No. 189 Suhong Road, China-Singapore Suzhou Industrial Park Suzhou 215021, Jiangsu, P.R.C
<b>Importer's Name and Address:</b>	American Power Conversion (A. P. C.) b. v. Ballybritt Business Park Galway, Ireland
<b>Place:</b>	N. Billerica, MA U.S.  <i>Richard J. Everett</i> 5 Jan 01 Richard J. Everett, Sr. Regulatory Compliance Engineer
<b>Place:</b>	Galway, Ireland  <i>Ray S. Ballard</i> 5 Jan 01 Ray S. Ballard, Managing Director, Europe Phone: 353 917 02000 Fax: 353 9175 6909

## Troubleshooting

Use the chart below to solve minor UPS installation problems. Contact APC Technical Support Staff for assistance with complex UPS problems. See *APC Contact Information*, page 15, for a location near you.

Problem and Possible Cause	Solution
<p><b>UPS will not turn on.</b></p> <ul style="list-style-type: none"> <li>• ON button not pushed.</li> <li>• UPS not connected to AC power supply.</li> <li>• UPS input circuit breaker tripped.</li> <li>• Very low or no utility voltage.</li> <li>• Battery not connected properly.</li> </ul>	<p>Press the ON button once to power the UPS and the load.</p> <p>Check that the power cable from the UPS to the power supply is securely connected at both ends.</p> <p>Reduce the load on the UPS by unplugging equipment and reset the circuit breaker (on back of UPS) by pressing the plunger back in.</p> <p>Check the AC power supply to the UPS with a table lamp. If very dim, have the utility voltage checked.</p> <p>Confirm the battery connections.</p>
<p><b>UPS will not turn off.</b></p> <ul style="list-style-type: none"> <li>• Internal UPS fault.</li> </ul>	<p>Do not attempt to use the UPS. Unplug the UPS and have it serviced immediately.</p>
<p><b>UPS operates on-battery although normal line voltage exists.</b></p> <ul style="list-style-type: none"> <li>• UPS's input circuit breaker tripped.</li> <li>• Very high, low, or distorted line voltage. Inexpensive fuel powered generators can distort the voltage.</li> </ul>	<p>Reduce the load on the UPS by unplugging equipment and reset the circuit breaker (on back of UPS) by pressing the plunger back in.</p> <p>Move the UPS to a different outlet on a different circuit.</p> <p>Test the input voltage with the utility voltage display. If acceptable to the load, reduce the UPS's sensitivity. Refer to <i>Voltage Sensitivity</i>, page 6, for procedures.</p>
<p><b>UPS beeps occasionally.</b></p> <ul style="list-style-type: none"> <li>• Normal UPS operation.</li> </ul>	<p>None. The UPS is protecting the load.</p>
<p><b>UPS does not provide expected backup time.</b></p> <ul style="list-style-type: none"> <li>• The UPS's battery is weak due to recent outage or is near the end of its service life.</li> <li>• The UPS is overloaded.</li> </ul>	<p>Charge the battery. Batteries require recharging after extended outages. Also, they wear faster when put into service often or when operated at elevated temperatures. If the battery is near the end of its service life, consider replacing the battery even if the replace battery indicator is not yet lit.</p> <p>Check the UPS's load display. Unplug less needed equipment, such as printers.</p>
<p><b>Front panel indicators flash sequentially.</b></p> <ul style="list-style-type: none"> <li>• The UPS has been shut down by remote control.</li> </ul>	<p>None. The UPS will restart automatically when utility power returns.</p>
<p><b>All indicators are lit and UPS emits a constant beeping.</b></p> <ul style="list-style-type: none"> <li>• Internal UPS fault.</li> </ul>	<p>Do not attempt to use the UPS. Turn the UPS off and have it serviced immediately.</p>
<p><b>All indicators are off and UPS is plugged into wall outlet.</b></p> <ul style="list-style-type: none"> <li>• The UPS is shut down and the battery is discharged from an extended outage.</li> </ul>	<p>None. The UPS will return to normal operation when the power is restored and the battery has a sufficient charge.</p>
<p><b>The replace battery light is lit.</b></p> <ul style="list-style-type: none"> <li>• Weak batteries.</li> <li>• Replacement batteries not connected properly.</li> </ul>	<p>Do another self test to see if it clears.</p> <p>Confirm the battery connections.</p>

## Service

### If the UPS requires service do not return it to the dealer!

Follow these steps:

1. Review the problems discussed in *Troubleshooting*, page 14, to eliminate common problems.
2. Verify that no circuit breakers are tripped. A tripped circuit breaker is the most common UPS problem!
3. If the problem persists, call Customer Service or visit the APC Internet Website ([www.apcc.com](http://www.apcc.com)).
  - Note the model number of the UPS, the serial number, and the date purchased. A technician will ask you to describe the problem and try to solve it over the phone, if possible. If this is not possible the technician will issue a Returned Material Authorization Number (RMA#).
  - If the UPS is under warranty, repairs are free. If not, there is a repair charge.
4. Pack the UPS in its original packaging. If the original packing is not available, ask Customer Service about obtaining a new set.

**Note:**

**Pack the UPS properly to avoid damage in transit. Never use Styrofoam beads for packaging. Damage sustained in transit is not covered under warranty.**

5. Mark the RMA# on the outside of the package.
6. Return the UPS by insured, prepaid carrier to the address given to you by Customer Service.

## Limited Warranty

American Power Conversion (APC) warrants its products to be free from defects in materials and workmanship for a period of two years from the date of purchase. Its obligation under this warranty is limited to repairing or replacing, at its own sole option, any such defective products. To obtain service under warranty you must obtain a Returned Material Authorization (RMA) number from customer support (see the *Service* section of the *User's Manual*). Products must be returned with transportation charges prepaid and must be accompanied by a brief description of the problem encountered and proof of date and place of purchase. This warranty does not apply to equipment which has been damaged by accident, negligence, or misapplication or has been altered or modified in any way. This warranty applies only to the original purchaser who must have properly registered the product within 10 days of purchase.

EXCEPT AS PROVIDED HEREIN, AMERICAN POWER CONVERSION MAKES NO WARRANTIES, EXPRESSED OR IMPLIED, INCLUDING WARRANTIES OF MERCHANTABILITY AND FITNESS FOR A PARTICULAR PURPOSE. Some states do not permit limitation or exclusion of implied warranties; therefore, the aforesaid limitation(s) or exclusion(s) may not apply to the purchaser.

EXCEPT AS PROVIDED ABOVE, IN NO EVENT WILL APC BE LIABLE FOR DIRECT, INDIRECT, SPECIAL, INCIDENTAL, OR CONSEQUENTIAL DAMAGES ARISING OUT OF THE USE OF THIS PRODUCT, EVEN IF ADVISED OF THE POSSIBILITY OF SUCH DAMAGE. Specifically, APC is not liable for any costs, such as lost profits or revenue, loss of equipment, loss of use of equipment, loss of software, loss of data, costs of substitutes, claims by third parties, or otherwise.

## APC Contact Information

Internet [www.apc.com/support/contact](http://www.apc.com/support/contact)

# Appendix A: Types of Racks and Mounting Hardware

This appendix describes the hardware required for the different types of racks and describes the type of racks that may be used in your industry. All APC Rack Mount units are shipped ready for 19-inch wide EIA/IEC rack cabinets. Refer to the instructions included with the rails when mounting the UPS.

## Racks

There are different types of racks:

- Equipment Rack - usually an open rack with threaded mounting holes or no threaded holes
- APC Netshelter, IBM (Vero, others) - enclosed rack with square holes
- Dell, Compaq (Rittal) - enclosed rack with square holes
- HP Rack - enclosed rack with round holes

These racks differ in the methods required for mounting equipment. They may have threaded holes (hardware not included), round holes (require clip nut, shown below), or square holes (require cage nut, shown below).

- Telecomm Rack - open rack with two poles/four poles and threaded round holes (hardware not supplied by APC).

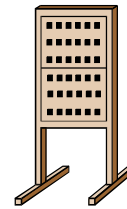
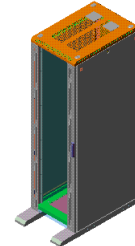

<b>Notes:</b>
<b>Remove batteries to reduce UPS weight.</b>
<b>For larger, heavier units, installation should be performed by two people.</b>

Check the type of rack you have against the hardware required for mounting in the table below.

Rack Type	Hole Type	Hardware Required	Hardware Included
Equipment Rack	Threaded or No Threads	See rack specifications if threaded. If not threaded use APC hardware.	N/A if threaded. If not threaded use APC hardware.
Netshelter/Compaq/IBM/Dell	Square	Cage nut, 10-32 screws	810-2008, 810-0002
HP	Round	Clip nut, 10-32 screws	810-2004, 810-0002
Telecomm	Threaded	See rack specifications	N/A

## Appendix B: Transporting Your Smart-UPS

Follow these guidelines if you need to ship the UPS to another location. These guidelines apply whether you are transporting the UPS alone, rack mounted in an equipment cabinet, or installed in a system.

### Caution:

**Always DISCONNECT THE BATTERIES before shipping the UPS to avoid damage during transport. (U.S. Federal Regulation *requires* that batteries be disconnected during shipment.) The batteries may remain in the UPS; they do not have to be removed.**

**This requirement applies whether the UPS is shipped alone or installed in an equipment rack or system.**

### Note:

**Graphics are not drawn to scale. They are shown for reference only.**

The battery compartment is accessed from the front panel of the UPS. The SU5000 unit has four battery packs (each with four individual batteries).

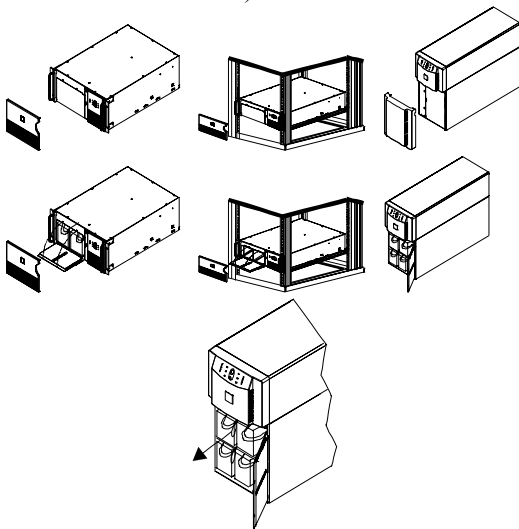

1. Remove the front bezel by grasping the finger clips on the side of the bezel and carefully loosening the four (4) snaps.
2. Use a screwdriver or coin to remove the two battery door screws and open the door.
3. Disconnect the front battery pack. Grasp the white cord on the first front set of batteries and pull firmly to disconnect the connector from the battery compartment.
4. Tuck the white cord (that serves as a handle for the connector) neatly to the side.
5. Disconnect the remaining battery packs by repeating steps 3 and 4.
6. Once all the batteries have been disconnected, close the battery door and replace the two (2) screws removed in step 2.
7. Align the front bezel with the opening on the front of the UPS and snap it into place.

### Note:

**Remember to connect the batteries once the SU5000 has arrived at its destination.**





## Artisan Technology Group is your source for quality new and certified-used/pre-owned equipment

- FAST SHIPPING AND DELIVERY
- TENS OF THOUSANDS OF IN-STOCK ITEMS
- EQUIPMENT DEMOS
- HUNDREDS OF MANUFACTURERS SUPPORTED
- LEASING/MONTHLY RENTALS
- ITAR CERTIFIED SECURE ASSET SOLUTIONS

### SERVICE CENTER REPAIRS

Experienced engineers and technicians on staff at our full-service, in-house repair center

### *InstraView*<sup>SM</sup> REMOTE INSPECTION

Remotely inspect equipment before purchasing with our interactive website at [www.instraview.com](http://www.instraview.com) ↗

### WE BUY USED EQUIPMENT

Sell your excess, underutilized, and idle used equipment. We also offer credit for buy-backs and trade-ins. [www.artisanng.com/WeBuyEquipment](http://www.artisanng.com/WeBuyEquipment) ↗

### LOOKING FOR MORE INFORMATION?

Visit us on the web at [www.artisanng.com](http://www.artisanng.com) ↗ for more information on price quotations, drivers, technical specifications, manuals, and documentation

**Contact us:** (888) 88-SOURCE | [sales@artisanng.com](mailto:sales@artisanng.com) | [www.artisanng.com](http://www.artisanng.com)