



Artisan Technology Group is your source for quality new and certified-used/pre-owned equipment

- FAST SHIPPING AND DELIVERY
- TENS OF THOUSANDS OF IN-STOCK ITEMS
- EQUIPMENT DEMOS
- HUNDREDS OF MANUFACTURERS SUPPORTED
- LEASING/MONTHLY RENTALS
- ITAR CERTIFIED SECURE ASSET SOLUTIONS

SERVICE CENTER REPAIRS

Experienced engineers and technicians on staff at our full-service, in-house repair center

*InstraView*SM REMOTE INSPECTION

Remotely inspect equipment before purchasing with our interactive website at www.instraview.com ↗

WE BUY USED EQUIPMENT

Sell your excess, underutilized, and idle used equipment. We also offer credit for buy-backs and trade-ins. www.artisanng.com/WeBuyEquipment ↗

LOOKING FOR MORE INFORMATION?

Visit us on the web at www.artisanng.com ↗ for more information on price quotations, drivers, technical specifications, manuals, and documentation

Contact us: (888) 88-SOURCE | sales@artisanng.com | www.artisanng.com

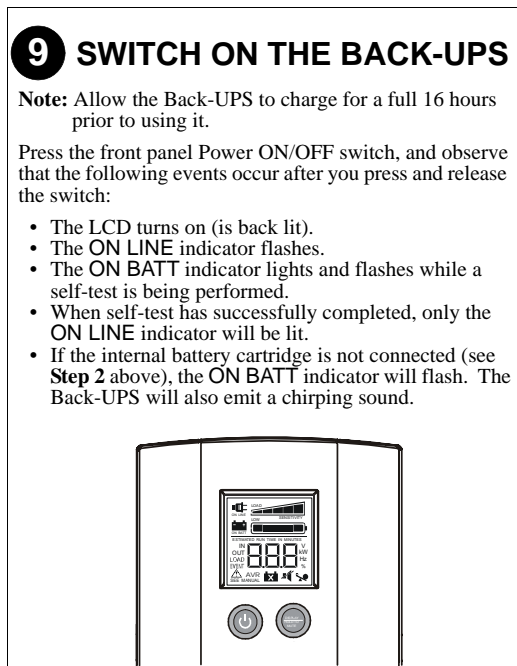
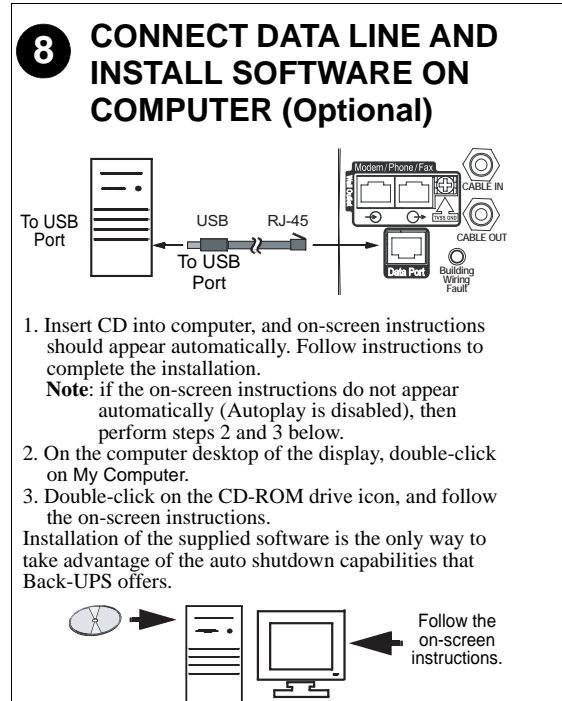
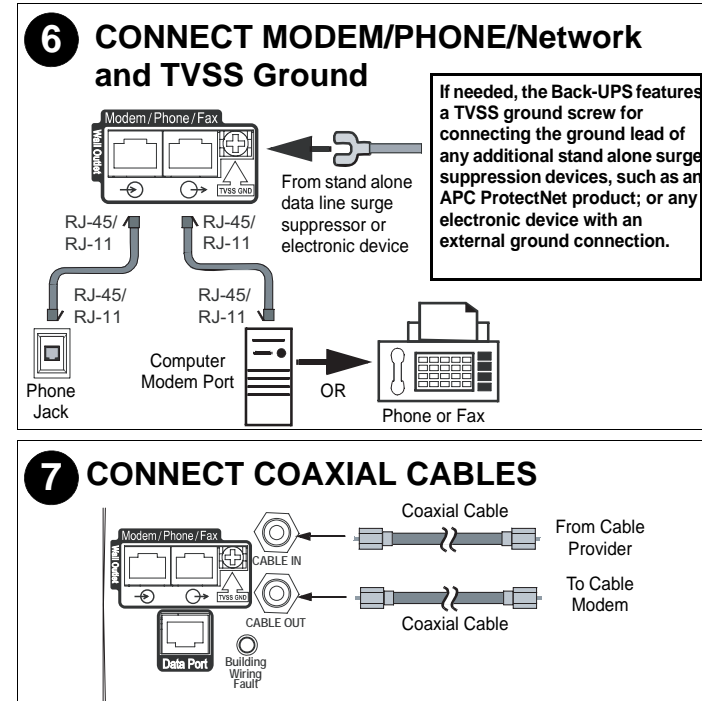
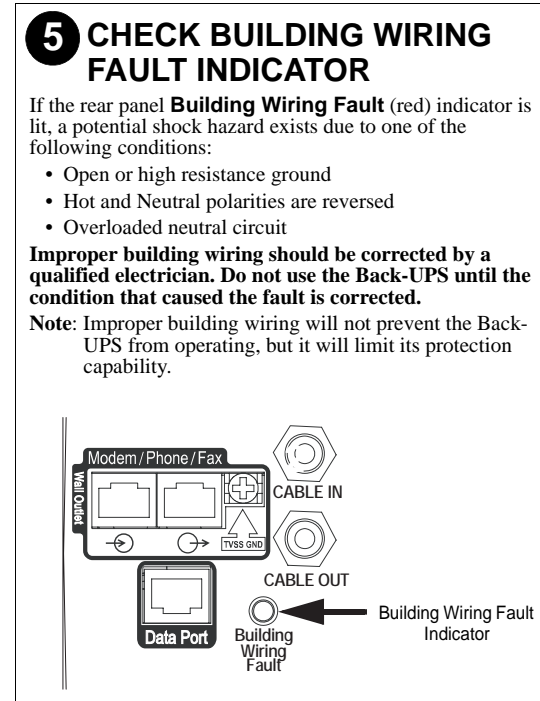
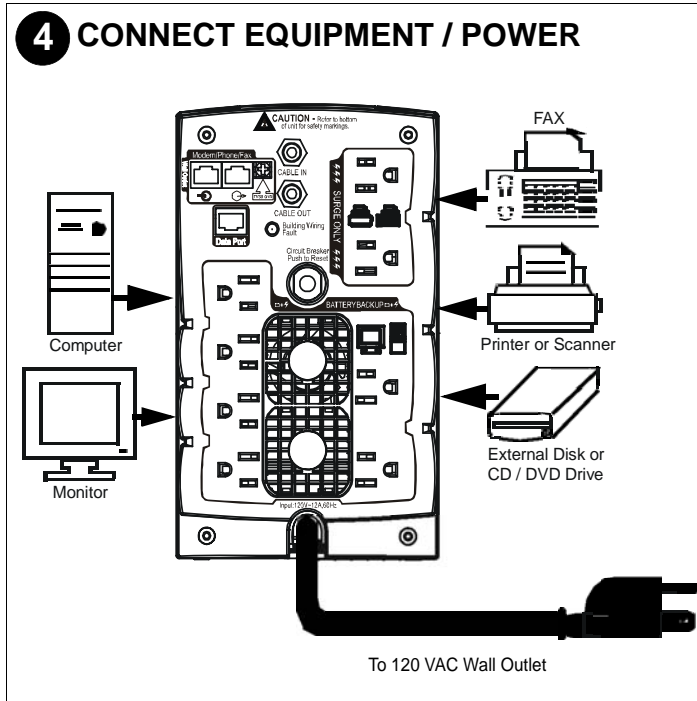
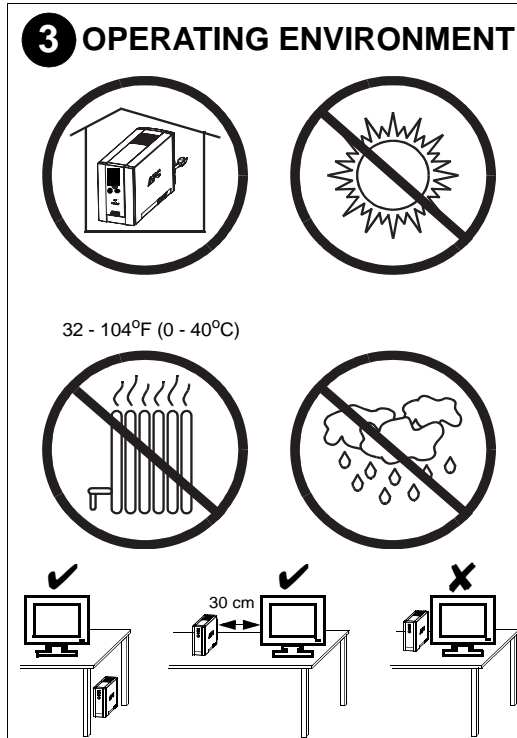
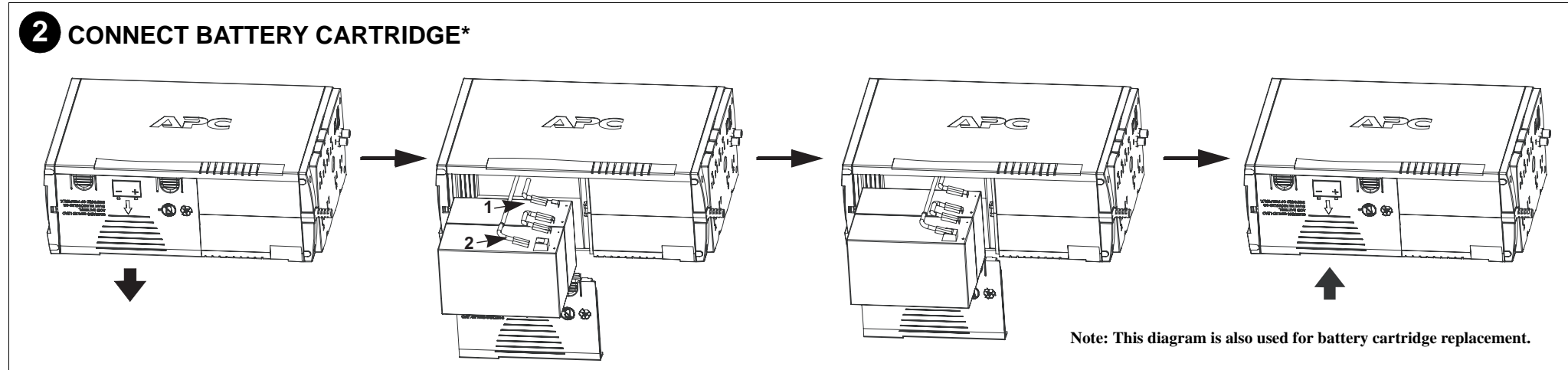
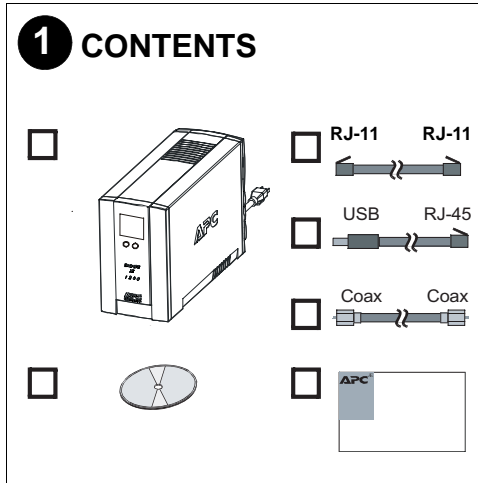

LCD INDICATORS and CONTROLS SUMMARY

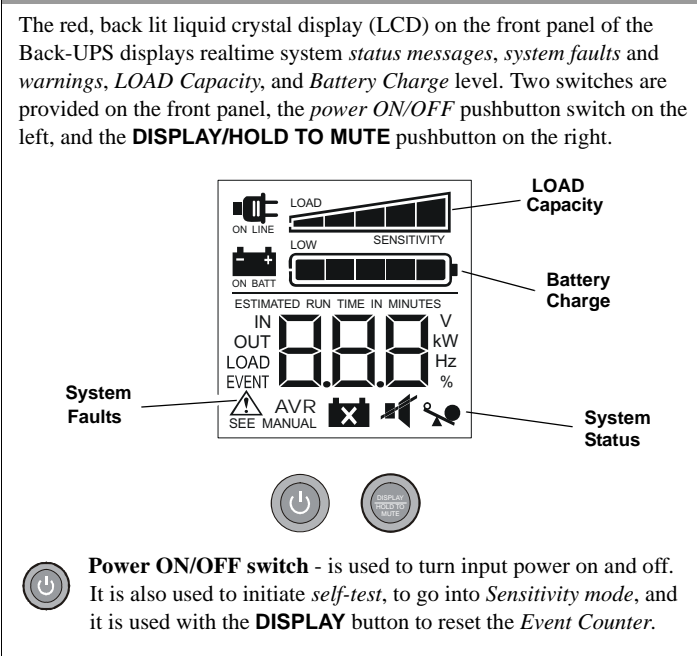

DISPLAY/HOLD TO MUTE button - is used to display status messages, system faults and warnings, and to perform various operations, such as alarm *mute mode*, *AVR* (automatic voltage regulation), and *full time display mode*. The various messages, warnings, system faults, and operations are described in greater detail on Page 2.

ON LINE - is lit whenever utility power is supplied to power the equipment connected to the Back-UPS.

ON BATT - the On Battery symbol is lit whenever battery backup power is used to power equipment connected to the Back-UPS.

Four Beeps Every 30 Seconds - this alarm sounds whenever the Back-UPS is running on battery (**ON BATT**). You should consider saving any work in progress.

Continuous Beeping - this alarm sounds whenever a low battery condition occurs, and battery run-time is very low. Promptly save any work in progress, exit all open applications, and shut down the operating system, computer,

Load Capacity - this indicator consists of a bar containing five blocks. When only one or two of the blocks are filled (lit), the unit **LOAD** is at less than half capacity.

However, when all five blocks are filled, the **LOAD** is at full capacity. If the **LOAD** exceeds the unit's rated capacity, the **Overload** symbol on the bottom of the display will flash off and on.

Battery Charge - this indicator consists of a bar with five blocks. When all five blocks are filled, the battery is fully charged. When only one block is filled (lit) the battery charge is low. The word **LOW** and the Battery Capacity indicator bar both flash off and on.

Overload - is lit whenever power demand exceeds the capacity of the Back-UPS. It is displayed in both **ON LINE** mode, and **ON BATT** mode.

Continuous tone - this alarm sounds whenever the battery backup outputs are overloaded. Overload mode is covered in greater detail on Page 2.

Replace battery - this is lit whenever the battery is near the end of its useful life, or if the battery is not connected. A battery nearing the end of its life should be replaced.

Chirps for 1 Minute every 5 hours - this alarm sounds whenever the battery fails the automatic diagnostic test.

AVR When lit, it indicates automatic voltage regulation (AVR) is in "Boost mode". **AVR** is covered in greater detail on Page 2.

System Faults - when a fault occurs, this symbol and the fault number (F01 - F09) will flash off and on. The nine fault messages are described further on Page 2.

Self-Test mode - can be run at any time when in **ON LINE** mode. Self-test is covered in greater detail on Page 2.

Mute mode - the audible alarm (beeper) can be muted (turned off), which is indicated by a line through the beeper symbol. Mute mode is covered in greater detail on Page 2.

Sensitivity mode - this allows you to go into sensitivity programming mode, and using the **DISPLAY** button you can select the **LO**, **MID** or **HIGH** sensitivity range. Sensitivity mode is covered in greater detail on Page 2.

Full Time Display mode - this mode allows you to set the LCD to full time display mode using the **DISPLAY** button. This mode is covered in greater detail on Page 2.

Reset switch - this switch is located on the rear of the Back-UPS, just above the fans, as shown in the figure in Step 4.

ON-LINE MODE Display Selection

When you are in ON-LINE mode, and press the DISPLAY button, you will rotate through the following seven groups of displays and messages.

When you press the DISPLAY button the *first time*, the LCD is back lit, and the input voltage (IN) *default screen* is displayed, in this example 110 V is displayed.

When you press the DISPLAY button a *second time*, the power EVENT counter is displayed, as shown below.

To reset the counter, press and hold the DISPLAY button, and press the power ON/OFF button.

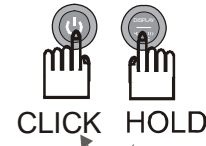
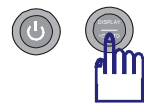
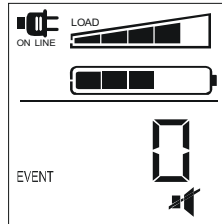
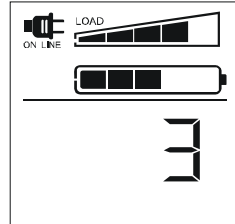
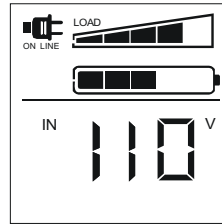

When you press the DISPLAY button the *third time*, the ESTIMATED RUN TIME IN MINUTES is displayed. In this example, the value is 18 minutes.

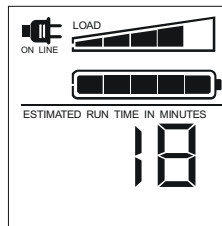

When you press the DISPLAY button a *fourth time* in ON LINE mode, the LOAD in Watts (W) is displayed, in this example 760 W is displayed.

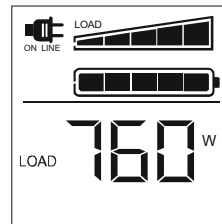

When you press the DISPLAY button a *fifth time*, the online LOAD as a percentage (%) is displayed, in this example it is 82%.

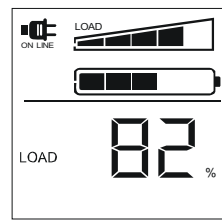

Pressing the DISPLAY button a *sixth time* displays the ON LINE output (OUT) voltage, in this example the value is 110 V.

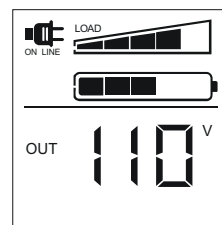

ON-LINE MODE (Continued)

When you press the DISPLAY button a *seventh time* the ON BATT output (OUT) frequency is displayed, in this example it is 60.0 Hz.

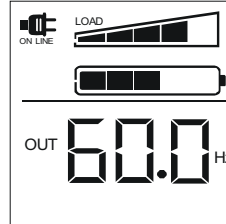

BATTERY MODE Display Selection

When you are in battery (ON BATT) mode, and press the DISPLAY button, you will rotate through the following seven groups of displays and messages.

When you press the DISPLAY button the *first time*, the LCD is back lit, and the default screen (ESTIMATED RUN TIME IN MINUTES) is displayed, in this case it is 18 minutes.

When you press the DISPLAY button a *second time*, the power EVENT counter is displayed, as shown below. To reset the counter, press and hold the DISPLAY button, and press the power ON/OFF button.

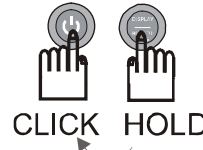
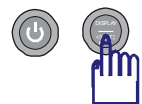
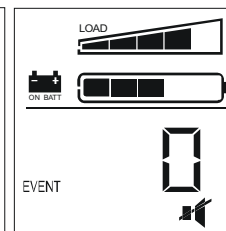
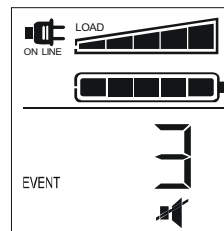
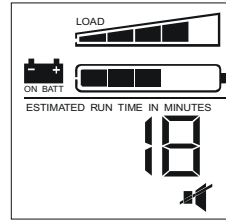

When you press the DISPLAY button a *third time* the battery backup (ON BATT) output (OUT) voltage (V) is displayed, in this example it is 115 V.

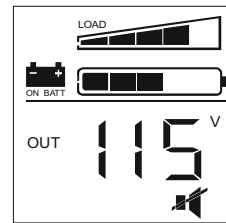

When you press the DISPLAY button a *fourth time* the battery backup (ON BATT) input voltage (IN) is displayed.

The first example shows an *over voltage* condition at 149 V. The second example shows a *black out*, or less than 10 Vac.

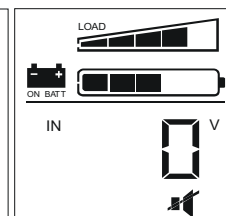
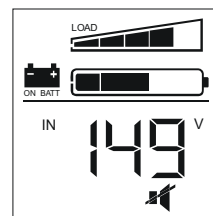

When you press the DISPLAY button a *fifth time* the (ON BATT) input LOAD in Watts (W) is displayed, in this example 760 W is displayed.

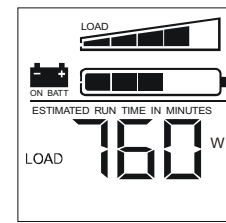

BATTERY MODE (Continued)

When you press the DISPLAY button a *sixth time*, the battery backup LOAD is displayed as a percentage (%); in this example it is 82%.

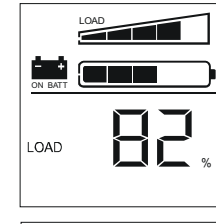

When you press the DISPLAY button a *seventh time* the ONLINE output (OUT) frequency is displayed, in this example it is 60.0 Hz.

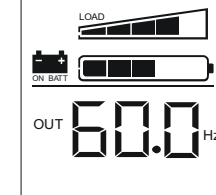

WARNINGS

Warning 1 - Online Overload

This warning indicates that there is an ONLINE overload condition at 1.25 kW, indicated by the flashing overload icon.

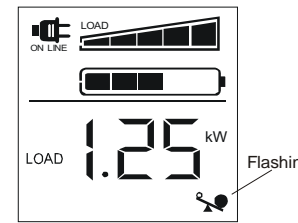

Warning 2 - Battery Backup Overload

This warning indicates that there is a backup battery (ONBATT) overload condition. This is indicated by the flashing overload icon.

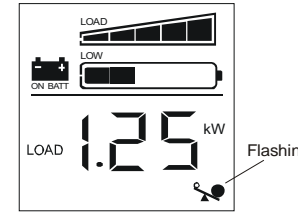

Warning 3 - Online Bad Battery

This warning indicates that you are in ONLINE mode, and you have a bad battery, indicated by the flashing bad battery icon.

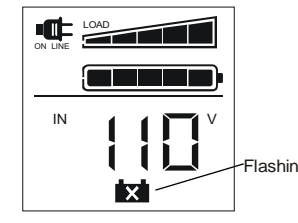

Warning 4 - Battery Backup Low Battery

This warning indicates that the battery is low. This is indicated by the word LOW, and the Battery Capacity indicator bar flashing.

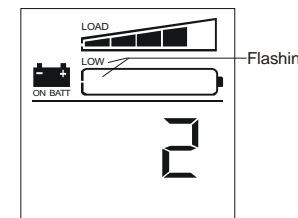

SYSTEM FAULTS

Up to nine system faults can be displayed (F01 - F09). A note, SEE MANUAL, is provided just below the system fault number. The system faults include:

- | | |
|--------------------------------|----------------------|
| F01 - On-Battery Overload | F06 - Relay Welding |
| F02 - On-Battery Output Short | F07 - Temperature |
| F03 - On-Battery XCap Overload | F08 - Fan Fault |
| F04 - Clamp Short | F09 - Internal Fault |
| F05 - Charger Fault | |

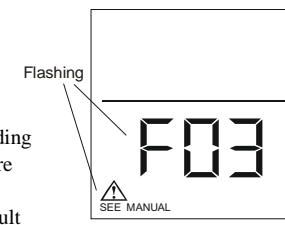

OTHER STATUS INDICATORS

Self-Test

To initiate self-test mode, press the power ON/OFF button, and hold it in for **ONE** second. The AC plug symbol (ON LINE) flashes off and on during self-test mode.

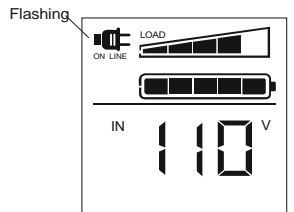

Mute

This feature allows you to mute the audible alarm (the beeper) for a *single display and message*. To mute the audible alarm, the unit should be *on battery*, or the "speaker" symbol is displayed. Press the DISPLAY/HOLD TO MUTE button for **ONE** second, the alarm (beeper) is toggled, and the "speaker-NOT" symbol (speaker with a line drawn through it) is displayed on the screen.

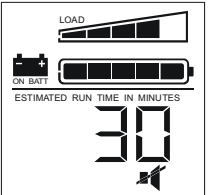

To enable an audible alarm that has been muted, perform the same steps that were used for muting the alarm.

The alarm (beeper) can also be muted all the time. With the speaker or speaker-NOT icon displayed, press and hold the DISPLAY/HOLD TO MUTE button for **FIVE** seconds until the speaker-NOT icon flashes off and on. The unit will mute the alarm all the time except for faults.

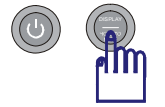

AVR

When AVR is illuminated on the LCD, it indicates that the automatic voltage regulation (AVR) circuitry is in *Boost mode*. AVR compensates for excessively low voltage conditions without going on battery. In this example, 90 V is displayed.

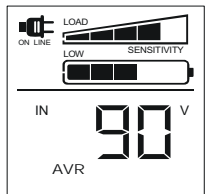

Sensitivity

A typical condition where sensitivity adjustments would be appropriate is with an AC line input, and with the UPS off.

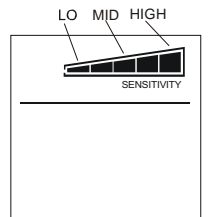

Press and hold the power ON/OFF pushbutton in for 10 seconds. The unit will go into "sensitivity programming mode". Use the ON/OFF button to select the LO, MID or HIGH range. LO displays one block, MID is three blocks, and High is five blocks. Sensitivity programming mode is also discussed on Page 3.

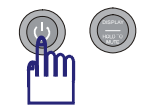

LCD Full Time Display Mode

The LCD can be set to *full time* display mode by performing the following steps:

1. Ensure the unit is connected to utility input power, and the power on/off switch is turned off (no power is supplied to the output connectors).
2. Press the DISPLAY/HOLD TO MUTE pushbutton, and hold it in for 10 seconds. All five blocks in the Battery Capacity bar will flash off and on, which indicates the unit is in *pushbutton programming mode*.

Note: A rotating selection method is used that allows you to step through the display modes using the DISPLAY/HOLD TO MUTE button until you select the display mode you want. For example, in *Power Save mode* none of the blocks are lit. If all five of the blocks are lit, it indicates the LCD is in *full time mode*, and will remain on full time.

3. When you rotate through the selections and reach the display mode you want, press and release the DISPLAY/HOLD TO MUTE button to select the display mode.

Note: If no buttons are pushed, and no operations occur for five seconds, the unit automatically exits pushbutton programming mode.

4. Once you have selected the desired display mode, continue with normal operations.

TROUBLESHOOTING

Problem	Possible Cause	Corrective Action
Back-UPS will not switch on.	Back-UPS is not connected to the AC power source.	Ensure the Back-UPS is securely connected to an AC outlet.
	Back-UPS circuit breaker "tripped".	Disconnect non-essential equipment from the Back-UPS. Reset the circuit breaker. Switch on the Back-UPS, and plug in devices one at a time. If the circuit breaker trips again, disconnect the device that caused the breaker to trip.
	Internal battery is not connected.	Connect the battery cartridge (see <i>Connect Battery Cartridge</i>).
	Utility input voltage quality is out of range.	Consider adjusting the transfer voltage and sensitivity. See <i>Transfer Voltage and Sensitivity Adjustment</i> .
Back-UPS does not power essential equipment during an outage.	Equipment is plugged into a Surge Only outlet.	Unplug the device from the 'Surge Only' outlet, and move to a 'Battery Backup' outlet.
Back-UPS operates on battery although utility power is provided.	The UPS's plug has partially pulled out of the wall outlet, the wall outlet was turned off, or its circuit breaker tripped.	Verify the Back-UPS's plug is fully inserted into the wall, and power is present at the wall outlet by plugging in a known good device.
	Unit is performing an automatic self test.	No action is necessary.
	Utility input voltage is out of range, frequency is out of range, or the waveform is distorted.	Consider adjusting the transfer voltage and sensitivity. Reference <i>Transfer Voltage and Sensitivity Adjustment</i> .
Back-UPS does not provide expected amount of backup time.	Back-UPS is overloaded.	Unplug non-essential equipment (printers, scanners, etc) from the Battery Backup outlets, and plug them into 'Surge Only' outlets.
	Back-UPS battery cartridge discharged due to a recent power outage, and has not had time to recharge.	Charge the battery cartridge for 16 hours. Back-UPS runtime is reduced until the battery cartridge is fully charged.
	Battery has reached end of life.	Refer to <i>Replace Battery Cartridge</i> , and replace the battery cartridge.
Replace Battery indicator is on.	Battery has reached end of life.	Refer to <i>Replace Battery Cartridge</i> , and replace the battery cartridge.
Overload indicator is on, or flashing.	Connected equipment is drawing more power than the Back-UPS can provide.	Move one or more equipment power plugs from Battery Backup outlets to Surge Only outlets.
System Fault indicator is on and all other front panel indicators are flashing.	Internal UPS fault.	One of nine Internal UPS Fault Messages is displayed: F01 - On-Battery Overload F06 - Relay Welding F02 - On-Battery Output Short F07 - Temperature F03 - On-Battery XCap Overload F08 - Fan Fault F04 - Clamp Short F09 - Internal Fault F05 - Charger Fault Contact APC Technical Support (see <i>Contact Information</i>).

TRANSFER VOLTAGE and SENSITIVITY ADJUSTMENT

In situations where the Back-UPS or connected equipment appears too sensitive to the input voltage, it may be necessary to adjust the transfer voltage. This is a simple task using the front panel power on/off pushbutton. To adjust the transfer voltage, proceed as follows:

1. Plug the Back-UPS into the utility power source, but do not turn the unit on. The Back-UPS will be in *standby mode* (there are no indicators lit).
2. Press and hold the front panel on/off switch in for 10 seconds, until all the indicators on the Back-UPS flash to acknowledge it has entered *sensitivity programming mode*. Release the on/off button, the blocks in the Back-UPS's LOAD bar shown on the LCD indicate it's current sensitivity setting, as described in the table below.

Note: The Back-UPS automatically exits programming mode in five seconds if no buttons are pressed, and no operations are run.

Reference the table below to determine which sensitivity setting to select.

Indicators Flashing	Sensitivity Setting	Input Voltage Range (utility operation)	Use When
1 (one block of the Load Bar)	Low	78 to 142 Vac	Input voltage is extremely low or extremely high. Not recommended for computer loads.
2 (three blocks of the Load Bar)	Medium (factory default)	88 to 139 Vac	The Back-UPS frequently goes on battery (ON BATT).
3 (five blocks of the Load Bar)	High	88 to 136 Vac	The connected equipment is sensitive to voltage fluctuations.

4. To select the *Low Sensitivity* setting, press and release the ON/OFF switch several times until only the *first block* in the Load Bar is lit and flashing, then release the switch.
5. To select the *Medium Sensitivity* setting (the unit's default), press and release the ON/OFF switch until the first *three blocks* in the Load Bar are lit and flashing, then release the switch.
6. To select the *High Sensitivity* setting, press and release the ON/OFF switch until all *five blocks* of the Load Bar are lit and flashing, and then release the switch.
7. If there are no operations for five seconds, the Back-UPS will automatically exit sensitivity programming mode, and the Back-UPS is ready for normal operation.

SPECIFICATIONS

Item	1300 VA / 1500 VA
On-line Input Voltage Range (default settings)	88 to 139 VAC
Automatic Voltage Regulation (AVR)	+12% (Boost mode only)
On-line Frequency Range	57 to 63 Hz (Autosensing)
On-battery Waveshape	Stepped Sine Wave
Maximum Load	1300 VA: 780 W 1500 VA: 865 W
Typical Recharge Time	1300 VA: 16 Hours and 1500 VA: 16 Hours
Operating Temperature	32° to 104°F 0° to 40°C
Storage Temperature	23° to 113°F -5° to 45°C
Operating / Storage Relative Humidity	0 to 95% non-condensing
Size (H x W x D)	8.7 inch x 5.1 inch x 13.8 inch 220 mm x 130 mm x 350 mm
Weight	1300 VA: 29.7 lbs (13.5 kg) 1500 VA: 30.7 lbs (14.0 kg)
Shipping Weight	1300 VA: 33.2 lbs (15.1 kg) 1500 VA: 34.2 lbs (15.6 kg)
EMI Classification	FCC / DOC Class B Certified
On Battery Run-Time	Go to: http://www.apc.com/product
Approvals	TUV C-US, NOM
Notice: This device complies with Parts 68 and 15 of the FCC rules. Operation is subject to the following two conditions: (1) This device may not cause harmful interference. (2) This device must accept any interference received, including interference that may cause undesired operation.	
There is a label on the bottom of this equipment that contains, among other information, the <i>FCC registration number</i> and <i>ringer equivalence number (REN)</i> for this equipment. If requested, this information must be provided to the telephone company.	

ORDER REPLACEMENT BATTERY

The battery cartridge typically lasts 3 to 6 years, a shorter period if subjected to frequent outages or elevated temperatures. For the BR1300LCD, BR1500LCD, BX1300LCD and BX1500LCD order part **APCRBC109**. Please recycle spent battery cartridges.



WARRANTY

The standard warranty is three (3) years from the date of purchase. APC's standard procedure is to replace the original unit with a factory reconditioned unit. Customers who must have the original unit back due to the assignment of asset tags and set depreciation schedules must declare such a need at first contact with an APC Technical Support representative. APC will ship the replacement unit once the defective unit has been received by the repair department, or cross-ship upon the receipt of a valid credit card number. The customer pays for shipping the unit to APC. APC pays ground freight transportation costs to ship the replacement unit to the customer.

SERVICE

If the Back-UPS arrived damaged, notify the carrier.

If the Back-UPS requires service, do not return it to the dealer. The following steps should be taken:

1. Consult the Troubleshooting section to eliminate common problems.
2. If the problem persists, go to <http://www.apc.com/support/>.
3. If the problem still persists, contact APC Technical Support.
 - Have the Back-UPS model number, serial number and date of purchase available. Be prepared to troubleshoot the problem with an APC Technical Support representative. If this is not successful, APC will issue a Return Merchandise Authorization (RMA) number and a shipping address.

CONTACT INFORMATION

Technical Support	http://www.apc.com/support
Internet	http://www.apc.com
USA / Canada	1.800.800.4272
Mexico	292.0253 / 292.0255
Worldwide	+1.401.789.5735



Artisan Technology Group is your source for quality new and certified-used/pre-owned equipment

- FAST SHIPPING AND DELIVERY
- TENS OF THOUSANDS OF IN-STOCK ITEMS
- EQUIPMENT DEMOS
- HUNDREDS OF MANUFACTURERS SUPPORTED
- LEASING/MONTHLY RENTALS
- ITAR CERTIFIED SECURE ASSET SOLUTIONS

SERVICE CENTER REPAIRS

Experienced engineers and technicians on staff at our full-service, in-house repair center

*InstraView*SM REMOTE INSPECTION

Remotely inspect equipment before purchasing with our interactive website at www.instraview.com ↗

WE BUY USED EQUIPMENT

Sell your excess, underutilized, and idle used equipment. We also offer credit for buy-backs and trade-ins. www.artisanng.com/WeBuyEquipment ↗

LOOKING FOR MORE INFORMATION?

Visit us on the web at www.artisanng.com ↗ for more information on price quotations, drivers, technical specifications, manuals, and documentation

Contact us: (888) 88-SOURCE | sales@artisanng.com | www.artisanng.com