



Artisan Technology Group is your source for quality new and certified-used/pre-owned equipment

- FAST SHIPPING AND DELIVERY
- TENS OF THOUSANDS OF IN-STOCK ITEMS
- EQUIPMENT DEMOS
- HUNDREDS OF MANUFACTURERS SUPPORTED
- LEASING/MONTHLY RENTALS
- ITAR CERTIFIED SECURE ASSET SOLUTIONS

SERVICE CENTER REPAIRS

Experienced engineers and technicians on staff at our full-service, in-house repair center

*InstraView*SM REMOTE INSPECTION

Remotely inspect equipment before purchasing with our interactive website at www.instraview.com ↗

WE BUY USED EQUIPMENT

Sell your excess, underutilized, and idle used equipment. We also offer credit for buy-backs and trade-ins. www.artisanng.com/WeBuyEquipment ↗

LOOKING FOR MORE INFORMATION?

Visit us on the web at www.artisanng.com ↗ for more information on price quotations, drivers, technical specifications, manuals, and documentation

Contact us: (888) 88-SOURCE | sales@artisanng.com | www.artisanng.com

HORIZON Nxt®

Operation Manual

©1999 B.Braun Medical Inc.

This manual may not, in whole or in part, be copied, photocopied, reproduced, translated, or converted to any electronic or machine-readable form without prior written consent of B.Braun Medical Inc.

Table of Contents

Chapter 1 INTRODUCTION.....	1-1
Warranty	1-1
Intended Use	1-2
Epidural Administration	1-2
Blood Infusion	1-3
$q(x)^o$	1-3
Chapter 2 PRODUCT DESCRIPTION	2-1
Operating Modes.....	2-1
Operating States	2-1
Illustrations	2-2
Important Keys	2-4
Daisy Chaining	2-4
Battery Operation.....	2-4
Chapter 3 PRINCIPLES OF OPERATION.....	3-1
Cassette Removal.....	3-1
Standard Mode	3-2
For Primary Fluids	3-2
For Piggyback Fluids	3-2
Piggyback Callback	3-3
Changing the Rate.....	3-3
During Infusion (titration)	3-3
With Pump on Hold	3-4
Chapter 4 MENUS	4-1
Main Menu	4-1
Alternate Menu	4-1
Change Alarm Volume	4-2
Clear Total Infused	4-2
Dose Mode	4-2
Occlusion Limit	4-3
Alternate Menu Items	4-4
Calculate BSA	4-4
Set LCD Contrast.....	4-4
Chapter 5 CUSTOM MENU OPTIONS	5-1
Check Battery Level	5-2
Hold Extender	5-3
Micro Rate / Limit	5-3
Monitor Docking.....	5-4
Occlusion Warning	5-1
Piggyback Callback	5-5
PROFILE Mode	5-5
PROGRAM Mode	5-5
$q(x)^o$ Schedule.....	5-5
Schedule Next Run	5-9
Select MAX Pressure	5-10
Set PROFILE Parameters	5-11

Set Time and Volume	5-11
Site Trend.....	5-12
Exit from Menu.....	5-12
Chapter 6 DOSE MODE	6-1
Drug Menus	6-1
Epidural Category	6-2
Concentration Screen	6-2
Data Screen	6-2
Change SetUp Parameters	6-3
Titrate Rate	6-4
Titrate Dose	6-4
Exit DOSE Mode	6-4
Chapter 7 SPECIAL MODES.....	7-1
Profile Mode	7-1
Change Profile Parameters:	7-1
Data Entry	7-1
Review/Change PROFILE Data	7-2
Restart PROFILE	7-2
Immediate Ramp Down	7-2
Exit PROFILE Mode	7-3
Program Mode	7-4
Data Entry	7-4
Review/Change PROGRAM	7-5
Restart PROGRAM	7-6
Skip PROGRAM Periods	7-6
Exit PROGRAM Mode	7-6
Chapter 8 MAINTENANCE	8-1
Cleaning	8-1
Alarm Procedures	8-2
Alarm Troubleshooting Guide	8-3
Cautions	8-5
Service and Performance Information	8-7
Specifications	8-8
Chapter 9 Table 1 DRUG LIST.....	9-1
Index	Index-1

Chapter 1 INTRODUCTION

Warranty

B. Braun Medical Inc., hereby warrants that reasonable care has been used in the manufacture of each Horizon Nxt® and that it shall be free from defects in material and workmanship for a period of two years after the date of shipment, when properly used and maintained. Any Horizon Nxt® that is found not to meet these standards within this two-year period will be repaired after examination by B. Braun Medical or, at B. Braun Medical's option, will be replaced without charge. If the defect has been caused by misuse, unauthorized modification, or abnormal conditions or operation, repairs will be billed at B. Braun Medical's then current charges. In this case, an estimate will be submitted before work is started, if requested. The defective device should be returned promptly to B. Braun Medical, properly packaged, postage prepaid. Loss or damage in return shipment to B. Braun Medical will be at purchaser's risk. The foregoing express warranty, as conditioned and limited, is in lieu of and excludes all other warranties not expressly set forth herein, whether expressed or implied by operation of law or otherwise including, but not limited to, any implied warranties of merchantability or fitness, since handling, storage, and cleaning of these devices, as well as factors relating to other matters beyond B. Braun Medical's control, directly affect these devices and the results obtained from their use. B. Braun Medical shall not be liable for any incidental or consequential loss, damage, or expense, directly or indirectly arising from the use of this device other than replacement of all or part of it. B. Braun Medical neither assumes, nor authorizes any other person to assume for it, another or additional liability or responsibility in connection with this device.

This warranty will not apply to any Horizon Nxt® or component thereof which has been: (1) repaired by anyone other than an authorized B. Braun Medical trained technician or repair facility; (2) altered in any way that, in B. Braun Medical's judgement, affects its stability or reliability; (3) subjected to misuse, negligent handling, or accident; (4) used in any manner not in accordance with the instructions furnished by B. Braun Medical in the Operation and/or Service Manual.

This warranty extends only to the first purchaser or lessee and does not extend to, and may not be enforced by, any other person.

Intended Use

The Horizon Nxt® is intended for use with B. Braun Medical Horizon® I.V. sets to regulate the flow of primary and secondary fluids when positive pressure is required. The infusion system is capable of delivering fluid from a negative head height (when the I.V. fluid container is lower than the pump), and provides clinically accepted volumetric accuracy for all standard I.V. fluids, including blood, lipids and TPN.

Positive pressure is frequently a necessity but clinical experience shows that high pressure limits can increase the severity of an infiltration without causing an alarm. Because there is a need to control pump pressure settings, the Horizon Nxt has user-selectable occlusion pressure limit settings which start at 75 mmHg and extend to 500 mmHg. At rates of 400 mL/hr and higher, the pressure setting is automatically increased to 400 mmHg. For epidural infusions which require higher pressures, the pump has an extended occlusion pressure setting of 750 mmHg.

Because some infusions require multiple flow rates during the delivery cycle, the Horizon Nxt is equipped with two automatic multiple delivery rate modes. The Profile Delivery mode incorporates a standard ramped delivery regimen, and the Programmable Delivery mode can be set up to sequentially deliver up to nine user-selected volumes of fluid each at a user-selected rate. Both modes are designed for ease of use and can be adapted to home-care settings.

The Horizon Nxt also incorporates a Dose/Rate mode which automatically calculates the rate when dose information is entered, or the dose when rate information is entered.

The pump is equipped with distinct audible and visual alarm signals to indicate KVO, low battery, and actual alarm conditions.

Epidural Administration

The Horizon Nxt can be used for epidural administration of anesthetic and analgesic drugs.

Caution: Whenever the pump is being used for epidural infusions, the pump's secondary infusion features should not be used.

For epidural administration of anesthetic drugs, use indwelling catheters specifically indicated for short-term (96 hours or less) anesthetic epidural drug delivery.

For epidural administration of analgesic drugs, use indwelling catheters specifically indicated for either short-term or long-term analgesic epidural drug delivery.

When the Horizon Nxt® is being used for epidural infusions, the source container and administration set should be clearly differentiated from source containers and administration sets used for other routes of infusion.

Caution: To prevent inadvertent infusion of drugs which are not indicated for epidural use, only Horizon microbore administration sets, without injection sites, that are specified for epidural administration of drugs should be used.

Following an occlusion alarm, a small amount of fluid may be delivered. Use of a microbore set assures this is less than 0.1 mL.

The administration of drugs is restricted to those anesthetic and analgesic drugs labeled for continuous epidural administration.

Warning: Serious injury to the patient may result from epidural administration of drugs other than those specifically labeled for epidural use.

Blood Infusion

The Horizon Nxt can be used for infusion of blood and blood products. For blood infusion, a Horizon Pump Blood Set should be used. Do not attempt to piggyback blood. The normal saline roller clamp on the blood tubing set must be clamped off. The high viscosity of blood will cause the saline to infuse before the blood if both clamps are left open.

$q(x)^{\circ}$

The Horizon Nxt can be used for the periodic infusion of antibiotics, chemotherapy or other IV infusions according to a schedule set by the user. Assure that there is a maintenance IV infusing in the intervals between pump infusions.

Chapter 2 PRODUCT DESCRIPTION

The Horizon Nxt® has been developed in response to the special needs of all caregivers in the medical setting.

Operating Modes

The Horizon Nxt pump has five operating modes:

Standard Mode - for simple IV fluid delivery with piggyback capability.

Dose Mode - used for administration of medication where concentrations and doses are critical. The pump will automatically calculate either the dose or rate.

Profile Mode - offers a tapered delivery mode for infusing TPN or other fluids requiring ramp up and ramp down time.

Program Mode - offers maximum flexibility in customizing IV fluid administration. Up to 9 separate periods of fluid volume can be infused sequentially.

q(x)^o Mode - can be used for the periodic infusion of antibiotics, chemotherapy or other IV infusions according to a schedule set by the user. Assure that there is a maintenance IV infusing in the intervals between pump infusions.

Operating States

There are 4 operating states:

Hold - silences an alarm, stops an infusion, or is a quick escape from the menu.

Alarm - stops an infusion to notify the user of an error.

KVO - 3 mL/hr for delivery rates of 3 to 999.9 mL/hr, or the continuation of the delivery rate for 0.1 to 2.9 mL/hr settings.

Run - starts the infusion.

Illustrations:

Figure 1: Front View

1. Alarm Indicator	12. Hold Key
2. Run Indicator	13. Menu Key
3. Hold Indicator	14. Cursor Keys
4. Battery Use Indicator	15. Enter Key
5. AC Use Indicator	16. Piggyback Rate Display
6. Power Key	17. Piggyback Volume Display
7. Primary Indicator Key	18. Information Screen
8. Piggyback Indicator Key	19. Primary Rate Display
9. Primary Run Key	20. Primary Volume Display
10. Piggyback Run Key	21. Door Lever
11. Data Keys	

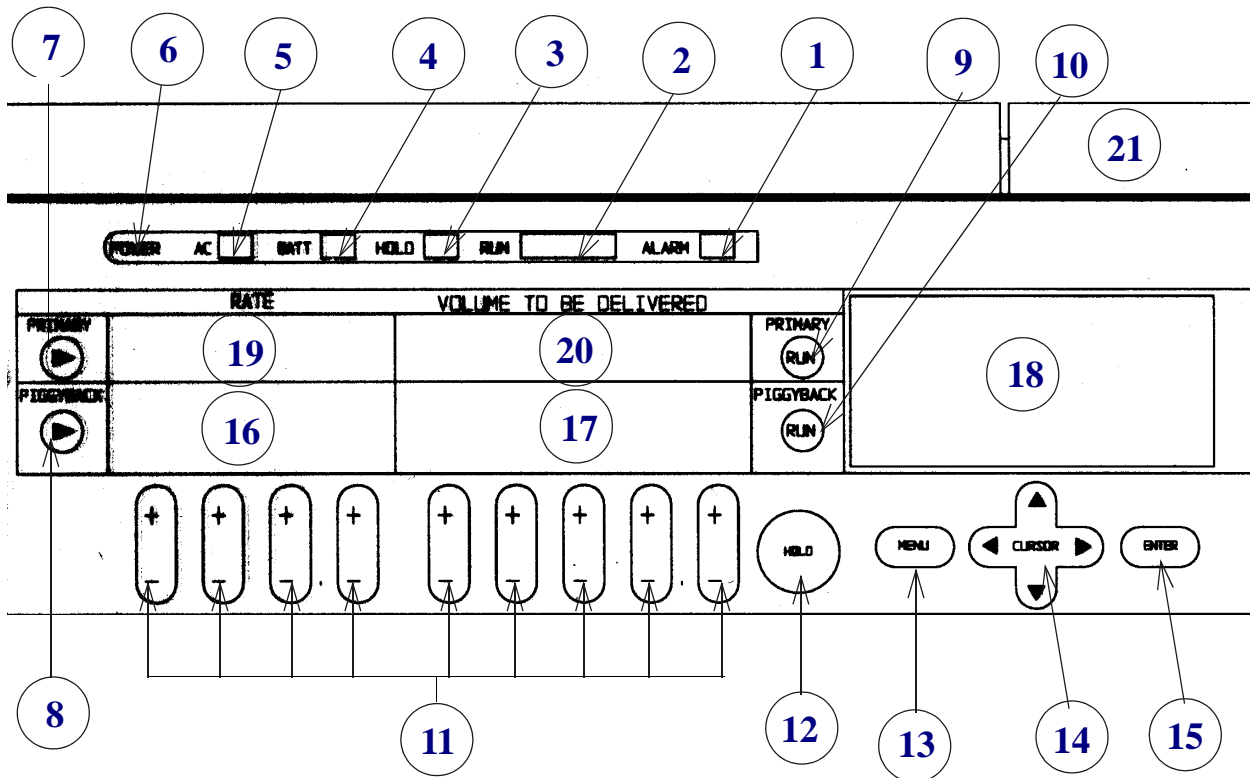

Figure 2: Rear View

1. Panel Lock Out Switch
2. Serial Communication Data Port

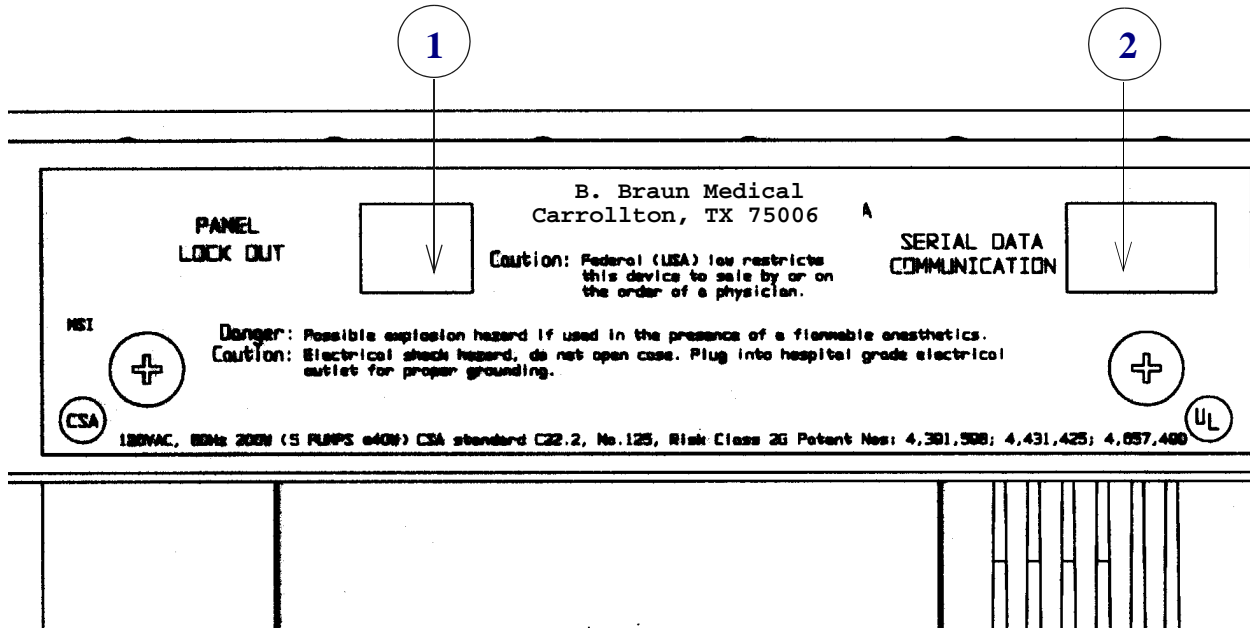
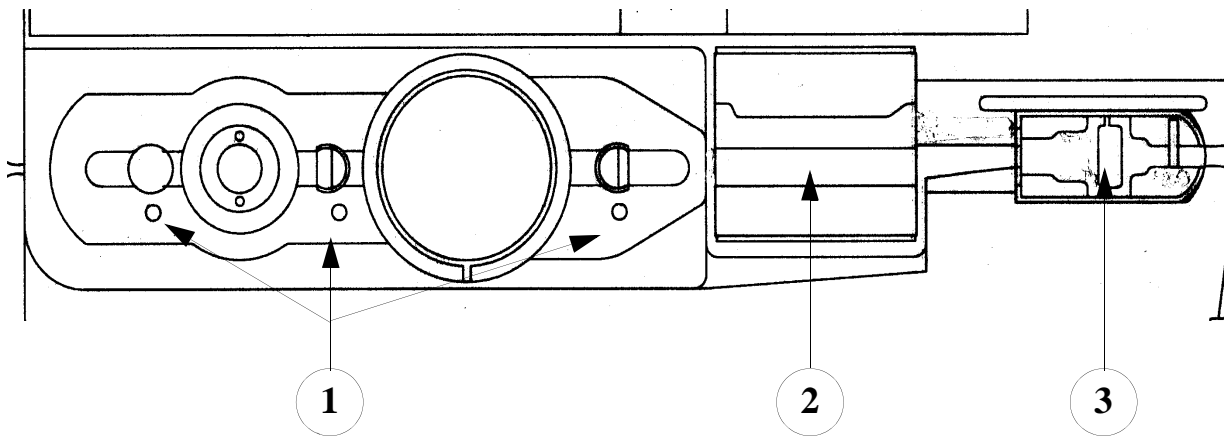

Figure 3: Inside the Door



1. Cassette Alignment Pins
2. Air-In-Line Detector
3. Free Flow Protection Clip

Important Keys

An understanding of the function and location of these keys will assist in the use of the pump.

From Figure 1:

- Power key (6) turns the pump on and off
- Data keys (11) allow input of data values
- Hold key (12) silences an alarm, stops an infusion, is a quick escape from the menu, and extends the Hold state an additional 3 minutes every time it is pushed if Hold Extender is active.
- Menu Key (13) lets the user see options using a menu screen
- Cursor keys (14) move the cursor bar on the Information Screen
- Enter key (15) validates or accepts the selection made

From Figure 2:

- Panel Lock Out Switch locks the keypad to prevent tampering. The switch can only be used while the pump is infusing.

Daisy Chaining

Daisy chaining allows up to 5 Horizon Nxt® or Horizon® pumps to be plugged into each other with only one pump plugged into a wall outlet. On the side of each Horizon Nxt pump is an electrical outlet. Only another Horizon or Horizon Nxt pump should be plugged into that outlet.

Caution: To daisy chain more than 5 pumps, verify that the total leakage current as a system does not exceed 100 uA.

Battery Operation

The Horizon Nxt has been equipped with an internal, rechargeable battery which will power the pump automatically if the plug is disconnected during use. Battery power is provided as a back-up system only, and the length of the battery life is affected by the rate of delivery. Whenever possible, the pump should remain plugged into an electrical outlet. The Battery Use indicator will be lit when the pump is operating on its battery.

The pump must remain plugged into a hospital-grade electrical outlet for at least 24 hours to fully recharge the battery from a totally discharged condition.

Chapter 3 PRINCIPLES OF OPERATION

Caution: Use only with B. Braun Medical Horizon® I.V. Sets

- 1) To attach the pump to the I.V. pole:
 - a) Press down on the pole clamp lever.
 - b) Position the pump on the pole (make sure the pole is up against the slot of the pump).
 - c) Release the pole clamp.
 - d) Lock by rotating the pole clamp lever 1/4 turn, toward the rear of the pump.
- 2) Plug the pump's power cord into a hospital-grade electrical outlet, or the AC Receptacle on the side of another Horizon or Horizon Nxt pump.
- 3) Press the Power key. If the Information Screen says:

"PROGRAM Operation Was Interrupted..." choose an option using the **CURSOR** keys. Press the **ENTER** key.

"PROFILE Operation Was Interrupted..." choose an option using the **CURSOR** keys. Press the **ENTER** key.
- 4) Open the door of the pump by pulling the Door Lever.
- 5) Prepare the IV fluids as described on the set package. Close the downstream roller clamp.
- 6) Position the cassette over the Cassette Alignment Pins, with the metal disc toward the pump. Thread the tubing through the Air-In-Line Detector. Insert and press the Free Flow Protector Clip into the receptacle.

Warning: Unrestricted fluid flow may occur if the Free Flow Protector Clip is not properly installed in the receptacle.

- 7) Close the door of the pump.
- 8) Open all clamps on the pump set.

Note: Do not use a pump with visible damage or with bent, damaged or missing components.

Cassette Removal

- 1) Press the **HOLD** key. Open the door of the pump.
- 2) Grasp the Free Flow Protector Clip and pull it from the Free Flow Protector receptacle while grasping the tubing as it enters the left side of the pump. Gently pull with both hands to remove the cassette from the pump. Grasping the Free Flow Protector Clip and removing it from the pump will automatically stop the flow of fluid in the tubing.
- 3) If gravity infusion is desired, close the roller clamp, open the Free Flow Protector Clip and adjust the flow with the roller clamp.

Standard Mode

For Primary Fluids:

- 1) Press the **PRIMARY INDICATOR** key.
- 2) Press the **DATA** keys to enter the rate and volume.
- 3) Press the **PRIMARY RUN** key to start the infusion.
- 4) Press the **PANEL LOCK OUT SWITCH** to make the key panel tamper proof, if desired.

The time left, total infused, and occlusion pressure limit are shown on the Information Screen. Monitor the infusion according to hospital policy. After the infusion is complete, the pump will alarm and go into the KVO state.

For Piggyback Fluids:

The Piggyback option can only be enabled by Biomedical personnel. The piggyback option is not available while operating the pump in the Dose Mode.

Caution: Do not attempt to infuse both fluids simultaneously using this method.

- 1) Prepare IV fluids according to the set package. Use primary sets with check valves.
- 2) Connect the piggyback set to the upper injection site (the site above the pump) on the primary set.
- 3) Lower the primary bag at least 8 inches.

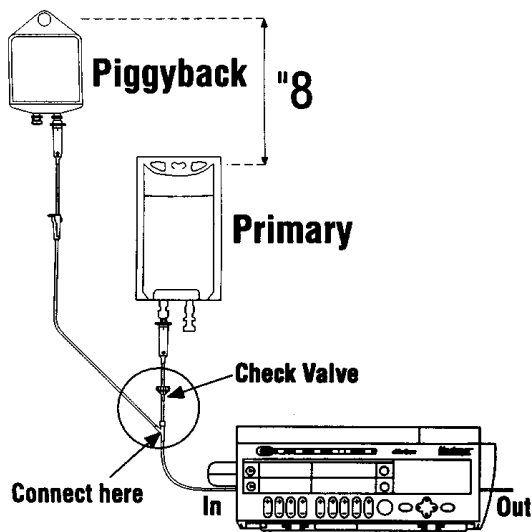

Note: To minimize or prevent fluid flow from the primary container during

a piggyback infusion (sympathetic flow), it may be necessary to lower the primary bag more than 8 inches or clamp off the primary tubing. Sympathetic flow increases significantly when the piggyback rate is greater than 125 ml/hr, and clamping the primary tubing is recommended at rates greater than 125 ml/hr.

- 4) Press the **PIGGYBACK INDICATOR** key.
- 5) Enter the Piggyback rate and volume.

Note: The programmed Piggyback volume to be infused must be equal to the amount of fluid in the Piggyback container to prevent incorrect delivery. Automatic piggyback is not intended for the infusion of fluids requiring flushing before and after administration because of incompatibility.

- 6) Press the **PIGGYBACK RUN** key.

When the Piggyback volume is complete, the Piggyback Rate and Volume Displays will blank. The Primary Rate and Volume Displays will light up. The infusion will now be delivered at the primary rate. Make sure the primary tubing is not clamped.

Note: If the secondary container is not empty, the remaining secondary fluid will be delivered at the primary flow rate.

Piggyback Callback

This feature causes the pump to alarm and continue the infusion at a KVO rate after the programmed piggyback volume is infused. Piggyback Callback must be selected in the User menu.

Changing the Rate

During Infusion (titration):

- 1) Press the **DATA** keys to change the rate.
- 2) Press the **ENTER** key or the **PRIMARY RUN** key to validate data.

Note: If the **ENTER** key or **RUN** key is not pressed within 4 seconds of entering a new rate, a series of error beeps will occur and the rate change will be cancelled. The pump will then display the message "Rate change aborted", and will continue to infuse at the old rate. An intermittent alarm will continue to sound to notify the user that a rate change has been attempted and cancelled. Pressing any key will silence the alarm.

With Pump on Hold:

- 1) Press the **HOLD** key.
- 2) Press the **DATA** keys to change the rate.
- 3) Press the **RUN** key to start the infusion.

Chapter 4 MENUS

The Horizon Nxt® can be customized to fit your specific needs. The User Menu and Alternate Menu contain options identified by each individual hospital. The following options will always appear in one of the 2 menus.

Main Menu

Change Alarm Volume changes the volume of the audible alarm.

Clear Total Infused clears the total IV fluid infused shown on the Information Screen.

Dose Mode calculates the rate or dose information necessary for use with many critical drug infusions.

Occlusion Limit sets the occlusion pressure limit to 75, 100, 200, 300, 400 or 500 mmHg.

Alternate Menu lists options used less often by the user.

Exit from Menu returns to the Information Screen.

Alternate Menu

Calculate BSA calculates the body surface area (BSA).

Set LCD Contrast changes the readability of the Information Screen.

Biomed Options allows access to the Biomed Menu.

Exit from Menu returns to the Information Screen.

Change Alarm Volume:

The volume of the alarm can be changed to low, medium or high.

- 1) Press **MENU** key
- 2) Press **CURSOR** keys to select Change Alarm Volume
- 3) Press **ENTER** key

- 1) Press **CURSOR** keys to change the intensity of the alarm
- 2) Press **ENTER** key

Change Alarm Volume
Low Medium High
Move Cursor & Press ENTER

The pump will return to the previous Hold or Run state.

Clear Total Infused

This feature clears the Total Volume displayed on the Information Screen.

Note: The volume can be cleared while the pump is running.

- 1) Press **MENU** key
- 2) Clear Total Infused is already selected
- 3) Press **ENTER** key.

- 1) Press **ENTER** key.
- 2) The total volume displayed on the Information Screen goes to zero.

The present Total Infused of 125.02 ml will be zeroed. Is this OK? Yes No
Cursor & Press ENTER

The pump will return to the previous Hold or Run state.

Dose Mode:

The Dose Mode is fully described in the Dose Mode Chapter.

Occlusion Limit

This feature lets the user change the occlusion pressure limit to 75, 100, 200, 300, 400, or 500 mmHg. At rates of 400 mL/hr and higher, the pressure setting is automatically increased to 400 mmHg. Occlusion pressure is a threshold value.

For Example: If the occlusion pressure is set to 300 mmHg, the pump will infuse at the lowest pressure possible but will alarm if the pressure required to infuse the IV fluid rises above the 300 mmHg value.

A gravity infusion of D5W with the IV container 3 feet above the IV site is equivalent to approximately 70 mmHg.

The occlusion warning feature is optional. The occlusion warning feature gives an audible warning (3 beeps) and a visual indication in the LED display to let the user know an occlusion is occurring downstream from the pump. This warning occurs 5 times at 5-second intervals before alarming "Occlusion." This feature is designed to alert the clinician of downstream resistance before an alarm occurs which stops the infusion.

Caution: The higher the pressure limit, the less sensitive the pump is to changes in fluid resistance which may be caused by positional IV's or infiltrations. High pressure limits can increase the severity of an infiltration without an alarm condition.

Note: To select a pressure of 750 mmHg, refer to Select MAX Pressure.

- 1) Press **MENU** key
- 2) Press **CURSOR** keys to select Occlusion Limit
- 3) Press **ENTER** key
- 4) Press **DATA** keys to change the pressure limit
- 5) Press **ENTER** key

The pump will return to the previous Hold state.

Alternate Menu Items:

Calculate BSA:

Use this feature to calculate body surface area (BSA).

- 1) Press **MENU** key
- 2) Press **CURSOR** keys to select Calculate BSA
- 3) Press **ENTER** key

Note: Height can be measured in centimeters (cm) or inches (in). Weight can be measured in grams (g), kilograms (kg) or pounds (lb). The height and weight parameters are changed by pressing the Cursor to select the parameter and pressing the up or down Cursor key.

- 1) Press **CURSOR** keys to select “Ht” and “Wt” values
- 2) Press the **DATA** keys to enter the information
- 3) The BSA value is displayed
- 4) Press **ENTER** to exit

Calculate BSA
Ht = 100 cm Wt = 70 kg
BSA = 1.23 m ²
Press ENTER when done

Set LCD Contrast:

This option allows the user to change the readability of the Information Screen.

- 1) Press **MENU** key
- 2) Press **CURSOR** keys to select Set LCD Contrast
- 3) Press **ENTER** key

- 1) Press right and left **CURSOR** keys to vary the contrast
- 2) Press **ENTER** key to validate

EXIT
Adjust cursor $\leftarrow \rightarrow$ until this message is clear. Then press ENTER key.

The pump will return to the previous Hold or Run state.

Chapter 5 CUSTOM MENU OPTIONS

The following items can be added to either the User or Alternate Menus by the Biomedical Department. The Custom Menu items are listed in alphabetical order.

Check Battery Level graphically displays the state of the charge of the battery.

Hold Extender lengthens the hold time to a maximum of 120 minutes. This option must be turned on by the Biomedical Department.

Micro Rate / Limit limits the infusion rate. (Useful for Pediatric and Neonatal settings).

Monitor Docking allows the Horizon Nxt® with MedScan to communicate with select monitoring systems to visually display current infusion parameters. This option must be turned on by the Biomedical Department.

Occlusion Warning is designed to alert the clinician of downstream resistance. An audible warning (three beeps) and a visual indication will occur 5 times at 5-second intervals before alarming "Occlusion." This option must be turned on by the Biomedical Department.

Piggyback Callback continues the primary infusion at a KVO rate and alarms once the piggyback is complete.

PROFILE Mode incorporates a ramped delivery regimen based on the patient's specific needs.

PROGRAM Mode lets the user program a maximum of nine selected volumes of fluid.

q(x)° Schedule allows the programming of periodic IV infusions.

Schedule Next Run delays the start of an infusion for up to 24 hours.

Select MAX Pressure sets the occlusion pressure limit to the maximum value of 750 mmHg.

Set PROFILE Parameters alters the ramping process.

Set Time and Volume allows the delivery rate to be calculated based on time. (for example: 1000 ml to be infused over 8 hours)

Site Trend graphically displays the resistance to downstream fluid flow. A Resistance Factor can be enabled by the Biomedical Technician which will display a numerical value both on the Run/Hold screen and when Site Trend graph is displayed.

Each of the above options are described more fully in this chapter. The options are listed in alphabetical order.

Check Battery Level:

Three states of the battery are possible: discharging, charging or fully charged. Prior to unplugging the pump for transport purposes, this feature makes it easy to determine the state of the battery.

- 1) Press **MENU** key
- 2) Press **CURSOR** key to select Alternate Menu
- 3) Press the **MENU** key
- 4) Press **CURSOR** key to select Check Battery Level
- 5) Press **ENTER** key

One of the three graphs below will be displayed:

Discharging:

The pump is unplugged or running on battery.

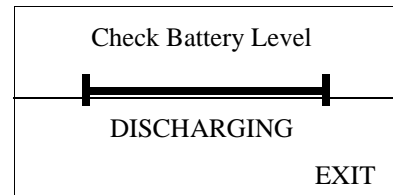

Charging:

The pump is not fully charged.

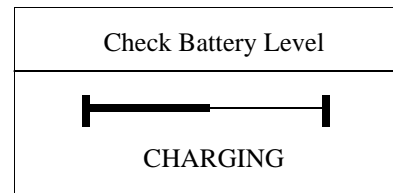

Fully Charged:

The pump is 95% or more charged.

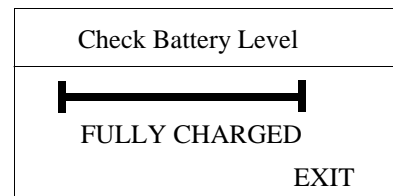

Press the **ENTER** key to return to the Hold or Run state.

Hold Extender

The normal Hold Time is 3 minutes. Use this option to extend that time to a maximum of 120 minutes.

- 1) Press **HOLD** key to add time in 3 minute increments, or
- 2) Press **CURSOR** keys to select the hours or minutes and use **DATA** keys to change the value
- 3) Press **ENTER** key.

Delay = 0 hr 23 min 40 sec
Press HOLD to add 3 min Cursor ↑ to change
Cancel

"Hold" is displayed on the LEDs. Press the **RUN** key to cancel the pause and begin infusing. Press the **ENTER** key to cancel the extended pause and return to the standard 3 minute hold. Press the **MENU** key to cancel the pause and access the Menu system.

Micro Rate / Limit

This option is useful in environments where low rates are critical, such as pediatrics or neonatal nurseries. The maximum rate limit can be set as low as 5.0 ml/hr or as high as 99.9 ml/hr.

Note: If the pump is turned on with the Micro Rate Limit activated, a Teddy Bear shows on the LCD screen for 4 seconds.



- 1) Press **HOLD** key
- 2) Press **MENU** key
- 3) Press **CURSOR** keys to select Alternate Menu
- 4) Press **ENTER** key
- 5) Press **CURSOR** keys to select "Micro Rate / Limit"
- 6) Press **ENTER** key

- 1) Press right **CURSOR** key to select On
- 2) Press down **CURSOR** keys to select Rate Limit
- 3) Press **DATA** keys to set a rate limit
- 4) Press **ENTER** key

Set Micro Status: <input type="checkbox"/> Off <input checked="" type="checkbox"/> On
Rate Limit = 59.9 ml/hr
Press ENTER when done

Note: If a rate exists or is entered that is higher than the Rate Limit set, an audible signal occurs. The user will need to lower the rate or exit this feature.

- 1) Press **RUN** key to start the infusion.

MICRO
Time Left = 7 hr 34 min Total Infused = 24.1 ml Occlusion Limit = 300 mmHg

Monitor Docking

Monitor Docking allows the Horizon Nxt® with MedScan to communicate with select monitoring systems to display current infusion parameters. Parameters displayed may vary depending on which monitoring system is being used. Refer to Monitor Docking Guide for operations and troubleshooting.

Set-up

Clamp the Serial Data Communication IR (Infrared) Module over the Serial Data Communication fluid resistant window on the back of the Horizon Nxt pump whose information you wish displayed.

- 1) Grasp the Serial Data Communication IR Module with index finger on top and thumb on grooved surface on the bottom.
- 2) Hook the top of the unit onto the pump, and with thumb press the grooved surface to clamp the bottom of the unit on the pump.

Occlusion Warning

Occlusion Warning is designed to alert the clinician of downstream resistance. An audible warning (three beeps) and visual a indication will occur 5 times at 5-second intervals before alarming "Occlusion." This option must be turned on by the Biomedical Department.

Piggyback Callback

Piggyback Callback, if activated, continues the primary infusion at a KVO rate and causes the pump to alarm. This feature may be accessed during the Run or Hold states.

- 1) Press **MENU** key
- 2) Press the **CURSOR** key to select Alternate Menu
- 3) Press **ENTER** key
- 4) Press **CURSOR** keys to select "Piggyback Callback"
- 5) Press **ENTER** key

- 1) Press **CURSOR** keys to select On
- 2) Press **ENTER** key

When Piggyback Callback is ON, KVO will alarm as soon as the Piggyback is done.

Set Callback: Off On

Note: Piggyback Callback will return to the **Off** position when the pump is turned off.

PROFILE Mode

The Profile Mode is described in Chapter 7 (Special Modes).

PROGRAM Mode

The Program Mode is described in Chapter 7 (Special Modes).

***q(x)*^o Schedule**

This option allows the programming of periodic antibiotics, chemotherapy or other IV infusions. For example, antibiotics are written to be infused "*q 6*^o" (every 6 hours). It is important to have a maintenance IV infusing. This option can only be enabled by Biomedical personnel.

Note: A cassette must be loaded in the pump to program this feature. The piggyback option is not available while using this feature. The *q(x)*^o option cannot be used while in DOSE, PROFILE or PROGRAM Modes.

- 1) Press **HOLD** key
- 2) Press **MENU** key
- 3) Press **CURSOR** keys to select *q(x)*^o Schedule
- 4) Press **ENTER** key

- 1) Press right **CURSOR** keys to select **OK**
- 2) Press **ENTER** key

This feature allows for periods of no infusion. Ensure IV patency prior to start	
<input type="button" value="Cancel"/>	<input type="button" value="OK"/>

To Enter Data:

- 1) Press **CURSOR** keys to select "*q(x)* hrs and min"
- 2) Press the **DATA** keys to set the time interval between infusion. (For example: *q 6 hrs 00 min*)

Dose <i>q(x)</i> 01 hr 00 min # Doses = 4 Dose Rate = 200.0 ml/hr Dose Vol = 100 ml
Press ENTER when done

Note: The time interval can be 1 to 24 hours. There must be at least 15 minutes between each run.

- 1) Press down **CURSOR** key to select "# of Doses"
- 2) Press **DATA** keys to set the total number of doses to be infused.

Note: The total number of doses may not exceed 40.

- 1) Press down **CURSOR** key to select "Dose Rate"
- 2) Press the **DATA** keys to set the infusion rate in ml/hr.

- 1) Press **CURSOR** keys to select "Dose Vol"
- 2) Press the **DATA** keys to set the volume of each dose (for example: 4 doses, each 50 ml)

Note: The Dose Volume of each dose has to be greater than 1 ml but not more than 2000 ml.

- 3) Press the **ENTER** key

To change the time:

- 1) Press up **CURSOR** key to select "Present Time is"
- 2) Press **DATA** keys to set the correct time

Present Time is 09:37a Start dose at 10:35a
VALIDATE

Note: The time is displayed in military time. Use 00:00 to represent

midnight and 12:00 to represent noon. Verify that the Time is correct.

- 1) Press **CURSOR** to select "Start Dose at"
- 2) Press **DATA** keys to set the time the infusion is to begin
- 3) Press the **CURSOR** keys to select "Validate"
- 4) Press **ENTER** key

Note: " $q(x)$ Schedule Overlap" message appears when doses entered are not at least 15 minutes apart. When this occurs the $q(x)$ feature must be exited to cancel the present infusion regimen.

$q(x)$ Schedule Overlap Press HOLD to Silence Alarm	

"Wait Is" shows the amount of time until delivery starts

$q(x)$ Start 10:35a	DATA
Wait Is 0 h 49 m 3 Doses left Total Infused = 2.2 ml	

Note: After pressing Enter, the pump goes into a waiting period. "SCHd dLY" shows on the LED's. No fluid is infusing during this period.

- 1) Press **ENTER** key for the data screen
- 2) Follow the steps above to change the data, if necessary
- 3) Press **ENTER** key

At the $q(x)$ Start time, the pump will begin the infusion. During the infusion "SCHd run" shows on the LED's. The number of doses remaining is shown on the LCD. After the infusion is complete, the pump will automatically return to the waiting period. The pump will continue to "infuse and wait" for the total number of doses entered.

$q(x)$ Delivery	DATA
Time Left = 0 hr 29 min Total Infused = 2.7 ml Occlusion Limit = 300 mmHg 3 Doses left	

To Exit:

Note: The pump must be in the Hold state.

- 1) Press **MENU** key
- 2) Press **CURSOR** keys to select "Exit $q(x)$ ° Schedule
- 3) Press **ENTER** key

Schedule Next Run

This feature lets the user delay an infusion from Standard, DOSE, PROFILE or PROGRAM Mode for up to 24 hours.

Note: The rate and volume information must be entered on either the Primary or Piggyback channel and a set must be in the pump before entering this feature.

- 1) Press **MENU** key
- 2) Press **CURSOR** keys to select Schedule Next Run
- 3) Press **ENTER** key

To Change the Time:

- 1) Press **CURSOR** key to select “Time is”, if necessary
- 2) Press **DATA** keys to set the correct time (in military time)

Schedule Next RUN Time is 15:15p Delay 2 hr 00 min Start at 17:15p
VALIDATE 01 H 00 M DELAY

To Change the Delay:

Note: The time is displayed in military time. Use 00:00 to represent midnight and 12:00 to represent noon.

Either:

Press **CURSOR** keys to select “hr” or “min”
Press **DATA** keys to set the hours and minutes

or

Press **CURSOR** keys to select “Start at”
Press **DATA** keys to change the time

- 1) Press **CURSOR** keys to select “Validate”
- 2) Press **ENTER** key

The information is displayed on the Information Screen, “dLY” is shown, and the yellow Hold LED will blink. Press the **HOLD** key to cancel Schedule Next Run.

Note: To prevent tampering of the Schedule, press the Panel Lock Out Switch on the rear of the pump.

Select MAX Pressure

The Horizon Nxt® with MedScan can be used for epidural administration of anesthetic and analgesic drugs. Use this feature when the maximum pressure of 750 mmHg is required for infusion.

Caution: Whenever the pump is being used for epidural infusions, the pump's secondary infusion features should not be used.

For epidural administration of anesthetic drugs, use indwelling catheters specifically indicated for short-term (96 hours or less) anesthetic epidural drug delivery.

For epidural administration of analgesic drugs, use indwelling catheters specifically indicated for either short-term or long-term analgesic epidural drug delivery.

When the Horizon Nxt with MedScan is being used for epidural infusions, the source container and administration set should be clearly differentiated from source containers and administration sets used for other routes of infusion.

Caution: To prevent inadvertent infusion of drugs not indicated for epidural administration, use only Horizon microbore administration sets without injection sites.

Following an occlusion alarm, a small amount of fluid may be delivered. Use of a microbore set assures this is less than 0.1 mL.

The administration of drugs is restricted to those anesthetic and analgesic drugs labeled for continuous epidural administration.

Warning: Serious injury to the patient may result from epidural administration of drugs other than those specifically labeled for epidural use.

Caution: The higher the pressure limit, the less sensitive the pump is to changes in fluid resistance which may be caused by positional IV's or infiltrations. High pressure limits can increase the severity of an infiltration without an alarm condition.

- 1) Press **HOLD** key
- 2) Press **MENU** key.
- 3) Press **CURSOR** keys to select "Select MAX Pressure"
- 4) Press **ENTER** key

The occlusion pressure is 750 mmHg. To change the occlusion pressure from 750 mmHg, turn the pump off and then on again, or

See “Occlusion Limit” to change the value.

Set PROFILE Parameters

Set PROFILE Parameters is described in Chapter 7 (Special Modes).

Set Time and Volume

Use this feature when an infusion rate is defined by time and volume. The pump calculates the delivery rate.

- 1) Press **HOLD** key
- 2) Press **MENU** key
- 3) Press **CURSOR** keys to select “Set Time and Volume”
- 4) Press **ENTER** key

- 1) Press **CURSOR** keys to select “hr” or “min”
- 2) Press **DATA** keys to enter the correct hours and minutes
- 3) Press **CURSOR** keys to select “ml”
- 4) Press **DATA** keys to enter the volume
- 5) Press **CURSOR** keys to select “VALIDATE”
- 6) Press **ENTER** key.
- 7) Press the **RUN** key to start the infusion.

Set Time and Volume Rate = 125.00 ml/hr Time = 8 hr 00 min Volume = 1000 ml
--

VALIDATE

Site Trend

Site Trend graphically displays the resistance to downstream fluid flow for three intervals of time MAX, MED and MIN.

- 1) Press **MENU** key
- 2) Press the **CURSOR** key to select Alternate Menu
- 3) Press **ENTER** key
- 4) Press **CURSOR** keys to select Site Trend
- 5) Press **ENTER** key

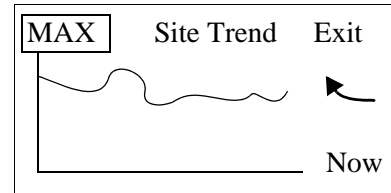

Note: Data is shown from right to left. The word "Now" reinforces the most current data is represented on the right side of the graph. The arrow's position, whether pointing upward or downward, indicates either an increase or a decrease in the downstream fluid resistance.

To Change Graphical Resolution:

- 1) Press up and down **CURSOR** key to change from MAX, MED or MIN resolution

Note: MAX is the default setting. MIN displays more data points compressed along the horizontal axis for a representation of a long-term trend. MAX displays less data points in the same area for a short-term trend.

Resistance Factor (RF):

Note: This feature needs to be activated by the Biomedical Technician.

The Resistance Factor is a numeric value displayed and updated during an infusion. "RF=" appears on either the Hold or Run Screen when activated. The numerical value of RF appears after the words "Site Trend" when the graph is displayed. Increasing RF values may alert the clinician to a possible occlusion state due to kinks, clogged filters, viscous fluids or infiltrations.

To Exit:

- 1) Press right **CURSOR** key to select Exit
- 2) Press **ENTER** key to exit

Exit from Menu

This feature returns the pump to the state it was in before pressing the Menu key.

- 1) Press the **CURSOR** keys to select Exit from menu
- 2) Press the **ENTER** key

Chapter 6 DOSE Mode

DOSE Mode calculates the concentration, rate or dose information necessary for use with many critical drug infusions.

Note: Medication names available are listed in Chapter 9, Table 1.

- 1) Press **HOLD** key
- 2) Press **MENU** key
- 3) Press **CURSOR** keys to select DOSE Mode
- 4) Press **ENTER** key

If a drug name was used the last time in DOSE Mode, the following screen will appear on the LCD:

If the medication is correct:

- 1) Press the **ENTER** key
- 2) Go to Data Screen

DOPAMINE in the ICU/CCU category is the current drug.	
ACCEPT	CHANGE EXIT MODE
Cursor \leftrightarrow & Press ENTER	

or

To change to a new medication:

- 1) Press the **CURSOR** key to select "Change"
- 2) Press **ENTER** key

or

To Exit DOSE Mode:

- 1) Press **CURSOR** key to select "Exit Mode"
- 2) Press **ENTER** key

Drug Menus:

- 1) Press the **CURSOR** key to select a category
- 2) Press **ENTER** key

DRUG LISTS	
ICU/CCU	Neo & Pedi
Med Surg	Oncology
Anesthesia	Epidural
CLEAR DRUG	DOSE

An alphabetical list of medications is shown.

- 1) Press **CURSOR** keys to select the medication.
- 2) Press **ENTER** key

ICU/CCU DRUG LIST
AMINOPHYLLINE
BRETYLIUM
CISPLATIN
DEXAMETHASONE

To clear the drug name:

- 1) Press **CURSOR** key to select "Clear Drug"
- 2) Press **ENTER**
- 3) Go to Data Screen

Note: Generic calculation can be used for drugs not appearing on the list.

Epidural Category:

- 1) Press **CURSOR** key to select "Epidural"
- 2) Press **ENTER**

Pressure will be set to 750 mmHg, and Micro Rate will be enabled.
Use sets labeled for Epidural use only.

Concentration Screen:

A screen with 2 standard concentrations and a "wild card" line is shown

- 1) Press **CURSOR** keys to select a concentration
- 2) Press **ENTER** key

DOPAMINE
400 mg in 500 ml
400 mg in 250 ml
0.0 mg in 0 ml
Press ENTER when done

Note: No data entry can be done here. The concentration can be changed later (See Data Screen.)

Data Screen:

Body Weight:

- 1) Press **CURSOR** keys to select the Body Weight value (if shown)
- 2) Press **DATA** keys to change the value

Body Weight = 70 kg		
Conc = 400.0 mg / 500 ml		
Dose = 5.0 mcg/kg/min		
Rate = 26.3 ml/hr		
VALIDATE	DRUG	SETUP

Calculated Parameter:

Concentration, Dose and Rate are interdependent on each other for their

numeric values. Specifying the amount of two parameters cause the third parameter to be calculated.

For example: Specifying a weight of 70 kg, a concentration of 400 mg of Dopamine in 500 ml of fluid at a dose of 5.0 mcg/kg/min resulted in a calculated rate of 26.3 ml/hr.

Note: Either the Concentration (Conc), Dose or Rate parameter is calculated. Rate is the parameter calculated unless another parameter is chosen.

To Choose Another Parameter:

- 1) Press left **CURSOR** key
- 2) Press up and down **CURSOR** keys to select the parameter to be calculated
- 3) Press the right **CURSOR** key

Note: The parameter that was highlighted is now underlined. That underlined parameter is the calculated parameter.

Enter Data:

- 1) Press **DATA** keys to change value
- 2) Press **CURSOR** key to select
- 3) "VALIDATE "
- 4) Press **ENTER** key
- 5) Press **RUN** key to start the infusion

Body Weight = 70.0 kg Conc = 400.0 mg / 500 ml Dose = 5.00 mcg/kg/min <u>Rate = 26.3 ml/hr</u>		
VALIDATE	DRUG	SETUP

Rate and Volume data is transferred to the displays. The name of the medication and "DOSE" are shown on the Information Screen.

Change SETUP Parameters:

Critical medications require parameters for calculation of doses, for example mcg/kg/min. Three categories of parameters are Dosage, Concentration (Conc) and Body. Each of these can be independently selected and changed. Match the dosage and concentration written by the doctor.

- 1) Press **HOLD** key
- 2) Press **MENU** key
- 3) Press **CURSOR** keys to select DOSE Mode
- 4) Press right **CURSOR** key to select SETUP
- 5) Press **ENTER** key

- 1) Press the left or right **CURSOR** keys to move to the appropriate parameter
- 2) Press the up or down **CURSOR** keys to change to the correct parameters (mcg/kg/min to units/hr)
- 3) Press **ENTER** key

DOSAGE	CONC	BODY
mcg/kg/min	mg	kg
↑	change	↔ move
Press ENTER when done		

Titrate Rate:

The rate can be titrated while the pump is running. Press the **DATA** keys to change the rate. The dose is recalculated and shown. The **ENTER** key or **RUN** key must be pressed within four seconds to validate the change. Once made, the pump infuses at the new rate.

Note: If the **ENTER** key or **RUN** key is not pressed within 4 seconds of entering a new rate, a series of error beeps will occur and the rate change will be cancelled. The pump will then display the message "Rate change aborted", and will continue to infuse at the old rate. An intermittent alarm will continue to sound to notify the user that a rate change has been attempted and cancelled. Pressing any key will silence the alarm.

Titrate Dose:

- 1) Press **ENTER** key
- 2) Press **CURSOR** keys to select the Dose value
- 3) Press **DATA** keys to change the values
- 4) Press **CURSOR** keys to select "VALIDATE"
- 5) Press **ENTER** key

Monitor the infusion as indicated by hospital policy. The pump will alarm and go into the KVO state when the volume is infused. "KVO: DOSE COMPLETE" is shown on the Information Screen.

- 1) Press the **HOLD** key
- 2) Press the **DATA** keys to put in a new volume
- 3) Press **RUN** key to start infusion

Exit DOSE Mode:

- 1) Press **HOLD** key
- 2) Press **MENU** key
- 3) Press **CURSOR** keys to select "Exit DOSE Mode"
- 4) Press **ENTER** key. The pump will return to the standard Hold state

Chapter 7 SPECIAL MODES

PROFILE Mode

This mode lets the user deliver fluid in a ramped delivery pattern (ramp up, plateau deliver, and ramp down) over a selected period of time.

If the pump was turned off while in the PROFILE Mode, the following screen will appear:

- 1) Press **CURSOR** keys to select the appropriate message
- 2) Press **ENTER** key

PROFILE Operation was Interrupted
Resume current PROFILE Restart PROFILE Exit PROFILE Mode

The pump will return to PROFILE Hold state.

Change PROFILE Parameters:

- 1) Press **Menu** key
- 2) Press **Cursor** keys to select Set PROFILE Parameters
- 3) Press **Enter** key

- 1) Press the **Cursor** keys to select Ramp Up, Ramp Down or MAX Rate
- 2) Press **Data** keys to change the values
- 3) Press **Cursor** keys to select "VALIDATE Parameters"
- 4) Press **Enter** key

Ramp Up = 1 hr 0 min Ramp Down = 1 hr 0 min Max Rate = 300 ml/hr
VALIDATE Parameters

Note: The minimum ramp time is 10 minutes; the maximum ramp time 120 minutes. The largest value for maximum rate is 400 ml/hr.

Data Entry:

- 1) Press **MENU** key
- 2) Press **CURSOR** keys to select "PROFILE Mode"
- 3) Press **ENTER** key

- 1) Press **DATA** keys to enter the Volume
- 2) Press **CURSOR** keys to select time
- 3) Press **DATA** keys to enter the Time
- 4) Press the **CURSOR** keys to select "VALIDATE PROFILE"
- 5) Press the **ENTER** key

Volume = 1000.0 ml Time = 8 hr 0 min
VALIDATE PROFILE

“Profile Ready” will appear at top of Information Screen.

Press **RUN** key to start. “PROFILE RAMP UP” will be displayed on the Information Screen.

- 1) Press **ENTER** key for a graph
- 2) Press **ENTER** key for the text

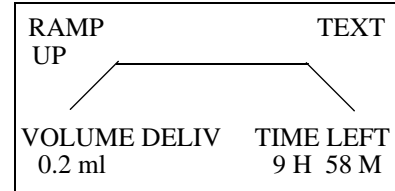

Review/Change PROFILE Data:

Note: Volume cannot be changed after an infusion is started.

- 1) Press **MENU** key
- 2) Press **CURSOR** keys to select “Review/Change PROFILE”
- 3) Press **ENTER** key

- 1) Press **CURSOR** keys to select Time
- 2) Press **DATA** keys to change the time
- 3) Press the **CURSOR** keys to select "VALIDATE PROFILE"
- 4) Press the **ENTER** key
- 5) Press **RUN** to start

Restart PROFILE:

- 1) Press **HOLD** key
- 2) Press **MENU** key
- 3) Press **CURSOR** keys to select "Restart PROFILE"
- 4) Press **ENTER** key

- 1) Press **CURSOR** keys to select "YES"
- 2) Press **ENTER** key
- 3) Press **RUN** key

The "Restart PROFILE" option will cancel the present run. Is this OK? Yes No
Cursor ↔ & Press Enter

Immediate Ramp Down:

- 1) Press the **MENU** key
- 2) Press the **CURSOR** keys to select "Immediate Ramp Down"
- 3) Press the **ENTER** key

“Immediate Ramp Down” shows on the Information Screen.

Note: The Immediate Ramp Down time is 30 minutes or less.

Upon completion of Immediate Ramp Down, the pump enters the KVO state. To silence the alarm, press the **HOLD** key.

Exit PROFILE Mode:

- 1) Press **HOLD** key
- 2) Press **MENU** key
- 3) Press **CURSOR** keys to select "Exit PROFILE Mode"
- 4) Press **ENTER** key

- 1) Press **CURSOR** keys to select "YES"
- 2) Press **ENTER** key

The "Exit PROFILE mode" option will cancel the present run. Is this OK? Yes No Cursor ↔ & Press Enter

The pump will return to the standard Hold state. _____

PROGRAM Mode

This mode lets the user program up to nine different rates and volumes. The pump will deliver the fluid sequentially. Fluid delivery can be customized for each patient.

If the pump was turned off while in the PROGRAM Mode, this screen will appear:

- 1) Press **CURSOR** keys to select the appropriate message
- 2) Press **ENTER** key

PROGRAM Operation was Interrupted
Resume current PROGRAM
Restart PROGRAM
Exit PROGRAM Mode

The pump will return to Program Hold state.

- 1) Press **MENU** key
- 2) Press **CURSOR** keys to select "PROGRAM Mode"
- 3) Press **ENTER** key

Data Entry:

- 1) Press **CURSOR** keys to select Rate or Volume
- 2) Press **DATA** keys to change the values
- 3) Press **CURSOR** keys to select the next period
- 4) Repeat until all information is entered (up to 9 periods)

Pd.	Rate	Volume
1	0.0	0.0 ZERO
2	0.0	0.0
3	0.0	0.0
VALIDATE TOTAL = 0.0 ml		

Note: VALIDATE cannot be selected when 0.0 data is present in the middle of a Program, for example:

NOT ALLOWED

Pd.	Rate	Volume
1	50.0	35.0
2	0.0	0.0
3	30.0	150.0 ZERO
VALIDATE TOTAL = 0.0 ml		

NOT ALLOWED

Pd.	Rate	Volume
1	50.0	35.0
2	35.0	0.0
3	30.0	500.0 ZERO
VALIDATE TOTAL = 0.0 ml		

ALLOWED

Pd.	Rate	Volume
1	50.0	35.0
2	100.0	500.0
3	0.0	0.0 ZERO
VALIDATE TOTAL = 0.0 ml		

- 1) Press **RUN** key to start the infusion
- 2) Period 1 is infusing as displayed
- 3) Press **ENTER** key to display a graph
- 4) Press **ENTER** key to return to the text display

Each period is represented by a vertical bar which fills as the fluid is infused. The height of the bar represents the rate of infusion in that particular period. The period presently being infused is displayed in the upper left corner. If the vertical bar appears to be missing, the rate in that period is much less compared to the other periods.

Review/Change PROGRAM:

Note: A Program cannot be changed after it has been started.

- 1) Press **MENU** key
- 2) Press **CURSOR** keys to select “Review/Change PROGRAM”
- 3) Press **ENTER** key

- 1) Press **CURSOR** keys to select rate
- 2) Press **DATA** keys to change the rate values
- 3) Press **ENTER** key

Note: Only rate can be changed after an infusion has started

- 4) Press **CURSOR** keys to select “Validate”
- 5) Press **ENTER** key

Restart PROGRAM:

- 1) Press **HOLD** key
- 2) Press the **MENU** key
- 3) Press **CURSOR** keys to select "Restart PROGRAM"
- 4) Press **ENTER** key

- 1) Press **CURSOR** keys to select "Yes"
- 2) Press **ENTER** key
- 3) Press **RUN** key

The "Restart PROGRAM" option will cancel the present run. Is this OK?
 Yes No
 Cursor ↔ & Press ENTER

Skip PROGRAM Periods:

- 1) Press **HOLD** key
- 2) Press **MENU** key
- 3) Press **CURSOR** keys to select "Skip PROGRAM Periods"
- 4) Press **ENTER** key

- 1) Press the **DATA** keys for VTBD to remove the volume
- 2) The bar on the graph moves to show the volume skipped
- 3) Press **ENTER** key
- 4) Press **RUN** key

 Skip 0.0 ml / 12.0 left
 Press ENTER when done

Upon completion of the program, the pump enters the KVO state. Press the **HOLD** key

Exit PROGRAM Mode:

- 1) Press **HOLD** key
- 2) Press **MENU** key
- 3) Press **CURSOR** keys to select "Exit PROGRAM Mode"
- 4) Press **ENTER** key

Chapter 8 MAINTENANCE

Cleaning

Clean the pump with a soft, lint-free cloth or swab dampened with soap and water, a general nonstaining chemical disinfectant, or alcohol (90% concentration or less.). **DO NOT use acetone solutions containing glutaraldehyde, ammonium chlorides or abrasive cleansers on the pump.** If you feel it necessary, Betadine or Iodine solutions may be used, but they will stain the device.

As a general recommendation for cleaning and disinfection of this device, use a lintfree cloth dampened with a 0.5% Sodium Hypochlorite solution (one part bleach with nine parts water). The solution is most effective when prepared weekly and allowed to remain on the device for approximately 10 minutes prior to wiping off. Please be sure NOT to use abrasive cleaning tools or pressurized spraying devices for these may damage the pressure transducer or cause fluid intrusion.

Warning: To avoid mechanical or electronic damage, do not steam autoclave or immerse the pump in any fluids or cleaning solutions.

Caution: To avoid electrical shock, turn off the pump and disconnect it from the electrical outlet before cleaning.

Sterilization of the pump using ethylene oxide (EtO) gas is not recommended.

Alarm Procedures

An alarm notifies the user that the condition indicated on the Information Display has occurred and that corrective action must be taken to continue the infusion process.

When an alarm condition occurs, the following steps are recommended:

- 1) Press the **HOLD** key.
- 2) Press the **MENU** key to display on the Information Display the correction messages contained in the “Correction” column of the Troubleshooting Guide.
- 3) Correct the cause of the alarm.
- 4) Press the **RUN** key to restart the infusion.
- 5) Monitor the process according to hospital policy.

There are 3 types of alarms:

- 1) Operation alarms - Press the **MENU** key to see the Help Screen which contains the guidelines in the “Correction” column of the Alarm Troubleshooting Guide. Clear the alarm by pressing the **HOLD** key.
- 2) System alarm - Press the **HOLD** key, and press the **RUN** key to restart the infusion.
- 3) Repair Instrument alarm - Press the **HOLD** key and turn the pump off and then on again (Similar to rebooting a personal computer.). If the alarm recurs, return the pump to a Biomedical Professional for service.

For assistance, call (800) 627-PUMP.

Alarm Troubleshooting Guide

MESSAGE	LED MESSAGES	CORRECTION
Air-in-Line	Air	Air in downstream tubing Tubing improperly inserted in Air-in-Line Detector.
Battery Very Low	Use AC	Plug into AC power NOW to continue operation
Container Empty	SOLU	Check for air in set IV container empty Check upstream clamp Check cassette installation
Door Open	door	The door must be shut to deliver fluid
Downstream Occlusion	OCCL	Clamp closed or filter blocked Tubing kinked IV positional or infiltrated Catheter or vein too small Check occlusion limit
Hold Time Exceeded	HOLD	Press Hold key, three minute time period is restarted
KVO	flashing LED's	Pump is operating in Keep Vein Open state Infusion is complete Set volume to be delivered Restart or turn off the pump
Low Battery	PLUG IN	Battery too low; plug in AC
System Error	SYS Err	Turn the pump off and return to Biomedical Professional for service
See Help	SEE HELP	CLOSE ROLLER CLAMP, then open door. Press LOAD and reload tubing. Cassette not in place
Set Piggyback Rate		Set a Piggyback rate

Set Piggyback Volume		Set a Piggyback volume
Set Primary Rate		Set a Primary rate
Set Primary Volume		Set a Primary volume

Cautions

Before using the pump in a clinical setting, the user should become thoroughly familiar with the proper use of the device as outlined in this Operation Manual.

The Horizon Nxt® Infusion Pump is not intended to substitute for regular patient observation and evaluation.

Do not attempt to infuse two fluids simultaneously using the Horizon Nxt Infusion Pump.

Each time the pump is turned on, verify that the alarm sounds during the momentary test sequence. If the alarm continues to sound or an alarm message is displayed, refer to Alarm Procedures.

Unrestricted fluid flow may occur if the I.V. set is not properly installed.

Whenever the pump is being used for epidural infusion, the pumps' secondary infusion features should not be used.

To prevent inadvertent infusion of drugs which are not indicated for epidural use, only Horizon microbore administration sets without injection sites are required for epidural administration of drugs. Following an occlusion alarm a small amount of fluid may be delivered. Use of a microbore set assures this is less than 0.1 mL.

Serious injury to the patient may result from epidural administration of drugs other than those specifically labeled for epidural use.

It is not recommended to stack more than five pumps on one I.V. pole.

Use only with B. Braun Medical Horizon® I.V. Sets

Perform testing and/or preventive maintenance as defined in the product Service Manual. It is necessary to perform all testing and preventive maintenance as defined in the product Service Manual, or the reliability and proper functionality of the unit cannot be assured.

The higher the maximum pressure limit, the less sensitive the pump is to changes in fluid resistance which may be caused by positional I.V.'s or infiltrations. High pressure limits can increase the severity of an infiltration without causing an alarm condition.

Unless the pump is plugged into a hospital-grade electrical outlet the reliability of the grounding cannot be assured.

A possible explosion hazard exists if the pump is used in the presence of flammable anesthetics.

To avoid electrical shock, turn off the pump and disconnect it from the

electrical outlet before cleaning.

Do not use the pump in the presence of strong electromagnetic fields. The field may permanently damage the pump. For further information, consult the manufacturer of the equipment in question.

To avoid mechanical or electronic damage, do not steam autoclave or immerse the pump in any fluids or cleaning solutions.

A possible electrical shock hazard exists if the case of the pump is opened or removed. Refer all servicing to authorized service personnel.

Do not use visibly damaged pumps or pumps with bent, damaged or missing components.

Pumps should be tested for proper performance semiannually.

Federal (U.S.A.) law restricts this device to sale by or on the order of a physician.

Service and Performance Information

If the pump fails to respond to the operating or troubleshooting procedures listed in this manual and the cause cannot be determined, discontinue using the pump and forward it to an authorized B.Braun Medical Service Center.

Should it be necessary to return the pump for repair, contact Customer Service at the phone number below for a Returned Goods Authorization (RGA) number, then carefully pack the pump (preferably in the original packing), and ship it prepaid to the address below. B. Braun Medical cannot assume any responsibility for loss or damage to returned instruments while they are in transit.

Service and product performance information, operation training, service training, and service manuals may be obtained from the manufacturer by contacting:

B. Braun Medical Inc.
1601 Wallace Drive, Suite 150
Carrollton, Texas 75006 USA
Attn: Manager of Service
Or call: (800) 627-PUMP

Product complaints may be sent to the Manager of Quality Assurance at the above address. With each complaint, please include:

- 1) The pump's serial number
- 2) Software Revision
- 3) A description of the difficulty experienced
- 4) The pressure limit setting
- 5) The rate setting
- 6) The initial volume(s) to be infused
- 7) The type of fluid(s)
- 8) The amount of time between the start of the infusion and the time the difficulty was noticed
- 9) The message displayed at the time the difficulty occurred
- 10) The catalog and lot number of the set(s) in use
- 11) Any other information which might aid in the investigation of the complaint

Specifications

Mechanism:	Volumetric (Non Drop-Counting), Positive Pressure Displacement Reservoir
Dimensions:	Width 12.4" (31.5 cm) Height 4.8 (12.2 cm) Depth 12.2" (31.5 cm)
Weight:	Approximately 11.9 lb. (5.4 Kg)
Power Requirements:	90-132 VAC, 30 Watts, 47/63 Hz excluding accessories (domestic), 180- 264 VAC, 30 Watts, 47/63 Hz excluding accessories (International)
Grounding Resistance	Meets UL Standard 544
Leakage Current:	Meets or exceeds UL Standard 544, Section 27.2, and ANSI/AAMI Safe Current Limits (July 9, 1985)
Plug:	Hospital Grade (3 pin)
Pole Size Range:	0.75" to 1.25"
Battery:	12 Volt sealed lead-acid battery for ambulatory use. Run time is dependent on the state of battery charge and the rate of fluid delivery.
Rate Range:	Standard: (Primary and Piggyback) 0.1 to 999.9 mL/hr Micro: (Primary and Piggyback) 0.1 to 99.9 mL/hr
Volume to be Infused Range:	0.1 to 9999.9 mL
Occlusion Pressure	75, 100, 200, 300, 400, 500 and 750 mmHg Standard mode default is 300 mmHg.
Keep Open Rate:	3 mL/hr for prescribed delivery rates of 3 to 999.9 mL/hr, or the continuation of the prescribed delivery rate for 0.1 to 2.9 mL/hr settings.
Volume Delivered Accuracy:	+/- 5%
Fluid Types:	All standard I.V. fluids

Alarms:	Air-In-Line, Container Empty, Door Open, Downstream Occlusion, Hold Time Exceeded, Low Battery, Low Flow from Container, Close Roller Clamp, Sys Err, Upstream Occlusion
Air-in-Line Alarm:	0.09 cc
Hold Time Exceeded Alarm:	Activated after three minutes on hold without user interaction (deactivated if the door of the pump is open)
Memory:	Permanent data retention after the pump is turned off, unless the battery is depleted or disconnected, or unless the Data Retention Defaults have been otherwise selected in the Biomed Options.

Chapter 9 Table 1
Drug List

Name	Concentration	Dosage Units
Alfentanil	3.5 mg in 7 ml 500 mcg in 1 ml 0 mg in 0 ml	mcg/kg/min
Aminocaproic Acid	15 g in 500 ml 15 g in 250 ml 0 g in 0 ml	g/hr
Aminophy (mg/hr)	500 mg in 500 ml 500 mg in 250 ml 0 mg in 0 ml	mg/hr
Aminophy (mg/kg/hr)	500 mg in 500 ml 500 mg in 250 ml 0 mg in 0 ml	mg/kg/hr
Amiodarone	150 mg in 100 ml 900 mg in 500 ml 0 mg in 0 ml	mg/min
Amrinone	500 mg in 500 ml 500 mg in 250 ml 0 mg in 0 ml	mcg/kg/min
Bretylium	2 g in 500 ml 4 g in 500 ml 0 g in 0 ml	mg/min
Cisplatin	0 mg in 1000 ml 0 mg in 500 ml 0 mg in 250 ml	mg/m ² /hr
Cyclophosphamide	0 mg in 0 ml 0 mg in 0 ml 0 gm in 0 ml	mg/kg/min
Dexamethasone	0 mg in 0 ml 0 mg in 0 ml 0 mg in 0 ml	mg/kg/hr
Diltiazem	125 mg in 125 ml 250 mg in 250 ml 0 mg in 0 ml	mg/hr

Name	Concentration	Dosage Units
Dobutamine	500 mg in 500 ml 500 mg in 250 ml 0 mg in 0 ml	mcg/kg/min
Dopamine	400 mg in 500 ml 400 mg in 250 ml 0 mg in 0 ml	mcg/kg/min
Doxorubicin	0 mg in 0 ml 0 mg in 0 ml 0 mg in 0 ml	mg/m TM /min
Epinephrine 1:1000	3 mg in 250 ml 6 mg in 250 ml 0 mg in 0 ml	mcg/min
Esmolol	5 g in 500 ml 5 g in 250 ml 0 mg in 0 ml	mcg/kg/min
Etoposide (VP-16)	0 mg in 0 ml 0 mg in 0 ml 0 mg in 0 ml	mg/m ² /hr
Fentan (mcg/kg/min)	50 mcg in 1 ml 2.5 mg in 50 ml 2.5 mg in 50 ml	mcg/kg/min
Fentan (mcg/kg/hr)	50 mcg in 1 ml 2.5 mg in 50 ml 2.5 mg in 50 ml	mcg/kg/hr
Fluorouracil (5-FU)	0 mg in 0 ml 0 mg in 0 ml 0 mg in 0 ml	mg/kg/hr
Furosemide	100 mg in 50 ml 0 mg in 0 ml 0 mg in 0 ml	mg/min
Heparin (units/hr)	20,000 units in 500 ml 25,000 units in 250 ml 0 units in 0 ml	units/hr
Heparin (units/kg/hr)	20,000 units in 500 ml 25,000 units in 250 ml 0 units in 0 ml	units/kg/hr

Name	Concentration	Dosage Units
Hydromorphone	50 mg in 5 ml 500 mg in 50 ml 0 mg in 0 ml	mg/hr
Insulin (Regular)	0 units in 0 ml 0 units in 0 ml 0 units in 0 ml	units/hr
Isoproterenol	3 mg in 250 ml 6 mg in 250 ml 0 mg in 0 ml	mcg/min
KCL	20 mEq in 50 ml 40 mEq in 100 ml 0 mEq in 0 ml	mEq/hr
Labetalol	200 mg in 200 ml 200 mg in 250 ml 0 mg in 0 ml	mg/min
Lidocaine	2 gm in 500 ml 4 gm in 500 ml 0 gm in 0 ml	mg/min
Magnesium Sulfate	5000 mg in 250 ml 5000 mg in 500 ml 0 mg in 0 ml	g/hr
Methotrexate	0 mg in 0 ml 0 mg in 0 ml 0 mg in 0 ml	mg/kg/min
Midazolam	25 mg in 50 ml 50 mg in 50 ml 0 mg in 0 ml	mg/hr
Milrinone	10 mg in 10 ml 20 mg in 100 ml 0 mg in 0 ml	mcg/kg/min
Morphine	10 mg in 50 ml 10 mg in 1 ml 0 mg in 0 ml	mg/hr
NTG (mcg/min)	50 mg in 250 ml 100 mg in 250 ml 0 mg in 0 ml	mcg/min

Name	Concentration	Dosage Units
NTG (mcg/kg/min)	50 mg in 250 ml 100 mg in 250 ml 0 mg in 0 ml	mcg/kg/min
Nitroprusside	200 mg in 500 mg 50 mg in 250 ml 0 mg in 0 ml	mcg/kg/min
Norepinephrine	8 mg in 500 ml 8 mg in 250 ml 0 mg in 0 ml	mcg/min
Ondansetron	32 mg in 50 ml 0 mg in 0 ml 0 mg in 0 ml	mg/kg/hr
Oxytocin	10 units in 1000 ml 10 units in 500 ml 0 units in 0 ml	millU/min
Phenylephrine	30 mg in 500 ml 50 mg in 500 ml 0 mg in 0 ml	mcg/min
Procainamide	2 g in 500 ml 4 g in 500 ml 0 g in 0 ml	mg/min
Propofol (mg/kg/min)	200 mg in 20 ml 600 mg in 60 ml 0 mg in 0 ml	mg/kg/min
Propofol (mcg/kg/min)	200 mg in 20 ml 600 mg in 60 ml 0 mg in 0 ml	mcg/kg/min
Propranolol	15 mg in 500 ml 15 mg in 250 ml 0 mg in 0 ml	mg/hr
Ranitidine	50 mg in 100 ml 150 mg in 1000 ml 0 mg in 0 ml	mg/hr
Sufentanil	250 mcg in 5 ml 50 mcg in 1 ml 0 mcg in 0 ml	mcg/kg/hr

Name	Concentration	Dosage Units
Urokinase	750,000 units in 500 ml 300,000 units in 200 ml 0 units in 0 ml	units/kg/hr
Vasopressin	150 units in 250 ml 200 units in 250 ml 0 units in 0 ml	milli U/min
Vercuronium	5 mg in 5 ml 10 mg in 5 ml 0 mg in 0 ml	mcg/kg/min

Caution: Federal Law restricts this device to
sale by or on the order of a physician.

B.Braun Medical Inc.
Carrollton, TX USA 75006

INDEX

A

Air-In-Line, 2-3
Alarm Procedure, 8-2
Alarm Volume, 4-1, 4-2
Alternate Menu, 4-1

B

Battery Operation, 2-4
Blood Infusion, 1-3
Body Surface Area (BSA), 4-1, 4-4

C

Calculate BSA, 4-1, 4-4
Cassette Alignment Pins, 2-3
Cassette Removal, 3-1
Change Alarm Volume, 4-1, 4-2
Changing the Rate, 3-3
Check Battery Level, 5-1, 5-2
Clear Total Infused, 4-1, 4-2

D

Daisy Chaining, 2-4
Data Keys, 2-2, 2-4
Dose Mode, 2-1, 4-1, 6-1
 Body Weight, 6-2
 Calculated Parameter, 6-2
 Change Medication, 6-1
 Change SETUP Parameters, 6-3
 Clear Medication, 6-1
 Concentration Screen, 6-2
 Data Screen, 6-2
 Drug Menus, 6-1
 Enter Data, 6-3
 Epidural, 6-2
 Exit Dose Mode, 6-4
 Titrate Dose, 6-4
 Titrate Rate, 6-4

E

Enter Key, 2-2, 2-4
Epidural Administration, 1-2, 5-9, 6-2

F

Free Flow Protection Clip, 2-3

H

Hold Extender, 5-1, 5-3

I

Illustrations

Front View, 2-2

Rear View, 2-3

Inside the Door, 2-3

K

KVO, 2-1

L

LCD Contrast, 4-1, 4-4

M

Menu Key, 2-2, 2-4

Micro Rate / Limit, 5-1, 5-3

Monitor Docking, 5-4

O

Occlusion limit, 4-1, 4-3

Occlusion Warning Notification, 5-1, 5-4

P

Panel Lockout Switch, 2-3

Piggyback Callback, 3-3, 5-1, 5-5

Piggyback Fluids, 3-2

Piggyback Indicator Key, 2-2

Power Key, 2-2, 2-4

Profile Mode, 5-1, 7-1

Change Profile Parameters, 7-1

Data Entry, 7-1

Exit PROFILE Mode, 7-3

Immediate Ramp Down, 7-2

Restart PROFILE, 7-2

Review/Change PROFILE Data, 7-2

Set Profile Parameters, 7-1

Program Mode 5-1, 7-4

Data Entry, 7-4

Exit PROGRAM Mode, 7-6

Restart PROGRAM, 7-6

Review/Change PROGRAM, 7-5

Skip PROGRAM Periods, 7-6

Q

$q(x)$ ° Schedule, 5-1, 5-5

S

Schedule Next Run, 5-1, 5-9

Select MAX Pressure, 5-1, 5-10

Set Time & Volume, 5-1, 5-11

Site Trend, 5-1, 5-12

Standard Mode, 2-1

 For Primary Fluids, 3-2

 For Piggyback Fluids, 3-2

Sympathetic flow, 3-3

T

Titration, 3-3, 6-4



Artisan Technology Group is your source for quality new and certified-used/pre-owned equipment

- FAST SHIPPING AND DELIVERY
- TENS OF THOUSANDS OF IN-STOCK ITEMS
- EQUIPMENT DEMOS
- HUNDREDS OF MANUFACTURERS SUPPORTED
- LEASING/MONTHLY RENTALS
- ITAR CERTIFIED SECURE ASSET SOLUTIONS

SERVICE CENTER REPAIRS

Experienced engineers and technicians on staff at our full-service, in-house repair center

*InstraView*SM REMOTE INSPECTION

Remotely inspect equipment before purchasing with our interactive website at www.instraview.com ↗

WE BUY USED EQUIPMENT

Sell your excess, underutilized, and idle used equipment. We also offer credit for buy-backs and trade-ins. www.artisanng.com/WeBuyEquipment ↗

LOOKING FOR MORE INFORMATION?

Visit us on the web at www.artisanng.com ↗ for more information on price quotations, drivers, technical specifications, manuals, and documentation

Contact us: (888) 88-SOURCE | sales@artisanng.com | www.artisanng.com