



## Artisan Technology Group is your source for quality new and certified-used/pre-owned equipment

- FAST SHIPPING AND DELIVERY
- TENS OF THOUSANDS OF IN-STOCK ITEMS
- EQUIPMENT DEMOS
- HUNDREDS OF MANUFACTURERS SUPPORTED
- LEASING/MONTHLY RENTALS
- ITAR CERTIFIED SECURE ASSET SOLUTIONS

### SERVICE CENTER REPAIRS

Experienced engineers and technicians on staff at our full-service, in-house repair center

### *InstraView*<sup>SM</sup> REMOTE INSPECTION

Remotely inspect equipment before purchasing with our interactive website at [www.instraview.com](http://www.instraview.com) ↗

### WE BUY USED EQUIPMENT

Sell your excess, underutilized, and idle used equipment. We also offer credit for buy-backs and trade-ins. [www.artisanng.com/WeBuyEquipment](http://www.artisanng.com/WeBuyEquipment) ↗

### LOOKING FOR MORE INFORMATION?

Visit us on the web at [www.artisanng.com](http://www.artisanng.com) ↗ for more information on price quotations, drivers, technical specifications, manuals, and documentation

**Contact us:** (888) 88-SOURCE | [sales@artisanng.com](mailto:sales@artisanng.com) | [www.artisanng.com](http://www.artisanng.com)

# Triton SLA

## Contents

	Page
<b>The cleaner</b>	
Availability and accessories .....	12
Description of equipment .....	13
Technical data .....	13
<b>Operation</b>	
Safety notes .....	14
Installation .....	15
Operation .....	16
Care and maintenance .....	18
Remedying faults .....	20

## Availability

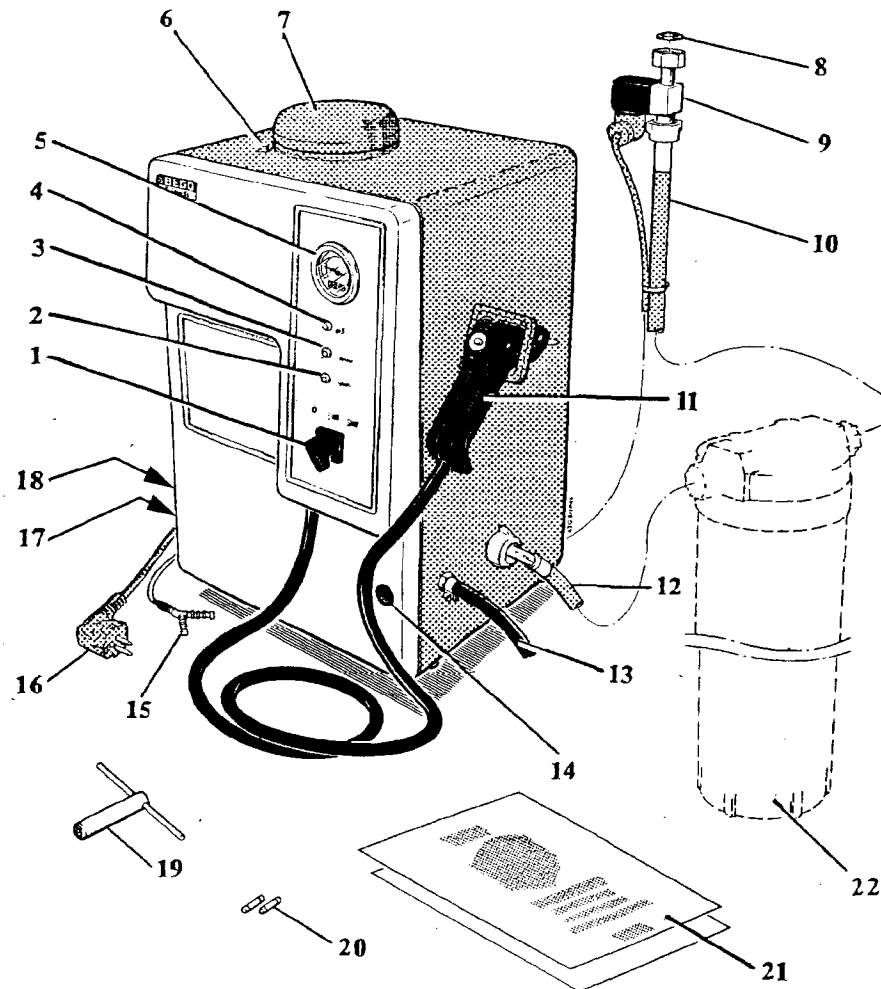

Triton SLA (230 V), including BEGO full demineralisation cartridge ..... Order No. 26 005  
 Triton SLA (110 V), including BEGO full demineralisation cartridge ..... Order No. 26 006

## Accessories

BEGO full demineralisation cartridge, with 2 inserts and ring spanner ..... Order No. 37 600  
 2 new inserts ..... Order No. 37 602  
 2 replacement inserts ..... Order No. 37 602 T  
 6 litres of Durox replacement non-reusable resin ..... Order No. 52 121  
 Ring spanner ..... Order No. 11 044

## Description of equipment

- |  |   |
|--|---|
| 1 Main switch  | 13 Waste hose                                       |
| 2 Heating indicator light                                  | 14 Drain cock                                       |
| 3 Indicator light for maximum water level                  | 15 Water leak detector                              |
| 4 $\mu\text{S}$ * indicator light (conductivity/Waterstop) | 16 Mains plug                                       |
| 5 Pressure gauge   | 17 Fuses  |
| 6 Cover locking button                                     | 18 Temperature limiter                              |
| 7 Screw cover  | 19 Key for drain cock                               |
| 8 Seal with strainer                                       | 20 Spare fuses                                      |
| 9 Waterstop valve  | 21 Documentation                                    |
| 10 Supply hose   | 22 BEGO full demineralisation cartridge (accessory) |
| 11 Steam gun   |   |
| 12 Hose for full demineralisation cartridge                |   |
- \*  $\mu\text{S}$ : international unity for electrical conductivity

**NB** Please retain the original packing for future transportation!

The Triton SLA is a versatile steam cleaner for the dental laboratory. Objects are cleaned and degreased with dry stream. Wet stream removes wet residues and stubborn dirt effectively.

**Important:** In order to avoid any damages by furring up, the Triton SLA has to be run with full demineralized water. This is guaranteed when taking the BEGO-full demineralization cartridge. Triton SLA is then automatically filled with water and used up water is replaced. In case that other demineralization systems are applied, they have to ensure a conductivity from 0 up a maximum of 20  $\mu\text{S}$ .

The Triton SLA is fitted with several safety devices:

- If the permissible operating pressure is exceeded the supply of water is interrupted and the heating switched off (switching range  $3.5 \pm 0.2$  bar).
- A safety valve opens at 4.4 bar.
- If the boiler is heated without any water, a temperature limiter switches the heating off.
- A water leak detector, which is placed on the floor under the cleaner, measures electrical conductivity ( $\mu\text{S}$ ) and switches the water supply off automatically in the event of a leak ( $\mu\text{S}$  indicator light comes on).
- If the full demineralisation cartridge is being used, the supply of water is interrupted when its resin is spent ( $\mu\text{S}$  indicator light comes on).

## Technical data

Height _____	540 mm	Boiler temperature at pressure of 3 bar	$\_ 133$ °C
Width _____	380 mm	Steam pressure _____	$3 \pm 0.2$ bar (abt. 0.3 MPa)
Depth _____	280 mm	Boiler capacity _____	2.9 l
Rated voltage _____	200 .... 240 V, 50/60 Hz	Water supply _____	$3/4"$ , 4 - 6 bar
Special voltage _____	100 .... 120 V, 50/60 Hz	Weight _____	13 kg
Power consumption at rated voltage _____	1.5 kW		



## Safety notes



1. The Triton SLA is only intended for steam cleaning of dental and comparable objects. Any other use is deemed to be other than that intended and we accept no liability for any damage to property or personal injury this may cause.

2. The Triton SLA may only be used by employees familiar with the contents of these Operating Instructions.

3. The Triton SLA may only be modified with our prior consent. We accept no liability for damage to property or personal injury that may result from unauthorized modification.

4. The national accident prevention regulations are to be observed in addition to these Operating Instructions.

5. Plates and labels must be kept in easily legible condition at all times. They must not be removed.

6. **CAUTION - RISK OF SCALDING!** Before starting work hold steam gun in a sink and press trigger. Do not start work until the steam is being emitted evenly. Never hold the object to be cleaned with your fingers when cleaning with wet steam!

7. **Do not open the cleaner until the pressure has dropped to zero!** Ensure that the pressure gauge reads 0 bar or less before opening the cover, the demineralisation system or the drain cock.

8. In the **Federal Republic of Germany** the Triton SLA is subject to the steam boiler regulations. Its marking and equipment comply with the regulations for Group 1 steam boilers according to TRD 801. The water pressure test is carried out on each cleaner by BEGO Quality Control Department and a certificate provided also shows that it has been manufactured properly. The certificate enclosed is to be kept in a safe place.

§ 15, Para 3 of the Steam Boiler Regulations stipulates that certification of proper installation is also required. The "Installation Certificate" enclosed must be signed by the fitter who has installed and connected the Triton SLA. The certificate is to be kept in a safe place by the operator.

## Installation

### Conditions:

- Water supply 3/4", 4-6 bar  
**NB:** Minimum water pressure 4 bar. A pressure-reducing valve must be connected if the water pressure exceeds 6 bar.
- See name plate for mains electricity supply data.
- Fit full demineralisation cartridge to avoid scaling.  
**Important:** Other demineralisation systems have to guarantee conductivity  $\leq 20 \mu\text{S}$ !

In the **Federal Republic of Germany** proper installation must be certified using the "Installation Certificate" enclosed.

Position or wall-mount Triton SLA so that the steam gun can be used over a sink.

**NB:** The wall must be washable, since hot air is blown out of the back of the cleaner.

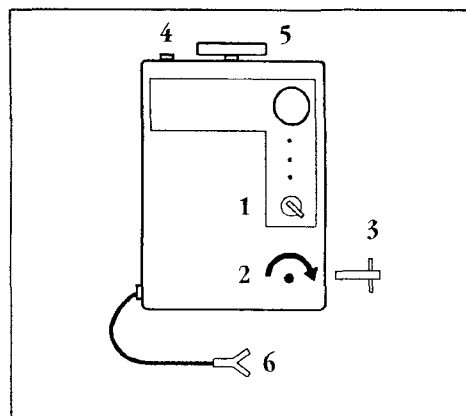

- 1 Turn switch to 0.
  - 2 Close drain cock with key.
  - 3 Press cover locking button and screw cover on tight.
  - 4 Place water leak detector underneath the cleaner.
- NB:** Do not place water leak detector on metal surface or a damp floor.

## Installation

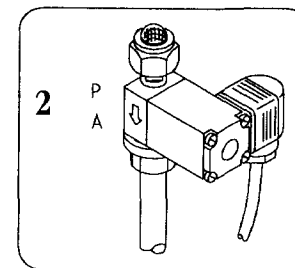
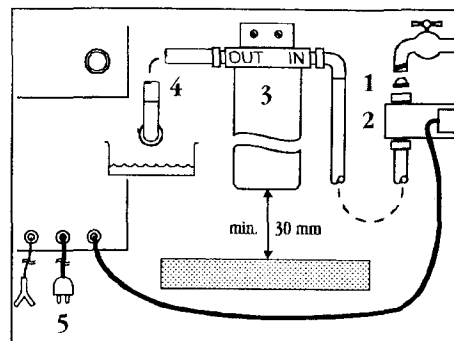

### Connecting to supply of tap water

- 1 Fit seal with strainer.
- 2 Connect Waterstop valve and hose tightly to **IN**.
- 3 Mount cartridge upright (leaving minimum floor clearance of 30 mm).
- 4 Fit hose to **OUT**. (Do not use metal pipe!)  
 Turn tap on and allow 2 or 3 litres of water to flow through. Then connect hose to Triton SLA.
- 5 Plug the cleaner in.

## Operation

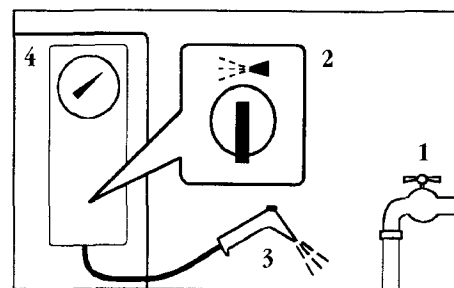

- 1 Turn tap on.
- 2 Turn switch to :
  - boiler is filled with water (takes about 3 minutes, when finished "max" indicator light comes on)
  - water is heated up ( comes on while heating).
- 3 **After about 15 minutes:**  
 Hold steam gun in a sink and hold trigger depressed until the steam is emitted evenly.
- 4 The cleaner is ready for operation when the reading on the pressure gauge is about 3 bar.

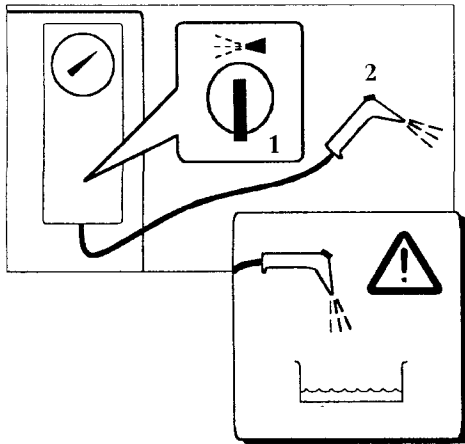

### Cleaning with dry steam

- 1 Turn switch to .
- 2 Use steam gun.

#### CAUTION - RISK OF SCALDING!

Before starting work hold the steam gun in the sink and hold trigger depressed until the steam is being emitted evenly.

Hold gun 2 to 3 cm away from the object.

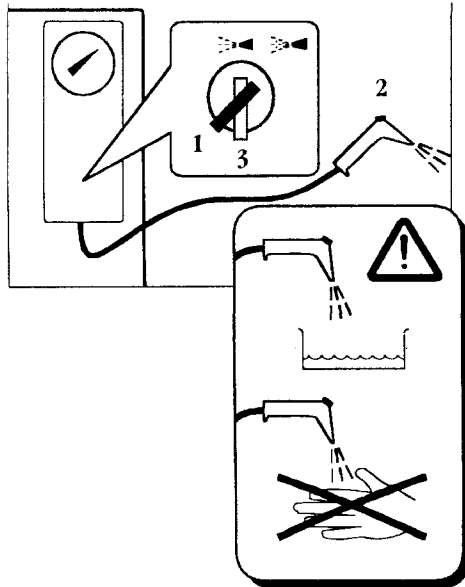

### Cleaning with wet steam

- 1 Turn switch to .
- 2 Use steam gun.

#### CAUTION - RISK OF SCALDING!

Before starting work hold the steam gun in the sink and hold trigger depressed until the steam is being emitted evenly. **Never hold the object to be cleaned with your fingers!**

Hold gun 5 to 10 cm away from the object.

- 3 Turn switch to  :  
Water is topped up until the "max." indicator light comes on.

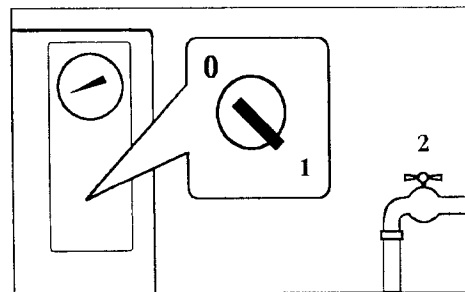



### Switching off (at the end of the working day)

- 1 Turn switch to 0.
- 2 Turn tap off.

## Care and maintenance

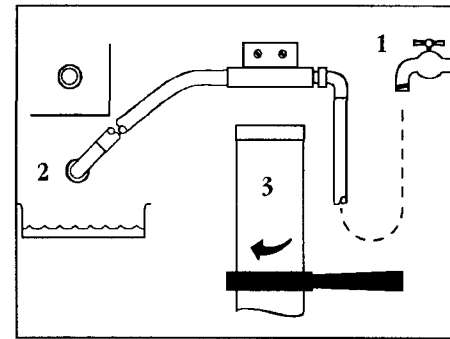
### Replacing the cartridge insert



 **Switch steam cleaner off and allow pressure to drop to zero:**  
Pressure gauge indicates 0 bar or less.

- 1 Turn tap off.
- 2 Unscrew hose and allow water to drain.
- 3 Unscrew casing with ring spanner.

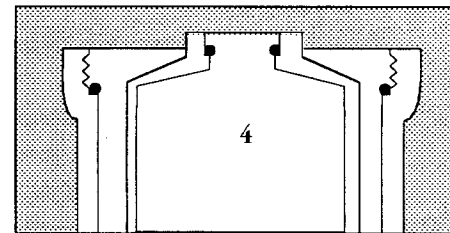

- 4 Replace insert.  
**Ensure the seals are correctly positioned!**

2 new inserts ..... Order No. 37602  
2 replacement inserts ..... Order No. 37602 T

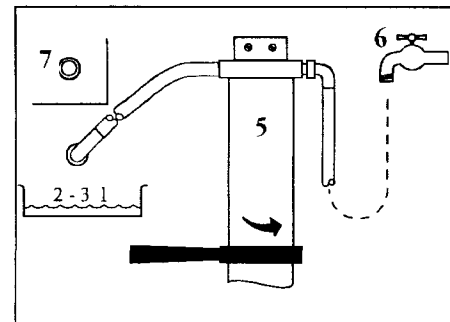

- 5 Screw casing tight with ring spanner.
- 6 Turn tap on,  
allow 2 or 3 litres of water to flow through,  
and turn it off again.
- 7 Screw hose on again tightly.

## Refilling insert

You can also fill the inserts with Durox yourself if you want to: 6 litres of Durox replacement non-reusable resin ..... Order No. 52121

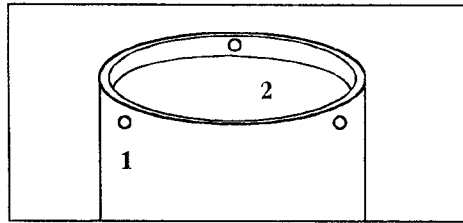

- 1 Pull rivets out.
- 2 Remove bottom section.

Dispose of spent resin in the same way as synthetic resin.

Wash insert thoroughly under running water.

Pour in about 2.3 l of Durox replacement resin and compact by placing on a vibrator. Fill in Durox up to about 5 mm below the rivet-holes.

Replace bottom section with rivets.

Fit seal (see "Replacing insert") and store insert so that it is protected from dust until fitted.

**Attention!** There are different bottoms (see figure). To avoid damage when installing the inserts, do not interchange the bottoms!

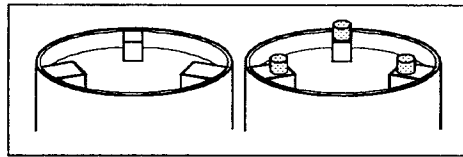

## Drain boiler

The emptying of the water out of the kettle can become necessary for the transport of the unit or for any other purposes.

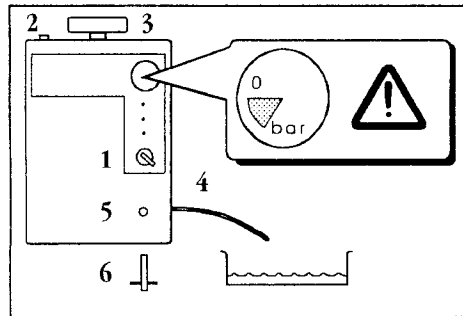

- 1 Turn switch to 0.

**Do not open the cleaner until the pressure has dropped to zero!** Ensure that the pressure gauge reads 0 bar or less before opening the cover or the drain cock.

- 2 Press cover locking button and
- 3 unscrew cover.
- 4 Lead hose into sink and
- 5 open drain cock with
- 6 key.

## Remedying faults

Fault	Cause	Remedy
Indicator lights do not come on even though main switch is turned on	No power	<ul style="list-style-type: none"> <li>▪ Plug cleaner in.</li> <li>▪ Check mains voltage.</li> <li>▪ Replace fuse.</li> </ul>
"µS" indicator comes on	Water leak detector responds	Water leak detector must be dry and must not lie on metal surface.
	Resin in cartridge insert spent	Replace insert (see "Care and maintenance")
Cleaner not heating up	No water	Turn tap on and/or
		<b>Switch temperature limiter on:</b> <ol style="list-style-type: none"> <li>1 Turn switch to 0.</li> <li>2 Unscrew dust cap, press temperature limiter with key 3, screw dust cap on again tightly.</li> </ol>
Gun losing steam	Valve leaking	Call after-sales service.
Cover leaking		Replace its seal.
Steam smells unpleasant	Resin in cartridge insert spent	Replace insert (see "Care and maintenance")

# Wichtige Hinweise zum Entkalken

Bei erschöpfter BEGO-Vollentsalzungspatrone gelangen geringe Salzengen in Triton SLA und führen auf Dauer zur Verkalkung. Deshalb Triton SLA regelmäßig entkalken: bei durchschnittlicher Wasserhärte alle 6 Monate, bei hoher Wasserhärte häufiger! **Verkalkungsschäden sind nicht von der Garantie gedeckt!**

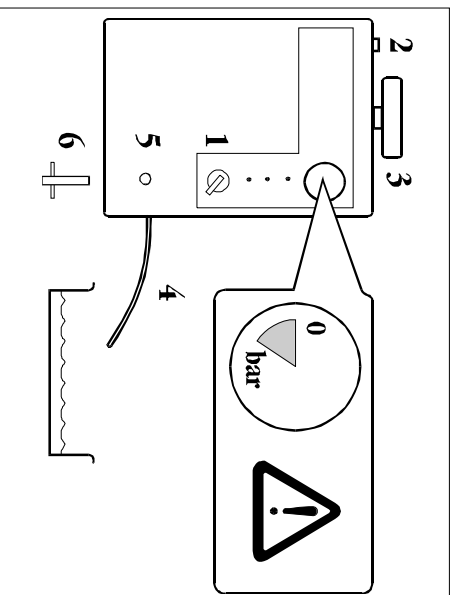

## Kessel entleeren

- Schalter auf **0** stellen.



### Nur druckloses Gerät öffnen!

Vor dem Öffnen des Deckels oder des Entleerungsahnes vergewissern, daß das Manometer 0 bar oder weniger anzeigt.

- Entriegelung drücken und
- Deckel abschrauben.
- Schlauch in Waschbecken führen.
- Hahn mit
- Schlüssel öffnen.

## Entkalker auffüllen

Nur Calex verwenden, da andere Entkalker Rückstände hinterlassen können! (Best.-Nr. 52 125)

Nach dem Entleeren:

- Hahn schließen.
- 250 ml Calex einfüllen (Trichter verwenden). **Deckel vom Gerät offen lassen.**
- Schalter auf **1** stellen.

**Wichtig:** Sofort wenn die Anzeige **WW** leuchtet,

Schalter auf **0** stellen (Wasserzulauf wird gestoppt; Wasser wird aufgeheizt)!

Nach ca. 10 Minuten Aufheizen Schalter auf 0 stellen!  
**Calex ca. 12 Stunden einwirken lassen.**

### Achtung: Gefahr des Überkochens!

- Wasserzulauf sofort beenden, wenn Anzeige **WW** leuchtet.
- Während des Heizens beim Gerät bleiben und Schalter sofort auf 0 stellen, wenn das Wasser vor Ablauf der 10 Minuten Heizzeit kochen sollte.

### Überkochen schädigt das Gerät!

- Hahn öffnen. Wasser ablaufen lassen.

## Kessel spülen und schließen

- Hahn schließen.
- Schalter auf **1** stellen, warten, bis Anzeige "max." leuchtet, Schalter auf **0** stellen.
- Hahn öffnen, Wasser ablaufen lassen. Hahn schließen.
- Deckelfestschrauben.

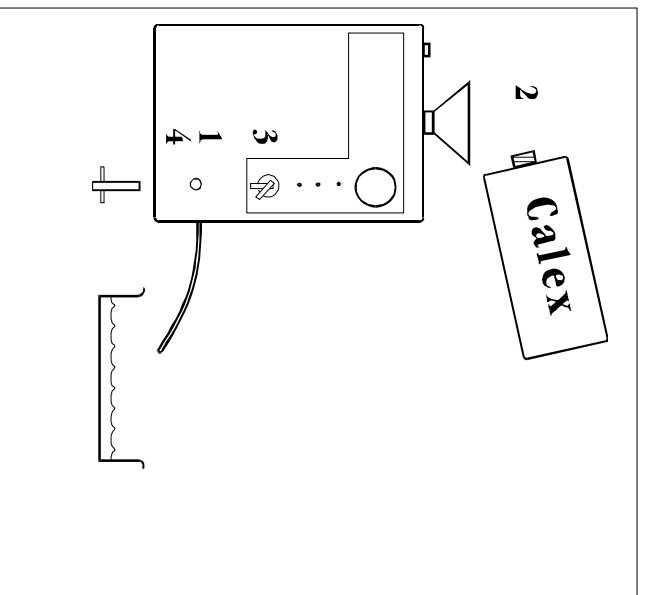
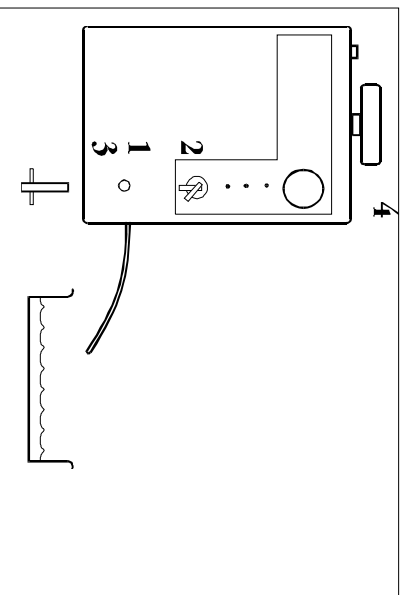

# Important remarks on decalcification

When the BEGO demineralization cartridge is exhausted, small quantities of salt penetrate into Triton SIA and after a time this leads to a decalcification. Therefore decalcify Triton SIA regularly; when having a normal water hardness decalcification should be carried out all six months, when having a high water hardness more often. **Damage caused by calcification is not covered by the guarantee.**

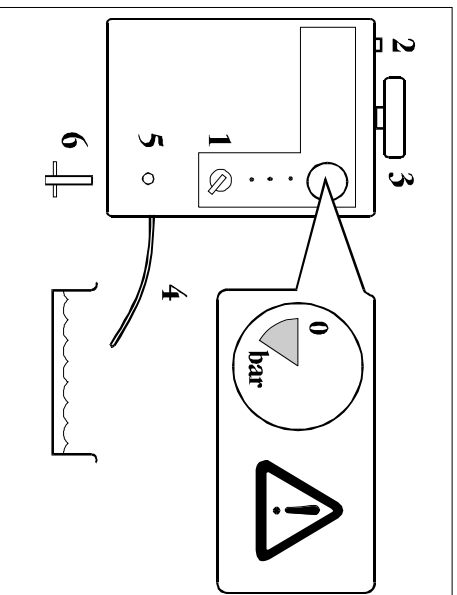

## Discharging boiler

- 1 Set switch to 0 position.

**Only open device when depressurized!**  
 Before opening the cover or the discharge cock valve, make sure the pressure gauge indicates 0 bar or less.

- 2 Press relief and
- 3 unscrew cover.
- 4 Place hose in water basing and
- 5 open cock valve
- 6 with key.

## Filling with decalcifying agent

Only use Calnex since other decalcifying agents may leave residues! (Order no. 52 125)

After discharging:

- 1 Shut off cock valve.
- 2 Fill with 250 ml Calnex (use funnel).

**Let the cover of the unit open.**

- 3 Set switch to .  
**Important:** Immediately after indicator lights up, set switch to (water intake is stopped, water is heating up)!

After approx. 10 minutes heating up, set switch to 0 position!  
**Allow Calnex to react for approx. 12 hours.**

**Attention: danger of boiling over!**

- Stop immediately the water intake, if the indicator lights up.
- During the heating up please do not leave the unit. If the water starts to boil in less than 10 minutes heating time, set switch immediately to 0 position.

**Boiling over damages the unit!**

- 4 Open cock valve, allow water to drain off.

## Flush boiler and close off

- 1 Shut off cock valve.
- 2 Set switch to , wait until "max." indicator lights up, set switch to 0 position.
- 3 Open cock valve, allow water to drain off.
- 4 Shut off cock valve.  
 Firmly secure cover.

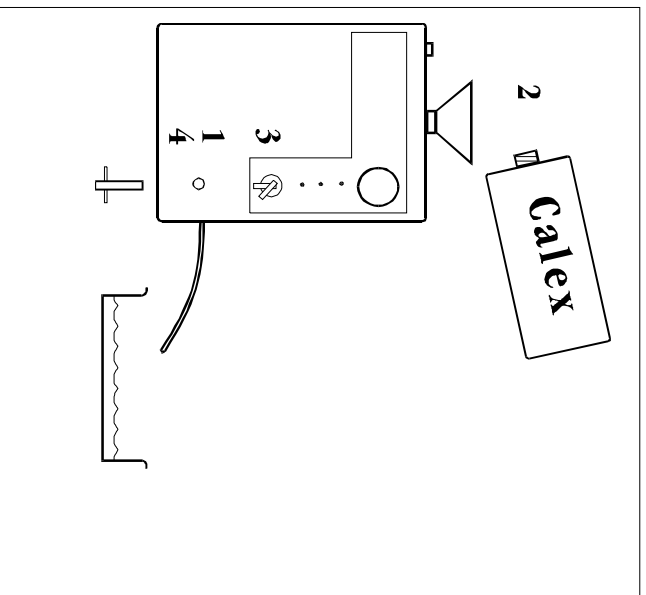
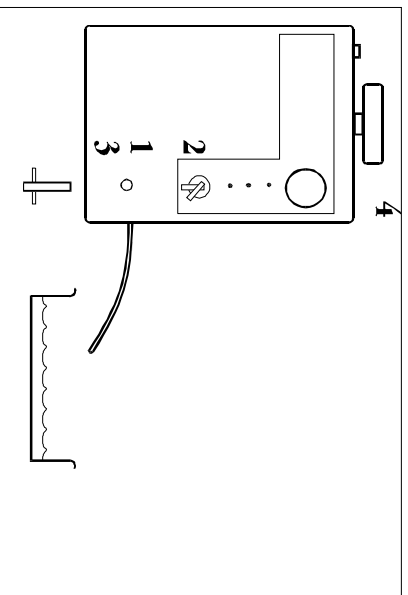



# Indications importantes pour le détartrage

Si la cartouche de déminéralisation totale BEGO est épuisée les petites quantités de sel arrivent au Triton SIA et mènent à la longue à une décalcification. Pour cette raison détartrer régulièrement le Triton SIA: pour une dureté de l'eau moyenne tous les six mois, pour une haute dureté de l'eau plus souvent! **Les dégâts par entartrage ne sont pas couverts par la garantie!**

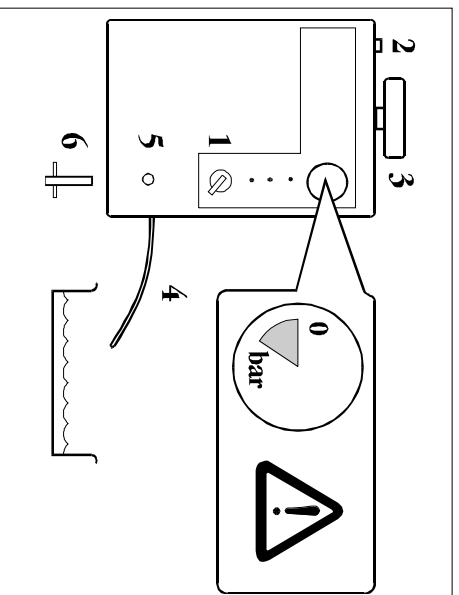

## Vidanger le récipient

- 1 Placer le commutateur sur "0".

**N'ouvrir le récipient que s'il n'est pas sous pression!**  
Avant d'ouvrir le couvercle ou le robinet de vidange, s'assurer que le manomètre indique 0 bar ou moins.

- 2 Enfoncer le déverrouillage et
- 3 dévisser le couvercle.
- 4 Amener le tuyau dans l'évier et
- 5 ouvrir le robinet
- 6 avec clé.

## Remplir le détartrateur

N'utiliser que du Calnex, car d'autres produits de détartrage peuvent laisser des résidus! (N° de cde 52 125)

Après avoir vidé:

- 1 Fermer le robinet.
- 2 Remplir avec 250 ml de Calnex (utiliser un entonnoir).  
**Laisser ouvert le couvercle de l'appareil.**
- 3 Placer l'interrupteur sur .

**Important:** Immédiatement quand l'indication luit , mettre le commutateur à

(La venue d'eau est arrêtée; l'eau est chauffée)!

Après avoir chauffé environ 10 minutes, mettre le commutateur à 0! **Faire agir Calnex pour environ 12 heures!**

### Attention: Danger de déborder en bouillonnant!

- Terminer immédiatement la venue d'eau quand l'indication luit .
- Rester à l'appareil pendant le chauffage et mettre le commutateur immédiatement à 0, si l'eau devrait bouillir avant le temps de chauffage de 10 minutes est atteint.

### Déborder en bouillant nuit l'appareil!

- 4 Ouvrir le robinet, laisser s'écouler l'eau.

## Rincer le récipient et le fermer

- 1 Fermer le robinet.
- 2 Placer le commutateur sur , attendre jusqu'à ce que l'affichage "max." s'allume, placer le commutateur sur 0.
- 3 Ouvrir le robinet, laisser s'écouler l'eau.  
Fermer le robinet.
- 4 Revisser le couvercle fermement.

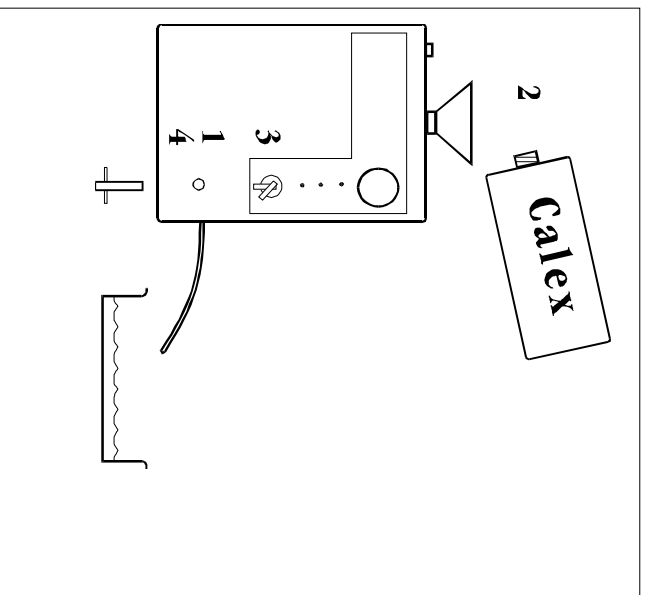
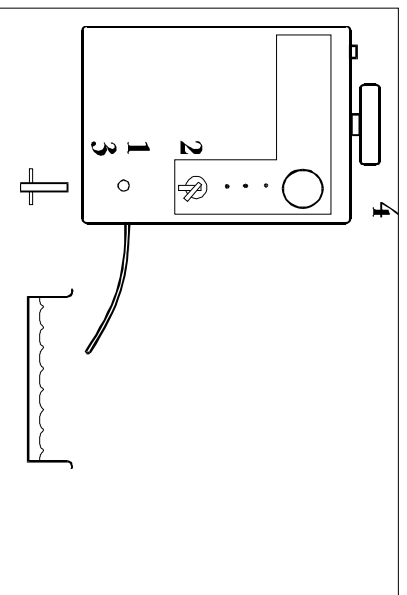

# Instrucciones importantes para la descalcificación

Cuando el cartucho de desalinización completa BEGO se agota, pequeñas cantidades de sal llegan al Triton SIA y a la larga, provocan la calcificación. Esto obliga a descalcificar el Triton SIA periódicamente: si el agua es de dureza media, cada 6 meses, y si es muy dura, con mayor frecuencia. **La garantía no cubre los daños por calcificación!**

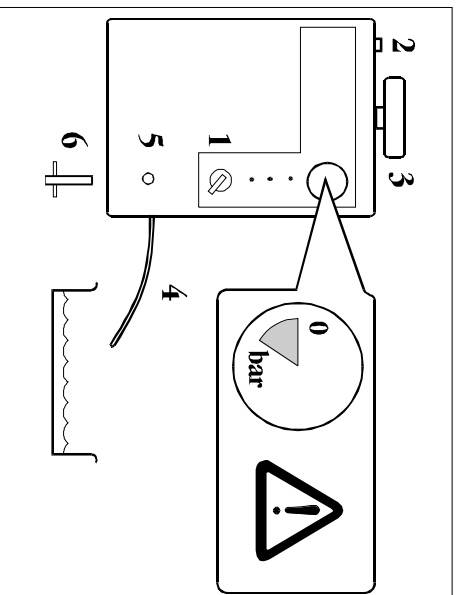

## Vaciar el calderín

- 1 Poner a **0** el conmutador.

**¡Solo se abrirá el aparato carente de presión!**  
Antes de abrir la tapa o la espita de vaciado hay que cerciorarse de que el manómetro indica 0 bar o menos todavía.

- 2 Pulsar el desbloqueo y
- 3 desatornillar la tapa.
- 4 Llevar el tubo al lavabo y
- 5 abrir el grifo
- 6 con la llave.

## Rellenar el desalinizador

Sólo se empleará Calnex puesto que otros descalcificadores pueden dejar residuos! (Ref. No. 52 125)

Después de vaciar el aparato:

- 1 Cerrar la espita.
- 2 Llenar con 250 ml de Calnex (emplear embudo).
- 3 **Mantener la tapa del aparato abierta.**  
Poner el conmutador en .  
**¡Importante!** Cuando se ilumine el display , colocar inmediatamente el interruptor en la posición . (La entrada de agua se interrumpe y el agua se calienta!)

Tras 10 minutos de calentamiento, colocar el interruptor en la posición 0.

**Dejar accionar Calnex aprox. 12 horas!**

### Atención:

**¡Existe el peligro de que el agua rebose al hervir!**

- Interrumpir inmediatamente la entrada de agua cuando se ilumine .
- Mientras se calienta el agua, vigile el aparato y coloque inmediatamente el interruptor en 0 si el agua empieza a hervir antes de que hayan transcurrido los 10 minutos.

**¡Si el agua rebosa dañará el aparato!**

- 4 Abrir el grifo, dejar evacuar agua.

## Enjuagar el calderín y cerrarlo

- 1 Cerrar la espita.
- 2 Poner el conmutador en , esperar hasta que luzca la indicación “**máx.**”, poner en “0” el conmutador.
- 3 Abrir la espita, dejar evacuar agua, cerrar la espita.
- 4 Aatornillar firmemente la tapa.

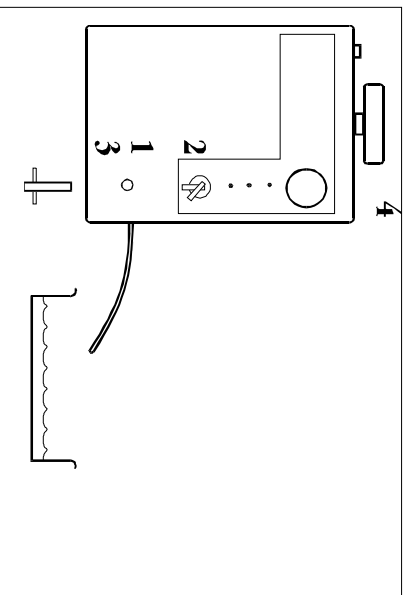
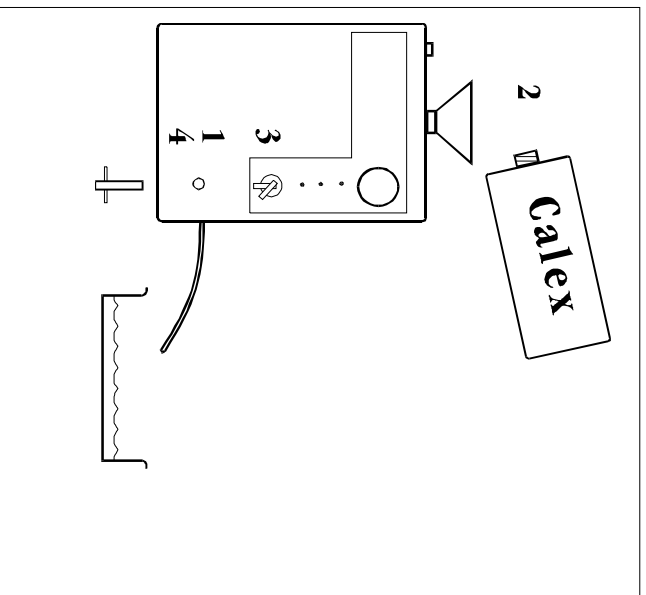

# Wasserwächter

## Water detector / Appareil de contrôle d'eau / Vigía del agua

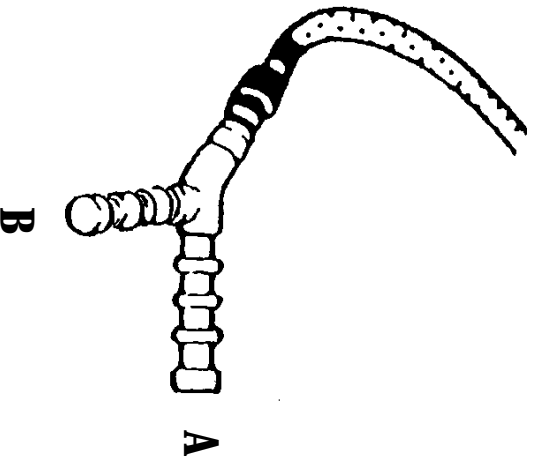

Der Wasserwächter schützt vor Wasserschäden.  
Wenn die Pole A und B durch Wasser (oder Metall) verbunden sind, wird das Wasserstop-Ventil am Zulaufschlauch geschlossen und die Anzeige µS am Gerät leuchtet.

Deshalb den Wasserwächter an eine trockene Stelle unter das Gerät legen - aber nicht auf Metall.

The water control protects against water damages.  
When the poles A and B are connected by water (or metal), the water-stop valve is closed at the water supply hose and the indicator µS is on at the unit.

Therefore place the water detector on a dry place underneath the unit - but not on metal.

L'appareil de contrôle d'eau protège contre des dégâts causés par l'eau. Quand les pôles A et B sont connectés par eau (ou métal), la soupape pour arrêter l'eau est fermée à la conduite d'arrivée et l'indication µS est allumée à l'appareil.

Donc placer le contrôle d'eau sur une place sèche sous l'appareil - mais non pas sur métal.

El vigía del agua protege contra daños causados por el agua. La válvula de retención de agua en el tubo de alimentación se cierra y el indicador µS luce en el aparato si los polos A y B están unidos por agua (o metal).

Por tal motivo, el vigía del agua se ha de poner en un sitio seco por debajo del aparato - pero no sobre metal.



## Artisan Technology Group is your source for quality new and certified-used/pre-owned equipment

- FAST SHIPPING AND DELIVERY
- TENS OF THOUSANDS OF IN-STOCK ITEMS
- EQUIPMENT DEMOS
- HUNDREDS OF MANUFACTURERS SUPPORTED
- LEASING/MONTHLY RENTALS
- ITAR CERTIFIED SECURE ASSET SOLUTIONS

### SERVICE CENTER REPAIRS

Experienced engineers and technicians on staff at our full-service, in-house repair center

### *InstraView*<sup>SM</sup> REMOTE INSPECTION

Remotely inspect equipment before purchasing with our interactive website at [www.instraview.com](http://www.instraview.com) ↗

### WE BUY USED EQUIPMENT

Sell your excess, underutilized, and idle used equipment. We also offer credit for buy-backs and trade-ins. [www.artisanng.com/WeBuyEquipment](http://www.artisanng.com/WeBuyEquipment) ↗

### LOOKING FOR MORE INFORMATION?

Visit us on the web at [www.artisanng.com](http://www.artisanng.com) ↗ for more information on price quotations, drivers, technical specifications, manuals, and documentation

**Contact us:** (888) 88-SOURCE | [sales@artisanng.com](mailto:sales@artisanng.com) | [www.artisanng.com](http://www.artisanng.com)