



Artisan Technology Group is your source for quality new and certified-used/pre-owned equipment

- FAST SHIPPING AND DELIVERY
- TENS OF THOUSANDS OF IN-STOCK ITEMS
- EQUIPMENT DEMOS
- HUNDREDS OF MANUFACTURERS SUPPORTED
- LEASING/MONTHLY RENTALS
- ITAR CERTIFIED SECURE ASSET SOLUTIONS

SERVICE CENTER REPAIRS

Experienced engineers and technicians on staff at our full-service, in-house repair center

*InstraView*SM REMOTE INSPECTION

Remotely inspect equipment before purchasing with our interactive website at www.instraview.com ↗

WE BUY USED EQUIPMENT

Sell your excess, underutilized, and idle used equipment. We also offer credit for buy-backs and trade-ins. www.artisanng.com/WeBuyEquipment ↗

LOOKING FOR MORE INFORMATION?

Visit us on the web at www.artisanng.com ↗ for more information on price quotations, drivers, technical specifications, manuals, and documentation

Contact us: (888) 88-SOURCE | sales@artisanng.com | www.artisanng.com



Gene Pulser[®] II Electroporation System

Instruction Manual

**Catalog Numbers
165-2105, 165-2106,
165-2107, 165-2108,
165-2109, 165-2110**



For Technical Service Call Your Local Bio-Rad Office or in the U.S. Call **1-800-4BIORAD** (1-800-424-6723)



Bio-Rad Laboratories

Life Science Group

2000 Alfred Nobel Drive
Hercules, California 94547
Telephone (510) 741-1000
Fax: (510) 741-5800
www.bio-rad.com

Australia, Bio-Rad Laboratories Pty. Ltd., Block Y, Unit 1, Regents Park Industrial Estate, 391 Park Road, Regents Park, NSW 2143
Phone 02 9914 2800 • Fax 02 9914 2889

Austria, Bio-Rad Laboratories Ges.m.b.H., Auhofstraße 78D, A-1130 Wien • Phone (01)-877 89 01 • Fax (01)-876 56 29

Belgium, Bio-Rad Laboratories S.A.-N.V., Begoniastraat 5, B-9810 Nazareth • Phone 09-385 55 11 • Free Phone 0800/97032 • Fax 09-385 65 54

Brazil, Bio-Rad Laboratories (Brazil), Rua dos Invalidos 212 - 5 andar, Lapa - Rio de Janeiro - RJ, CEP 20331-020 • Phone 55 21 507 6191

Canada, Bio-Rad Laboratories (Canada) Ltd., 5671 McAdam Road, Mississauga, Ontario L4Z 1N9 • Phone (905) 712-2771 • Fax (905) 712-2990

China, Bio-Rad China (Beijing), Rm 615, Shang Fang Plaza, No. 27, North Third Round Center Road, West District, Beijing 100029
Phone 86-10-8201-1366/68 • Fax 86-10-8201-1367

Denmark, Bio-Rad Laboratories, Generatorvej 8 C, 2730 Herlev • Phone 45 44 52-1000 • Fax 45 44 52-1001

Finland, Bio-Rad Laboratories, Pihatorma 1A, FIN-02240 Espoo • Phone 358 (0)9 804 2200 • Fax 358 (0)9 804 1110

France, Bio-Rad Laboratories, 3, Boulevard Raymond Poincaré, 92430 Marnes-la-Coquette • Phone 01 47 95 69 65 • Fax 01 47 41 9133

Germany, Bio-Rad Laboratories GmbH, Heidemannstraße 164, D-80939 München, Postfach 45 01 33, D-80901 München
Phone 089 318 84-177 • Fax 089 318 84-123

Hong Kong, Bio-Rad Pacific Ltd., Unit 1111, 11/F, New Kowloon Plaza, 38 Tai Kok Tsui Road, Tai Kok Tsui, Kowloon
Phone 852-2789-3300 • Fax 852-2789-1257

India, Bio-Rad Laboratories (India) Pvt. Ltd., B&B1, Enkay Towers Vanijyanikunj, Udhog Vihar Phase V, Gurgaon, Haryana 122016
Phone (91-124)-6398112/113/114 • Fax (91-124)-6398115

Israel, Bio-Rad Laboratories, Ltd., 14 Homa Street, P.O. Box 5044, Rishon Le Zion 75150 • Phone 03 951 4124 • Fax 03 951 4129

Italy, Bio-Rad Laboratories S.r.l., Via M. Peroglio 23, 00144 Rome • Phone 34 91 590 5200 • Fax 34 91 590 5211

Japan, Nippon Bio-Rad Laboratories KK, 7-18 Higashi-Nippori 5-chome, Arakawa-ku Tokyo 116-0014 • Phone 03-5811-6270 • Fax 03-5811-6272

Korea, Bio-Rad Korea Ltd., Cambridge Building, 1461-15 Seocho-Dong Seocho-Ku, Seoul 137-070 • Phone 82-2-3473-4460 • Fax 82-2-3472-7003

Latin America, Bio-Rad Latin America, 14100 Palmetto Frontage Road, Suite 101, Miami Lakes, Florida USA 33016 • Phone 305-894-5950 • Fax 305-894-5960

Mexico, Bio-Rad Laboratorios Mexico, Adolfo Prieto No. 1653, Col. De Valle, CP. 03100, Mexico D.F. • Phone 52 5 534 2552 to 54 • Fax 52 5 524 5971

The Netherlands, Bio-Rad Laboratories B.V., Fokkerstraat 10, 3905 KV Veenendaal • Phone 0318-540666 • Fax 0318-542216

New Zealand, Bio-Rad Laboratories Pty Ltd., PO Box 300-571, Albany, Auckland • Phone 64-9-4152280 • Fax 64-9-443 3097

Norway, Bio-Rad Laboratories, Johan Scharffenbergs vei 91, N-0694 Oslo • Phone 47-23-38-41-30 • Fax 47-23-38-41-39

Russia, Bio-Rad Laboratorii, ul. Butirskaya 79 "B", office 156 RF-125015 Moscow • Phone 7 095 979 98 00 • Fax 7 095 979 98 56

Singapore, Bio-Rad Laboratories, Singapore, 211 Henderson Rd. #03-02, Henderson Industrial Park, 159552 • Phone 65-2729877 • Fax 65-2734835

Spain, Bio-Rad Laboratories S.A., Lopez de Hoyos, 245-247, 28043 Madrid • Phone 34-91-590-5200 • Fax 34-91-590-5211

Sweden, Bio-Rad Laboratories AB, Vintergatan 1, Box 1097, S-172 22 Sundbyberg • Phone 46 (0)8-55 51 27 00 • Fax 46 (0)8-55 51 27 80

Switzerland, Bio-Rad Laboratories AG, Nenzlingerweg 2, CH-4153 Reinach • Phone 061-717-9555 • Fax 061-717-9550

United Kingdom, Bio-Rad Laboratories Ltd., Bio-Rad House, Maylands Avenue, Hemel Hempstead, Hertfordshire HP2 7TD

Phone 0181 328 2000 • Free Phone 0800-181134 • Fax 01442-259118

0000 Sig 1200

M1652105 Rev C

Warranty

The Gene Pulser II electroporation system is warranted against defects in materials and workmanship for 1 year. If any defects occur in the instruments or accessories during this warranty period, Bio-Rad Laboratories will repair or replace the defective parts at its discretion without charge. The following defects, however, are specifically excluded:

1. Defects caused by improper operation.
2. Repair or modification done by anyone other than Bio-Rad Laboratories or an authorized agent.
3. Damage caused by substituting alternative parts.
4. Use of fittings or spare parts supplied by anyone other than Bio-Rad Laboratories.
5. Damage caused by accident or misuse.
6. Damage caused by disaster.
7. Corrosion caused by improper solvent or sample.

This warranty does not apply to parts listed below:

Fuses

For any inquiry or request for repair service, contact Bio-Rad Laboratories. Inform Bio-Rad of the model and serial number of your instrument.

IMPORTANT: This Bio-Rad instrument is designed and certified to meet IEC 1010-1* safety standards. Certified products are safe to use when operated in accordance with the instruction manual. This instrument should not be modified or altered in any way. Alteration of this instrument will:

Void the manufacturer's warranty

Void the IEC 1010-1 safety certification

Create a potential safety hazard

Bio-Rad Laboratories is not responsible for any injury or damage caused by the use of this instrument for purposes other than those for which it is intended, or by modifications of the instrument not performed by Bio-Rad Laboratories or an authorized agent.

*IEC 1010-1 is an internationally accepted electrical safety standard for laboratory instruments.

Table of Contents

	Page
Section 1 Introduction	1
1.1 Gene Pulsar II System Description	1
Section 2 Unpacking and System Installation.....	2
2.1 Safety	2
2.2 Unpacking The System Components.....	3
2.3 Setting Up The System.....	3
Section 3 Guide to Switches and Keypads.....	7
3.1 Gene Pulsar II Unit Control Panel	8
3.2 Pulse Controller II Front Panel	13
3.3 Pulse Controller PLUS Front Panel	14
3.4 Capacitance Extender II Front Panel	15
3.5 Capacitance Extender PLUS Front Panel	16
Section 4 Operation.....	16
4.1 Instructions for Using the Gene Pulsar II unit and the Pulse Controller II (or PLUS) Accessory	16
4.2 Instructions for Using the Gene Pulsar II unit with the Capacitance Extender II (or PLUS) Accessory Module	17
Section 5 The Pulse Trac™ system.....	18
5.1 Pulse Trac System Description	18
5.2 Pulse Trac Diagnostic Algorithm.....	18
Section 6 Instrument Diagnostics and Troubleshooting	20
Section 7 Specifications and Product Information	21
7.1 System Specifications	21
7.2 Product Information	22
Appendix A Review of Electroporation Fundamentals	22

Section 1

Introduction

This manual will familiarize you with the features and the operation of the Gene Pulser II apparatus with its accessory components, the Pulse Controller II or Pulse Controller PLUS module and the Capacitance Extender II or Capacitance Extender PLUS module.

Section 2, Unpacking and System Installation, contains important safety information as well as instructions on unpacking and connecting the Gene Pulser instrument to the Pulse Controller II or Pulse Controller PLUS module and the Capacitance Extender II or Capacitance Extender PLUS module for electroporation.

Use Section 3, Guide to Switches and Keypads, to learn about the controls and read-out information that the Gene Pulser II apparatus provides with the Pulse Controller II or Pulse Controller PLUS module and Capacitance Extender II or Capacitance Extender PLUS module.

In Section 4, Operation, you can examine basic set up and protocols for both prokaryotic and eukaryotic electroporation.

1.1 Gene Pulser II System Description

The new Gene Pulser II system* is a completely redesigned electroporation system, which offers improved performance, flexibility, sample protection, and safety. The Gene Pulser II system uses the Pulse Trac™ waveform delivery system to generate the most accurate exponential decay pulses possible for optimal cell transformation within an electroporation cuvette. The Pulse Trac delivery system accurately calculates the time constant of each pulse based on what is actually delivered to the sample. The revolutionary Pulse Trac waveform delivery system provides

- Sample conductivity measurement integrated with pulse output for true waveform delivery regardless of sample
- Internal calibration and circuit monitoring program for accurate pulse delivery throughout the lifetime of the unit
- Improved time constant accuracy

Other features of the new Gene Pulser II system include

- Error free assembly, since each module uses unique cable connectors, keyed to fit only in the proper orientation and location
- Automatic display of time constant after every pulse, to make it easier to record this essential pulse parameter
- Easier optimization of novel prokaryotic applications with a wider range of high voltage capacitors (1.0 , 3.0, 10, 25, and 50 μF) in the Gene Pulser II unit
- Pinpointing of optimal field strengths, with voltage selection in 2 V increments for mammalian cell electroporation (low voltage/high capacitance) and operation at a higher maximum voltage (up to 500 V). In addition, voltage selection in 10 V increments for bacterial (high voltage/low capacitance) electroporation
- Increased control of high voltage pulses used for bacteria and yeast electro-transformation with the five new resistors in the Pulse Controller PLUS module

* United States Patent numbers 4,750,100; 4,910,149 and patents in application.

- Expanded range of precision capacitors for reproducible mammalian cell electroporation; 25 μF –3,275 μF with the Capacitance Extender PLUS module or 25 μF –1,075 μF with the Capacitance Extender II module. This permits greater time constant reproducibility and flexibility with electronically calibrated capacitors in 25 μF increments. At any time, the Pulse Trac circuitry can verify and calibrate these capacitors within $\pm 10\%$ variation for the ultimate in pulse reproducibility and precision.
- Designed and certified to meet IEC 1010 safety standards
- Entire system is completely protected from sample arcs, regardless of module or sample used
- Expanded safety, with charges automatically diverted safely to ground whenever the circuit is interrupted during pulse delivery.

The Gene Pulser II unit may be used with either of two new types of accessory modules. For electroporation of bacteria and yeast, use the Pulse Controller II or Pulse Controller PLUS module. For electroporation of mammalian cells and embryonic tissue, use the Capacitance Extender II or Capacitance Extender PLUS module.

Section 2 Unpacking and System Installation

Read this important information before you use the Gene Pulser II electroporation device with the Pulse Controller II or Pulse Controller PLUS module and the Capacitance Extender II or Capacitance Extender PLUS module.

2.1 Safety

This instrument is intended for laboratory use only.

This product conforms to the “Class A” standards for electromagnetic emissions intended for laboratory equipment applications. It is possible that emissions from this product may interfere with some sensitive appliances when placed nearby or in the same circuit as those appliances. The user should be aware of this potential and take appropriate measures to avoid interference.

No part of the Gene Pulser II system should be used if obvious external case damage has occurred or the electronic displays are not functioning as described in the manual. This instrument is only to be used with the components provided (or their authorized additions or replacements) including, but not limited to, supplied cables and shocking chamber. The operating temperature range for the Gene Pulser II system and its associated components is 0–35 °C.

This Bio-Rad instrument is designed and certified to meet IEC 1010* safety standards. There are no user serviceable parts within the unit. The operator should make no attempt to open any case cover or defeat any safety interlock. This instrument must not be altered or modified in any way. Alteration of this instrument will

- Void the manufacturer’s warranty
- Void the IEC 1010 safety certification
- Create a potential safety hazard

Bio-Rad is not responsible for any injury or damage caused by the use of this instrument for purposes other than those for which it is intended or by modification of the instrument not performed by Bio-Rad or an authorized agent.

*IEC 1010 is an internationally accepted electrical safety standard for laboratory instruments.

2.2 Unpacking the System Components

Remove all packing material and connect components on a flat, dry surface near an appropriate electrical outlet.

The Gene Pulser II apparatus should arrive complete with the following components

- 1 Gene Pulser II unit
- 1 Gene Pulser II shocking chamber (clear plastic cover with attached red and black cables, base with attached leads, and cuvette holder)
- 1 Cuvette rack
- 5 0.1 cm cuvettes
- 5 0.2 cm cuvettes
- 5 0.4 cm cuvettes
- 1 Warranty card (please complete and return)

The Pulse Controller II or Pulse Controller PLUS accessory to the Gene Pulser II unit should arrive complete with the following components

- 1 Pulse Controller II or Pulse Controller PLUS module (with integrated leads)
- 1 Warranty card (please complete and return)

The Capacitance Extender II or Capacitance Extender PLUS accessory to the Gene Pulser II unit should arrive complete with the following components

- 1 Capacitance Extender II or Capacitance Extender PLUS module accessory (with integrated leads)
- 1 RS 232 readout cable (25 pin)
- 1 Warranty card (please complete and return)

2.3 Setting Up the System

Setting Up the Gene Pulser II Unit

To use the Gene Pulser II unit with either the Pulse Controller II or Pulse Controller PLUS and the Capacitance Extender II or Capacitance Extender PLUS, follow this procedure.

1. Verify Gene Pulser II unit voltage compatibility with local electrical output by checking that the red voltage switches in the back of the unit are in the proper position (Figure 2.1).
 - Units operating in the 110-120 V range must have the red voltage switches positioned so 115 V is visible on both switches.
 - Units operating in the 220-240 V range must have the red voltage switches positioned so 230 V is visible on both switches.
2. Attach the power cord to the three pronged receptacle on the back of the Gene Pulser II unit (Figure 2.1) and plug the unit into an appropriate electrical outlet or power strip.

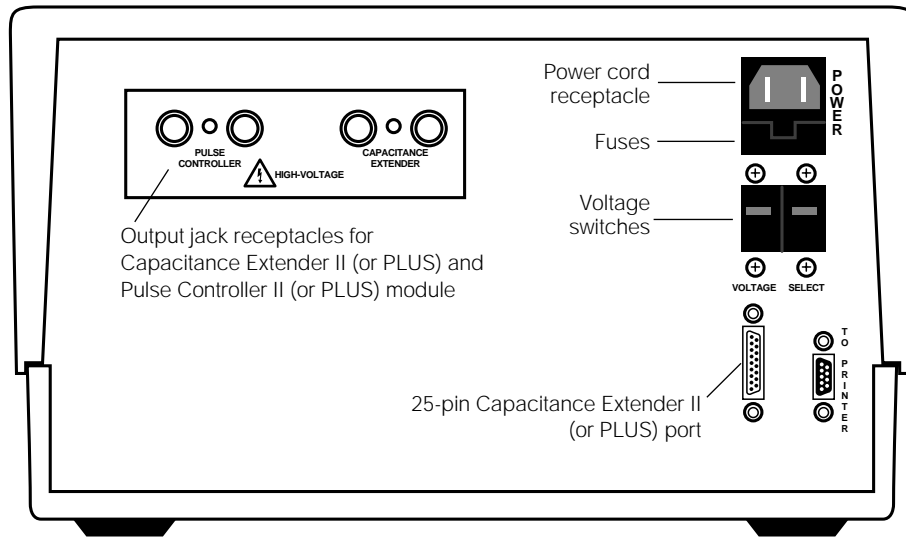

Fig. 2.1. Rear panel of Gene Pulser II unit. Voltage switches, cable ports, power cord, and output jack receptacles.

3. Assemble the shocking chamber by placing the clear plastic cover (end without cables) over the mid point of the base. Position the plastic cover so that base leads insert securely into the cable receptacles on the plastic cover. Insert the cuvette slide into base (Figure 2.2).

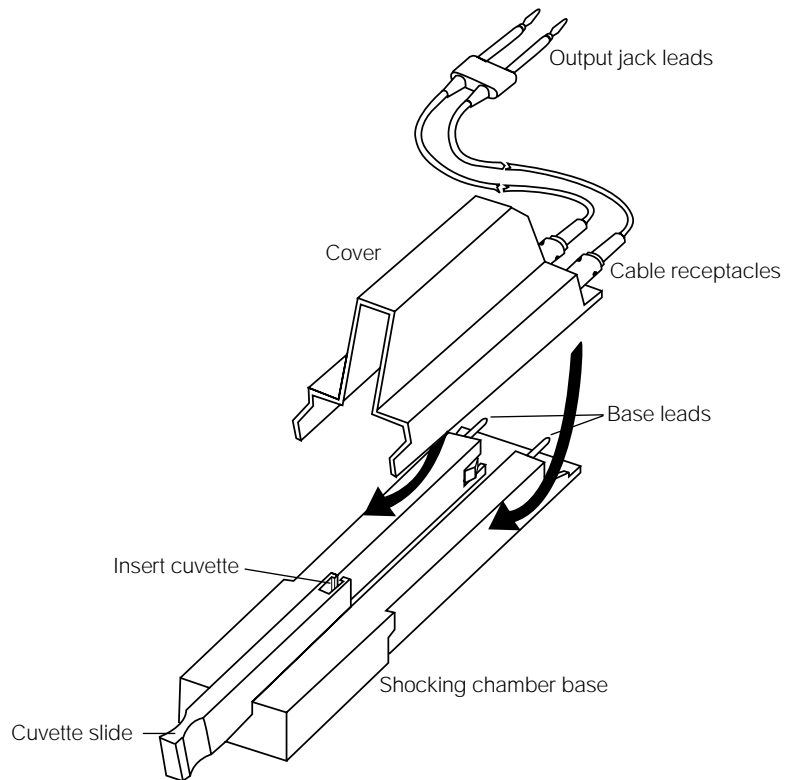

Fig. 2.2. Assembly of Gene Pulser II unit shocking chamber.

Connecting the Pulse Controller II or Pulse Controller PLUS Accessory to the Gene Pulser II Unit

1. Place the Pulse Controller II or (PLUS) module on top of or near the Gene Pulser II unit.
2. Insert the red/black leads that are permanently attached to the back of the Pulse Controller II (or Pulse Controller PLUS) into the appropriately labeled receptacle on the back of the Gene Pulser II unit. The leads are keyed so that they will insert only into the proper output jack in the correct red/black orientation.

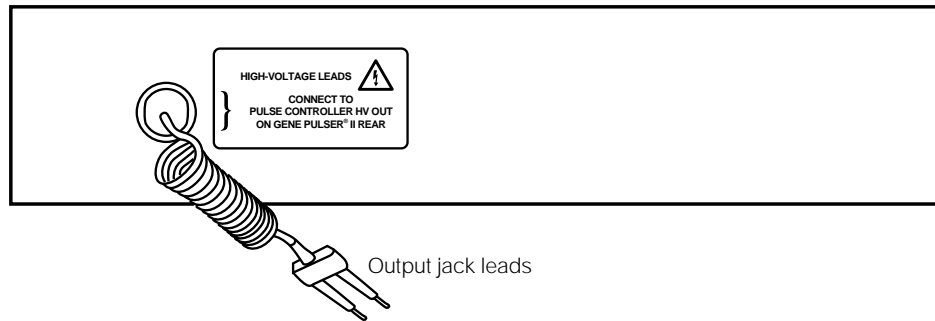

Fig. 2.3. Rear view (back panel) of Pulse Controller II (or PLUS) module.

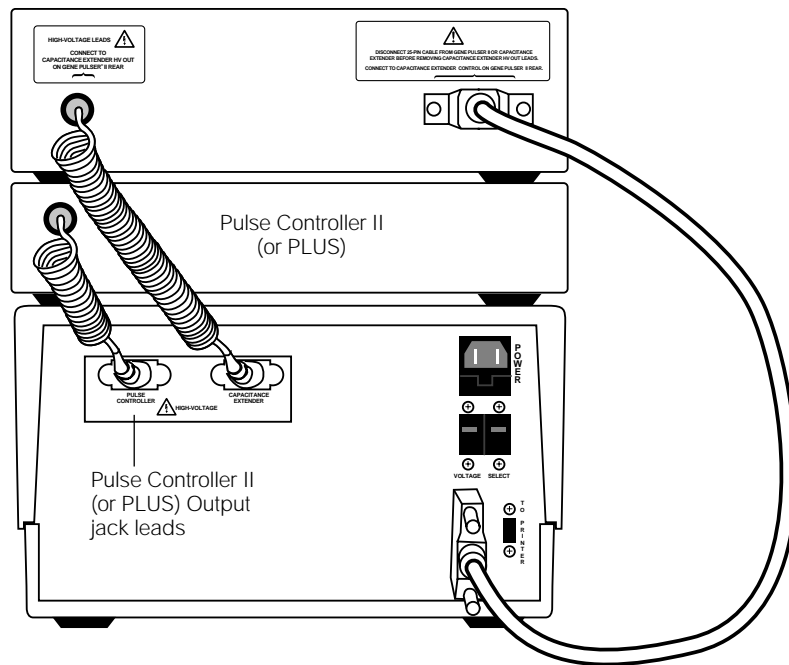

Fig. 2.4. Red/black leads (back panel) of Pulse Controller II (or PLUS) module, inserted into back panel of Gene Pulser II unit.

3. Connect the leads from the shocking chamber to the output jacks on the front of the Pulse Controller II (or PLUS) accessory module. The leads are keyed so that they will insert only in the correct red/black orientation.

Connecting the Capacitance Extender II or Capacitance Extender PLUS to the Gene Pulser II Unit

1. Place the Capacitance Extender II (or PLUS) on top of or near the Gene Pulser II unit. If the Pulse Controller II (or PLUS) module is also to be used, we recommend that you first place the Pulse Controller II (or PLUS) module on top of the Gene Pulser II unit and then place the Capacitance Extender II (or PLUS) module atop the Pulse Controller module.
2. Insert the red/black leads that are permanently attached to the back of the Capacitance Extender II (or PLUS) into the appropriately labeled receptacle on the back of the Gene Pulser II unit. The leads are keyed so that they will insert only into the proper output jack in the correct red/black orientation.
3. Complete the connection of the Capacitance Extender II (or PLUS) module to the Gene Pulser II unit using the supplied RS 232 cable (25 pin). (Figure 2.5 and 2.6).

Make certain that the power switch is off on the Gene Pulser II unit.

Insert one end of cable (the end with 25 pins inside) into the appropriate connecting port on back panel of Gene Pulser II unit. Secure cable to port with the two cable attachment screws-finger tighten with a clockwise motion.

Attach the other end of the cable into the 25 pin receptacle on the back of the Capacitance Extender II or Capacitance Extender PLUS unit. Secure cable to port with the two cable attachment screws-finger tighten with a clockwise motion.

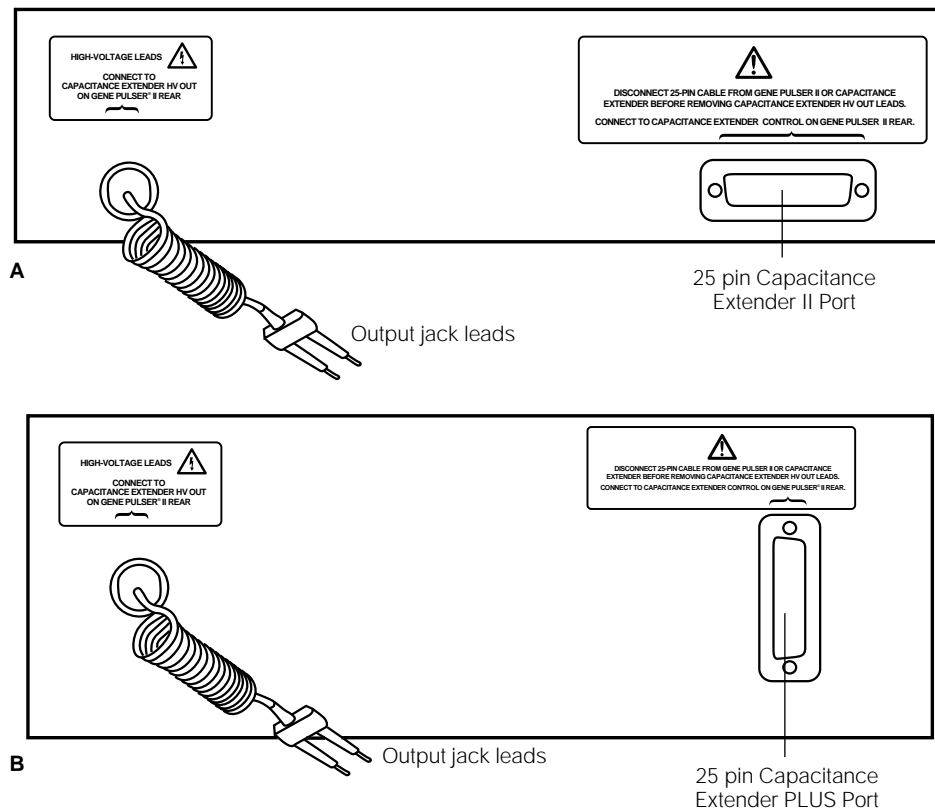

Fig. 2.5. Back panel of (A) Capacitance Extender II or (B) Capacitance Extender PLUS module.

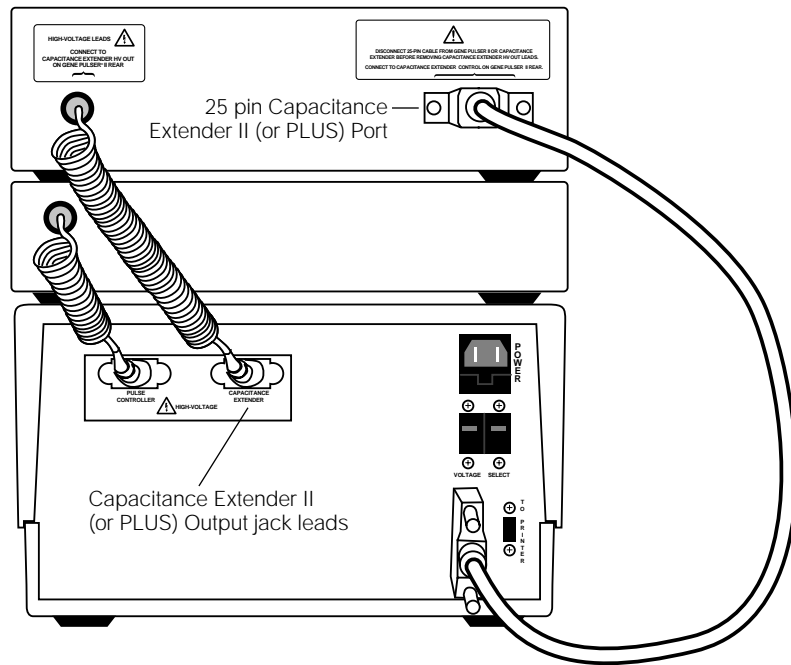

Fig. 2.6. Red/black leads and the 25 pin RS232 cable of the Capacitance Extender II (or PLUS) module (back panel) connected to the appropriate output jacks and port on the back panel of the Gene Pulser II unit.

4. When using the Capacitance Extender II (or PLUS) module, connect the leads from the shocking chamber to the output jacks on the front of the Gene Pulser II unit. The leads are keyed so that they will insert only in the correct red/black orientation.

Section 3 Guide to Switches and Keypads

Before operating the Gene Pulser II system with either the Pulse Controller II (or PLUS) or the Capacitance Extender II (or PLUS) accessory, it is helpful to understand the display information, switches, and keypad controls for these devices.

3.1 Gene Pulser II Unit Control Panel

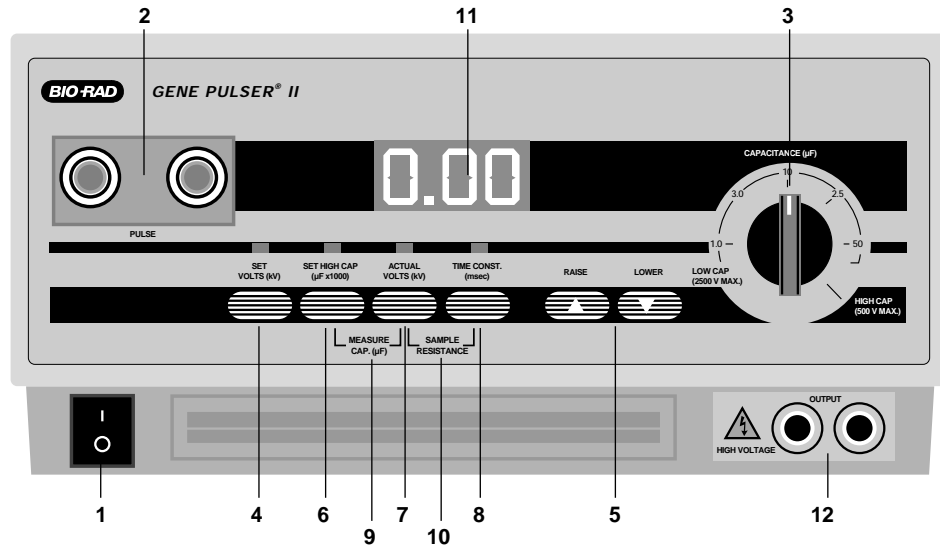
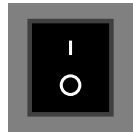
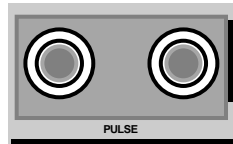

Fig. 3.1. The control panel of the Gene Pulser II apparatus. Front panel identification of switches and keypads for the Gene Pulser II unit. Note that the keypad(s) are active when the light(s) above them are illuminated.



1. POWER

Function	Result/Display
Turns unit on and off	With the power on, the system initializes in the Set Volts mode (the light above SET VOLTS will be illuminated).



2. PULSE

Function	Result/Display
Pressing both Pulse buttons continuously activates the Pulse Trac system to deliver the set voltage to the cuvette via the selected capacitor(s).	Capacitor selected is charged with set voltage, and CHg is displayed. Pulse is delivered to cuvette as tone sounds and PLS is displayed. Release the pulse buttons after the tone sounds. The time constant of the pulse is then automatically displayed.
If the two Measure Cap. keypads are selected, pressing both the Pulse buttons continuously activates the Pulse Trac system to measure the selected capacitor.	The Pulse Trac system is activated to measure the actual storage capacity of selected capacitor. No energy is delivered to the sample cuvette. (You can verify this, as the time constant for this Pulse mode is 0.00). See Measure Cap. key description below.

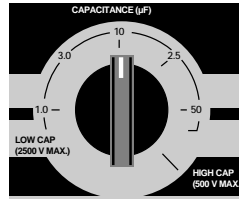

3. CAPACITANCE (μF) rotary switch

Function	Result/Display
<p>LOW CAP. (2,500 V max.). Positions 1.0, 3.0, 10, 25, or 50 μF select the specific high voltage/low value capacitor inside the Gene Pulser II unit.</p>	<p>Selecting any of the Low Cap. capacitors (used with the Pulse Controller II (or PLUS) module—high voltage) allows the Set Volts adjustment to range from 0.2 to 2.5 kV in 10 V (0.01 kV) increments.</p>
<p>HIGH CAP. (500 V max.) position activates low voltage circuitry for use of higher value capacitors in Capacitance Extender II or PLUS accessory module.</p>	<p>Selecting the High Cap. position on rotary Capacitance switch activates the Capacitance Extender II (or PLUS) module and allows the Set Volts adjustment to range from 0.050 to 0.500 kV (50 to 500 V) with 2 V (0.002 kV) increments.</p>

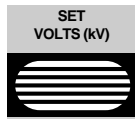

4. SET VOLTS



then 5. RAISE LOWER

Function	Result/Display
<p>Pressing SET VOLTS activates the Raise and Lower keypads that are used to adjust the desired voltage to be delivered to the sample cuvette.</p>	<ul style="list-style-type: none"> The Set Volts display is in kilovolts.
<p>To Set volts for High voltage/low capacitance Pulse Trac waveforms (using Pulse Controller II or PLUS module).</p>	<p>High voltage/low capacitance Pulse Trac waveforms:</p> <ul style="list-style-type: none"> The 3 digit LED display reads 0.00 when any of the Low Cap. (1, 3, 10, 25, or 50 μF) capacitors are selected for use in delivering high voltage. <p>The Set Volts adjustment ranges from 0.2 to 2.5 kV, in 10 volt (0.01 kV) increments when any of these high voltage capacitors are selected.</p> <ul style="list-style-type: none"> Pre-set high voltage settings used with the Pulse Controller II (or PLUS) module are available by pressing both the Raise and Lower keypads simultaneously. Pressing these two keys once will set the voltage to 1.8 kV (1.80 will be displayed). Pressing both the Raise and Lower keypads twice will set the voltage to 2.5 kV and 2.50 will be displayed. Pressing both buttons a third time will reset the voltage to 0.00 kV.

Function	Result/Display
To Set volts for Low voltage/high capacitance Pulse Trac waveforms (using Capacitance Extender II or PLUS module).	<p>Low voltage/high capacitance Pulse Trac waveforms:</p> <p>The 3 digit LED display reads .000 if the High Cap. position is selected.</p> <p>The Set Volts adjustment ranges from 0.050 to 0.500 kV (50 to 500 V) with 2 V (0.002 kV) increments when High Cap. position is selected on rotary Capacitance switch. [Note: If the voltage is set at 0.00, the display will read NO if the pulse buttons are pressed].</p> <p>Pre-set low voltage settings used with the Capacitance Extender II (or PLUS) module are available by pressing both the Raise and Lower keypads simultaneously. Pressing these two keys once will set the voltage to 0.360 kV (and 0.360 will be displayed). Pressing both the Raise and Lower keypads twice will set the voltage to 0.500 kV and .500 will be displayed. Pressing both buttons a third time will reset the voltage to .000 kV.</p>

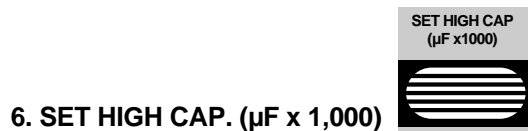

Function	Result/Display
Allows Raise and Lower keypads to adjust the selection of capacitors of the Capacitance Extender II (or PLUS) module.	<p>When the power is turned on, the capacitor selected is 0.025 (x 1,000) or 25 μF. The display reads .025.</p> <p>Adjustments can be made in 25 μF increments using the Raise or Lower buttons. Choose capacitors between 25 to 1,075 μF [displayed as .025 to 1.07 (x 1,000) μF] in the Capacitance Extender II module or 25 to 3,275 μF [displayed as .025 to 3.27 (x 1,000) μF] in the Capacitance Extender PLUS module.</p> <p>The LED abbreviates the display of capacitors larger than 975 μF as 1.00=1.000, 1.02 =1.025, 1.05 =1.050, 1.07 =1.075 (x 1,000) μF, etc., but actual capacitor values are as cited.</p> <p>Dashes (---) will appear on LED display if Capacitance rotary switch is not set on High Cap. position.</p> <p>If the Capacitance Extender II (or PLUS) module is not connected to the Gene Pulser II unit, NO will be displayed.</p>

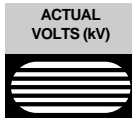

7. ACTUAL VOLTS (kV)

Function	Result/Display
After pulse, displays actual volts delivered to sample in cuvette using the Pulse Trac system.	The Actual Volts (kV) function displays the actual volts delivered to the cuvette. The value is retained until next pulse is delivered and power remains on. Raise and Lower keys cannot be used when the Actual Volts key is active.

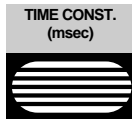

8. TIME CONST. (msec)

Function	Result/Display
Displays the actual measured time constant of the Pulse Trac waveform delivered by Gene Pulser II unit to the cuvette sample. The time constant (τ) is the amount of time required for the actual voltage of the delivered pulse to decrease to a value of $1/e$ of the true peak pulse. The display is in msec.	<p>The actual time constant is automatically displayed as a LED value after a pulse is delivered. This value is retained until next pulse is delivered and power remains ON.</p> <p>The time constant range for high voltage pulses with the Pulse Controller II (or PLUS) module is 0.02 to 80 msec with a 0.02 msec precision. The time constant range for low voltage pulses with the Capacitance Extender II (or PLUS) module is 0.1 msec to 6.5 sec.</p> <p>Time constants larger than 999 msec are displayed in abbreviated form. For example, 1,000 msec is displayed as 1.0t (or 1 x 1,000 msec).</p> <p>Raise and Lower keys cannot be used when the Time Const. key is active.</p>

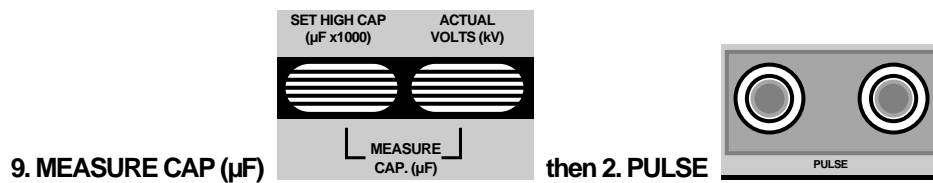

9. MEASURE CAP (µF)

then **2. PULSE**

Function	Result/Display
Two keypads and Pulse buttons work together to activate the Pulse Trac system to measure actual storage capacity of selected capacitor in µF.	<p>When the desired capacitor is selected (using the Capacitance switch or the Set High Cap. keypad), the two Measure Cap keypads are pressed (the two LEDs over the keypads are lit). The Pulse Trac system is activated by pressing both Pulse buttons. Hold both Pulse buttons until tone sounds. Release Pulse buttons. Display first shows CHg, then tst, then capacitor test value.</p> <p>Both Measure Cap. keypads, then both Pulse buttons, must be pressed simultaneously for this function to operate.</p> <p>Display is retained until power switched off or another Measure Cap. test is completed. Display value for capacitors larger than 975 µF is truncated (<i>i.e.</i> 1,000 µF=1.00).</p> <p>No energy is delivered to sample cuvette. (You can verify this, as the time constant for the Pulse Trac mode is 0.00).</p> <p>High voltage capacitor tolerance is ±10%. Low voltage capacitor tolerance is ±20%. (Other electroporation devices have variation standards that approach ±40% that can greatly</p>



10. SAMPLE RESISTANCE

Function	Result/Display
Activates the Pulse Trac system to monitor sample resistance (includes resistance in Pulse Controller II or PLUS module, if connected).	<p>Pressing these two keypads allows the unique Pulse Trac system to accurately monitor resistance of its internal arc protection circuitry, depending on the sample conductivity. Value displayed is derived from low current sine-waves into the sample (voltage well below 1 V).</p> <p>The display range is 5–999 ohms when the High Voltage/Low Capacitor mode is used. Use this to verify Pulse Controller II or PLUS module resistor settings.</p> <p>The range is 5–800 ohms when the Low Voltage/High Capacitor mode is used. Use this to estimate changes in sample conductivity when using the Capacitance Extender II (or PLUS) module.</p> <p>When the maximum value for the given resistance range is displayed, the actual resistance may be greater than or equal to the displayed value.</p> <p>Raise and Lower keys cannot be used when these two keys are active.</p>

11. LED

Function	Result/Display
LED (Light Emitting Diode) display	Displays Pulse Trac values and function indicators (3 digit).

12. Shocking Chamber Output Jack

Function	Result/Display
Shocking chamber output jack	Used as receptacle for red/black leads of shocking chamber when the Capacitance Extender II or PLUS module is used for electroporation.

3.2 Pulse Controller II Front Panel

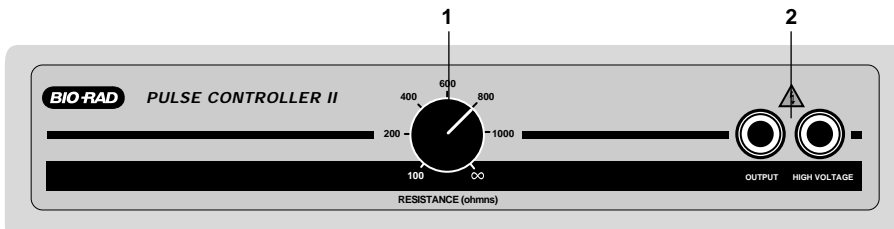

Fig. 3.2. The front control panel of the Pulse Controller II apparatus. Resistor selection switch (1) and shocking chamber output jack (2).



1. Resistance Selection Switch (ohms)

Function	Result/Display
Rotary switch selects one of six parallel resistors (100, 200, 400, 600, 800, 1,000 ohm) for Pulse Trac voltage delivery to sample cuvette.	Parallel resistors divert current (not voltage) from cuvette sample in Pulse Trac circuit. Used in high voltage electroporation to prevent high current from adversely affecting biological sample during electroporation.

Function	Result/Display
Selection of infinity (∞) position engages only 20 ohm protective series resistor and no parallel resistors in the Pulse Trac circuit.	Use the infinity (∞) position when you wish to use the Capacitance Extender II (or PLUS) module without disconnecting the Pulse Controller II (or PLUS) module. Display reads 999 for infinity (∞) position when the Low Caps. setting is used and 800 when the High Caps. setting is used.

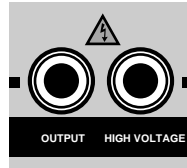

2. Shocking chamber output jack

Function	Result/Display
Connection point for leads from shocking chamber for high voltage (bacterial) electroporation.	Attaching the shocking chamber to Pulse Controller PLUS output jack gives increased circuitry protection to both the sample cuvette and the Gene Pulser II unit in case of an arc.

3.3 Pulse Controller PLUS Front Panel

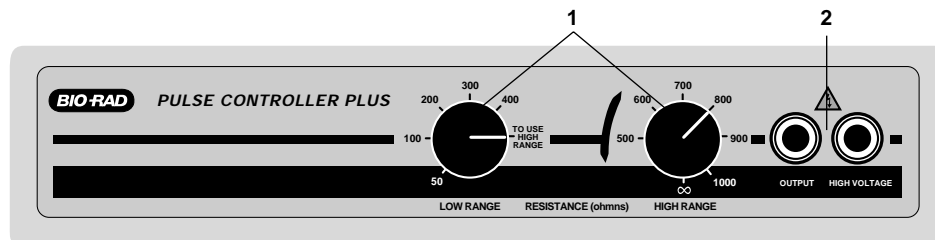
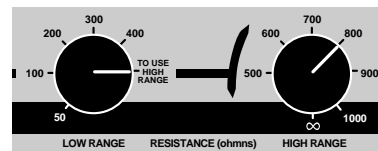

Fig. 3.3. The front control panel of the Pulse Controller PLUS apparatus. Resistor selection switches (1) and shocking chamber output jack (2).

1. Low Range and High Range Resistance Selection Switches (ohms)



Function	Result/Display
Two rotary switches work together to select one of eleven parallel resistors (50, 100, 200, 300, 400, 500, 600, 700, 800, 900, 1,000 ohms) for pulse delivery to sample cuvette.	Parallel resistors divert current (not voltage) from cuvette sample in Pulse Trac circuit. Used in high voltage electroporation to prevent high current from adversely affecting biological sample during electroporation.

Function	Result/Display
<p>(a) Left-most Low Range resistance switch dominates and selects one of five Low Range resistors (50, 100, 200, 300, 400 ohms) or activates the High Range resistance switch settings.</p> <p>To use High Range resistors, set Low Range switch at To Use High Range position, then using right rotary switch, select one of six parallel resistors (500, 600, 700, 800, 900, 1,000 ohms) for engaging parallel resistor in Pulse Trac waveform delivery to sample cuvette.</p> <p>Selection of infinity (∞) position engages no parallel resistors in the Pulse Trac circuit. Only the 20 ohm protective series resistor is engaged.</p>	<p>Use the infinity (∞) position when you wish to use the Capacitance Extender II (or PLUS) module without disconnecting the Pulse Controller II (or PLUS) module. Make certain that both switches are properly positioned.</p> <p>Display reads 999 for infinity (∞) position when Low Caps. setting is used and 800 when High Caps. setting is used.</p>

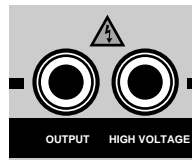

2. Shocking chamber output jack

Function	Result/Display
<p>Connection point for leads from shocking chamber for high voltage (bacterial) electroporation.</p>	<p>Attaching the shocking chamber to Pulse Controller PLUS output jack gives increased circuitry protection to both the sample cuvette and the Gene Pulser II unit in case of an arc.</p>

3.4 Capacitance Extender II Front Panel

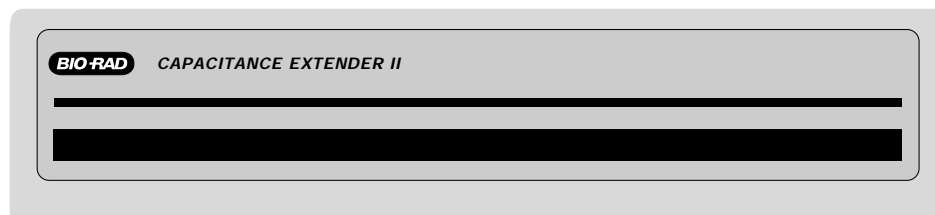

Fig. 3.4. Front panel of Capacitance Extender II. Note all capacitors are selected from Gene Pulser II unit front panel controls.

3.5 Capacitance Extender PLUS Front Panel

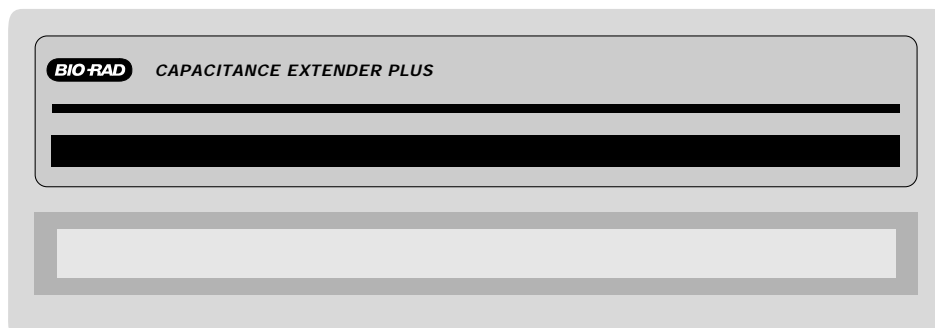

Fig. 3.5. Front panel of Capacitance Extender PLUS. Note all capacitors are selected from Gene Pulser II unit front panel controls.

Section 4 Operation

4.1 Instructions for Using the Gene Pulser II unit and the Pulse Controller II (or PLUS) Accessory

Typical *E. coli* High Voltage Electroporation Protocol

1. Set up the Gene Pulser and Pulse Controller II (or PLUS) units as described above. Make certain that the shocking chamber is connected to the output jack on the front of the Pulse Controller II (or PLUS) unit.
2. Turn on the Gene Pulser II apparatus using the power switch on the lower front panel. The LED above the oval Set Volts keypad will be illuminated. The display will read 0.00 if any one of the (high voltage) Low Cap. capacitors is selected. The display units are in kV.
3. Select the desired low capacitor (1.0, 3.0, 10, 25, or 50 μF) using the rotary Capacitance switch on the front of the Gene Pulser II unit. [Hint: The capacitor selected can be verified by activating Measure Cap. keypads, followed by pushing both pulse buttons until the tone sounds.]
4. With the Set Volts key active (the light above the key is lit), use the Raise and Lower keypads to adjust the voltage to the desired value. Recommended voltage is 1.8 kV for electroporation of a typical strain of *E. coli* using 25–40 μl of sample (cells/DNA/protein) in the 0.1 cm cuvette, or use 2.5 kV in 0.2 cm cuvettes. [Hint: Press the Raise and Lower keys simultaneously once, twice, or three times to obtain preset voltage values of 1.8 kV, 2.5 kV, or return to 0.00 kV, respectively.]
5. Select the desired parallel resistor using the rotary Resistance (ohms) switch(es) on the front of the Pulse Controller II (or PLUS) module. The Pulse Controller II module has one switch with seven different settings. The Pulse Controller PLUS module has two rotary switches that work together to provide 12 different settings, with the left switch dominating the selection process. [Hint: resistor selected can be verified by activating the Sample Resistance keypads.]

6. Place the cell/DNA/protein suspension at the bottom of the chilled electroporation cuvette between the aluminum plates. Use up to 0.4 ml (400 μ l) of solution in a 0.2 cm cuvette and up to 0.08 ml (80 μ l) in a 0.1 cm cuvette.
7. Insert the cuvette into the cuvette slide. Push the slide into the shocking chamber until the cuvette makes firm contact with the shocking chamber electrodes.
8. Press both Pulse buttons simultaneously and hold until tone sounds (**CHg** will flash and **PLS** will be displayed during this process). Release both Pulse buttons once tone sounds. The time constant is automatically displayed after every pulse.
9. Remove the cuvette from the chamber, immediately add the appropriate outgrowth medium to the cuvette, and quickly, but gently, resuspend the cells with a transfer pipette.
10. Transfer the cell suspension to a sterile culture tube and incubate under the appropriate outgrowth conditions.
11. Check and record the pulse parameters. Time constant is automatically displayed after every pulse. Check actual volts delivered.

4.2 Instructions for Using the Gene Pulser II unit with the Capacitance Extender II (or PLUS) Accessory Module

Typical Low Voltage Electroporation (Mammalian Cells) Protocol

1. Set up the Gene Pulser and Capacitance Extender II (or PLUS) units as described above. Make certain that the shocking chamber is connected to the output jack on the front of the Gene Pulser II unit. [Hint: You can keep the Pulse Controller II (or PLUS) connected to the Gene Pulser II unit when using the Capacitance Extender II (or PLUS) module. Simply set the Pulse Controller II (or PLUS) module to the infinity (∞) position. For the Pulse Controller PLUS module, make certain that both switches are properly positioned].
2. Turn on the Gene Pulser II apparatus using the power switch on the lower front panel. The LED above the oval Set Volts keypad will be illuminated. The display will read .000 if the (low voltage) High Cap. position is selected on the Capacitance switch (on the front panel of the Gene Pulser II unit). The display units are in kV.
3. Verify that the rotary Capacitance switch on the front of the Gene Pulser II unit is set to the High Cap. position (fully clockwise). Select the desired capacitor by pressing the Set High Cap (μ F x 1,000) keypad and then adjust capacitor value by using the Raise and Lower keypads.
4. With the Set Volts key active (the light above the key is lit), use the Raise and Lower keypads to adjust the voltage to the desired value. Suggested voltage of 0.2 to 0.4 kV, using 400–800 μ l (cells/DNA/protein) is recommended for electroporation of most mammalian cells in the 0.4 cm cuvette. [Hint: press the Raise and Lower keys simultaneously once, twice, or three times to obtain preset voltage values of 0.360 kV, 0.500 kV, or return to 0.00 kV, respectively. Capacitor selected can be verified by activating Measure Cap. keypads, followed by pushing both pulse buttons.]
5. Place the cell/DNA/protein suspension at the bottom of the electroporation cuvette between the aluminum plates (typically at room temperature). Use up to 0.8 ml (800 μ l) of solution in the 0.4 cm cuvette.
6. Insert the cuvette into the cuvette slide. Push the slide into the shocking chamber until the cuvette makes firm contact with the chamber electrodes.

7. Press both Pulse buttons simultaneously and hold until tone sounds (**CHg** will flash and **PLS** will be displayed during this process). Release both Pulse buttons when the tone sounds. The time constant is automatically displayed after every pulse. [Hint: large capacitors may require several seconds to safely charge. Do not release PULSE buttons until tone sounds.]
8. Remove the cuvette from the chamber and immediately add the appropriate outgrowth medium to the cuvette and quickly but gently resuspend the cells with a transfer pipette.
9. Transfer the cell suspension to a sterile container and incubate under the appropriate outgrowth conditions.
10. Check and record the pulse parameters. Time constant is automatically displayed after every pulse. Check actual volts delivered, and sample resistance.

Section 5

The Pulse Trac System

5.1 Pulse Trac System Description

The Pulse Trac system monitors and adjusts for the total resistance and capacitance of the complete circuit, including the sample in the cuvette. Sample resistance depends on both its conductivity and its cross-sectional area in the cuvette. The unique Pulse Trac circuitry monitors the resistance of the sample and delivers the desired voltage regardless of sample volume or conductivity. An advantage of the Pulse Trac system is that the measured τ for every pulse is based on the actual voltage delivered to the cuvette sample, including the entire electrical circuit and sample resistance; not on some theoretical calculation based on the settings you have chosen on the instrument or the overall pulse decay time. When you are optimizing electroporation with the Pulse Trac system, the electrical variables are controlled with exacting precision so that your results reflect only the biological variables in your experimental design.

Minimize any variation in the electrical circuitry between experiments with the Pulse Trac diagnostic algorithm (see Section 5.2 for operation instructions). This test algorithm examines the complete electrical circuit and electronically selects the right combination of capacitors to deliver the most accurate and reproducible pulse for optimal and consistent electroporation over the lifetime of the unit.

5.2 Pulse Trac Diagnostic Algorithm

This test algorithm tests and selects the optimal capacitor circuit of the Gene Pulser II unit and the Capacitance Extender II or PLUS module in the range of 100–1,075 μF . This is the key bank of electronically selected capacitors used in low voltage /high capacitance precision pulse delivery. When completed, this test algorithm is active as long as the power to the unit is on. The test algorithm tightens the already rigorous capacitor tolerance from $\pm 20\%$ to $\pm 10\%$ (other unit designs can have a capacitor variance as high as $\pm 40\%$).

Note: the high voltage capacitors in the Gene Pulser II unit are not part of this system, as they are pre-selected to the same 10% tolerance that this test algorithm provides.

To activate the Pulse Trac test algorithm, use Measure Cap and Pulse as follows (test requires ~30 seconds to complete).

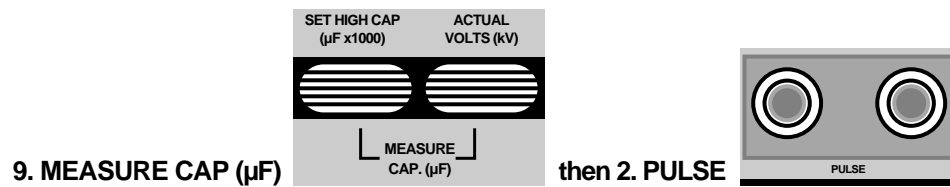

9. MEASURE CAP (µF)

then 2. PULSE

Function	Result/Display
Two Measure Cap. keypads and Pulse buttons work together to activate the Pulse Trac test algorithm to recalibrate the low voltage capacitors between 100–1,075 µF.	The two Measure Cap keypads are pressed (the two LEDs over the keypads are lit) and held continuously for 4 seconds until ALg is displayed. Release Measure Cap. keypads.
Test algorithm can be used when the Capacitance Extender II or PLUS module is properly connected to the Gene Pulser II unit and the capacitor selection switch is set in the High Cap. position.	The PULSE TRAC algorithm is activated by pressing both Pulse buttons. Hold both Pulse buttons continuously (about 25 seconds) until a long tone sounds and dnE is displayed. Display characters will vary as test progresses through the circuit. Release Pulse buttons.
	After tone sounds and Pulse buttons are released, dnE (done) will flash and the display will appear 00.0. The Measure Cap. keypads are still active (lights above keypads are lit).
	When the test has been completed, select any of the low voltage/ High (value) capacitors using the Set High Cap. keypad and the Raise /Lower keypads as described in Section 3.1. Any capacitor now selected (100–1,075 µF range) will be verified as a precision capacitor with the flashed Prc CAP display.
	Low voltage capacitor tolerance is now ±10%. High voltage capacitor tolerance is already ±10%. (Other electroporation devices have variation standards that approach ±40% that can greatly hinder consistent electroporation results.)
	The test algorithm is locked on until the power to the unit is turned off. To discontinue this test after the ALg has been selected, turn the unit power off.
	No energy is delivered to sample cuvette during this test. You can verify this, as the time constant for this Pulse Trac mode is 000 and the Actual Volts (kV) delivered value is .000.

Section 6 Instrument Diagnostics and Troubleshooting

Problem	Likely Cause
1. Display does not light when unit is turned on.	Power is not supplied to electronics. Check power cord and wall outlet power source. Check that power switch is on. Check/replace fuse.
2. Apparatus displays NO when pulse button are pressed.	Voltage set at zero. Press Set Volts keypad. Adjust voltage with Raise and Lower keypads to desired voltage. Capacitance (μF) select switch set on High Cap., but Capacitance Extender II or PLUS module is not properly connected to Gene Pulser II unit. Check leads as connected to rear of Gene Pulser II unit and RS232 cable connection.
3. When the pulse buttons are pressed, the display continues to flash CHg , but the tone does not sound.	No pulse delivery. Pulse buttons not depressed long enough. Large capacitors or conditions that generate long time constants require a longer charging time (several seconds) to maintain safe pulse delivery. The pulse buttons should not be released until the tone sounds. Only one pulse button depressed. Both of the red pulse buttons must be pressed continuously until the tone sounds for pulse delivery. Sample resistance too high. Lower sample resistance (<i>e.g.</i> , increase ionic strength of the media). Use the Gene Pulser II unit with the Pulse Controller II or PLUS module for pulse delivery into high resistance samples.
4. Arcing in the cuvette	Arcing in the cuvette is usually caused by a sample medium that is too conductive. The limit of conductivity depends on the voltage, electrode gap, and sample volume. When using the Pulse Controller II or PLUS module, arcs occasionally occur in high voltage delivery (typical <i>E. coli</i> protocol) if the sample is 10 meq or higher. Causes of excessive conductivity include: <ol style="list-style-type: none"> 1. Washing and resuspending cells in a buffer that is too high in ionic strength. 2. Insufficient washing of cells; salts of growth medium are not removed. 3. Lysed cells in the preparation.; cell contents contribute to conductivity. 4. DNA solution too high in salt content. Ligation mixture, or CsCl carry-over during DNA purification. Dilute DNA 1/100 with ultra-pure water or use Prep-A-Gene[®] purification matrix. 5. Electroporation of cells above 0 °C (cell lysis).

Section 7 Specifications and Product Information

7.1 System Specifications

Gene Pulser II System

Input voltage	100/120 V RMS, 50/60 Hz 220/240 V RMS, 50/60 Hz
Input current	15 amp RMS
Maximum output voltage and current	2,500 V at 125 amp peak (normal load); limited to 1,500 A during arc.
Output waveform	Pulse Trac exponential decay with RC time constant dependent on sample and capacitor selected
Output voltage adjustment	50–2,500 V range (depending on the capacitor) with 10 V adjustment precision for the high voltage range and 2 V for the low-voltage range (50–500 V).
Ambient operating environment	Temperature 0–35 °C Humidity 0–95% without condensation
Regulatory	Passes requirements of IEC 1010. In addition, the system passes requirements for FCC, Class A.
Dimensions	34 x 31 x 19 cm
Weight	10.41 kg

Pulse Controller II System

Selectable resistance, ohms, (parallel)	100, 200, 400, 600, 800, 1,000, infinity ohms; measured with Gene Pulser II apparatus
Dimensions	23 x 31 x 7.7 cm
Weight	1.7 kg

Pulse Controller PLUS System

Selectable resistance, ohms, (parallel)	50, 100, 200, 300, 400, 500, 600, 700, 800, 900, 1,000, infinity ohms; measured with Gene Pulser II apparatus
Dimensions	23 x 31 x 7.7 cm
Weight	1.87 kg

Capacitance Extender II System

Selectable capacitors, μF	25 to 1,075 μF , in 25 μF increments; measured with Gene Pulser II apparatus
Dimensions	23 x 31 x 9.7 cm
Weight	2.57 kg

Capacitance Extender PLUS System

Selectable capacitors, μF	25 to 3,275 μF , in 25 μF increments; measured with Gene Pulser II apparatus
Dimensions	23 x 31 x 13.7 cm
Weight	3.64 kg

7.2 Product Information

Catalog Number	Product Description
165-2105	Gene Pulser II Apparatus, 100/120 V, 50/60 Hz; includes 1 shocking chamber, 15 sterile sample cuvettes (five 0.1 cm gap, five 0.2 cm gap and five 0.4 cm gap), 1 cuvette rack
165-2106	Gene Pulser II Apparatus, 220/240 V, 50/60Hz; includes 1 shocking chamber, 15 sterile sample cuvettes (five 0.1 cm gap, five 0.2 cm gap and five 0.4 cm gap), 1 cuvette rack
165-2107	Capacitance Extender II, 25–1075 μ F range measured by Gene Pulser II apparatus; includes integrated leads
165-2108	Capacitance Extender PLUS, 25–3,275 μ F range measured by Gene Pulser II apparatus; includes integrated leads
165-2109	Pulse Controller II, 100-1,000 ohm range, seven settings (100, 200, 400, 600, 800, 1,000, infinity ohms); includes integrated leads
165-2110	Pulse Controller PLUS, 50–1,000 ohm range, twelve settings (50, 100, 200, 300, 400, 500, 600, 700, 800, 900, 1,000, infinity ohms); includes integrated leads
165-2111	Gene Pulser II /E.coli Pulser™ shocking chamber
165-2095	Gene Pulser Cuvette Rack
165-2094	Gene Pulser Electroprotocols
165-2088	Gene Pulser Cuvettes, 0.4 cm electrode gap, package of 50, sterile
165-2086	Gene Pulser/E. coli Pulser Cuvettes, 0.2 cm electrode gap, package of 50, sterile
165-2089	Gene Pulser /E. coli Pulser Cuvettes, 0.1 cm electrode gap, package of 50, sterile

Appendix A Review of Electroporation Fundamentals

Electroporation is a physical process that transiently permeabilizes prokaryotic and eukaryotic cell membranes with an electrical pulse, thus permitting cell uptake of a wide variety of biological molecules. Electro-transformation provides the researcher with a valuable alternative to chemical and other physical methods that may be ineffective or toxic when transforming certain cell types.

How Electroporation Works

The delivered pulse decays exponentially through time, and is defined by two pulse parameters, the initial field strength (kV/cm) and the time constant (τ). Both the field strength and the time constant must be characterized for each cell type. You determine the field strength by selecting the voltage (kV) that is delivered across the cuvette electrode gap (cm). Generally, the larger the cell, the lower the field strength required for efficient electroporation. The time constant, τ (msec) = resistance, R (ohms) x capacitance, C (microfarads), in the complete pulse circuit is equivalent to the amount of time it takes for the initial peak voltage (V_0) to drop to the value of V_0/e ; this is a decay time for the pulse to decrease to a value of about 37% of V_0 (Fig. A.1).

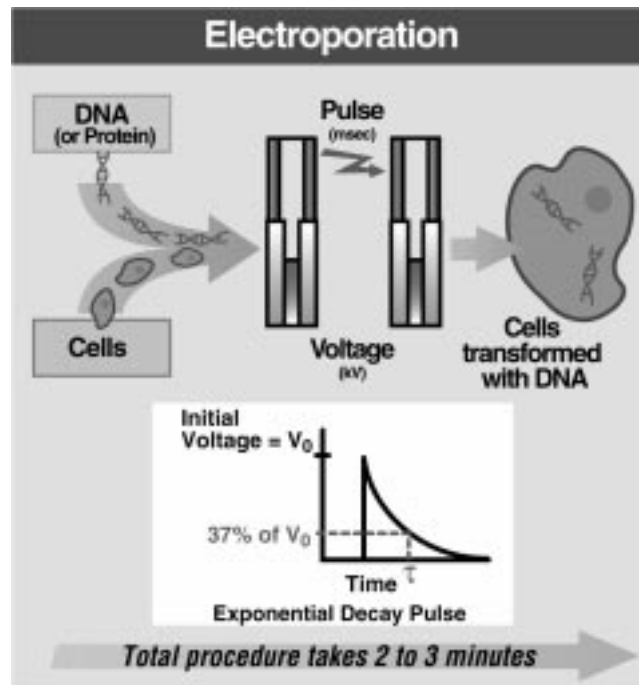

Fig. A.1. Electroporation delivers an electrical pulse to permeabilize cell membranes for the uptake of biological molecules. The pulse decays exponentially over a short time (msec). The time constant, τ (msec) is the time required for the initial voltage (V_0) to decay to 37% of V_0 . Also, the time constant, (τ , msec) = resistance, R (ohms) x capacitance, C (microfarads) in the complete pulse circuit, ($\tau = R \times C$).

Key Optimization Concepts

Electroporation must be optimized for each cell type, since the pulse must penetrate cells that differ in diameter, membrane/cell wall composition, and in the medium needed to support membrane/cell wall integrity during electroporation. Key parameters for optimal electroporation are:

The time constant (τ)

This is an essential parameter because it precisely describes each pulse delivered to your sample. τ is equivalent to the amount of time it takes for the initial peak voltage (V_0) to drop to the value of V_0/e ; this is a decay time for the pulse to decrease to a value of about 37% of V_0 , (Figure A.1). The time constant for each pulse is also the product of the total resistance and capacitance of the pulse circuit [$\tau = R \times C$].

The resistance and capacitance of the pulse circuit will directly influence the rate of decay [τ , (msec)] of the exponential pulse waveform that is delivered to the sample.

The resistance (R) of the sample depends on both its conductivity and its cross-sectional area (see below). Various cuvette gap sizes are available that can hold different sample volumes.

Effect of Sample Volume on Time Constant*

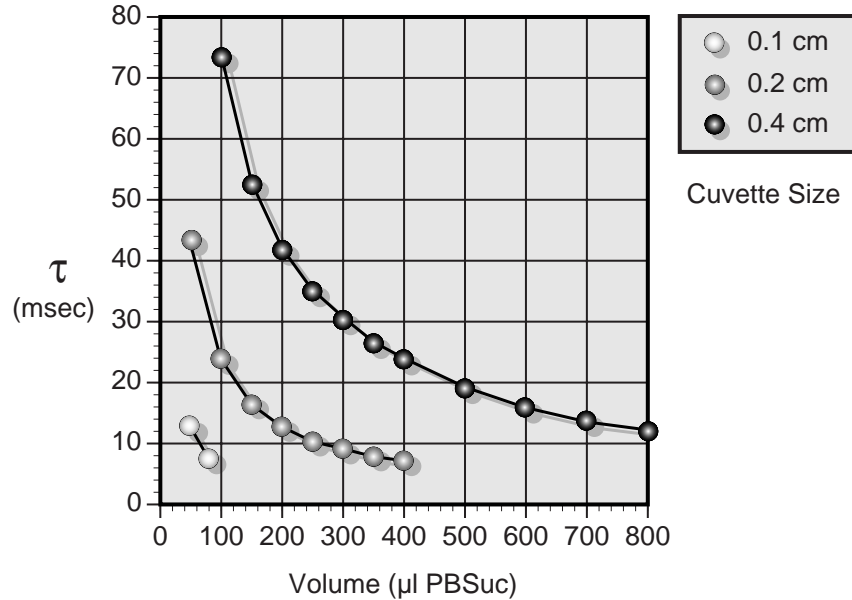

*Various volumes of cold phosphate buffered sucrose (272 mM sucrose, 7 mM potassium phosphate, pH 7.4, 1 mM MgCl₂) pulsed using 200 V and 50 μF in 0.1 cm, 0.2 cm and 0.4 cm cuvettes. The resulting time constants are reported.

The capacitance (C) is determined by the selected capacitor of the pulse circuit within the electroporation device. Optimal time constants (τ) for most prokaryotic cells range from 5 to 10 msec. Most mammalian cells require a time constant (τ) of 15 to 40 msec.

The field strength (E) applied to the sample

Field strength (E) is the initial voltage (V₀) set by the user and delivered by the Gene Pulser II apparatus across the distance (cm) between the electrodes in the cuvette (E= kV/cm). The Pulse Trac system automatically measures τ and the actual peak voltage delivered to the cell sample for each pulse and displays them as easy-to-read LED values. This allows the user to monitor and reproduce the time constants and the field strengths reported by other laboratories for optimal electro-transformation. Optimal field strength for bacteria is typically 16 to 19 kV/cm and 0.5 to 1.0 kV/cm for most mammalian cells.



Artisan Technology Group is your source for quality new and certified-used/pre-owned equipment

- FAST SHIPPING AND DELIVERY
- TENS OF THOUSANDS OF IN-STOCK ITEMS
- EQUIPMENT DEMOS
- HUNDREDS OF MANUFACTURERS SUPPORTED
- LEASING/MONTHLY RENTALS
- ITAR CERTIFIED SECURE ASSET SOLUTIONS

SERVICE CENTER REPAIRS

Experienced engineers and technicians on staff at our full-service, in-house repair center

*InstraView*SM REMOTE INSPECTION

Remotely inspect equipment before purchasing with our interactive website at www.instraview.com ↗

WE BUY USED EQUIPMENT

Sell your excess, underutilized, and idle used equipment. We also offer credit for buy-backs and trade-ins. www.artisanng.com/WeBuyEquipment ↗

LOOKING FOR MORE INFORMATION?

Visit us on the web at www.artisanng.com ↗ for more information on price quotations, drivers, technical specifications, manuals, and documentation

Contact us: (888) 88-SOURCE | sales@artisanng.com | www.artisanng.com