



## Artisan Technology Group is your source for quality new and certified-used/pre-owned equipment

- FAST SHIPPING AND DELIVERY
- TENS OF THOUSANDS OF IN-STOCK ITEMS
- EQUIPMENT DEMOS
- HUNDREDS OF MANUFACTURERS SUPPORTED
- LEASING/MONTHLY RENTALS
- ITAR CERTIFIED SECURE ASSET SOLUTIONS

### SERVICE CENTER REPAIRS

Experienced engineers and technicians on staff at our full-service, in-house repair center

### *InstraView*<sup>SM</sup> REMOTE INSPECTION

Remotely inspect equipment before purchasing with our interactive website at [www.instraview.com](http://www.instraview.com) ↗

### WE BUY USED EQUIPMENT

Sell your excess, underutilized, and idle used equipment. We also offer credit for buy-backs and trade-ins. [www.artisanng.com/WeBuyEquipment](http://www.artisanng.com/WeBuyEquipment) ↗

### LOOKING FOR MORE INFORMATION?

Visit us on the web at [www.artisanng.com](http://www.artisanng.com) ↗ for more information on price quotations, drivers, technical specifications, manuals, and documentation

**Contact us:** (888) 88-SOURCE | [sales@artisanng.com](mailto:sales@artisanng.com) | [www.artisanng.com](http://www.artisanng.com)



# Thermal Cycler

## Instruction Manual

### Catalog Numbers

**170-8720**

**170-8722**

**170-8724**

**170-8726**



## NOTICE TO PURCHASER

This base unit, Serial No. \_\_\_\_\_, in combination with its immediately attached Bio-Rad sample block module(s), constitutes a thermal cycler whose purchase conveys a limited non-transferable immunity from suit for the purchaser's own internal research and development and for use in applied fields other than Human In Vitro Diagnostics under one or more of U.S. Patents Nos. 5,656,493, 5,333,675, 5,475,610 (claims 1, 44, 158, 160-163 and 167 only), and 6,703,236 (claims 1-7 only), or corresponding claims in their non-U.S. counterparts, owned by Applera Corporation. No right is conveyed expressly, by implication or by estoppel under any other patent claim, such as claims to apparatus, reagents, kits, or methods such as 5' nuclease methods. Further information on purchasing licenses may be obtained by contacting the Director of Licensing, Applied Biosystems, 850 Lincoln Centre Drive, Foster City, California 94404, USA.

This iCycler thermal cycler, when combined with an IQ5 or MyIQ detection module bearing a valid label license under U.S. Patent No. 6,814,934, constitutes a real-time thermal cycler licensed under U.S. Patent No. 6,814,934 and corresponding claims in any Canadian counterpart patent thereof owned by Applera Corporation, for use solely in research and all applied fields except human and veterinary in vitro diagnostics, provided that the real-time thermal cycler royalty fee that is applicable to said thermal cycler has been paid. No rights are conveyed expressly, by implication or estoppel to any patents on real-time methods, including but not limited to 5' nuclease assays, or to any patent claiming a reagent or kit. For further information on purchasing license rights, contact the Director of Licensing at Applied Biosystems, 850 Lincoln Centre Drive, Foster City, California, 94404, USA.

## Safety Information



The sample block of the iCycler can reach temperatures of 100°C and the heated lid maintains a temperature of 105°C during operation of the instrument. The heated lid should remain closed at all times during operation to prevent accidental skin burns. Always allow the sample block to return to its idle temperature before opening the lid and removing samples.

There is an LED on top of the 96-well, 60-well, and 384-well reaction module that indicates the temperature of the reaction block. The LED is off when the sample block temperature is below 30°C. It flashes on and off when the block temperature is between 30 and 50°C, and it glows steadily when the temperature exceeds 50°C. The 2x48 well module does not contain the LED indicator. Therefore, caution should be used when the instrument is in service.

Always connect the power supply to a 3-prong, grounded AC outlet rated 10 A/100–120 V, or 5 A/220–240 V using the AC power cord provided with the iCycler. Do not use an adaptor to a two-terminal outlet.

Never remove the outer casing of the iCycler. There are no user-serviceable parts for this instrument. Call your local Bio-Rad office for instrument service.

To insure adequate cooling of the iCycler, be sure that there is at least 4 inches clearance around the sides of the thermal cycler. Do not block the fan vents on the sides of the unit.

Do not operate the iCycler in extreme humidity (>90%) or where condensation can short the internal electrical circuits of the thermal cycler.

Inspect the ribbon cable for nicks or other damage. If present, do not use the unit and call Technical Support.

Before inserting the reaction module, ensure no loose hardware components are present in the module or chassis.

Do not remove or attach a reaction module without first powering down the iCycler.

Ensure the unit power is in the off position if a metallic object falls into the chassis.

Periodically inspect your iCycler for obvious damage that might affect normal operation.

Care should be taken to ensure that flammable and conductive materials are not in close proximity of the iCycler. If a flammable material or conductive material is poured into the system, the power must be turned-off immediately.

**Notice**

This Bio-Rad instrument is designed and certified to meet EN-61010 safety standards. EN-61010 certified products are safe to use when operated in accordance with the instruction manual. This instrument should not be modified in any way. Alteration of this instrument will:

- Void the manufacturer's warranty.
- Void the EN-61010 safety certification.
- Create a potential safety hazard.

Bio-Rad is not responsible for any injury or damage caused by the use of this instrument for purposes other than those for which it is intended, or by modifications of the instrument not performed by Bio-Rad or an authorized agent.

This instrument is intended for laboratory use only.

This product conforms to the “Class A” standards for electromagnetic emissions intended for laboratory equipment applications. It is possible that emissions from this product may interfere with some sensitive appliances when placed nearby or in the same circuit as those appliances. The user should be aware of this potential and take appropriate measures to avoid interference.

# Table of Contents

	Page
<b>Section 1 Introduction .....</b>	<b>1</b>
1.1 Overview.....	1
1.2 Features.....	2
1.3 System Set Up.....	2
1.3.1 Unpacking.....	2
1.3.2 Voltage Conversion and Power Cable Connection.....	3
1.3.3 Cable Connections .....	4
1.3.4 Removing and Attaching a Reaction Module.....	4
1.3.5 Powering Up .....	5
1.4 Loading the Reaction Module .....	6
1.5 iCycler Keypad .....	8
1.6 System Accessories and Options .....	11
1.7 What's in This Manual.....	12
<b>Section 2 Logging On .....</b>	<b>12</b>
2.1 User Names and Information.....	13
2.1.1 Creating a New User .....	13
2.1.2 Logging in as a Registered User.....	14
2.1.3 Changing the Current User.....	14
2.1.4 Deleting a User .....	14
2.2 Home Screen.....	14
2.3 Quick Start Procedure .....	15
2.3.1 Editing a Protocol .....	16
2.3.2 Creating a Protocol.....	16
<b>Section 3 Thermal Cycling Protocols .....</b>	<b>17</b>
3.1 Overview.....	17
3.2 Protocol Display.....	17
3.2.1 Text Description .....	18
3.2.2 Graphical Representation .....	18
3.3 Protocol Parameters.....	19
3.3.1 Temperature and Dwell Time Ranges .....	19
3.3.2 Advanced Programming Options .....	19
3.4 Protocol Library Screen.....	20
3.4.1 User Names and the Bio-Rad Folder .....	21
3.4.2 Folder Protocol Name .....	21
3.4.3 Protocol Name .....	22
3.5 Creating and Editing Protocols .....	22
3.5.1 Specifying Time Values.....	23
3.5.2 Specifying Temperature Values .....	23
3.5.3 Specifying Cycle Repeats .....	23
3.6 Creating and Editing Protocols: Advanced Options.....	23
3.6.1 Temperature and Dwell Time Options (F3-Option) .....	23
3.6.2 Programming a Temperature Gradient (F3-Option) .....	25
3.6.3 Changing the Number of Cycles or Steps (F4-Add/Del).....	26
3.7 Completing Protocols.....	26

<b>Section 4</b>	<b>Running Protocols</b>	<b>27</b>
4.1	How To Run a Protocol	27
4.1.1	Run Setup Screen	27
4.1.2	Running a Protocol	28
4.1.3	Running Gradient Protocols	30
4.2	Options While a Protocol is Running	30
4.2.1	Displaying The Home Screen While a Protocol is Running	30
4.2.2	Switching Between Blocks (2 x 48) Well Reaction Modules	30
4.2.3	A Power Failure While a Protocol is Running	31
4.2.4	Pausing a Running Protocol	31
4.2.5	Terminating a Running Protocol	31
4.2.6	End of Run Screen	31
4.3	Viewing Reports	32
4.4	Uploading Reports to the Computer	33
<b>Section 5</b>	<b>Utilities</b>	<b>34</b>
5.1	View Reports	34
5.2	Setting the Date and Time	34
5.3	Setting the User Preferences	35
5.3.1	Setting Beeper Options	35
5.3.2	Changing PIN Options	36
5.3.3	Default Hot Start Selection	36
5.3.4	Hot Start Temperature	36
5.3.5	Temperature Measurement Mode	36
5.3.6	Default Sample Volume	37
5.4	Instrument Check	37
5.5	Device Configuration	37
5.6	Service Options	37
5.7	Getting Printer Status	38
5.8	Display Firmware Version	38
5.9	Uploading New Versions of Firmware	38
<b>Section 6</b>	<b>Care and Maintenance</b>	<b>39</b>
6.1	Cleaning the Unit	39
6.2	Replacing a Fuse or a Battery	39
6.3	Troubleshooting Procedure	40
6.4	Error Messages	41
<b>Appendix A</b>	<b>Specifications</b>	<b>43</b>
<b>Appendix B</b>	<b>Warranty</b>	<b>45</b>
<b>Appendix C</b>	<b>Product Information</b>	<b>46</b>

# Section 1 Introduction

## 1.1 Overview

The Polymerase Chain Reaction (PCR)\* has been one of the most important developments in Molecular Biology. PCR has greatly accelerated the rate of genetic discovery, making critical techniques relatively easy and reproducible.

The iCycler thermal cycling instrument provides the optimum performance for PCR and other thermal cycling techniques. The iCycler incorporates a peltier driven heating and cooling system for superb thermal performance characteristics. See the Specifications section at the end of this manual for detailed information regarding the rates of heating and cooling, accuracy and uniformity of the thermal sample reaction module. Rigorous testing of thermal block temperature accuracy, uniformity, consistency and heating/cooling rates was conducted to insure reliable and reproducible experimental results.

The iCycler is an oil-free thermal cycling system. No oil is required in the tubes or in the wells of the sample reaction module. The iCycler features a heated lid and an anti-condensation enclosure surrounding the sample area eliminating the need for any oil overlay in the sample tubes. The pressure of the iCycler heated lid is self adjusting, which allows it to accommodate tubes or plates of varying heights.

The iCycler offers three modes of temperature monitoring and control for the 96 x 0.2 ml system and 60 x 0.5 ml system:

- via an in-sample temperature probe
- via the calculated sample temperature given a specific sample volume
- via the actual sample block temperature

The 2 x 48 x 0.2 ml system is monitored and controlled via the sample block temperature or the calculated sample temperature, given a specific volume.

The iCycler 384 well system is monitored and controlled via the calculated sample temperature given a specific sample volume.

All modes of temperature control yield excellent results in our test protocols.

The iCycler comes with exceptionally intuitive programming software, offering a graphical view of the programmed protocols as well as a complete description of the programmed protocol. Each protocol may include as many as 9 cycles with 9 steps each and up to 600 repeats of each cycle. Protocols may be linked for even further flexibility. All protocols may be named alphanumerically using the dual-function keypad. Protocols may be organized into protocol folders to enhance protocol organization. Additionally, features such as time and temperature increments and decrements are built into the iCycler protocol editing screens.

The iCycler uniquely provides a modular approach to expanding the features of the instrument including a variety of sample block formats, an upgrade path for the programming, and the modular iCycler iQ™ Real Time PCR Detection System.

\* Practice of the patented polymerase chain reaction (PCR) process requires a license. The iCycler thermal cycler is an authorized thermal cycler and may be used with PCR licenses available from Applied Biosystems. Its use with authorized reagents also provides a limited license in accordance with the label rights accompanying such reagents.

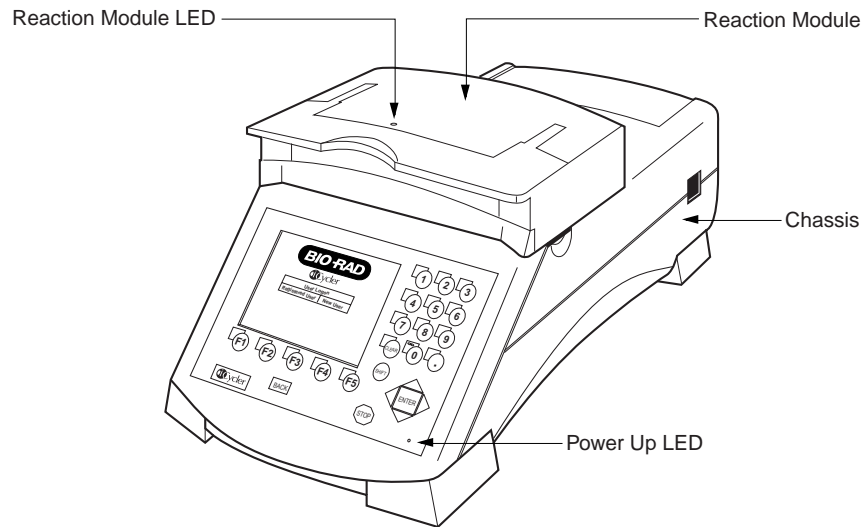

Fig. 1.1. iCycler.

## 1.2 Features

- Graphical representation of protocols combined with standard language templates.
- User-friendly software, including menu driven software, ready-made protocol templates and user-defined preference file.
- Direct modular upgrade to Real-Time PCR monitoring.
- Interchangeable reaction modules.
- Maximum sample flexibility; reaction modules accommodate 0.2-ml tubes, strips and 96-well plates, 0.5-ml tubes, and 384-well plates.
- Temperature monitoring and control can be specified by instrument algorithm, in-sample probe, or reaction module block mode.
- Optional security feature for protocols and folders.
- Run results report and validation report.
- NIST-traceable temperature performance.

## 1.3 System Set Up

### 1.3.1 Unpacking

The iCycler is shipped in two boxes:

- Box with the chassis, power cord, instruction manual, and fuses.
- Box with the reaction module, regulatory documentation, the in-sample temperature probe (for the 96 x 0.2 ml block or the 60 x 0.5 ml block). This box may also include a firmware upgrade disk and cable to ensure that the most current version of firmware is available for the block system shipped.



Carefully remove the contents of each shipping box. To remove the chassis, lift it out by grasping the underside of the unit. Remove the plastic bag and inspect the instrument for any external damage. Check off all parts against the supplied packing list.

Your iCycler was carefully tested at the factory and was shipped in good working order. If any part is missing or damaged, contact Bio-Rad Laboratories immediately.

### 1.3.2 Voltage Conversion and Power Cable Connection

The iCycler is equipped to operate at 100–120 V or 220–240 V. Prior to connecting the power cord to the instrument's power entry module and the wall outlet, verify that the voltage indicated on the iCycler power selector switch matches your line voltage. If it does not, use the following procedure to make the conversion. Refer to Figures 1.2 and 1.3.

**Warning: Failure to follow this procedure may result in damage to the unit and invalidation of the warranty.**

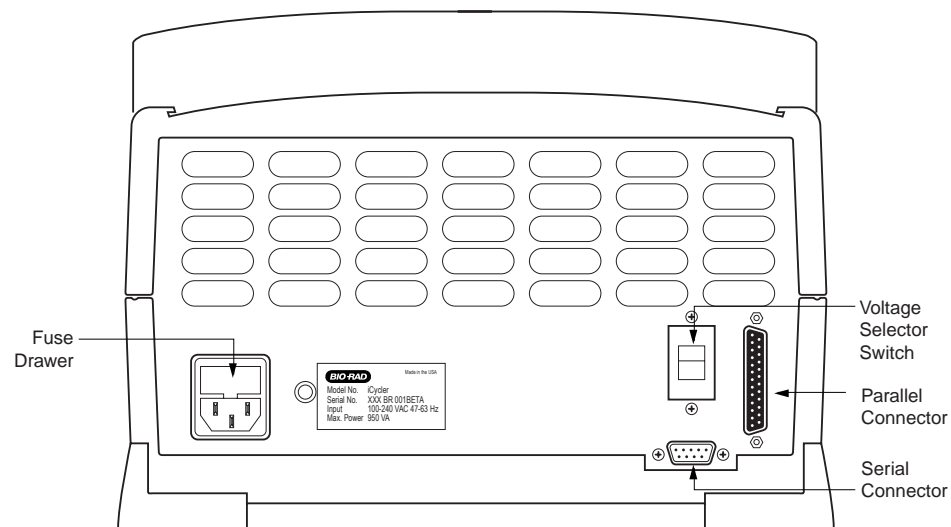

**Fig. 1.2. iCycler rear view.**

1. Disconnect the power cord from the unit.
2. Set the voltage select switch to 115 for 100–120 V operation or 230 for 220–240 V operation using a flat-blade screwdriver
3. Remove the fuse drawer with a small-blade screwdriver or similar tool.
4. Pull the fuse holder out of the fuse drawer and, if necessary, replace the fuses with ones having the correct current rating.
  - a. For 100–120 V operation: Use 8.0 A, 5 x 20 mm, Type T fuses.
  - b. For 220–240 V operation: Use 4.0 A, 5 x 20 mm, Type T fuses.
5. Reinsert the fuse drawer into the power entry module. Press gently until it snaps into place.
6. Insert the power cord plug into the power entry module. Plug the power cord into a properly grounded outlet.

**Note:** The iCycler should be placed in a location that will allow free access to the main power switch.

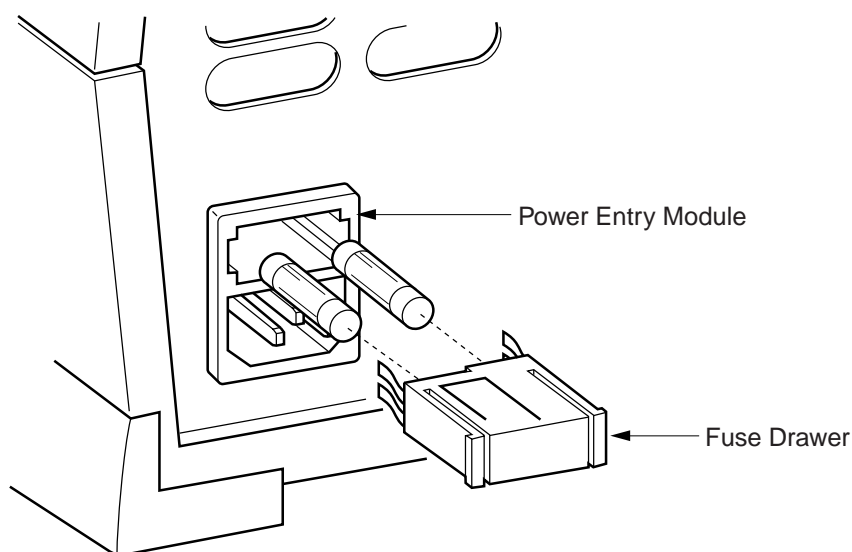

**Fig. 1.3. Changing fuses.**

### 1.3.3 Cable Connections

In addition to the power cable connector, the rear panel of the iCycler contains connectors for the following devices:

- Serial port connector: Use this to connect a PC computer to the iCycler. This will allow you to download reports to the computer. The serial cable must be shielded, with 9-pin male/female D-connectors, and it must support transmit, receive, and ground. It should be connected to PC COM 1 or COM 2. The cable should be wired for straight-through connection (pin 1 to pin 1, etc.)
- Parallel port connector: Use this to connect a PC-compatible printer to the iCycler. This will allow you to print results and validation reports. The cable should be IEEE 1284/Centronics-compatible and shielded, and it should have a male 25-pin D-connector at the iCycler end. The connector at the other end should meet the requirements of your printer.

**Note:** When using a printer, it is recommended that the printer be turned off before the iCycler.

### 1.3.4 Removing and Attaching a Reaction Module

**The iCycler must be powered down when removing or attaching reaction modules. Removing or attaching a reaction module while the iCycler is powered up may damage the instrument.**

When removing or attaching a reaction module, allow approximately 16" clearance from the bench surface. The reaction modules are fastened by latches on each side.

To remove a reaction module,

1. Lift the reaction module lid handle.
2. Slide the lid as far back as it will go.

3. Lift the green latches on either side of the reaction module and rotate until they contact the lid as shown in Figure 1.4.
4. Lift out the reaction module using the handle.

To attach a reaction module,

1. Slide the lid of the reaction module as far back as possible.
2. Rotate the green latches until they contact the lid as shown in Figure 1.4.
3. Lift the reaction module by the handle.
4. Insert reaction module. Note that the front portion will engage before the rear.
5. Rotate the green latches down into their home position to clamp the reaction module in place.
6. Slide lid forward to close.

**Note:** The rear sliding cover should move forward with the lid. If the rear sliding cover does not move forward, remove and reinsert the reaction module.

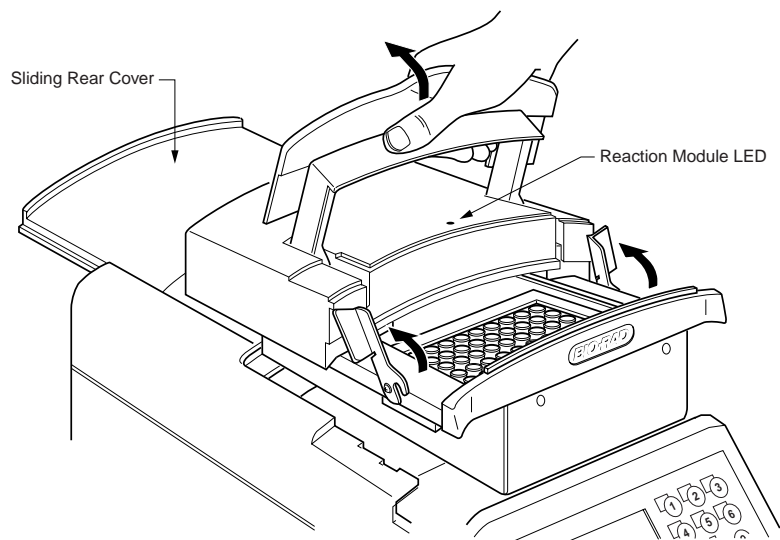

**Fig. 1.4. Replacing a reaction module.**

### 1.3.5 Powering Up

Before powering up the iCycler, place it where there is sufficient ventilation and access to the reaction module and the mains switch. We recommend at least 4" clearance to left and right and 4" to rear. For convenience in handling the reaction module, 16" clearance from bench surface is needed to remove the reaction module and about 12–13" to open the lid.

Upon powering up, a **Self Test** screen is displayed, indicating that the machine is checking the status of its systems including the RAM and ROM, thermistors, lid heater power, lid heater heating, control of peltier elements, the joule heaters, display, and keyboard. If any system fails, an appropriate message and instructions will be provided on the screen. If all systems pass, the **Logon** screen is displayed (see Figure 2.1.)

There is one amber LED on the bottom right of the front panel of the iCycler that glows when the instrument is powered up (see Figure 1.1). If the LED does not glow, then the unit is not receiving power. Refer to Section 6, Care and Maintenance.

An amber LED that is off at block temperatures below 30 °C; flashes at temperatures between 30 °C and 50 °C, and glows steady when the temperature exceeds 50 °C for all reaction modules except the 2x48 well module.

When powering up an iCycler with a 2 x 48 x 0.2 ml reaction module, allow 10 minutes before initiating a protocol.

## 1.4 Loading the Reaction Module

For optimal performance of the iCycler, we recommend Bio-Rad tubes, plates, and accessories as follows:

Catalog Number	Product Description	Reaction Module
TWI-0201	<b>0.2 ml Tubes With Domes Caps</b> , natural, 1,000 (2 bags of 500)	96 x 0.2 ml 2 x 48 x 0.2 ml
TFI-0201	<b>0.2 ml Tubes With Flat Caps</b> , natural, 1,000	96 x 0.2 ml 2 x 48 x 0.2 ml
TBS-0201	<b>0.2 ml 8-Tube Strips Without Caps</b> , natural, 125	96 x 0.2 ml 2 x 48 x 0.2 ml
TCS-0801	<b>Domed 8-Cap Strips</b> , for 0.2 ml tubes and plates, natural, 120	96 x 0.2 ml 2 x 48 x 0.2 ml
TCS-0803	<b>Optical Flat 8-Cap Strips</b> , for 0.2 ml tubes and plates, ultraclear, 120	96 x 0.2 ml 2 x 48 x 0.2 ml
TBS-1201	<b>0.2 ml 12-Tube Strips Without Caps</b> , natural, 100	96 x 0.2 ml 2 x 48 x 0.2 ml
TCS-1201	<b>Domed 12-Cap Strips</b> , for 0.2 ml tubes and plates, natural, 200	96 x 0.2 ml 2 x 48 x 0.2 ml
TBI-0502	<b>0.5 ml Tubes With Flat Caps</b> , natural, 800 (8 bags of 100)	96 x 0.2 ml
MLP-9601	<b>Multiplate 96-Well 0.2 ml Unskirted PCR Plates</b> , natural, 2	96 x 0.2 ml
MSP-3842	<b>Microseal 384-Well PCR Plates</b> , version 2.0, natural, 50	384 well
MSB-1001	<b>Microseal 'B' Adhesive Seals</b> , 100	96 x 0.2 ml
223-9442	<b>96-Well PCR Plate Sealing Mats</b> , 5	96 x 0.2 ml

The recommended sample volume for 0.2 ml tubes or 96 well plates is 15–100 µl; for the 0.5 ml tubes is 50–200 µl; and for the 384 well plates is 5–20 µl.

### Use of Thermal Isolation Rings

The iCycler Sealing Ring optimizes temperature isolation of the sample reaction block area. These sealing rings are intended for use with the iCycler 96 x 0.2 ml reaction module, and the 60 x 0.5 ml reaction module (Figure 1.5). The sealing ring for the 96-well system is green, and the one for the 60 well system is blue.

These Thermal Sealing Rings offer structural support, minimizing the number of tubes required in any experiment. Note that the thermal isolation ring has a slot for use with the sample probe. When using the sample probe for temperature control, position the sample probe to feed through this slot.

The sealing ring should be positioned directly over the ridge surrounding the sample block area with the Bio-Rad logo towards the back of the instrument.

The sealing ring is required for optimal performance in the 60-well block. Although not required for the 96-well system, it is highly recommended to prevent tube deformation and minimize ambient condensation that can build up in humid environments after long hold times (24+ hours) at 4°C.

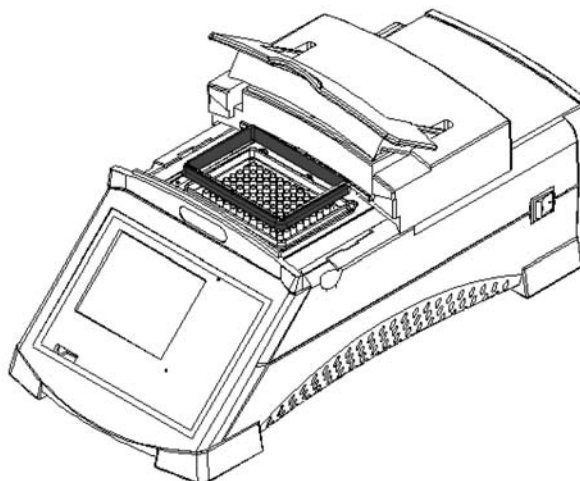

**Fig. 1.5. Use of Thermal Sealing Ring.**

When using the 96-well system without the sealing ring, please observe the following loading pattern (Figure 1.6) to insure that tubes are not deformed when the lid is closed.

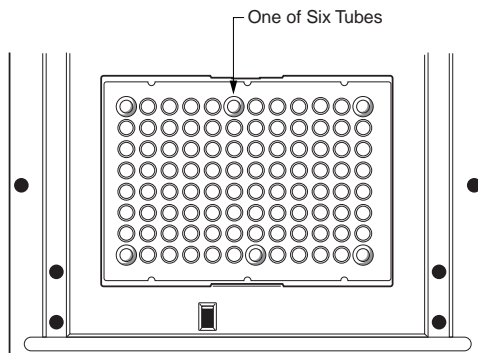

**1 x 96 Reaction Module**

**Fig. 1.6. To prevent tube deformation.**

1. Lift the handle of the reaction module and slide the lid toward the rear of the instrument.
2. Load your plate or tubes into the reaction block.
3. Slide the lid forward over the reaction block and lower the handle. Make sure that the handle closes securely over the lip of the baffle on the front of the reaction module (Figure 1.7).

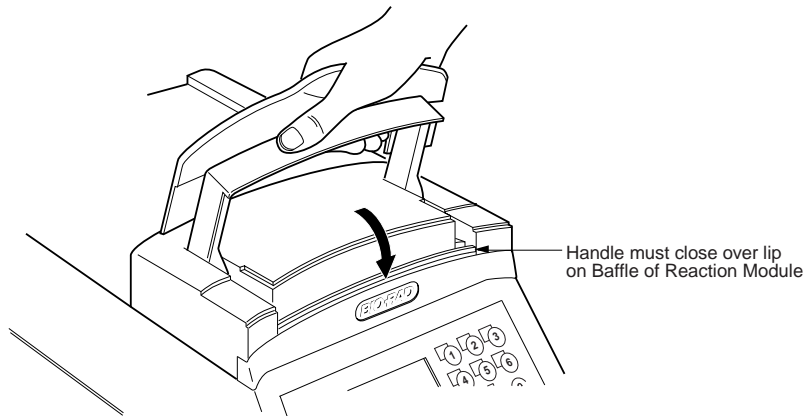

Fig. 1.7. Closing the iCycler Lid.

## 1.5 iCycler Keypad

The iCycler keypad has 25 keys on the front panel (Figure 1.8). These keys are described in the following table.

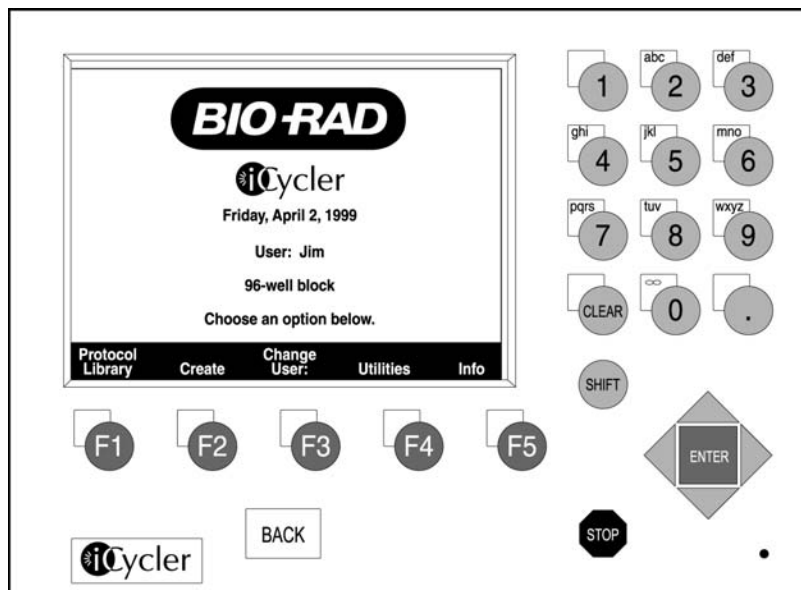

Fig. 1.8. iCycler keypad.

**Table 1. Front Panel Controls**

<b>Key(s)</b>	<b>Description</b>
<b>Softkeys F1-F5</b>	<p>The five function keys (referred to as "softkeys") are labeled <b>F1</b> through <b>F5</b>. These keys are used to navigate through the software screens and make selections in the screen displays. The operations associated with these keys are displayed in inverse video immediately above the softkey. These operations change as the display changes. For example, in the <b>Home</b> screen, the <b>F1</b> softkey will take you to the <b>Protocol Library</b>, and the <b>F2</b> softkey will enable you to <b>Create</b> a protocol.</p>
<b>BACK</b>	<p>The <b>Back</b> key will return you to the immediately previous screen or, depending on the context, to some other, more appropriate previous screen. From most places in the firmware you can repeatedly press <b>Back</b> until, eventually, you return to the <b>Home</b> screen. When the <b>Home</b> screen is displayed, the <b>Back</b> key has no further function.</p> <p>When menus or option boxes are presented, <b>Back</b> acts as a Cancel key.</p>
<b>Alphanumeric</b>	<p>To the right of the display are ten alphanumeric keys (keys 0–9), which are arranged like the keys on a telephone. Each numeric key (except 1 and 0) is used to represent three or more letters.</p> <p>The alphanumeric keys are usually used as number keys for the entry of time, temperature, and cycle repeats.</p> <p>When entering a user, folder, or protocol name into a screen display, the keys automatically shift to alpha mode for the entry of letters. The word ALPHA is displayed in the top right corner of the screen. You can toggle between alpha and numeric by pressing the <b>SHIFT</b> key. To enter uppercase letters, press <b>F2-Caps Lock</b> before pressing the alphanumeric key.</p> <p>To specify an alphabetic character, press the key until the desired character is displayed. For example, the <b>2</b> key is used for a, b or c entries. To input the letter a, press the <b>2</b> key once. To input b, press the <b>2</b> key twice and to input c, press the <b>2</b> key three times. If the <b>2</b> key is pressed a fourth time, it will display the letter a.</p>
<b>DECIMAL POINT (.)</b>	<p>When entering numeric decimal values, press this key to enter values after the decimal.</p>
<b>INFINITY</b>	<p>The <b>0</b> key is labeled with an infinity symbol above the 0 to indicate that it has a secondary function of Infinite Dwell Time. Like the alphabetic characters, this secondary function is accessed by first pressing the <b>SHIFT</b> key. The Infinity key is used to indicate dwell times that are to be terminated by user intervention.</p> <p>Typically this feature is used at the end of a protocol, but it can be used at other points as well. When an infinite dwell time is specified, the iCycler will pause the protocol at the selected temperature until you terminate or resume execution. This is discussed further in Section 4, <b>Running Protocols</b>.</p>

Key(s)	Description
CLEAR	The <b>Clear</b> key is used to clear the entry in an input field. For example, if you have specified an incorrect duration for a step, pressing the <b>Clear</b> key erases the entire entry, not just the last character entered.
SHIFT	<p>The <b>SHIFT</b> key is located below the alphanumeric keys. If you press the <b>SHIFT</b> key, the definitions of the softkeys will change. The <b>F1</b> softkey becomes the Home key and pressing it will take you immediately to the <b>Home</b> screen. The <b>F2</b> key returns you to the <b>Run</b> screen. The softkeys can be returned to their primary definitions by pressing the <b>SHIFT</b> key a second time.</p> <p>The <b>SHIFT</b> key is also used in conjunction with the number keys to switch between alphabetic and numeric character entry (see the discussion above for the alphanumeric keys), when naming a user, folder, or protocol.</p>
Directional Arrow <, >, ^, v	<p>The four Directional Arrow keys surround the Enter key and direct the cursor when navigating the screen. Normally the right and left arrows are used to move from field to field, not within a field. The exception is the case when you are assigning a folder, protocol or user name using the alphabetic keys: in this instance the right and left arrows move the cursor within the name field and the only way to move out of the field is with the <b>ENTER</b> key.</p> <p>The up and down arrows are used to move the cursor from line to line within selection boxes, or from one line to the next when editing or creating protocols. In some of the <b>Utilities</b> screens, documented in Section 5, the up and down arrows are used to set the time, date, and default conditions. When a time or temperature field has a default value and that field is highlighted, pushing an arrow key is an implied <b>ENTER</b>, accepting the default entry.</p>
ENTER	In the middle of the arrow keys is the <b>ENTER</b> key. When you press <b>ENTER</b> the current selection or input field is accepted.
STOP	Below and to the left of the <b>ENTER</b> and arrow keys is the <b>STOP</b> key. If the <b>STOP</b> key is pressed while a protocol is being executed, a currently running protocol will be paused (as described in Section 4).



## 1.6 System Accessories and Options

There are four reaction modules available for use with the iCycler:

- Reaction module: 1 x 96 well block for 0.2 ml tubes, strips, or plate.
- Reaction module: 2 x 48 well block for 0.2 ml tubes, strips, or plate.
- Reaction module: 1 x 60 well block for 0.5 ml tubes.
- Reaction module: 1 x 384 well block for plates.

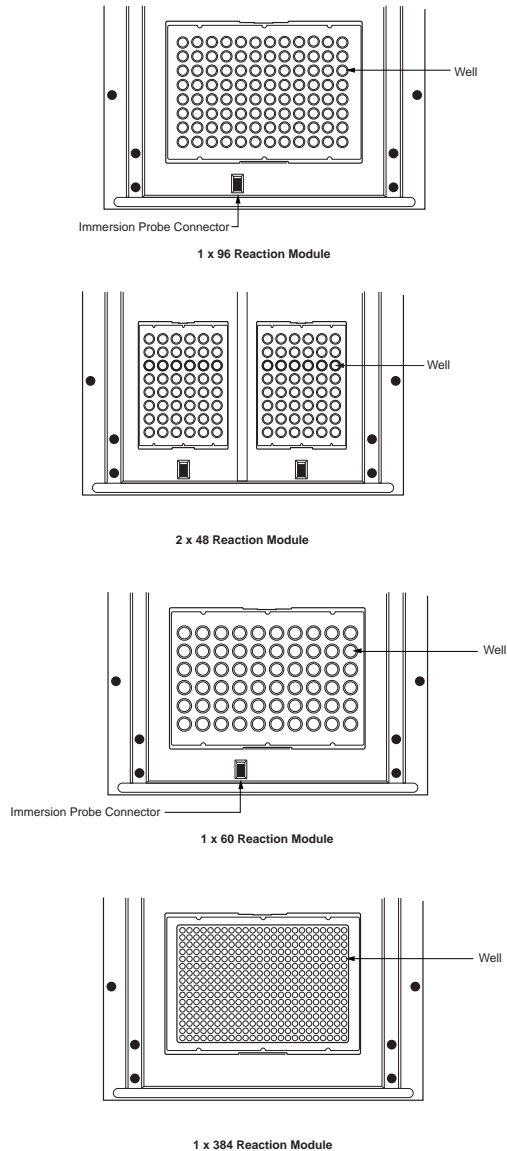

Fig. 1.8. Examples of reaction modules.

## 1.7 What's in This Manual

This manual is organized into the following sections.

- **Section 2, Logging On:** This chapter describes how to log on, create a new User, and change user information.
- **Section 3, Creating and Editing Protocols:** This chapter explains the structure of protocols and how to use the Protocol Library and other screens to create, view, and edit protocols. Examples are given.
- **Section 4, Running Protocols:** This chapter provides instructions on how to run any protocol. This includes a number of options for controlling the execution and getting reports.
- **Section 5, Utilities:** This chapter describes the features of the Utilities screen. This screen supports a number of features for customizing the environment.
- **Section 6, Care and Maintenance:** This chapter provides information on cleaning the unit, replacing fuses, a troubleshooting guide and a list of error messages.
- **Appendix A, Specifications:** This appendix provides the iCycler system specifications.
- **Appendix B, Warranty:** This appendix includes the iCycler warranty and technical support information.
- **Appendix C, Product Information.**

## Section 2 Logging On

In order to use the iCycler, you must first log on. Once the system is powered up and the system check has been performed, the **User Logon** screen is displayed (see Figure 2.1). Two options are displayed:

- **Registered User.** Select this option if you have previously registered as a user. Refer to Section 2.1.2, Logging on as a Registered User.
- **New User:** Select this option if you are a first-time user. Refer to Section 2.1.1, Creating a New User.

The maximum number of registered users is 32.

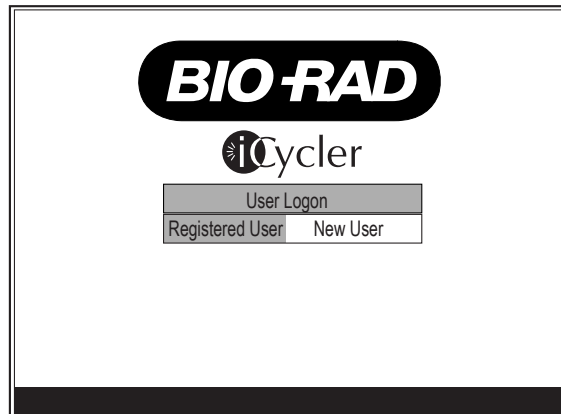

Fig. 2.1. Logon screen.

## 2.1 User Names and Information

### 2.1.1 Creating a New User

If you are a first-time user, you will need to create a user name and may create an optional **Personal Identification Number (PIN)**. A PIN is useful to ensure that only authorized personnel can make modifications to your protocol or user information. PIN protection is at the user level, not the individual protocol file level, so that each user will have only one PIN. If you choose to protect your files, then only you can delete, overwrite or move them. A protected file may be run, copied, viewed or edited by any user, though after editing the file, it can only be saved under a different name. PINs may be changed at any time (see Section 5, Utilities.) PINs expire if the user does not log after 30 days. In this way users who are no longer in the laboratory do not permanently occupy space on the iCycler. It is not possible to change the date forward to cause a PIN to expire.

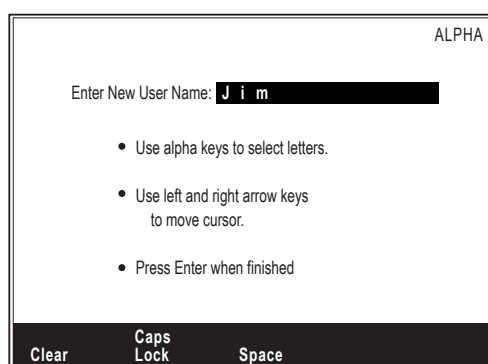

Fig. 2.2. New user screen.

1. Press the right arrow key to highlight **New User** and press **Enter**.
2. Use the alphabetic keys to input your name and press **Enter**.
  - To move the cursor: The cursor moves automatically to the next field when you press another key. If you need to use the same key consecutively, (e.g., to enter an 'a' after a 'b'), press the right arrow key to move the cursor.
  - To clear the contents of the name field: Press **F1-Clear** or press the **Clear** key.
  - To enter capital letters: Press **F2-Caps Lock**.
  - To enter a space: Press **F3-Space**.
  - To enter a number: Press the **Shift** key.
3. The PIN option screen is displayed next with the choices of **No PIN** and **Use PIN**.
  - If you do not want to have PIN protection of your protocol files:
    - a. Verify that the **No PIN** option is highlighted.
    - b. Press **Enter**. The **Home** screen will be displayed. The **Home** screen is documented at the end of this chapter.
  - If you do want PIN protection of your protocol files:
    - a. Press the right arrow key to highlight **Use PIN** and press **Enter**.
    - b. **Enter** your 1-12 digit PIN in the first box and press **Enter**.
    - c. **Enter** the same PIN in the Confirmation box and press **Enter**. The **Home** screen will be displayed. The **Home** screen is documented at the end of this section.

### 2.1.2 Logging on as a Registered User

If you have previously registered as a User,

1. Verify that the **Registered User** option is highlighted.
2. Press **Enter** and the iCycler will display the list of user names.
3. Use the up and down arrow keys to highlight your name and press **Enter**.
4. If you have PIN protection of your protocols, use the number keys to input your PIN and press **Enter**. The **Home** screen will be displayed (see Figure 2.3.)

### 2.1.3 Changing the Current User

To log on as a different user, select the **Change User** softkey in the **Home** screen (see Figure 2.3). The User Logon screen will be displayed (see Figure 2.1), allowing you to log on as a registered or new user.

### 2.1.4 Deleting a User

1. In the protocol library, highlight the user to be deleted and press Enter. Note: the user folder must be empty before the user may be deleted.
2. Choose Delete user.
3. Confirm the choice to delete the user and press Enter.

## 2.2 Home Screen

The **Home** screen is the first screen that appears after logging on to the iCycler. It consists of the iCycler logo, date, and user name. You can return to the **Home** screen at any time by pressing the **Shift** key followed by the **F1** (Home) softkey. Alternatively, you can cycle back by repeatedly pressing the **Back** key.

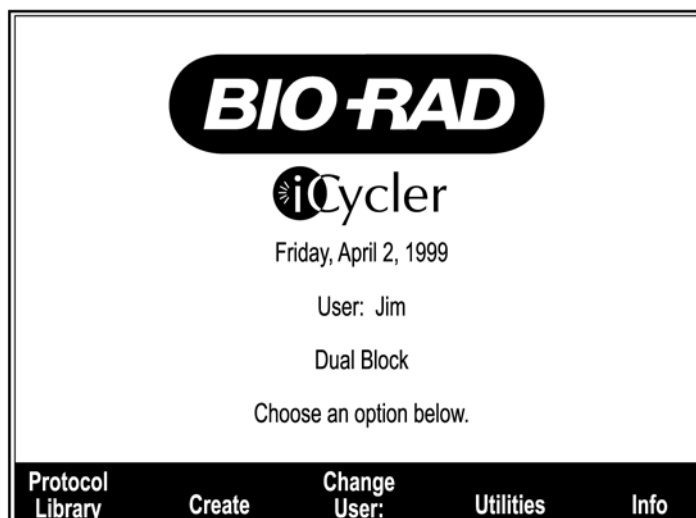

Fig. 2.3. Home screen.

The Home screen allows you to move to nearly all features of the iCycler by using the softkeys, F1 through F5. The following table describes the functionality associated with each softkey.

<b>Softkey</b>	<b>Option</b>	<b>Description</b>
F1	Protocol Library	Displays the <b>Protocol Library</b> screen documented in Sections 3 and 4.
F2	Create	Allows you to create a new protocol as documented in Section 3.
F3	Change User	Enables you to change the current user as documented in Section 2.1.3
F4	Utilities	Displays the <b>Utilities</b> screen, (Section 5), used to customize the iCycler environment.
F5	Info	Displays useful information on the iCycler. By pressing the <b>Next</b> and <b>Previous</b> softkeys, you can scroll through the information screens.

## 2.3 Quick Start Procedure

The following procedure is provided for the user wishing to immediately begin using the iCycler. Detailed discussion of the use of the instrument is provided in subsequent chapters.

1. Power up the iCycler using the power switch on the right rear of the instrument. After a quick diagnostic routine, the User Logon screen is displayed.
2. If you are a registered user, press the **Enter** key and select your name from the user list. If you are **not** a registered user, use the right arrow key to highlight **New User** and press the **Enter** key.
  - a. Input your name using the alphanumeric keypad.
    - You may need to use the right arrow key to enter a letter if the previous letter was on the same number key.
    - You may enter capital letters and/or add a space to your name by selecting the appropriately labeled softkey.
    - You may enter numbers in your name by pressing the **Shift** key.
  - b. When your name is complete, press the **Enter** key.
3. Personal Identification Number (PIN) protection (optional).
  - If you have a PIN number, enter it.
  - If you are a new user, you may choose a PIN number to protect your protocol files.
4. Run the protocol. When using the 2 x 48 x 0.2 ml reaction module, allow 10 minutes before initiating a protocol.
  - a. From the Home screen, press **F1-Protocol Library**.
  - b. Use the arrow keys to highlight the desired protocol.
  - c. Press the **Enter** key and from the selection menu, choose **Run Protocol**.
  - d. If using the 2 x 48 reaction module, select the left block or right block.
  - e. Confirm the selections in the Run Setup screen.
  - f. Press **F5-Begin Run** to run the protocol.

**Note:** You can jump between the Run screen and the Home screen by pressing the **Shift** key and then pressing **F1-Home Screen** or **F2-Run Screen**. For the 2 x 48 reaction module, you can shift between the left block run screen and the right block run screen by pressing **F1-Switch Blocks**.

### 2.3.1 Editing a Protocol

To edit a stored protocol:

1. From the Home screen, press **F1-Protocol Library**.
2. Use the arrow keys to highlight the desired protocol and press the **Enter** key.
3. From the selection menu, choose **Edit Protocol**.
4. Change the desired editable field.
  - To add or delete a step or cycle, press **F4-Add/Del**.
  - To choose an increment or decrement of time or temperature, put the cursor on the desired time or temperature field and press **F3-Option**.
  - To program a gradient, put the cursor on the temperature field and press **F3-Option**.
  - To set the ramp time or ramp rate, place the cursor on the temperature to which you are ramping and press **F3-Option**.
5. When you are finished editing the protocol, press **F5-Done**.
  - You may choose to run the edited protocol without saving the edits by choosing **Run Protocol** from the selection menu.
  - You may choose to save the edits prior to running the protocol by choosing **Save Protocol** or **Save Protocol As...** from the selection menu. Once you've saved the protocol, you may choose **Run Protocol** from the selection menu.

### 2.3.2 Creating a Protocol

To create a protocol:

1. From the Home screen, press **F2-Create**.
2. Use the arrow key to highlight **Custom** in the selection menu.
3. Edit the fields for your protocol.
  - To add or delete a step or cycle, press **F4-Add/Del**.
  - To choose an increment or decrement of time or temperature, put the cursor on the desired time or temperature field and press **F3-Option**.
  - To program a gradient, put the cursor on the temperature field and press **F3-Option**.
  - To set the ramp time or ramp rate, place the cursor on the temperature to which you are ramping and press **F3-Option**.
4. When you are finished editing the protocol, press **F5-Done**.
  - You may choose to run the edited protocol without saving the edits by choosing **Run Protocol** from the selection menu.
  - You may choose to save the edits prior to running the protocol by choosing **Save Protocol** or **Save Protocol As...** from the selection menu. Once you've saved the protocol, you may choose **Run Protocol** from the selection menu.

## Section 3 Thermal Cycling Protocols

### 3.1 Overview

Protocol files contain the information necessary to direct the operation of the iCycler. A protocol is made up of as many as nine **cycles**, and a cycle is made up of as many as nine **steps**. A step is defined by specifying a **setpoint** temperature and the **dwll time** at that temperature. A cycle is defined by specifying the times and temperatures for all steps and the number of times the cycle is repeated.

To create, view, or edit a protocol use either of the following softkeys:

- **Protocol Library:** This lists all existing protocols. The Protocol Library screen lists protocols according to user name and the folders each user has created to store those protocols. In addition, Bio-Rad has supplied a number of predefined protocols (templates) under the <Bio-Rad> user name. From the Protocol Library, you can modify an existing protocol or create a protocol by starting from a similar existing protocol. Refer to Section 3.5.
- **Create:** This lists Bio-Rad and custom template protocols, which may be used to create a new protocol. Refer to Section 3.5. The custom template is not available from the Protocol Library.

### 3.2 Protocol Display

Protocols are displayed when they are being created, viewed and edited. They are displayed on the screen in two parts: the bottom of the screen is a text description of the protocol and the top of the screen is a graphical representation of the thermal cycling protocol.

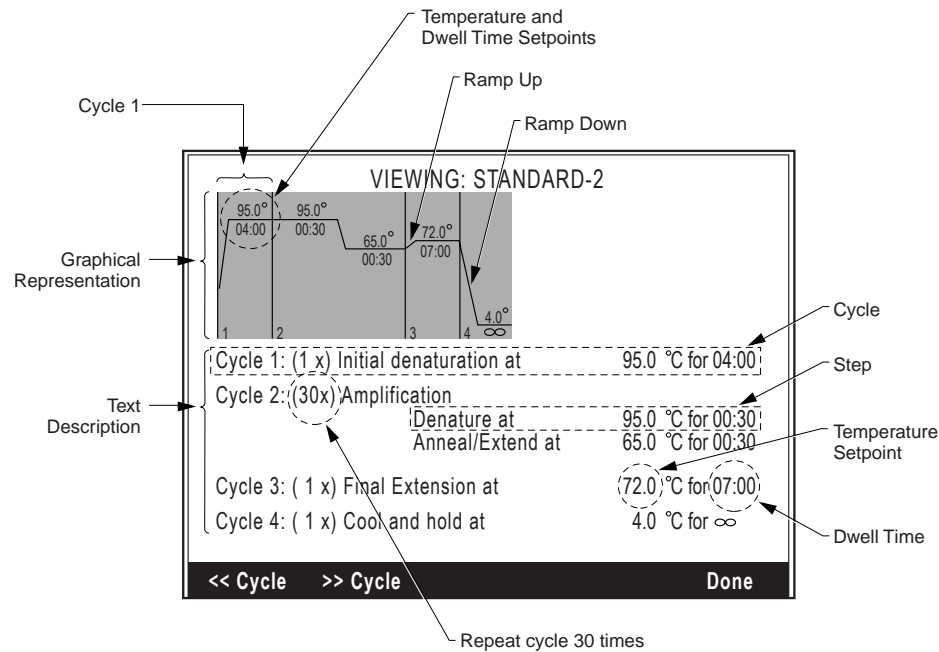

Fig. 3.1. Layout of a protocol.

### 3.2.1 Text Description

In all user-created protocols, the cycles are named Cycle 1, Cycle 2, etc. and the individual steps are named Step 1, Step 2, etc. The protocols in the Bio-Rad folder have descriptive names for the cycles and steps. For example, the first cycle in most Bio-Rad protocols is called Initial Denaturation, and in the Amplification Cycle the individual steps are named Denature, Anneal and Extend.

Each cycle has a field to set the number of times that cycle is repeated. Each step is shown on a different line and has a field for setpoint temperature and dwell time. Text descriptions of advanced options like time increment/decrement are displayed on a line below the step that they affect. In the **Create** and **Edit** screens (creating a custom protocol or editing an existing protocol), the variable fields are underlined and the field with the cursor (the field being edited) is shown in inverse video.

Some protocols are so lengthy that the entire text cannot be displayed at once. Softkeys and the arrow keys are used to navigate through these protocols. In the **View** screen,

- Press **F2-->>Cycle** or the **Enter** key to advance the text display one cycle,
- Press **F1--<<Cycle** to reverse the text display one cycle,
- Press the up arrow to advance the text display one step,
- Press the down arrow to reverse the text display one step.

In the **Create** and **Edit** screens,

- Press **F2-->>Cycle** to advance the cursor to the first field of the next cycle,
- Press **F1--<<Cycle** to move the cursor to the first field of the previous cycle.
- Use the right and left arrows to move the cursor from field to field.
- Use the up and down arrows to move the cursor between lines.
- Press the **Enter** key to advance the cursor one field to the right.

### 3.2.2 Graphical Representation

The graphical representation of a protocol shows a plot of the temperature cycling program. The plot is subdivided into separate regions for each cycle; the regions are separated by vertical bars on the plot and are numbered. At each step, the **setpoint** temperature and **dwell time** are shown above and below the line, respectively.

In the **Create** and **Edit** screens, the graph of the step currently being edited is displayed in inverse video, while steps with matching text on the screen are shown with a shaded background, and cycles with matching text not presently displayed on the screen are shown with a normal background. In the **View** screen, the graphs for cycles with matching text displayed on the screen are shown with a shaded background, and the cycles with matching text not presently displayed are shown with a normal background. As the cursor moves through the text part of the screen, the background shading of the graphical display changes accordingly.



## 3.3 Protocol Parameters

### 3.3.1 Temperature and Dwell Time Ranges

Temperatures between 4.0 and 100.0°C may be entered for any setpoint temperature. Finite dwell times may be as long as 99 minutes and 59 seconds (99:59) or as short as 1 second (00:01.)

- **Zero Dwell Times.** When the dwell time is set to 00:00, the iCycler will heat or cool until it attains the setpoint temperature and then immediately begin heating or cooling to the next setpoint temperature.
- **Infinite Dwell Times.** When a cycle is not repeated, the dwell time at any step in that cycle may be specified as infinite by using the **Shift** and then **0** keys. This means that the instrument will maintain the specified temperature until you interrupt execution. When an infinite dwell time is programmed within a protocol at some step other than the last step, the instrument will go into Pause mode when it reaches that step and will hold that setpoint temperature until the user presses **F4-Resume**.
- **Dwell Time Temperature Offset.** The dwell time temperature offset is the difference between the setpoint temperature and the actual temperature at which the dwell time begins to decrement from its setpoint to 00:00. By default this temperature offset is 1.0°C. For example, if the setpoint of step 1 is 95.0°C, the dwell time will begin counting down once the monitored temperature is 94.0°C. This temperature offset may be modified by the user (see Section 5, Utilities), but may not be set less than 0.5°C.

### 3.3.2 Advanced Programming Options

The following are advanced programming options. Discussion of the use of these functions can be found in Section 3.6.

- **Ramp Rate and Ramp Time:** The ramp rate is the speed with which the iCycler changes temperatures between the steps of a cycle, or between cycles. The ramp time is the time interval over which a temperature increase or decrease is attained. The default condition is for the iCycler to adjust temperatures at the maximum ramp rate (**Max Ramp Rate**) with the minimum ramp time. The iCycler allows you to change temperatures at a fixed rate less than the maximum (**Set Ramp Rate**), or you may choose to change the temperature over a fixed time interval (**Set Ramp Time**). Ramp rates are adjustable to a tenth of a degree per second, and ramp times are adjustable to a tenth of a second. Ramp rates must fall within the allowable range for each block (see specifications for each block). Ramp times cannot result in ramp rates outside those specified above, and if they do, the ramp time will be adjusted so that it results in an allowable ramp rate.
- **Automatic Increment/Decrement of Temperature or Dwell Time Setpoints:** You may program an automatic periodic increase or decrease in the step temperature (**Increment Temp or Decrement Temp**) and/or dwell time (**Increment Time or Decrement Time**) in a repeated cycle. For example, the temperature of step 2 of cycle 1 might be set for 60°C for the first three cycles and then set to decrease by 1°C every other cycle after that (this is not the same as decreasing the temperature 0.5°C per cycle). In another example, the dwell time of step 3 of cycle 2 is set for 2 minutes for the first five cycles and then set to increase by 15 seconds each cycle after that.

Temperature increments or decrements may be as little as 0.1°C per cycle. You may make the increase or decrease as frequently as every cycle, and the increase or decrease can begin following any cycle. The temperature increment or decrement may be as large as desired, as long it does not result in temperatures which are outside the temperature limits described above.

Time increments or decrements may be as low as 0.1 second per cycle. You may make the increase or decrease as frequently as every cycle, and the increase or decrease can begin following any cycle. The time increment or decrement may be as large as desired, as long as it does not result in a dwell time in any cycle that is outside the limits described above.

- The iCycler Thermal Cycler now offers a temperature gradient option for optimization of assay conditions. The gradient feature is available when using the 96x0.2 ml sample block. Gradients may be programmed at any step of any cycle of the protocol. The gradient option allows input of a temperature gradient of 1–25 degrees in total temperature span at temperatures as low as 40°C and as high as 99°C.

Thermal Gradients in the iCycler are formed from the front to the rear of the sample block resulting in eight specific temperatures for assay optimization. This innovative design allows for evaluation of the maximum assay components at each specific temperature. Each row includes twelve wells for evaluation of assay components such as MgCl<sup>++</sup> or primer concentrations.

The temperature gradients formed by the iCycler take a non-linear yet highly reproducible shape that allows for excellent prediction of actual sample temperatures at each sample row. Extensive validation of the gradient temperatures on multiple sample reaction blocks indicate that the non linear gradient is both predictable and reproducible.

### 3.4 Protocol Library Screen

The Protocol Library screen lists all of the protocols stored by registered users or stored as Bio-Rad templates. To display the Protocol Library, press **F1-Protocol Library** from the Home screen. The cursor will be positioned in the Users list on the name of the currently registered user.

Use the arrow keys to move the cursor to another user name, or to a folder or specific protocol. If you press **Enter**, a menu of options will be presented. The menu options will differ depending on whether a user, folder, or protocol was selected. Refer to the following sections.

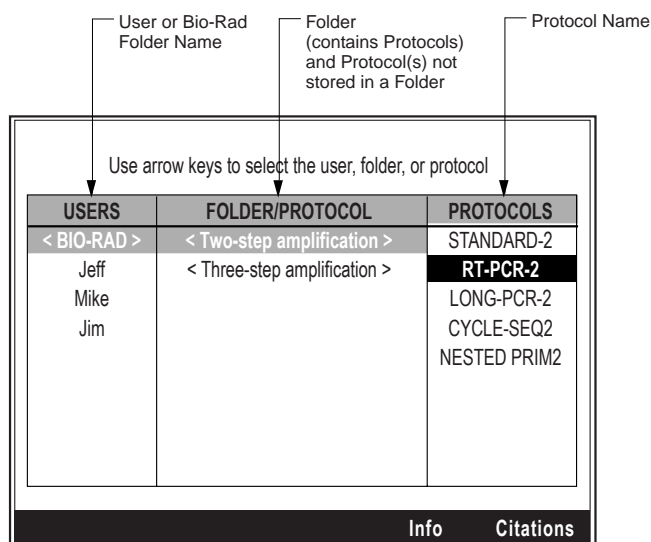

Fig. 3.2. Protocol library.

### 3.4.1 User Names and the Bio-Rad Folder

The list of registered users is displayed in the first column. By default, the current user is highlighted. To change the status of a user, select the desired user with the arrow keys, and press **Enter** to display a list of options. You may need to provide the PIN for a protected user to use these options:

- **Delete User:** You will be asked to confirm that the user should be deleted from the list of registered users. The user's folder must be empty.
- **Move User:** Use the arrow keys to move the position of the user's name in the list of registered users. Then press the **Enter** key.
- **Rename User:** You can supply a new name for a user by entering the name using the alphanumeric keypad.
- **New Folder:** To create a new folder/protocol for the user.

Once you have completed any changes, use the **Back** key to return to the Protocol Library.

The main Bio-Rad folder at the top level of the protocol library contains protocols for various PCR applications. This folder is subdivided into two folders: one containing protocols with two-step amplification cycles and one containing protocols with three-step amplification cycles. Inside both the two-temperature and the three-temperature folders are protocols for standard PCR, reverse transcriptase PCR (RT-PCR), nested primer PCR, long PCR and cycle sequencing. In addition there is a protocol for touchdown PCR in the three-temperature folder. You may not add protocols to the Bio-Rad folder, nor may you remove protocols from the Bio-Rad folder. These Bio-Rad protocols may be edited, but saving any changes will require that the protocol be saved under a new name.

### 3.4.2 Folder/Protocol Name

The middle column of the Protocol Library screen lists both folders and protocols. Folders may contain one or more protocols. Protocols are listed if they are not organized into folders. By selecting a Folder name and pressing the **Enter** key, you are presented with the following choices:

- **Delete Folder:** Folders, including the top-level User folder, may only be deleted when empty. You will be asked to confirm deletion. The default answer is No. You must use the right arrow key to highlight Yes and press **Enter** if you are sure you want to delete the selected folder.
- **Move Folder:** The Move feature can be used to change the location of a folder. The display returns to the Protocol Library screen so you may select the destination folder using the arrow keys. Press **Enter** when you are done.
- **Rename Folder:** You will be asked to enter the new name for the folder using the alphanumeric keypad. Press **Enter** when you are done. The Bio-Rad folder may not be renamed.

By selecting a protocol name and pressing the **Enter** key, you are presented with a different selection menu, as discussed in the following section.

### 3.4.3 Protocol Name

A protocol is saved as a file in a folder owned by a registered user. Protocol file names are limited to 12 alphanumeric characters. All protocol file names must be unique.

**Note:** The iCycler does not permit two stored protocol files to share the same name even if the protocol files reside in different folders. However, since protocol filenames are case-sensitive, uppercase letters may be used to distinguish protocol filenames.

After selecting a Protocol filename and pressing the **Enter** key, you are presented with the following choices:

- **Run Protocol:** The Run Setup screen is displayed as described in Section 4.
- **View Protocol:** The protocol is displayed in the View screen as described below.
- **Edit Protocol:** The protocol is brought into the Edit screen and displayed for editing. All protocols may be extensively and completely revised or edited. Editing is described in detail later in this chapter.
- **Copy Protocol:** You will first have to give the new protocol a name. Use the alphabetic keys to input a new name and press **Enter**. You can clear the name by pressing **F1-Clear**, you can choose capital letters by pressing **F2-Caps Lock** and you can enter a space by pressing **F3-Space**. After you choose the name and press **Enter**, the screen will go back to the Protocol Library screen so you can select the destination folder with the arrow keys and then press **Enter**. Protocols may not be copied into the Bio-Rad folder.
- **Delete Protocol:** You will be asked to confirm that you want to delete the selected item. The default answer is **No**. You must use the right arrow key to highlight **Yes** and press **Enter** if you are sure you want to delete the selected item. Protocols may not be deleted from the Bio-Rad folder.
- **Move Protocol:** The display returns to the Protocol Library screen so you may select the destination folder with the arrow keys, and then press **Enter**. Protocols may not be moved into or from the Bio-Rad folder.
- **Rename Protocol:** You will be asked to enter a new name with the alphanumeric keypad. After pressing **Enter**, the screen returns to the Protocol Library screen and the new name will replace the old one. Protocols in the Bio-Rad folder may not be renamed.
- **Print Protocol:** Prints a copy of the protocol if a printer is connected to the parallel port.

### 3.5 Creating and Editing Protocols

To create a new protocol press **F2-Create** from the Home screen. You will be asked to select whether you wish to:

- Create a **Custom** Protocol: This is a completely new protocol you will define. If you choose **Custom**, a simple three-step, one cycle protocol is displayed. All editing options are available through the softkeys.
- Use one of the Bio-Rad protocols as a template. Section 3.4.1 above contains a description of these protocols. You will be able to select from the individual protocols in the Bio-Rad folder. Some protocol names end with a 2 and others end with a 3; the number indicates the number of steps in the amplification cycle of that protocol. For either option you choose, you will need to enter values for time, temperature, and repeats, as described in the following sections

### 3.5.1 Specifying Time Values

Time values may fall between 1 second and 99 minutes-59 seconds. You must use the mm:ss format (e.g., 00:01 to 99:59). When you input a value, the numbers will be entered from right to left with implied zeros in the front. For example, to enter 1 minute 15 seconds, press 1, 1, 5 followed by the **Enter** or right arrow key. **Note:** entering a fifth digit will cause the left-most digit to be lost.

All protocols will have default values in each time field. If you want to accept the default value, press **Enter** or the right arrow key. The **Clear** key may be used to remove all numbers in the time field.

### 3.5.2 Specifying Temperature Values

Temperature values must be in the range of 4.0°C to 100.0°C. Numbers are displayed on the screen as the keys are touched, beginning with the position immediately to the left of the decimal point, and then they move to the left with each subsequent entry. No decimal point will be displayed until you press the decimal point key, **Enter**, or one of the arrow keys. If the decimal point key is not pressed before the **Enter** key or an arrow key, then a decimal point and 0 are appended to the temperature automatically. For example, to enter 95.0°C, press 9, then 5 and an arrow or **Enter** key. The display will show 95.0 after the last key stroke. To enter 95.5°C, press 9, 5, decimal key (.), 5. **Note:** Entering a fourth digit will cause the left-most digit to be lost. Entering a second digit after the decimal (.) will clear the first three digits in the field.

The **Clear** key may be used to remove all numbers in the temperature field.

### 3.5.3 Specifying Cycle Repeats

The number of cycle repeats may be between 1 and 600. The number of repeats is entered from right to left, similar to time and temperature values. For example, to specify 35 cycle repeats, enter 3, 5. **Note:** Entering a fourth digit will cause the left-most digit to be lost.

The **Clear** key may be used to remove all numbers in the cycle repeat field.

## 3.6 Creating and Editing Protocols: Advanced Options

When creating or editing a protocol, the system provides additional functionality in the use of the following:

- Temperature and Dwell Time Options (**F3-Option**)
- Changing the Number of Cycles or Steps (**F4-Add/Del**)

### 3.6.1 Temperature and Dwell Time Options (F3-Option)

To add periodic increments or decrements to setpoint temperatures or dwell times, put the cursor on the temperature or dwell time that you want to affect and press **F3-Option**.

- If the cursor is on a temperature field when you press **F3-Option**, a menu will offer the choices **Constant Temp**, **Increment Temp**, **Decrement Temp**, **Temp Gradient**, **Max Ramp Rate**, **Set Ramp Time**, and **Set Ramp Rate** (Figure 3.3).
- If the cursor is on a dwell time field when you press **F3-Option**, the choices in the menu are **Constant Time**, **Increment Time** and **Decrement Time**.
- If you press **F3-Option** when the cursor is somewhere other than a temperature or dwell time field, a message will be displayed advising that no options are available for this item.

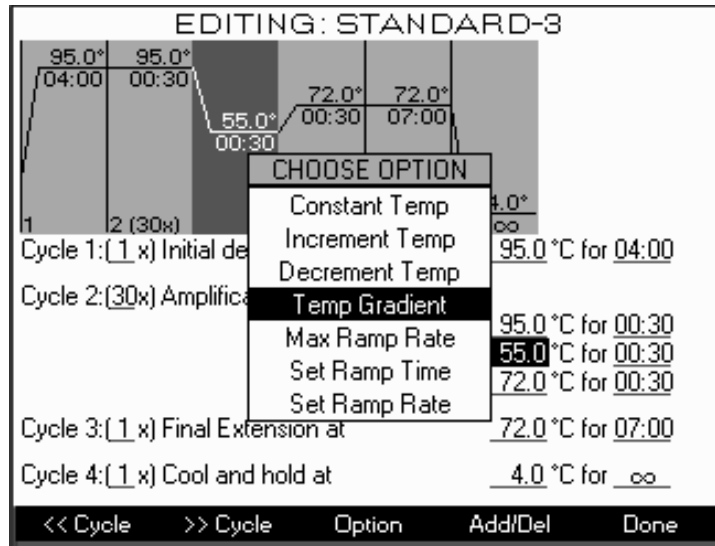

Fig. 3.3. Edit options: Setpoint temperature.

**Increment/Decrement Temperature.** When you select one of these options, a line of text will be displayed below the cursor, and that line will have three variable fields. For increment temperature, the text is:

Increase temp after cycle 1 by 0.5 °C every 1 cycles.

For decrement temperature, the text is

Decrease temp after cycle 1 by 0.5 °C every 1 cycles.

Use the number keys to change the variables in the underlined fields. Move from field to field with the right and left arrow keys, or **Enter**. You may set the increment or decrement as large as you like, as long as the combination of the increment or decrement and the number of cycles does not result in a temperature outside the range of the iCycler (4.0–100.0°C).

**Increment/Decrement Time.** These function in the same manner as Increment Temp and Decrement Temp. A line of text will be inserted below the step affected by this option. For increment time, the text is:

Increase time after cycle 1 by 00:05 every 1 cycles.

For decrement time, the text is

Decrease time after cycle 1 by 00:05 every 1 cycles.

Use the number keys to change the variables in the underlined fields. Move from field to field with the right and left arrow keys, or **Enter**. You may set the increment or decrement as large as you like, as long as the combination of the increment or decrement and the number of cycles does not result in a dwell time outside the range of the iCycler (00:00–99:59).

**Constant Temp/Time.** All optional features are reversible. To cancel a periodic increment or decrement to a step temperature, place the cursor on the temperature field or place it on any of the three fields in the text description of the increment or decrement and press **F3-Option**, then choose **Constant Temp** from the list box. Similarly, to cancel a periodic increment or decrement to a dwell time, place the cursor on the dwell time field or place it on any of the three fields in the text description of the increment or decrement and press **F3-Option**, then select **Constant Time** from the list box. The setpoint temperature or dwell time will be made constant and the text description of the increment or decrement will be removed.

**Set Ramp Time/Rate.** To set the Ramp Time or Ramp Rate, put the cursor on the temperature to which you wish to ramp and press **F3-Option**. A line of text will be inserted below the line where the cursor is located. For **Set Ramp Time** the text is:

Ramp to xx.x°C over time 01:00, where xx.x is the setpoint temperature.

For **Set Ramp Rate** the text is:

Ramp to xx.x°C at 0.1°C/sec.

You can enter a ramp rate anywhere in the allowable range for your Reaction Module type ( see specifications). You can enter ramp times that result in ramp rates in these ranges.

**Max Ramp Rate.** To return the ramp rate to the default setting of the maximum rate with the minimum ramp time, put the cursor on the temperature field or on the ramp time or ramp rate field and press **F3-option**, then select **Max Ramp Rate** from the list box. The text description will be deleted.

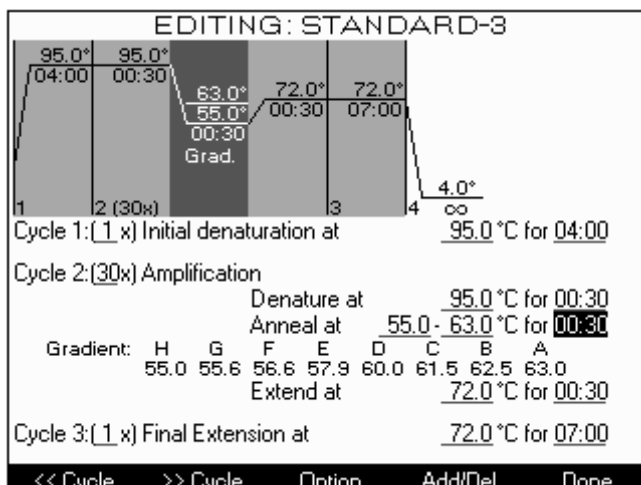

Fig. 3.4. Editing Protocol: Display of Gradient Temperatures.

### 3.6.2 Programming a Temperature Gradient (F3-Option)

To add a temperature gradient in your 96-well reaction module, to your set-point temperatures, put the cursor on the desired temperature step of the protocol and press **F3-option**.

- From the the menu, select **Temp Gradient**.
- Once selected, a default value of 10°C minimum-maximum gradient will be displayed. Input the desired range of the temperature gradient. The display will be updated with the temperatures for each row of samples (Figure 3.4). These values will be recorded in the run and validation reports (see Section 4.3). **Note:** The minimum gradient is 1.0°C; the maximum gradient is 25°C. The lowest available temperature within any gradient is 40°C; the highest allowable temperature within any gradient is 99°C.

- If the first temperature is higher than the second temperature, an error message will appear. The second temperature will be corrected to the nearest acceptable value. In addition, any input temperature out of the range of the acceptable values for gradient will be corrected to the nearest acceptable value.

### 3.6.3 Changing the Number of Cycles or Steps (F4-Add/Del)

The **Add/Del** softkey (F4) allows you to change the number of cycles or steps. When **F4** is pressed, a menu of editing choices is displayed: **Add cycle before**, **Add cycle after**, **Add step before**, **Add step after**, **Delete step** and **Delete cycle**. Steps and cycles are added before or after, relative to the current cursor position. If **Delete step** or **Delete cycle** is chosen, the step with the cursor, or cycle with the cursor, is deleted.

## 3.7 Completing Protocols

When you have finished editing the protocol, press **F5-Done** to display a menu of options. The choices are:

- **Run protocol:** To run the protocol immediately, without first saving it. The Run Setup screen is displayed. This is documented in Section 4.
- **Save protocol:** To save editing changes to an existing protocol.
- **Save Protocol as..**, You will be asked to first create a name for the protocol and then choose a destination folder. After you choose the destination folder you may initiate the protocol by choosing **Run protocol**, or you can press **Cancel** to go back to the Home screen.
- **Abandon Edits:** You will return to the **Home** screen without saving changes.
- **Print protocol:** If a printer is connected to the parallel port of the iCycler, you can print a copy of the complete protocol. After the protocol is printed, the menu will be displayed again. Choose one of the options or press **Cancel** to return to the Home screen.
- **Resume Editing:** Allows you to return to the protocol edit screen to make further changes.

The iCycler can store up to 256 different protocol files in its on-board memory. File management is provided in the Protocol Library screen (refer to Section 3.4). The information stored in a protocol file will consist of:

- the time and temperature for each step of every cycle,
- any gradient or automatic increment or decrement to the time or temperature for each step of every repeated cycle
- the ramp rate between steps within or between cycles, and the number of times each cycle is repeated.



## Section 4 Running Protocols

### 4.1 How to Run a Protocol

To run a stored protocol:

1. From the Home screen press **F1-Protocol** to display the Protocol Library.
2. Use the arrow keys to highlight the desired protocol.
3. Press **Enter** and from the selection box, choose **Run Protocol** and press **Enter**.
4. Confirm the selections in the Run Setup screen (hot start conditions, temperature measurement method, and any linked protocols) and press **F5-Begin Run** to Run Protocol. The Run Setup screen is documented below in Setting Up a Run.



**Note:** Do not remove a reaction module while the unit is running.

This symbol on the reaction module indicates a hot surface. The reaction module sample block may be hot to the touch while the unit is running.

#### 4.1.1 Run Setup Screen

When running a protocol with the 2 x 48 well reaction module, the block choice is provided (Figure 4.1). Once selected, the Run Setup screen will appear (Figure 4.2).

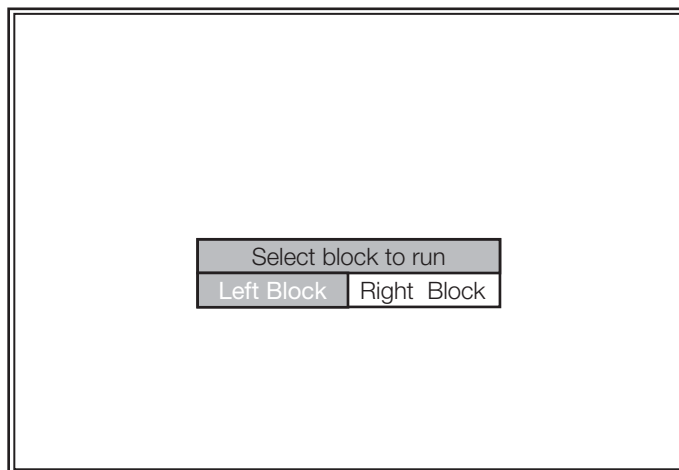
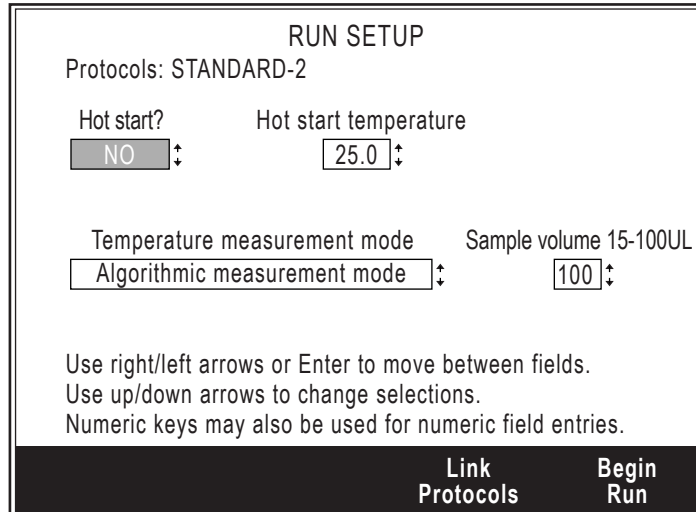

Fig. 4.1. Block Selection window for the 2 x 48 well Reaction Module.



**Fig. 4.2. Run Setup Screen.**

In this screen you can choose to specify

- **Hot Start and the Hot start temperature:** If Hot Start is chosen the iCycler will heat to the hot start temperature when the run is initiated and then go into Pause mode (see Section 4.2.4).
- **Temperature measurement mode:** The choice of method for monitoring the temperature of the iCycler depends on the type of reaction module in place. For the 96 x 0.2 ml, 60 x 0.5 ml and 2 x 48 x 0.2 ml reaction modules, the temperature of the block or of the sample may be monitored. The sample may be monitored either by a sample probe (96 x 0.2 ml and 60 x 0.5 ml) or by an algorithm specific for that block and the volume of sample. The 384-well reaction module allows only algorithmic measurement. When the gradient feature of the 96 x 0.2 block is used, only the block and algorithm methods are available. If you choose the sample probe mode when a gradient is programmed, you will see an error message.
- **F4-Link protocols:** You may link up to four additional protocols that will be executed in order after completion of the first protocol. If you indicate that you wish to link to another protocol (**F4-Add Link**), the Protocol Library will be displayed. Highlight the name of the desired protocol and press the **Enter** key. You then have the option to View the protocol before you link it. Press **F4-Add Link** or the **Enter** key to add the link. After you view a protocol, press **F5-Done** and the same menu will be displayed again. If you realize that you do not wish to link that particular protocol, press **F5-Done** and you will be returned to the Run Setup screen. Use **F3-Remove Link** to remove the last link in the list. You may continue pressing **F3-Remove Link** to remove all links.

When the Run Setup options are specified, press **F5-Begin Run**. Protocol execution will begin as soon as the lid temperature reaches 105°C.

#### 4.1.2 Running a Protocol

The Run screen will be displayed as the execution of the protocol begins (Figure 4.3). The Run screen displays the graphical representation of the protocol in the top half on the screen display, with the setpoint temperature and dwell time of each step displayed on the graph. As each step is carried out, it is shown in inverse video.

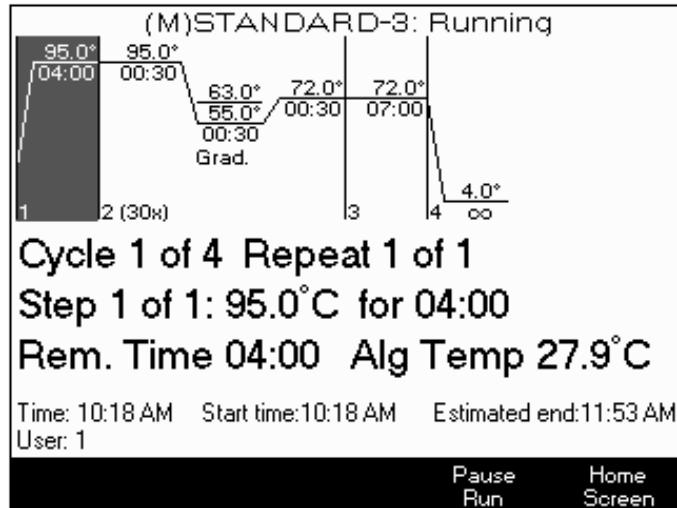

Fig. 4.3. Run screen.

The screen also shows the current actual temperature of the sample (when temperature is monitored via the temperature probe), the calculated sample temperature (when the temperature is monitored via the algorithm mode), or the reaction module block temperature (when block monitoring mode is selected).

The current cycle, step and repeat number will be displayed. The dwell time of the current step will be shown and will count down once the temperature of the sample or reaction module's block is within 1°C of the setpoint temperature or the specified offset temperature (see Section 5, Utilities).

The name of the user will be displayed along with the name of the protocol if it has been saved to memory. If the protocol is an unsaved modification of a saved protocol, then the name of the saved protocol is displayed and preceded by the letter M (for modification) in parentheses.

The current time of day will be displayed along with the time the protocol was initiated, and with an estimated time of completion.

The status message of the left and right blocks for the 2 x 48 well reaction module will flash on the top of all screens while a protocol is in progress. These messages are:

- Left Block Protocol is Running
- Right Block is Running
- Left Block is Paused
- Right Block is Paused
- Left Block Complete
- Right Block Complete
- Left Block Complete with Errors
- Right Block Complete with Errors

All other block formats will flash a status message on the upper left portion of the screen. These messages are:

- Protocol is Running
- Protocol is Paused
- Protocol Complete
- Complete with Errors

If the instrument is running a protocol that was interrupted by a power loss, the run will resume when power is restored and a message will be displayed on the Run screen indicating that power had been interrupted and show the length of that interruption. If a protocol is interrupted more than twice, then the instrument will terminate the protocol.

#### 4.1.3 Running Gradient Protocols

The temperature gradient will appear in the graphical representation of the protocol. The maximum temperature, minimum temperature, and “Grad” will be displayed for the gradient segment. This graphical presentation of the protocol appears in the run screen while the protocol is running (Figure 4.4).

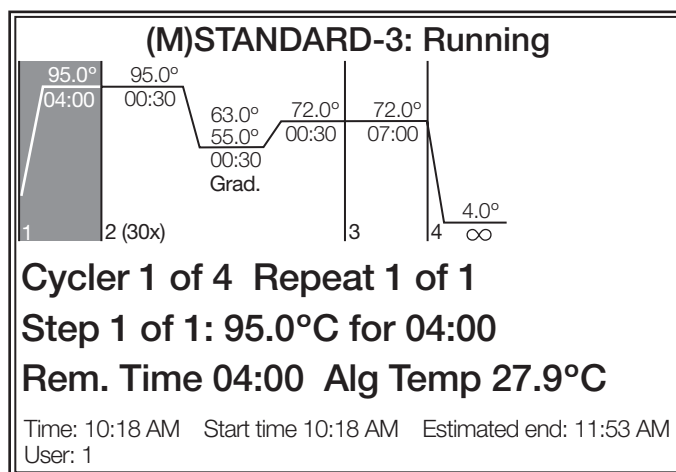

Fig. 4.4. Running Protocol: Temperature Gradient Indicated.

## 4.2 Options While a Protocol is Running

### 4.2.1 Displaying the Home Screen While a Protocol is Running

In the Run screen, pressing **F5-Home Screen** does not affect execution of the current protocol. From the Home screen you will be able to perform other functions, including programming additional protocols. You may return anytime to the Run screen by pressing **Shift** and then **F2**.

### 4.2.2 Switching Between Blocks (2 x 48 Well Reaction Module)

In the Run screen, an additional function button is available for the 2 x 48 well reaction module. The **F2-Switch Blocks** will alternate between the Right and Left Block. All other function keys operate as specified.

### 4.2.3 A Power Failure While a Protocol is Running

If a running protocol is interrupted by a power failure, the iCycler will resume execution of the protocol automatically when power is restored. The protocol will resume at the highest-temperature step of the cycle that was interrupted, and a message will be displayed on the Run screen describing the length of the interruption. The Validation and Run reports will both include a description of the power interruption.

If power is lost more than twice, the iCycler will not resume execution of the protocol. If any single power interruption lasts longer than ten minutes, the protocol will not be resumed.

### 4.2.4 Pausing a Running Protocol

When the STOP key or the Pause (F4) softkey is pressed while a protocol is running the iCycler will go into Pause mode and the temperature of the reaction module block will be brought to the next setpoint temperature and held there. If the iCycler is counting down a dwell time when the STOP key is pressed, it maintains that temperature and the clock stops. The softkey options are Resume or End the running protocol. If you choose:

- **F4-Resume Run:** The clock will immediately begin counting down the dwell time or resume counting down at the point at which the protocol was paused.
- **F3-End Run:** The instrument will be heated or cooled to the idle temperature, and the iCycler will return to the Home screen.

### 4.2.5 Terminating a Running Protocol

To terminate execution of a protocol before it has been completed, go into Pause mode, as described above, and select **F3-End Run**.

### 4.2.6 End of Run Screen

The End of Run screen is automatically displayed after protocol execution (Figure 4.5). It will offer softkey options for getting reports on the protocol. These reports are discussed in the following section. If there was any problem with execution of the protocol, a message to that effect will be displayed.

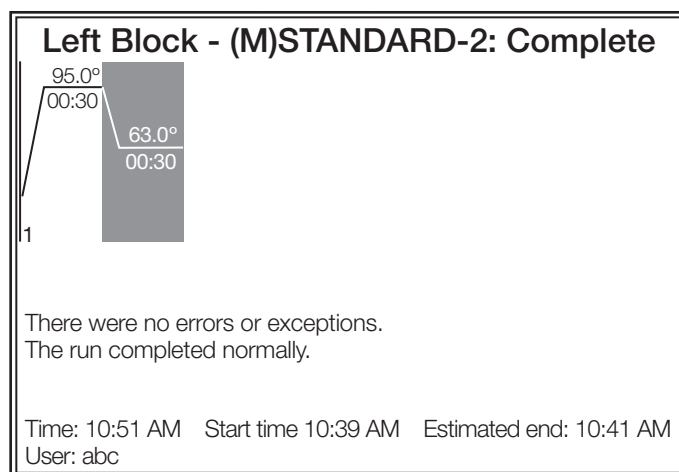

Figure 4.5. End of Run Screen.

### 4.3 Viewing Reports

The End of Run screen provides access to two reports on a completed run. Use the softkeys to choose the report you wish to view:

- Instrument Validation (\*.VAL) report
- Run (\*.RUN) report, a subset of the information contained in the Validation report.

A selected report can be displayed to the screen and then navigated with the up and down arrows, or the report can be directed to a printer. These reports are retained for 30 days and may not be deleted by any user. You may also view reports from the Utilities screen as documented in chapter 5.

**Note:** When using a printer, it is recommended that the printer be turned on after the iCycler is turned on and turned off before the iCycler.

The Run report will include the:

- User name
- Name of the protocol that was run. If the protocol is an unsaved modification of a stored protocol, the prefix (*M*), for modified, will appear before the name in parentheses.
- Date, time of start, time of finish.
- Instrument serial number
- Details of any power interruption, *e.g.*, begin time, end time, duration, which step/cycle/cycle repeat was being executed at the time and the step/cycle/cycle repeat at which the protocol was resumed.
- Type of reaction module used.
- Details of the protocol.
- Method of temperature monitoring and, if the Algorithmic method is used, the sample volume.
- Appropriate global settings, *e.g.*, temperature offset before dwell time begins counting down, maximum allowed temperature difference (from setpoint) before considered an error.
- One-line summary describing any setpoint temperature deviations or failures.
- Validation and Run report name.

The validation report provides details of all errors or exceptions by cycle, step, and repeat number.

## 4.4 Uploading Reports to the Computer

An external utility is available to upload the run and validation reports from the iCycler Thermal Cycler to a PC computer system. This utility is included on the firmware upgrade floppy diskette included with all new block releases and on the CD ROM that ships with all optical systems. You may order the firmware upgrade kit from Bio-Rad (catalog number 170-8737).

1. Use the Windows Explorer to create a new folder on the C: drive.  
Name the folder \report utility
2. If you have the CD ROM, open the CD-ROM directory \base unit\report utility and copy the file RPTUPLD.EXE to the folder \report utility.  
If you have the floppy diskette, open the diskette directory\report utility and copy the file RPTUPLD.EXE to the folder \report utility.
3. Close any other application that could already have taken control of the iCycler base unit. (ICYCLER.EXE software or UPGRADE.EXE utility)
4. From the Explorer, open the \report utility folder and double click on RPTUPLD.EXE. The utility will open.
5. Depending on what you want to load, select either validation or run report in report type.
6. Click in the left part of the screen to select the report to display. The corresponding report is displayed in the right part of the screen. (Figure 4.6)

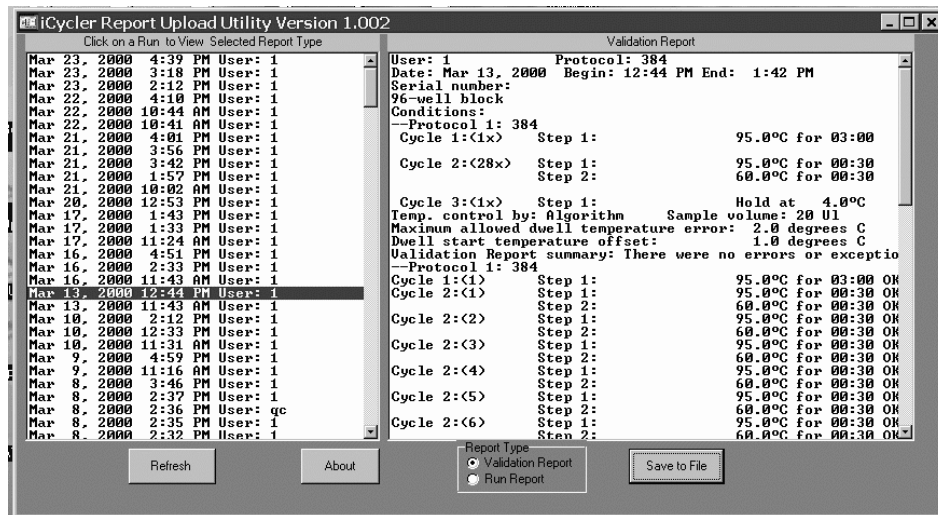

Fig. 4.6. Example Validation Report.

7. To save this report, click on the SAVE TO FILE button. Enter a valid file name in FILE NAME followed by .TXT. For instance type: REPORT1.TXT
8. Click on the SAVE button. Files are saved in plain text format and can be easily reopened and printed using a word processor such as Microsoft Notepad or Microsoft Word.

## Section 5 Utilities

The Utilities screen allows you to customize your user environment. To display the Utilities screen from the Home screen, press **F4-Utilities**.

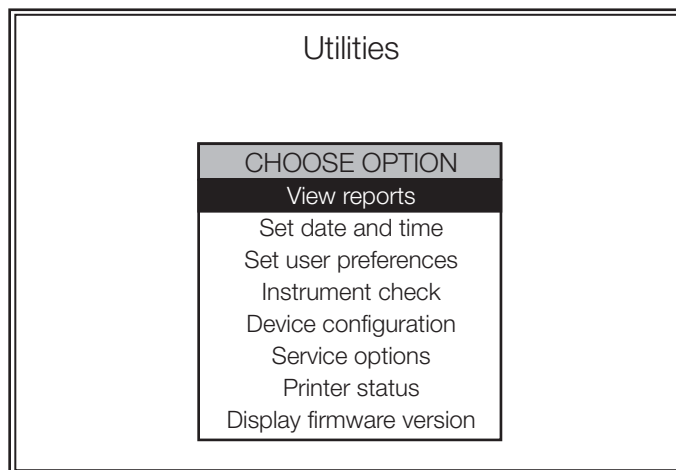

Fig. 5.1. Utilities screen.

The **Utilities** screen options are:

- **View reports:** To view the list of Run and Validation reports. These reports are stored by the system for 30 days.
- **Set date and time:** To set the current date and time.
- **Set user preferences:** To change user-specific settings.
- **Instrument check:** To perform analyses of the iCycler operation.
- **Device configuration:** To change instrument-specific settings.
- **Service options:** For Bio-Rad internal use only.
- **Printer status:** To get information on a printer connected to the instrument.
- **Display Firmware version:** To see the current firmware version.

### 5.1 View Reports

By selecting **View Reports** from the **Utilities** screen, you can get a listing of all Instrument Validation and Run reports for the last 30 days. For complete discussion of the different reports, refer to Section 4.

### 5.2 Setting the Date and Time

You can set the date and time on the iCycler by selecting **Set Date and Time** from the **Utilities** screen. Use the up and down arrow keys to select the month, day, year (4-digits), hour, minutes, and seconds. You may also choose to display the time of day in the format of 12 hours or 24 hours, *e.g.*, 3:00 PM or 15:00.



## 5.3 Setting User Preferences

When you select **Set user preferences** from the **Utilities** screen, you will be presented with a menu of features you may modify for your user environment. These are personal, not global, preferences. That is, the settings will apply only to the user account under which you have logged in.

- Beep options selection
- Change PIN (if PIN protection has been set up)
- Default hot start selection
- Hot start temperature
- Temperature measurement mode
- Default sample volume

### 5.3.1 Setting Beeper Options

If you choose Beeper options selection in the Set Preferences screen, you can customize the instrument to make a particular sound for a number of different conditions.

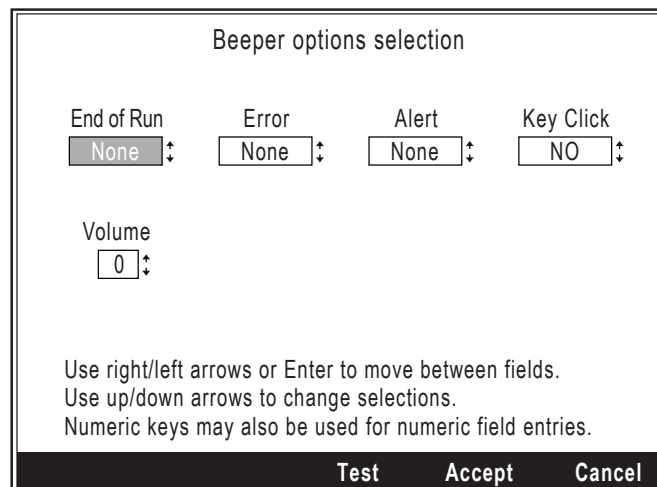

Beeper options selection

End of Run: None

Error: None

Alert: None

Key Click: NO

Volume: 0

Use right/left arrows or Enter to move between fields.  
Use up/down arrows to change selections.  
Numeric keys may also be used for numeric field entries.

Test Accept Cancel

Fig. 5.2. Beeper options screen.

- **End of Run:** Whether or not to beep at the end of a protocol
  - **Error:** To call attention to an error state. Errors and alerts may be caused by any number of conditions. For example, a machine malfunction or a problem completing a cycle.
  - **Alert:** To signify a warning
  - **Key Click:** To enable audible keypress. By default the iCycler makes a click each time a key is pressed.
  - **Volume:** To set the beeper volume.
- Once you have made the settings above, you can test or finalize the results. Select:
- **F3-Test:** To hear the beep currently selected.
  - **F4-Accept:** To use the current settings with your user account.
  - **F5-Cancel:** To ignore any changes you have made this session.

### 5.3.2 Changing PIN Options

If you enabled PIN protection, the **Change PIN** option will appear in the Set Preferences menu. This option allows you change your PIN. You must first enter the old PIN and then enter the new one twice to confirm the new value. Note that PINs expire if the user does not log for 30 days. In this way users who are no longer in the laboratory do not permanently occupy space on the iCycler. It is not possible to change the date forward to cause a PIN to expire.

### 5.3.3 Default Hot Start Selection

A hot start means that when a protocol is started the iCycler heats to the specified hot start temperature and then goes into pause mode. You may specify whether a Hot Start should be the default condition for new protocols by selecting **Default hot start selection** in the Set Preferences menu.

You can change the default value at the Run Setup screen.

### 5.3.4 Hot Start Temperature

You may specify the default Hot Start Temperature for new protocols by selecting **Hot Start Temperature** in the Set Preferences menu. You can change the default value at the Run Setup Screen.

### 5.3.5 Temperature Measurement Mode

You may choose the default temperature measurement made by selecting **Temperature measurement mode** in the Set Preferences menu. For the 96 x 0.2 ml or 60 x 0.5 ml reaction modules there are three modes to choose from:

- Algorithmic
- Block
- Sample: Sample mode requires the use of a temperature immersion probe for temperature control (See Figure 5.3). Place the immersion probe in a tube containing a volume of mineral oil equal to the volume of a sample in the other tubes. Plug the probe into the 2-pin connector at the front of the sample block. (Mineral oil is used because it does not evaporate.)

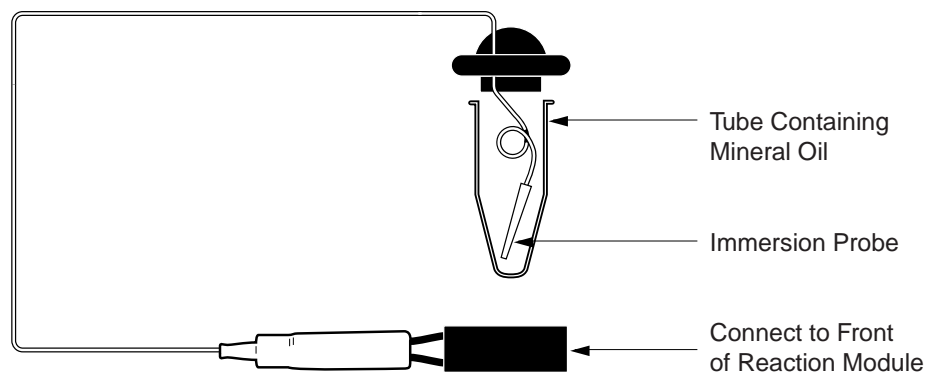

Fig. 5.3. Use of the Immersion Probe for use with sample measurement mode.

### 5.3.6 Default Sample Volume

You may set a default value for the sample volume for algorithmic temperature measurement. You may indicate the default value for new protocols by selecting **Default sample volume** in the **Set Preferences** menu. You can change the default value at the Run Setup screen.

## 5.4 Instrument Check

An instrument check option is available for the 96 x 0.2 ml, 60 x 0.5 ml, and the 384 well reaction modules. The instrument check option performs analyses on the performance of the iCycler as well as a test of the internal communications and circuitry. You can select and perform an instrument check by selecting **Instrument Check** in the **F4-Utilities** menu.

## 5.5 Device Configuration

Some features of the iCycler may be set globally. These can not be changed for individual users. If you select **Device Configuration** from the **Utilities** screen, you will be able to set values for the following:

- **Set display contrast:** The screen contrast for the LCD. Use the right and left arrow keys to raise/lower the display contrast. Contrast is measured as a value from 0 (lowest) to 255 (highest.)
- **Dwell start temperature offset:** The temperature offset at which the dwell time begins to be counted down defaults to 1.0°C. You may set a new value here.
- **Maximum dwell temperature offset:** The maximum allowable deviation from setpoint temperature (before showing up as a failure on the Run and Validation reports) will default to 2.0 °C, but can be changed here.
- **Idle temperature mode:** When the machine finishes a protocol that does not end with an infinite hold, you may choose for the iCycler to hold a user-defined idle temperature or to shut down temperature control of the block.
- **Idle holding temperature:** The temperature of the iCycler when it is in Idle mode.
- **Lid Temperature Control:** It is possible to choose a lid temperature preference for operation of the iCycler. The factory selection sets lid temperature to maximum (105°C) unless block temp is at or below 24°C. At block temp of 24°C and lower the lid temperature is set to 40°C. Two alternatives are offered: You may choose to have the lid turned off once the block reaches 24°C or lower or you may choose to turn the lid off at all times. This option must be considered carefully because the heated lid prevents condensation of PCR sample on the side and lids of the PCR vessels.
- **Printer Auto Return:** This automatically causes a carriage return insertion. This is required for proper printing with some printers.

## 5.6 Service Options

Service options are reserved for authorized Bio-Rad service personnel only.

## 5.7 Getting Printer Status

You can get detailed information on any printer attached to the iCycler by selecting the **Printer Status** option from the Utilities screen. A screen will appear telling you whether the printer is on- or off-line, and the contents of the printer buffer. Press **F1-Reset Printer** to reset the printer. Press **F3-Printer Test Page** to print a test page.

## 5.8 Display Firware Version

The current version of firmware can be displayed by selecting **Display Firmware Version** in the **F4-Utilities** menu. To determine if your version of the firmware is the most recent, you can either contact Bio-Rad Laboratories technical support or check our web site at [www.bio-rad.com](http://www.bio-rad.com).

## 5.9 Uploading New Versions of Firmware

Bio-Rad is committed to continuous improvement in iCycler features. Towards that end, the iCycler firmware will be upgraded to offer new features on a regular basis. We will make a firmware upgrade diskette available at the time of each new release and announce the release on our web site [www.bio-rad.com](http://www.bio-rad.com).

The iCycler is upgraded via a serial port connection to a PC Computer. The computer serial port must support a 57600 baud rate. The connection may be made with a standard 9 pin serial cable. The firmware upgrades may be ordered from Bio-Rad using part number 170-8737.

**Upgrading the Embedded Firmware.** The upgraded version of the firmware and a utility for loading it are on the diskette described above. First insure that the serial cable is connected and that the computer and iCycler are both powered on.

1. Log into the iCycler with a user name.
2. Create a new folder on the computer hard drive. Name the folder "Upgrade."
3. Insert the floppy disk into the drive.
4. Open the floppy disk directory and locate the Utilities folder. Open the folder called \Base Unit\Firmware Upgrade and copy the files Upgrade.exe and icycupdt.bin to the newly created Upgrade folder.
5. Open the Upgrade folder on the C drive and double click on Upgrade.exe. The utility will open and assess the current version and the new version of firmware to be downloaded. If they are the same, there is no need to proceed. If they are different and you want to proceed with the download, confirm this by selecting "yes" and the utility will automatically download the new version of the firmware over the serial port.
6. When the upgrade is complete, a message will be displayed telling you that the upgrade has been successfully completed. You must turn the iCycler off and back on to implement the new version of firmware.

## **Section 6**

### **Care and Maintenance**

#### **6.1 Cleaning the Unit**

You should ensure that no liquid is spilled onto or into the iCycler. In addition, periodically wipe it clean of dust and other residue that comes with normal operation of the instrument. Use a soft, lint-free cloth and deionized water.

#### **6.2 Replacing a Fuse or a Battery**

The fuses are located in the power entry module, just below the power connector. If the iCycler does not turn on (as indicated by its LED at the lower right of the front panel) when the power switch is turned on, then the fuses should be replaced. To replace the fuses:

1. Disconnect the power cord from the unit.
2. Remove the fuse drawer with a small-blade screwdriver or similar tool. Refer to Figure 1.3.
3. Pull the fuse holder out of the fuse drawer and, if necessary, replace the fuses with ones having the correct current rating.
  - a. For 100–120 V operation: Use 8.0 A, 5 x 20 mm, Type T fuses.
  - b. For 220 V–240 V operation: Use 4.0 A, 5 x 20 mm, Type T fuses.
4. Reinsert the fuse drawer into the power entry module. Press gently until it snaps into place.
5. Insert the power cord plug into the power entry module. Plug the power cord into a properly grounded outlet.

The battery will need to be replaced if the time and date do not remain set after the unit is turned off. The battery is a 3 V lithium coin cell (battery number CR2032; Bio-Rad catalog number 900-6020.) To replace the battery:

1. Disconnect the power cord. Remove the reaction module.
2. Turn the chassis over so that the bottom faces up. Locate the metal access panel at the bottom front. Loosen the screw and remove the panel.
3. Remove the old battery and replace it with a new battery. A small flat bladed screwdriver may be used to aid removal. The (+) battery terminal (flat side) must face outwards.
4. Reverse steps 2 and 1.

### 6.3 Troubleshooting Procedure

<b>Problem</b>	<b>Cause</b>	<b>Solution</b>
No power (front panel LED does not light)	Blown fuse in power entry module	Replace fuse
	Bad power cord	Replace cord
	Circuit tripped	Check outlet, reset breaker
Fuse blows repeatedly	Wrong line voltage setting	Move switch setting
Will not go to 4 degrees	Reaction Module not seated	Reseat
	Ambient temperature too hot	Move to a cooler location (see specifications)
Condensation on tops of tubes or plates	Lid heater failed	Call Bio-Rad
Lid heater does not work	Loose cable connection or instrument failure	Call Bio-Rad
Crushed tubes	Not enough tubes in block	Add extra empty tubes
LCD too light or dark	Poor Adjustment	Adjust as described in Section 5.4.
LCD panel blank, but fan runs	LCD failure, loose cable	Call Bio-Rad
No fan, but LCD panel on	Loose fan cable	Call Bio-Rad
	Failed fan	
Time and date are not retained when power is off	Dead battery	Replace battery. See Section 6.2.
"No Reaction Module Detected"	Reaction Module not seated properly	Reseat
"Operation Not Possible" message	Bad LED circuit	Call Bio-Rad

## 6.4 Error Messages

**Note:** When using a printer, it is recommended that the printer be turned off before the iCycler.

<b>Message</b>	<b>Cause</b>
No operations allowed for selected item. Press <b>Enter</b> key	You pressed an inappropriate key for highlighted item.
Out of range entry corrected to nearest valid value!	Time or temperature values were outside allowed ranges.
Infinite time invalid in repeated cycles	If a cycle is repeated you may not specify an infinite dwell time within that cycle.
Only nine cycles are allowed in a protocol.	
Only nine steps are allowed in a protocol cycle.	
No options available for this item.	
Note: The previous run had exceptions. Press <b>Enter</b> key	Errors were detected in execution of last protocol.
Cannot start run. Run currently in progress Press <b>Enter</b> key	A protocol is currently being executed.
Selected operation available only to item owner!	You tried to rename, or delete a PIN protected protocol, folder or user.
Folders may only be placed in the folder level!	You selected a wrong destination for a new folder. Select a user name in the first column of Protocol Library.
Only empty folders may be deleted! Press <b>Enter</b> key	
There is no available space for new folders! Press <b>Enter</b> key	Only 256 folders may be stored.
Users may only be placed in the user level! Press <b>Enter</b> key	You tried to move a user to the second or third column in the Protocol Library.

<b>Message</b>	<b>Cause</b>
There is no available space to save new protocols! Press <b>Enter</b> key	The 256-protocol storage limit has been reached.
No changes are allowed to the Bio-Rad folders! Press <b>Enter</b> key	You may not rename, move or delete protocols from the Bio-Rad folder. You may not move protocols into the Bio-Rad folder.
Selected destination available only to item owner! Press <b>Enter</b> key	You may not move folders or protocols into a PIN-protected folder.
Error: Name is blank!	You pressed <b>Enter</b> prior to naming a protocol, folder or user.
Error: Name in use. Please use a different name. Press <b>Enter</b> key	
PIN is incorrect!!	Wrong PIN was entered.
All user slots are full. You must delete an existing user before adding more.	The 32-user limit has been reached.
Entries do not match!! Press <b>Enter</b> key to retry entry.	You did not enter your new PIN number twice, or the entries were not identical.



## Appendix A Specifications

### Input Power

100–120 VAC	100–120 VAC; $\pm 10\%$ ; 50–60 Hz Fuse: 8.0 A; 5 x 20 mm; Type T
220–240 VAC	220–240 VAC; $\pm 10\%$ ; 50–60 Hz Fuse: 4.0 A; 5 x 20 mm; Type T
Power	670 Watts; 910 VA (max.) 200 Watts (typical)

### Temperature (chassis)

Operating	5–32°C
Ambient storage	-20°C to 60°C

### Temperature (reaction modules)

**Note:** the following apply only to the 96-well and 384-well reaction modules.

Range	4–100°C
Cycling speed	<b>96 x 0.2 ml Reaction Module:</b> with 20 $\mu$ l sample in a 0.2 ml tube in the 96 well module, after full warm up, when cycling between 50°C and 95°C; at least 3.3°C/sec maximum heating rate and 2.0°C/sec maximum cooling rate. <b>2 x 48 x 0.2 ml Reaction Module:</b> with 20 $\mu$ l sample in a 0.2 ml tube in the 48 well module, after full warm up, when cycling between 50°C and 95°C; at least 2.2°C/sec maximum heating rate and 1.8°C/sec maximum cooling rate. <b>60 x 0.5 ml Reaction Module:</b> with 50 $\mu$ l in a 0.6ml tube in the 60 well module at 20–25°C ambient temperature, after full warm up, when cycling between 50°C and 95°C; at least 2.0°C/sec maximum heating rate and 1.8°C/sec maximum cooling rate. <b>384 Well Reaction Module:</b> with 15 $\mu$ l in one well of a 384 well plate in the 384 well module, at 20–25 °C ambient temperature, after full warm up, when cycling between 50°C and 95°C; at least 2.0 °C/sec maximum heating rate and 1.8°C/sec maximum cooling rate.
Storage cooling	less than 3 minutes to cool from 40°C to 4°C
Overshoot	less than 0.5°C
Accuracy	$\pm 0.3^\circ\text{C}$ to NIST traceable standard after 30 seconds at 90°C, block mode
Uniformity	Well-to-well uniformity of $\pm 0.4^\circ\text{C}$ within 30 seconds after arrival at 90°C

### Temperature Gradient (96 well x 0.2 ml sample block)

Input Gradient Range	1–25°C
Functional Gradient Range	5–25°C
Minimum Temperature of Gradient	40°C
Maximum Temperature of Gradient	99°C
Gradient Accuracy	$\pm 0.4^\circ\text{C}$
Gradient Uniformity	$\pm 0.4^\circ\text{C}$

## Specifications (continued)

### Descriptive Specifications

Dimensions, Chassis (HxWxD)	23 cm x 26.4 cm x 54.6 cm; (9" x 10.4" x 21.5")
Dimensions, Reaction Module (HxWxD)	13.34 cm x 25.40 cm x 30.48 cm; (5.25" x 10" x 12")
Weight	Chassis: 6.8 kg (15 lbs) 96-well reaction module: 5.0 kg (11 lbs)
Sample capacity/ Sample Size	1 x 96-well (0.2 ml) sample block 1 x 60-well (0.5 ml) sample block 1 x 384-well sample block 2 x 48 well (0.2 ml) sample block
Display	LCD Quarter VGA screen with backlight
Chassis	Cycology ABS plastic

### Programming Specifications

No. of Programs	256 on board
Cycles/Protocol	up to 9
Steps/Cycle	up to 9
Repeats/Cycle	up to 600
Dwell Time	00:01–99:59 minutes
Pause	Yes
Built-in Protocols	Templates for cycle sequencing, Touchdown, RT PCR, nested PCR, long PCR.

### Regulatory

PCR License	Authorized Thermal Cycler <b>Note:</b> Use of the iCycler with authorized reagents also provides a limited PCR license in accordance with the label rights accompanying such reagents. Some applications may require licenses from other parties.
Safety	EN-61010, TUV approved
EC:	Compliance with EN55011 class A, EN50082-1.

### Communications

### Electrical Approvals

Serial and parallel ports  
TUV, CE

## Appendix B Warranty

The iCycler is warranted against defects in materials and workmanship. For specific Warranty information, contact your local Bio-Rad office. If any defects should occur during the warranty period, Bio-Rad will replace the defective parts without charge. However, the following defects are specifically excluded:

1. Defects caused by improper operation.
2. Repair or modifications done by anyone other than Bio-Rad Laboratories for use with the iCycler.
3. Use with tubes, plates, or sealing materials not specified by Bio-Rad Laboratories for use with the iCycler.
4. Deliberate or accidental misuse.
5. Damage caused by disaster.
6. Damage due to use of improper solvent or sample.

The warranty does not apply to fuses.

For inquiry or request for repair service, contact Bio-Rad Laboratories after confirming the model and serial number of your instrument.

For Technical Service call your local Bio-Rad office or in the U.S. call 1-800-4BIORAD (1-800-424-6723), or visit our website at [www.bio-rad.com](http://www.bio-rad.com).

This instrument, Serial No \_\_\_\_\_, is an authorized Thermal Cycler. Its purchase price includes the up-front fee component of a license under United States Patent Nos. 4,683,195, 4,683,202 and 4,965,188, owned by Roche Molecular Systems, Inc., and under corresponding claims in patents outside the United States, owned by F. Hoffmann-LaRoche Ltd, covering the Polymerase Chain Reaction ("PCR") process, to practice the PCR process for internal research and development using this instrument. The running royalty component of that license may be purchased from Applied Biosystems or obtained by purchasing Authorized Reagents. This instrument is also an Authorized Thermal Cycler for use with applications licenses available from Applied Biosystems. Its use with Authorized Reagents also provides a limited PCR license in accordance with the label rights accompanying such reagents. Purchase of this product does not itself convey to the purchaser a complete license or right to perform the PCR process. Further information on purchasing licenses to practice the PCR process may be obtained by contacting the Director of Licensing at Applied Biosystems, 850 Lincoln Centre Drive, Foster City, California, 94404, USA.

No rights are conveyed expressly, by implication or estoppel to any patents on real-time methods, including but not limited to 5' nuclease assays, or to any patent claiming a reagent or kit.

Applied Biosystems does not guarantee the performance of this instrument.

## Appendix C

### Product Information

Catalog Number	Product Description
170-8720	<b>iCycler with 96 x 0.2 ml Reaction Module</b> , includes iCycler base with the 96 x 0.2 ml iCycler Reaction Module, In-Sample temperature Probe (0.2 ml tube size), Comprehensive Instruction Manual, Quick Reference Card, PCR tubes, and power cord.
170-8703	<b>iCycler 96 x 0.2 ml Reaction Module</b> , includes 96 x 0.2 ml iCycler Reaction Module, In-Sample temperature Probe (0.2 ml tube size)
170-8722	<b>iCycler with 2 x 48 x 0.2 ml Reaction Module</b> , includes iCycler base with 2 x 48 x 0.2 ml iCycler Reaction Module, 2 In Sample Temperature Probes (0.2 ml tube size), Comprehensive Instruction Manual, Quick Reference Card, PCR Tubes, and power cord.
170-8705	<b>iCycler 2 x 48 x 0.2 ml Reaction Module</b> , includes 2 x 48 x 0.2 ml iCycler Reaction Module, 2 In-Sample Temperature Probes (0.2 ml tube size).
170-8724	<b>iCycler with 60 x 0.5 ml Reaction Module</b> , includes iCycler base with the 60 x 0.5 ml iCycler Reaction Module, In-Sample temperature Probe (0.5 ml tube size), Comprehensive Instruction Manual, Quick Reference Card, PCR tubes, and power cord.
170-8707	<b>iCycler 60 x 0.5 ml Reaction Module</b> , includes 60 x 0.5 ml iCycler Reaction Module and In-Sample temperature Probe (0.5 ml tube size)
170-8726	<b>iCycler with 384 Reaction Module</b> , includes iCycler base with the 384-well iCycler Reaction Module, Comprehensive Instruction Manual, Quick Reference Card, plates and sealing tape and power cord.
170-8709	<b>iCycler 384 Reaction Module</b> , includes 384-well iCycler Reaction Module
170-8714	<b>iCycler 0.2 ml Immersion Probe/Sample Cap</b>
170-8716	<b>iCycler 0.5 ml Immersion Probe/Sample Cap</b>
TWI-0201	<b>0.2 ml Tubes With Domes Caps</b> , natural, 1,000 (2 bags of 500)
TFI-0201	<b>0.2 ml Tubes With Flat Caps</b> , natural, 1,000
TBS-0201	<b>0.2 ml 8-Tube Strips Without Caps</b> , natural, 125
TCS-0801	<b>Domed 8-Cap Strips</b> , for 0.2 ml tubes and plates, natural, 120
TCS-0803	<b>Optical Flat 8-Cap Strips</b> , for 0.2 ml tubes and plates, ultraclear, 120
TBS-1201	<b>0.2 ml 12-Tube Strips Without Caps</b> , natural, 100
TCS-1201	<b>Domed 12-Cap Strips</b> , for 0.2 ml tubes and plates, natural, 200
TBI-0502	<b>0.5 ml Tubes With Flat Caps</b> , natural, 800 (8 bags of 100)
MLP-9601	<b>Multiplate 96-Well 0.2 ml Unskirted PCR Plates</b> , natural, 2
MSP-3842	<b>Microseal 384-Well PCR Plates</b> , version 2.0, natural, 50
MSB-1001	<b>Microseal 'B' Adhesive Seals</b> , 100
223-9442	<b>96-Well PCR Plate Sealing Mats</b> , 5



**Bio-Rad  
Laboratories, Inc.**

Life Science  
Group

---

**Web site** [www.bio-rad.com](http://www.bio-rad.com) **USA** (800) 4BIORAD **Australia** 02 9914 2800 **Austria** (01)-877 89 01 **Belgium** 09-385 55 11 **Brazil** 55 21 2527 3454  
**Canada** (905) 712-2771 **China** (86 21) 6426 0808 **Czech Republic** + 420 2 41 43 05 32 **Denmark** 44 52 10 00 **Finland** 09 804 22 00  
**France** 01 47 95 69 65 **Germany** 089 318 84-0 **Greece** 30 210 777 4396 **Hong Kong** (852) 2789 3300 **Hungary** 36 1 455 8800  
**India** (91-124)-2398112/3/4, 5018111, 6450092/93 **Israel** 03 951 4127 **Italy** 39 02 216091 **Japan** 03-5811-6270 **Korea** 82-2-3473-4460  
**Latin America** 305-894-5950 **Mexico** 55-52-00-05-20 **The Netherlands** 0318-540666 **New Zealand** 64 9 415 2280 **Norway** 23 38 41 30  
**Poland** + 48 22 331 99 99 **Portugal** 351-21-472-7700 **Russia** 7 095 721 1404 **Singapore** 65-64153188 **South Africa** 00 27 11 4428508  
**Spain** 34 91 590 52 00 **Sweden** 08 555 12700 **Switzerland** 061 717 95 55 **Taiwan** (886 2) 2578 7189/2578 7241 **United Kingdom** 020 8328 2000

---

Sig 1204

4006159 Rev J



## Artisan Technology Group is your source for quality new and certified-used/pre-owned equipment

- FAST SHIPPING AND DELIVERY
- TENS OF THOUSANDS OF IN-STOCK ITEMS
- EQUIPMENT DEMOS
- HUNDREDS OF MANUFACTURERS SUPPORTED
- LEASING/MONTHLY RENTALS
- ITAR CERTIFIED SECURE ASSET SOLUTIONS

### SERVICE CENTER REPAIRS

Experienced engineers and technicians on staff at our full-service, in-house repair center

### *InstraView*<sup>SM</sup> REMOTE INSPECTION

Remotely inspect equipment before purchasing with our interactive website at [www.instraview.com](http://www.instraview.com) ↗

### WE BUY USED EQUIPMENT

Sell your excess, underutilized, and idle used equipment. We also offer credit for buy-backs and trade-ins. [www.artisanng.com/WeBuyEquipment](http://www.artisanng.com/WeBuyEquipment) ↗

### LOOKING FOR MORE INFORMATION?

Visit us on the web at [www.artisanng.com](http://www.artisanng.com) ↗ for more information on price quotations, drivers, technical specifications, manuals, and documentation

**Contact us:** (888) 88-SOURCE | [sales@artisanng.com](mailto:sales@artisanng.com) | [www.artisanng.com](http://www.artisanng.com)