



Artisan Technology Group is your source for quality new and certified-used/pre-owned equipment

- FAST SHIPPING AND DELIVERY
- TENS OF THOUSANDS OF IN-STOCK ITEMS
- EQUIPMENT DEMOS
- HUNDREDS OF MANUFACTURERS SUPPORTED
- LEASING/MONTHLY RENTALS
- ITAR CERTIFIED SECURE ASSET SOLUTIONS

SERVICE CENTER REPAIRS

Experienced engineers and technicians on staff at our full-service, in-house repair center

*InstraView*SM REMOTE INSPECTION

Remotely inspect equipment before purchasing with our interactive website at www.instraview.com ↗

WE BUY USED EQUIPMENT

Sell your excess, underutilized, and idle used equipment. We also offer credit for buy-backs and trade-ins. www.artisanng.com/WeBuyEquipment ↗

LOOKING FOR MORE INFORMATION?

Visit us on the web at www.artisanng.com ↗ for more information on price quotations, drivers, technical specifications, manuals, and documentation

Contact us: (888) 88-SOURCE | sales@artisanng.com | www.artisanng.com

**PROTEAN[®] IEF
Cell**

**Instruction
Manual**

**Catalog Number
165-4000**



For Technical Service Call Your Local Bio-Rad Office or in the U.S. Call **1-800-4BIORAD** (1-800-424-6723)

Table of Contents

	Page
Section 1 Introduction	1
1.1 Overview	1
1.2 Features	1
1.3 Specifications	2
1.4 Unpacking	2
1.5 Safety	3
Section 2 Basic Set-Up and Operation.....	4
2.1 Instrument Components and Controls.....	4
2.2 Basic Operation	7
2.2.1 Programming Parameters	7
2.2.2 Programming Instructions.....	8
Section 3 Rehydration Program.....	10
3.1 Rehydration Programming Diagram	10
3.2 Rehydration Programming Instructions	11
Section 4 Running Preset Methods	12
4.1 Preset Method Programming Diagram	13
4.2 Preset Method Programming Instructions.....	14
Section 5 Stored Methods (RUN, EDIT, DELETE).....	16
5.1 Stored Method Programming Diagram	16
5.2 Stored Method Programming Instructions	17
Section 6 Programming a New Method.....	20
6.1 New Method Programming Diagram	21
6.2 New Method Programming Instructions.....	22
Section 7 Editing a Method While Running (Real Time Editing)	24
7.1 Real Time Editing Programming Diagram	24
7.2 Real Time Editing Programming Instructions	25
Section 8 Method Status Screens	26
8.1 Program Status Screen Diagram	26
8.2 Program Status Screen Instructions.....	27
Section 9 Error Screens.....	29
Section 10 Reagent and Strip Preparation	31
10.1 IPG Buffers and Reagents	31
10.1.1 IPG Strip Rehydration Buffers.....	31
10.1.2 2nd Dimension Equilibration Buffers	33
10.2 IPG Strip Preparation and Handling	33
10.2.1 IPG Strip Rehydration	33
10.2.2 Isoelectric Focusing	35
10.2.3 IPG Strip Storage	38
10.2.4 IPG Strip Equilibration (prior to 2nd dimension)	38
Section 11 Troubleshooting.....	38
Section 12 Accessories	39
12.1 Optional Thermal Printer Model DPU	39
12.2 ReadyStrips IPG Strips	41

Section 13	Cleaning and Maintenance	42
Section 14	Warranty	42
Section 15	Product Information and Accessories.....	42
Section 16	References	43

Section 1

Introduction

1.1 Overview

The PROTEAN IEF Cell performs the first dimension isoelectric focusing of two dimensional electrophoretic protein analysis. The PROTEAN IEF Cell can accommodate up to twenty-four 7 cm or twelve 17 cm Bio-Rad ReadyStrip™ IPG Strips for simultaneous isoelectric focusing.

The PROTEAN IEF system is comprised of a 10,000 V power supply with a Peltier temperature control platform, disposable 12 channel rehydration/equilibration trays, 12 channel focusing tray assemblies, and accessories.

The PROTEAN IEF Cell is fully programmable from the front panel and can store up to 10 user-defined methods. Passive or active (50V) rehydration can be programmed as a separate method, or as the first step of a method. Each method holds up to ten (10) steps where each step specifies the voltage, the manner of voltage ramping and the duration of the time segment. In addition to the user defined methods, the PROTEAN IEF Cell contains three pre-programmed methods specifically designed as a starting point for new samples and novice users to help determine optimal focusing conditions of ReadyStrip IPG Strips.

1.2 Features

The PROTEAN IEF Cell provides the following features

- Peltier temperature controlled focusing platform
- Maximum Voltage of 10,000 V
- Set voltage and voltage ramping profile in each step
- Time or Volt hour control in each step
- Integral or separate rehydration step
- Programmable current limit
- Simultaneous focusing of twenty-four 7 cm strips, or twelve 17 cm IPG strips
- Three pre-programmed (pre-set) methods
- Ten user-defined methods
- Run data collection via RS 232 port and optional Thermal Printer

1.3 Specifications

Input power	90–264 VAC, 47–63 Hz
Fuse	10A, 250 V, SLO-BLOW, 3AB Ceramic Body
Input power cord	3-wire; grounded
Power outputs	
Voltage	50–10,000 V, 1 V increments
Current	0–2.4 mA, 0.01 μ A increments
Power	0–24 Watts
Time	00:01–99:00 hours:minutes or 0–99,999 volt-hours
Focusing trays	
Material	Polycarbonate
Strip size	7, 17 cm
Capacity	12 strips per tray
	7 cm 17 cm
Electrode distance	64.5 mm 162 mm
Accommodates total strip length	82.3 mm 181 mm
Peltier platform	
Tray capacity	One 17 cm tray or two 7 cm trays
Temperature	10–25 °C \pm 0.5 °C @ max. ambient of 30 °C 15–25 °C \pm 0.5 °C @ max. ambient of 35 °C
Rehydration/equilibration trays	
Material	Polystyrene
Capacity	12 strips per tray
Accommodates total strip length	80 mm for 7 cm tray, 186 mm for 17 cm tray
Environmental requirements	For indoor use only. For use at altitudes up to 2000 meters. To be operated between 10 °C and 35 °C ambient. To be operated with a maximum relative humidity or 90% for temperatures up to 35 °C.
Regulatory	CE, EN61010-1
Dimensions	28(W)x30(D)x14(H) cm
Weight	12.5 lb. (5.7 kg)
User interface	
Control panel	12 key alpha-numeric keypad with 4 soft-keys and 3 function keys. Graphics display, 4 lines x 21 characters
Programmable parameters	Rehydration and focusing time, platform temperature, current limit per IPG strip, voltage and voltage ramping type for each step.
Voltage Ramping Profiles	Slow, Linear or Rapid
Protocol capacity	Three semi-programmable, pre-loaded methods. Ten programmable methods with up to ten (10) steps.
Data collection	RS232 serial port and optional thermal printer

1.4 Unpacking

When you receive the PROTEAN IEF Cell, carefully inspect the shipping container for any damage which may have occurred during shipping. Severe damage to a container may indicate damage to its contents. If you suspect damage to the contents may have occurred, immediately file a claim with the carrier in accordance with their instructions before contacting Bio-Rad Laboratories.

Open the shipping carton and lift the contents out of its packing. Inspect the instrument for external damage. If any part is missing or damaged, contact Bio-Rad Laboratories immediately.

1.5 Safety

Caution/Warning



The PROTEAN IEF Cell uses high output voltages that are electrically isolated from earth ground to minimize the risk of electrical shock to the user. The following guidelines should be observed and followed when using the power supply.



The PROTEAN IEF Cell has passed tests for operation at temperatures between 10 °C and 35 °C, with relative humidity between 0 and 90% non-condensing. Operating the cell outside these conditions is not recommended by Bio-Rad and will void the warranty.

This instrument is intended for laboratory use only.

1. To insure adequate cooling of the cell's power supply, be sure that there is at least 6 cm clearance around the unit. Do not block the fan vents at the rear or underneath the unit.

Warning!

Do not use cloth or absorbent pads under the unit. These or other loose items may be pulled into the fan intake, causing damage to the unit due to overheating, and voiding the warranty.

2. Always connect the cell to a 3-prong, grounded AC outlet, using the 3-prong AC power cord provided with the cell.
3. Do not operate the cell in extreme humidity (>90%) or where condensation can short the internal electrical circuits of the cell.
4. Disconnect power to the PROTEAN IEF Cell before servicing. No user-serviceable parts are inside the instrument. Contact Bio-Rad service personnel for service.
5. The PROTEAN IEF Cell is certified to meet the EN61010-1 safety standard for safety of laboratory equipment. Certified products are safe to use when operated in accordance with the instruction manual. This safety certification does not extend to other equipment or accessories not EN61010-1 certified, even when connected to the PROTEAN IEF Cell.
6. The PROTEAN IEF Cell conforms to the class A standards for Electromagnetic Emissions, intended for laboratory equipment applications. It is possible that emissions from this product may interfere with some sensitive appliances when placed nearby or on the same circuit as those appliances. The user should be aware of this potential and take appropriate measures to avoid interference.
7. This instrument should not be modified or altered in any way. Alteration of this instrument will void the manufacturer's warranty, void the EN61010-1 certification, and create a potential safety hazard for the user.
8. Bio-Rad is not responsible for any injury or damage caused by the use of this instrument for purposes other than those for which it is intended or by modifications of the instrument not performed by Bio-Rad or an authorized agent.

EN61010-1 is an internationally accepted electrical safety standard for laboratory instruments.

Section 2 Basic Set-up and Operation

2.1 Instrument Components and Controls

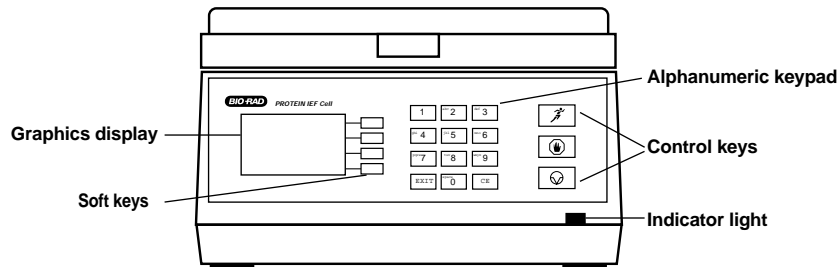





Fig. 1. Front panel display.

The soft keys, the alphanumeric key pad and the control keys are used to program the instrument. A detailed description of each of the keys is provided in the table below.

Key	Description												
<table border="1"> <tr> <td>1</td> <td>abc 2</td> <td>def 3</td> </tr> <tr> <td>ghi 4</td> <td>jkl 5</td> <td>mno 6</td> </tr> <tr> <td>pqrs 7</td> <td>tuv 8</td> <td>wxyz 9</td> </tr> <tr> <td>EXIT</td> <td>space 0</td> <td>CE</td> </tr> </table>	1	abc 2	def 3	ghi 4	jkl 5	mno 6	pqrs 7	tuv 8	wxyz 9	EXIT	space 0	CE	<p>The Alphanumeric Keys are used to enter numbers, letters and spaces during programming. To activate the keypad press the soft key adjacent to the parameter to be entered. The keypad is active when the cursor (-) and enter symbol (↵) are displayed on the LCD panel. Press the appropriate alphanumeric key repeatedly to scroll through selections until the desired letter or number appears on the LCD panel. Pressing the "0" key rapidly three times displays the "pH" symbol.</p> <p>The Exit Key is used to return to the previous screen during programming.</p> <p>The CE Key is used to clear an entry or to go back one character when entering values.</p>
1	abc 2	def 3											
ghi 4	jkl 5	mno 6											
pqrs 7	tuv 8	wxyz 9											
EXIT	space 0	CE											
<table border="1"> <tr><td> </td></tr> <tr><td> </td></tr> <tr><td> </td></tr> <tr><td> </td></tr> </table>					<p>Soft Keys</p> <p>Programming parameters are selected by pressing the green adjacent soft key. When an arrow (▶) is displayed, the adjacent soft key allows you to scroll through the parameters displayed on the adjacent line or to activate the keypad. The selected parameter is displayed in capitalized reverse-type. When values need to be entered for a selected parameter, the adjacent softkey is pressed and the (▶) is replaced by a cursor (-) and a return arrow (↵) are displayed. The alphanumeric keypad is then used to enter the required values.</p>								
	<p>Control Keys</p> <p>The Start key is pressed to begin or resume a programmed rehydration and/or a focusing method.</p>												
	<p>The Stop Key stops the run in progress. Total volt-hours are displayed. Pressing the stop key again when the run is stopped or complete returns you to the main screen.</p>												
	<p>The Pause Key interrupts the run in progress. The current method can be edited while paused.</p>												

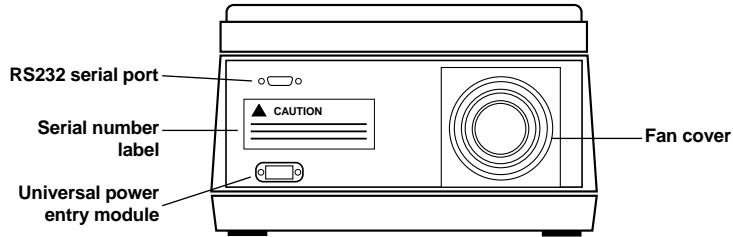

Fig. 2. Back panel display.

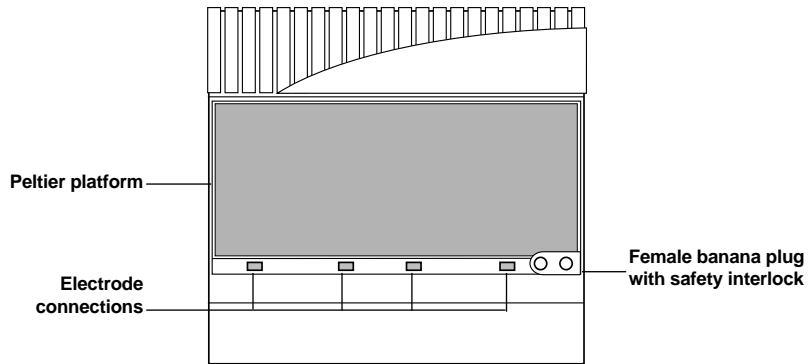

Fig. 3. Top platform.

Trays

To provide the maximum flexibility for variability in protocols the PROTEAN IEF Cell includes two different trays that can be used for rehydration; the disposable rehydration/equilibration tray and the focusing tray.

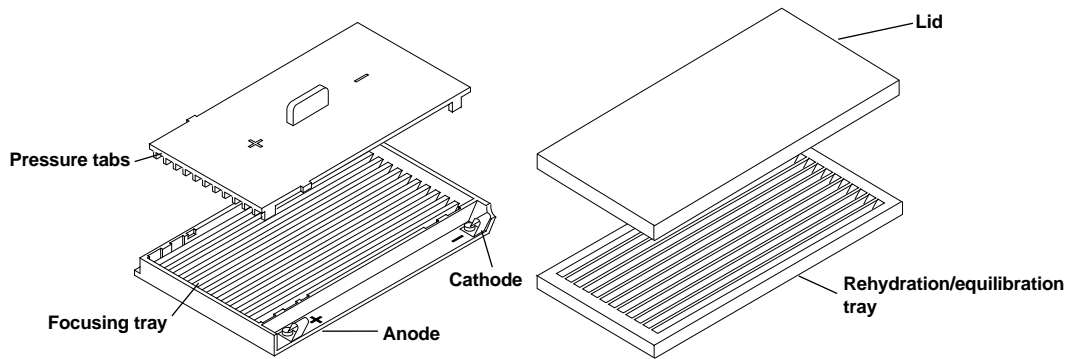

Fig. 4. Rehydration/equilibration trays and focusing trays.

Rehydration/Equilibration Tray

The disposable rehydration/equilibration tray is used to rehydrate IPG strips prior to isoelectric focusing and to equilibrate them prior to running the 2nd dimension. The use of a rehydration/equilibration tray simplifies IPG strip handling when employing electrode wicks. The rehydration/equilibration tray can also be used to equilibrate the IPG strips in buffer prior to running the 2nd dimension.

Focusing Tray

The focusing tray holds up to 12 IPG strips. It contains the electrodes for isoelectric focusing and wells for sample application. The focusing tray can be used for both the rehydration step and the isoelectric focusing run. The isoelectric focusing tray is used when a method includes an integral rehydration step as with active rehydration. Also, an isoelectric focusing tray must be used in all methods with an integral rehydration step that do not include a pause after rehydration.

Serial Port Functions for Printer or Computer Connection

The PROTEAN IEF cell has the ability to communicate with an external printer or computer via the RS232 serial port located at the back of the instrument. The PROTEAN IEF cell sends the data to these peripheral devices as ASCII text. The Thermal Printer can be directly connected to the PROTEAN IEF cell. A straight, serial cable is included with the printer and the DIP switches are pre-set.

Note: If a device other than the Bio-Rad Thermal Printer is used, a different type of cable may be required. Check the configuration of the printer or computer to determine if a straight serial cable or null modem cable is required and purchase the cable separately.

RS232 Printout of Running Conditions:

The PROTEAN IEF cell records the running conditions every 5 minutes during the isoelectric focusing portion of a method. The printout lists the details of the programmed method and values for all the parameters of each step.

```
Bio-Rad Laboratories
PROTEAN IEF Cell
Firmware Version: 1.40

Method "Name"
Rehydration: Inactive (Passive or Active @ 50 V)
Rehyde time: 00:00 Temp: 20 °C
Run Temp: 20 °C
Number of Gels: #           Max µA/Gel: 50
Step 01      250 V Ramp:R    Time: 00:15
Step 02      10000 V Ramp:S   Time: 01:00
etc.
End of Method list.
```

Start of run data.

00:00	1	xxxxV /	50	10 µA	0000 V hrs
Total time elapsed	Step #	Voltage and Ramp type	Total Current	Current per gel	Total Volthours

The printout will also indicate interruptions of the run, such as pause mode and interruption of power when the cell cover is opened. If there is poor contact between one of the IPG strips and the electrode, large fluctuations in resistance will hold the voltage constant at 500 volts until the user intervenes, preventing the IPG strips from burning. If the method is edited during the run the printout will display edited values with an asterisk.

2.2 Basic Operation

2.2.1. Programming Parameters

The PROTEAN IEF Cell programs control the following parameters of an isoelectric focusing run.

a. Rehydration

IPG strips must be rehydrated prior to isoelectric focusing. The PROTEAN IEF Cell provides the option of including a temperature controlled rehydration step in the focusing program or programming a separate rehydration program.

The user can perform the rehydration step in one of 3 ways.

- Integral Rehydration—the rehydration step is an integral step of a method.
- Separate Rehydration—the rehydration step is programmed separately using the rehydration mode.
- Other Rehydration—the rehydration step is performed outside the PROTEAN IEF cell.

IPG strips are rehydrated with buffer that may or may not contain the sample. IPG strips rehydrated with sample may be actively or passively rehydrated.

Active or Passive Rehydration

Active rehydration is only used when the sample is contained in the rehydration buffer. Active rehydration applies 50V to the IPG strips during rehydration to facilitate uptake of the sample into the IPG strip. Active rehydration requires the use of an isoelectric focusing tray.

Passive rehydration can be done with or without sample present in the rehydration buffer. The IPG strips are rehydrated without any voltage applied to them. Passive rehydration can be performed in either the rehydration/equilibration tray or the isoelectric focusing tray.

Rehydration Time

Rehydration time is programmable within the range of 00:01–99:00 hours. The recommended rehydration time (default value) is 12 hours.

Pause After Rehydration

A pause can be programmed after the rehydration step and prior to isoelectric focusing, whether you are using the pre-set or user-defined programs. A pause is needed for inserting electrode wicks, adding mineral oil, applying sample or transferring the strips from the disposable rehydration/equilibration tray to the focusing tray. If a pause is not inserted, then the program will proceed immediately to the first focusing step.

b. Peltier Platform Temperature

The Peltier platform temperature can be controlled during the rehydration and focusing steps. The programmable temperature range is from 10–25 °C.

c. Power Parameters

Voltage Ramping Method

Three voltage ramping options are available; Rapid, Linear and Slow. In the rapid ramp method the voltage ramp is current limited. In the linear ramp method the voltage increases in a linear fashion. In the slow ramp method, the voltage change is based on a delayed voltage ramping algorithm. In all three methods the current will not exceed the programmed current limit.

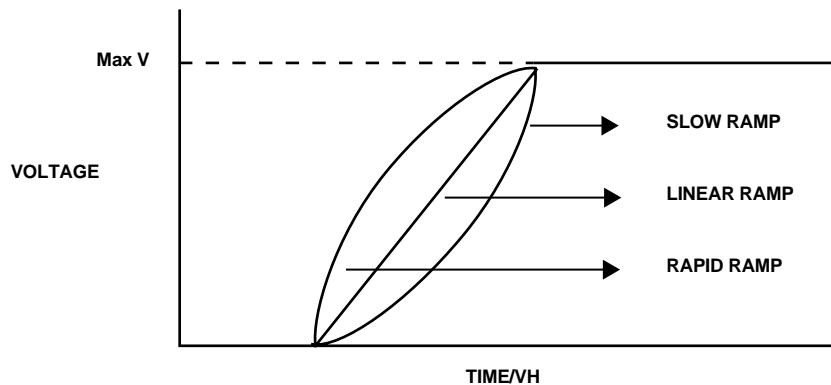

Voltage

In user defined programs, a maximum voltage value is entered for each step of the program. The maximum voltage is 10,000V.

Focusing Time

The length of time voltage is applied can be set in units of time up to 99:00 hours:minutes, or in volt-hours up to 99,999 volt-hours.

Current Limits

The maximum current output of the PROTEAN IEF Cell is 2.4 mA. The maximum current limit is 99 µA per strip. In the pre-set methods the default current limit is set to 50 µA to prevent overheating or burning of the IPG strips.

Hold Step

The pre-set program mode provides an optional hold step. The hold step maintains the voltage at 500 V until the run is stopped by the user. The hold step is used to eliminate effects of over-focusing or to prevent protein drift.

Note: A hold step can be programmed in a user-defined method by programming the last step of the method at 500 V for a specified length of time in the event that you are not present at the end of the focusing step.

2.2.2. Programming Instructions

The PROTEAN IEF Cell is designed to provide simple intuitive screen layouts for easy programming.

Turn on the power switch located on the right side of the cell. The initialization screen will be displayed for several seconds.

BIO-RAD LABORATORIES
PROTEAN IEF CELL
FIRMWARE VERSION 1.40
SYSTEM INITIALIZATION

The main screen displays four programming options. The user can program a separate rehydration method, select one of three preset methods, select or edit a previously stored method or program a new user-defined method.

REHYDRATION	>
PRESET METHOD	>
STORED METHOD	>
NEW METHOD	>

Section 3 Rehydration Program

The rehydration mode is used to program a separate rehydration step. The IPG Strips can be rehydrated in a temperature controlled environment. There are two different rehydration methods available, passive and active. When using the active rehydration method the IPG strips are positioned in the focusing tray (see Section 10 for details). For passive rehydration the IPG strips can be positioned in either the rehydration/equilibration tray or the focusing tray.

3.1 Rehydration Programming Diagram (not integral)

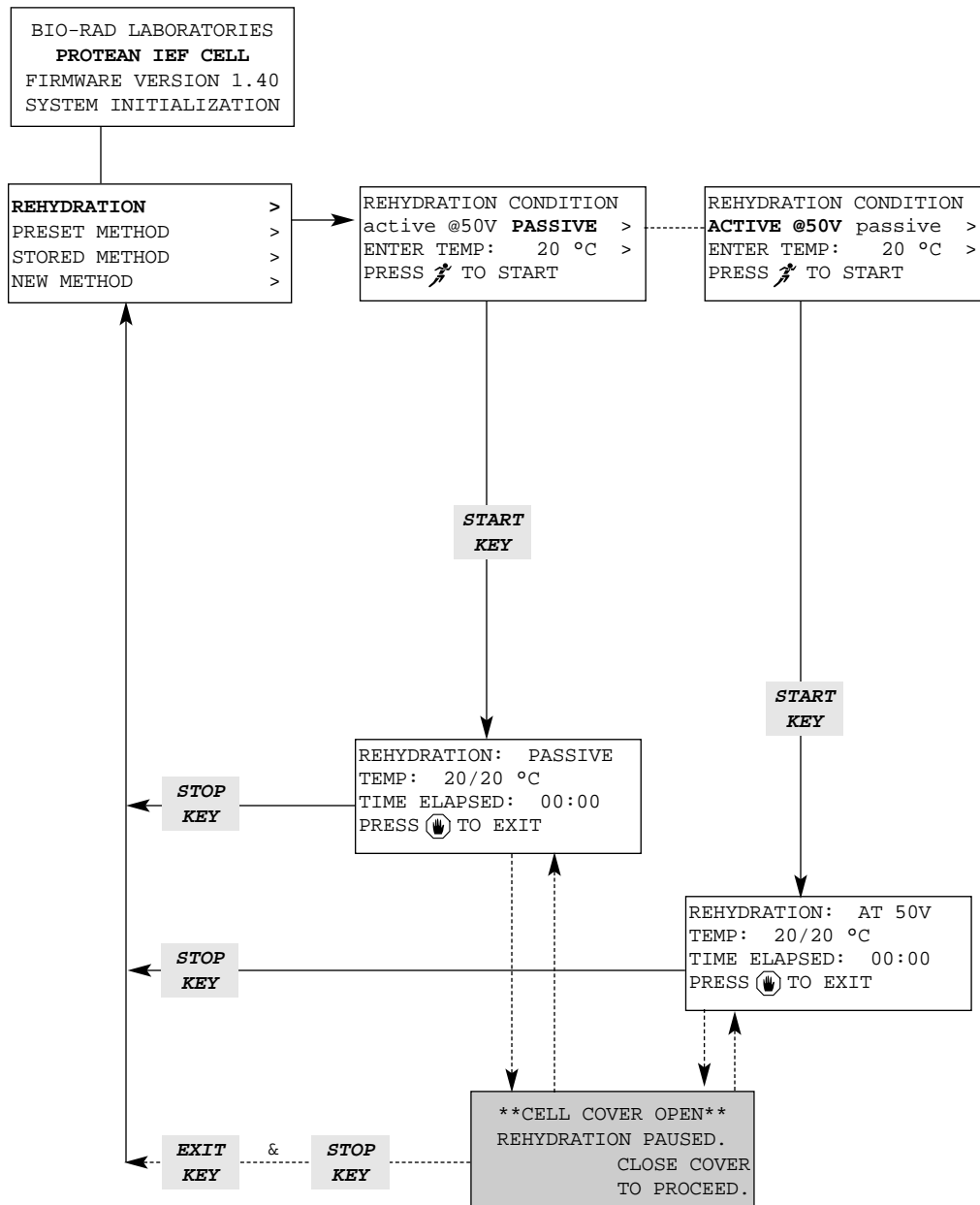

3.2 Rehydration Programming Instructions

```
REHYDRATION           >
PRESET METHOD          >
STORED METHOD          >
NEW METHOD              >
```

1. Select the Rehydration mode to program a rehydration method separate from a focusing program.

```
REHYDRATION CONDITION
active @ 50 V  PASSIVE >
ENTER TEMP:    20 °C >
PRESS  TO START
```

2. Select passive or active (50 V) rehydration.
Enter a rehydration temperature between 10–25 °C. The default value is 20 °C.
Press  to begin the rehydration program.

Passive Rehydration Running Screen

```
REHYDRATION:    PASSIVE
TEMP:    20/20 °C
TIME ELAPSED:    00:00
PRESS  TO EXIT
```

One of these two rehydration running screens will be displayed.

The maximum time the rehydration program will run is 99:00 hours.

Press the  key to return to the main screen.

Active Rehydration Running Screen

```
REHYDRATION:    AT 50 V
TEMP:    20/20 °C
TIME ELAPSED:    00:00
PRESS  TO EXIT
```

Section 4 Running Preset Methods

The PROTEAN IEF Cell contains three preset methods to be used as a starting point for new samples and novice users to help determine optimal focusing conditions. Each of the three methods is based on the manner in which the voltage is ramped in step 2x (the slope to reach the maximum voltage). In all preset methods the maximum applied voltage is based on the length of the IPG strip (4,000 V/7 cm; 8,000 V/11 cm; 10,000 V/17 cm). The program will prompt the user for the IPG strip size. Each of these methods provides an optimum maximum field strength of ~600 V/cm of IPG strip. The pre-set methods have a 50 μ A limit/IPG strip. If a different current limit is needed a customized method can be programmed using the NEW METHOD option.

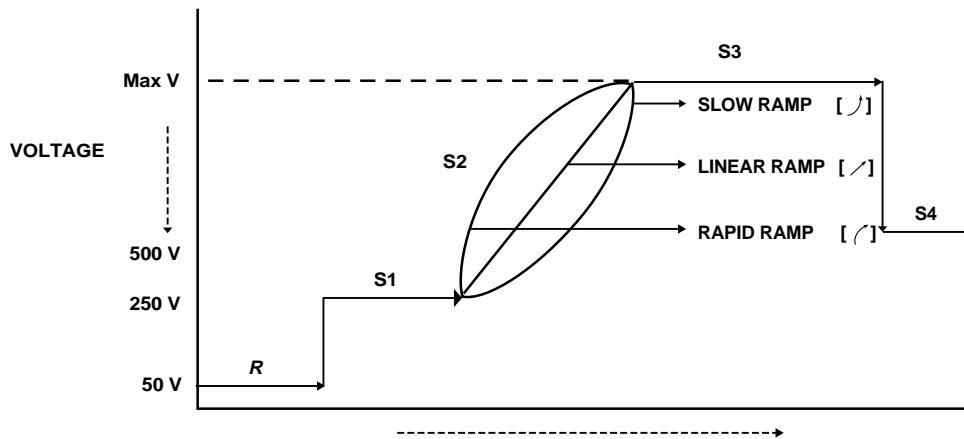
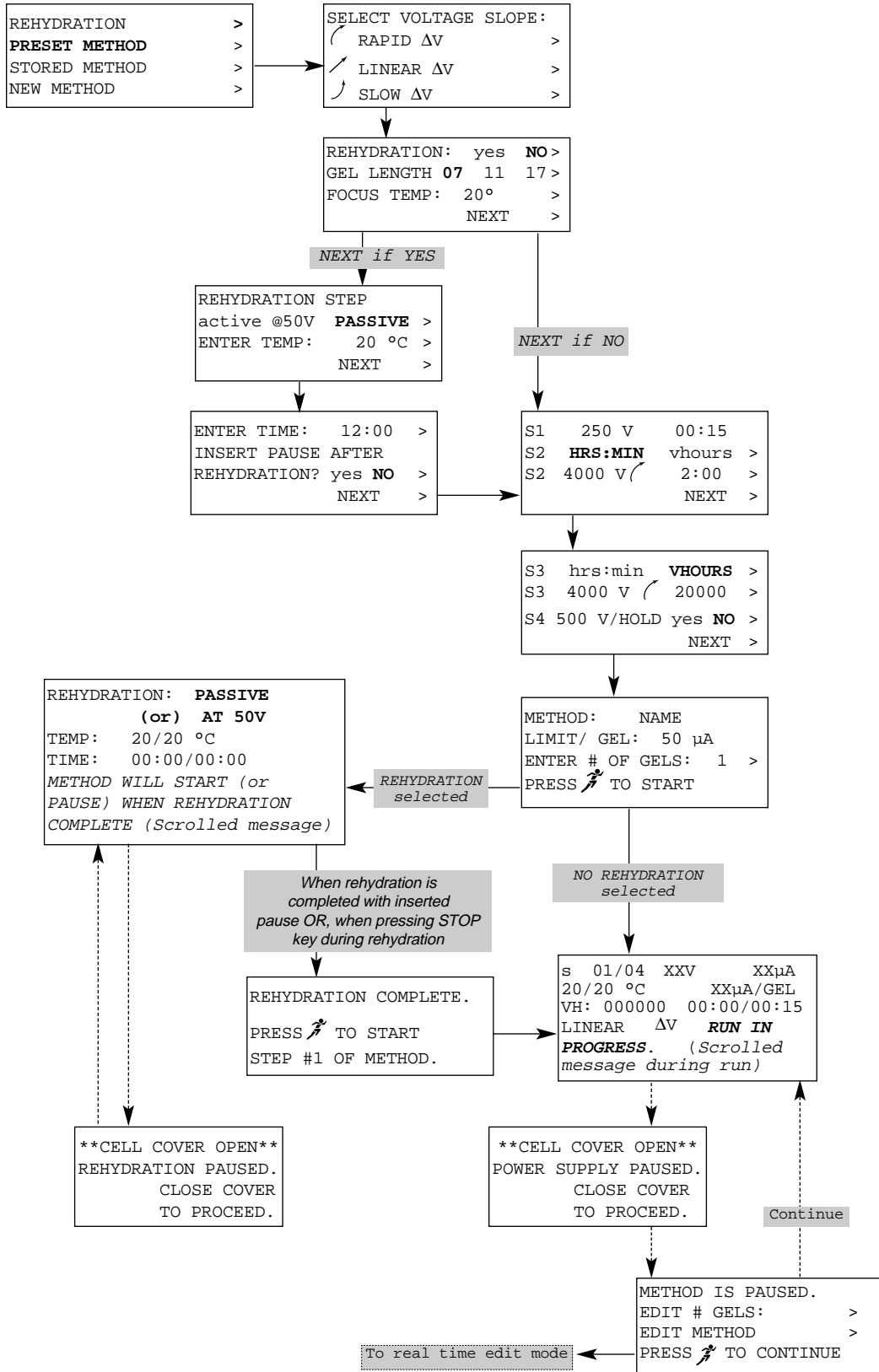

Fig. 5. Preset method voltage over time.

Step	Parameters								
R - Rehydration (*optional)	Passive, or Active at 50 V								
S1 - Conditioning Step	250 V for 15 minutes. A low voltage is applied in Step 1 to remove salt ions and charged contaminants.								
S2 - Voltage Ramping	Slow [/], Linear [/] or Rapid [/]. When the conditioning step is complete, the voltage ramping step increases the voltage to the maximum voltage in one of three ways. In all three cases the current will not exceed the 50 μ A/strip limit. See Section 2.2 for details.								
S3 - Final Focusing	A time is programmed to complete the focusing process once the maximum voltage is reached. If the maximum voltage is not reached at the completion of step 2, the voltage will increase to the maximum voltage using the rapid ramping method. The current limit will not exceed 50 μ A/strip.								
	<table border="1"> <thead> <tr> <th>Voltage</th> <th>IPG Strip</th> </tr> </thead> <tbody> <tr> <td>4,000 V</td> <td>7 cm</td> </tr> <tr> <td>8,000 V</td> <td>11 cm</td> </tr> <tr> <td>10,000 V</td> <td>17 cm</td> </tr> </tbody> </table>	Voltage	IPG Strip	4,000 V	7 cm	8,000 V	11 cm	10,000 V	17 cm
Voltage	IPG Strip								
4,000 V	7 cm								
8,000 V	11 cm								
10,000 V	17 cm								
S4 - Hold step (optional)	500 V is maintained until the run is stopped to prevent diffusion of focused proteins or over-focusing artifacts.								

*Rehydration step can be included in the preset method program or performed separately.

4.1 Preset Method Programming Diagram



4.2 Preset Method Programming Instructions

```

REHYDRATION >
PRESET METHOD >
STORED METHOD >
NEW METHOD >
    
```

1. Select the PRESET METHOD mode to program a preset method.

```

SELECT VOLTAGE SLOPE:
( / RAPID ΔV >
/ LINEAR ΔV >
) SLOW ΔV >
    
```

2. Select one of the three voltage ramping methods (slope). The difference between the methods is the manner in which the voltage is ramped to the maximum voltage (refer to Step S2 in Figure 5).

```

REHYDRATION:  yes  NO >
GEL LENGTH  07  11  17 >
FOCUS TEMP:   20° >
                NEXT >
    
```

3. Select the rehydration step (optional). **No** is the default.

Select the gel size (7, 11, or 17 cm). Default is 07 cm. The gel size entered determines the maximum voltage that is applied, 4000 V/7 cm, 8000 V/11 cm, and 10,000 V/17 cm.

Enter a focusing temperature between 10–25 °C. **20 °C** is the default temperature.

Press the NEXT soft key to continue.

Note: Proceed to Step 4 if a rehydration step is programmed. Proceed to Step 6 if a rehydration step is not programmed.

```

REHYDRATION
active@50V  PASSIVE >
ENTER TEMP:  20 °C >
                NEXT >
    
```

4. Select the Active (50 V) or Passive rehydration method. Passive rehydration is the default.

Enter a rehydration temperature between 10–25 °C. **20 °C** is the default temperature.

Note: Maintain the rehydration and running temperature above 18 °C if the rehydration buffer contains urea.

```

ENTER TIME:   12:00 >
INSERT PAUSE AFTER
REHYDRATION?  yes  NO >
                NEXT >
    
```

5. Enter a time for the rehydration step up to 99:00 hours. The default value is 12 hours.

Select yes or no to insert a pause after the rehydration step. **NO** pause is the default.

Press the NEXT key to continue.

Note: When a pause is programmed, the method will pause when the rehydration step is complete to allow for the transfer of strips to a focusing tray, insertion of electrode wicks, sample application, or the addition of mineral oil. If a pause is not programmed the method will automatically continue with the first focusing step after rehydration is completed. Therefore, be sure the strips are covered with mineral oil or similar overlay material during rehydration.

```

S1  250 V      00:15
S2  HRS:MIN   vhours  >
S2  4000 V    ↵  2:00  >
                                     NEXT  >

```

6. Conditioning step (S1) parameters cannot be changed.

Select the time or volt-hours option for the Voltage Ramping Step (S2).

Press the adjacent soft key to activate the alphanumeric keypad and enter a time up to 99:00 hours:minutes, or volt-hours up to 99,999.

Default values for Step 2:

7 cm 4,000 V - 2 hrs.

11 cm 8,000 V - 2:30 hrs.

17 cm 10,000 V - 3 hrs.

Press the NEXT key to continue.

```

S3  hrs:min   VHOURS
S3  4000 V    ↵  2:00  >
S4  500V/HOLD yes NO  >
                                     NEXT  >

```

7. Select the time or volt-hours option for the Final Focusing step (S3).

Enter a time up to 99:00 hours:minutes or up to 99,999 volt-hours. If the maximum voltage is not reached in Step 2, the rapid voltage slope is applied to reach the maximum voltage.

Default values for Step 3:

7 cm 4,000 V 20,000 vhours

11 cm 8,000 V 35,000 vhours

17 cm 10,000 V 60,000 vhours

Select yes or no to insert an optional Hold step (S4). **No** is the default parameter.

Note: If a Hold step is programmed the voltage will be maintained at 500 V until the run is stopped by the operator. If a Hold Step is not programmed the run will stop upon the completion of the final focusing step (S3).

Press the NEXT key to continue.

```

METHOD:      "METHOD NAME"
LIMIT/GEL:   50 µA
ENTER # OF GELS: 1  >
PRESS  TO START

```

8. The first line of this screen displays the pre-set method selected.

The second line displays the current limit/gel (50 µA).

Enter the # of gels (IPG strips) to be run: 1–24 for 7 cm gels, 1–12 for 17 cm gels. **1** is the default value.

Press  to start the run and refer to Section 8 for the program status screens.

Section 5 Stored Methods (RUN, EDIT, DELETE)

The PROTEAN IEF Cell stores up to ten (10) programmed methods. Each method contains up to ten (10) steps. In this mode a stored method can be run, edited or deleted.

5.1 Stored Method Programming Diagram

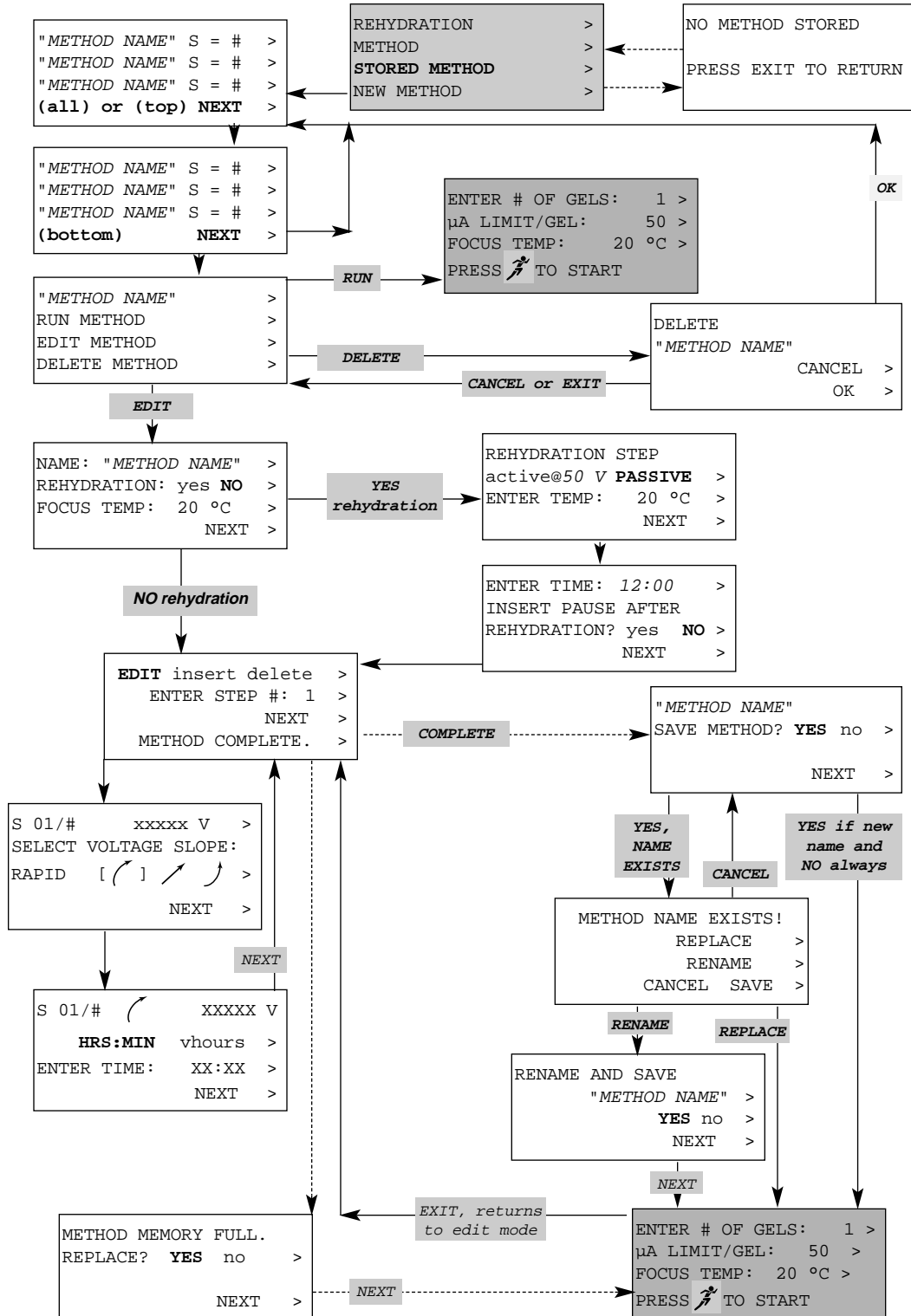

5.2 Stored Method Programming Instructions

```
REHYDRATION >  
PRESET METHOD >  
STORED METHOD >  
NEW METHOD >
```

1. Select the STORED METHOD mode to run, edit or delete a previously stored method.

```
"METHOD NAME" S = # >  
"METHOD NAME" S = # >  
"METHOD NAME" S = # >  
(all),(top)or(bottom) NEXT >
```

2. The screen will display the stored methods (three at a time) and the number of steps in the method.

Press the NEXT key to scroll through the stored methods.

Press the adjacent soft key to select the desired method.

```
"METHOD NAME"  
RUN METHOD >  
EDIT METHOD >  
DELETE METHOD >
```

3. The first line displays the selected method.

Press the adjacent soft key to Run, Edit or Delete the selected method.

RUN METHOD

```
ENTER # OF GELS: 1 >  
µA LIMIT/GEL: 50 >  
FOCUS TEMP: 20 °C >  
PRESS  TO START
```

1. Enter the # of gels (IPG strips); 1–24 for 7 cm gels, 1–12 for 17 cm gels.

Press the adjacent soft key to edit the programmed values for current limit and focusing temperature before starting the run.

Press  to start the run and refer to Section 8 for the program status screens.

EDIT THE METHOD

```

NAME: "METHOD NAME" >
REHYDRATION:  yes  NO >
FOCUS TEMP:    20 °C >
                NEXT >
    
```

1. Press the adjacent soft key to edit the name of the method.

Select yes or no for a rehydration step.

Enter the focusing temperature.

Press the NEXT soft key to continue.

```

EDIT (ADD) insert delete >
  ENTER STEP #: 1 >
                NEXT >
METHOD COMPLETE. >
    
```

2. Press the adjacent soft key to select edit, insert or delete a step.

Enter the step number. (1 is the default value.)

Press the NEXT soft key to enter selected step.

Note: inserted steps are inserted ahead of the step # entered.

```

S 01/#          10000 V >
SELECT VOLTAGE SLOPE:
RAPID  [ ( ) / \ ] >
                NEXT >
    
```

3. The selected step number, the total number of steps, the voltage and the voltage slope are displayed.

Use the soft keys to edit the voltage and the voltage slope.

Press the NEXT soft key to continue.

```

S 01/# ( 10000 V
  HRS:MIN vhours >
ENTER TIME:  XX:XX >
                NEXT >
    
```

4. Use the softkey to edit the time or volt-hours.

Press the NEXT soft key to continue.

```

EDIT (ADD) insert delete>
  ENTER STEP #: 1 >
                NEXT >
METHOD COMPLETE. >
    
```

5. Select the Edit, Insert or Delete option and the step # to edit the method further. Edit is converted to ADD if a step # is added to the method.

Select the Method Complete soft key when editing is complete.

```

"METHOD NAME"
SAVE METHOD? YES no >
                NEXT >
    
```

- 6a. The save method screen is displayed after the Method Complete key is selected.

Select yes to store a re-named or edited method to memory. Select no to run the edited method without saving it to memory.

Press the NEXT key to continue. (Go to step 8 if method name exists.)

```

METHOD MEMORY FULL.
REPLACE? YES no >
                NEXT >
    
```

- 6b. If memory is full, replace method, or run edited method without saving.

```

ENTER # OF GELS:      1 >
µA LIMIT/GEL:       50 >
FOCUS TEMP:         20 °C >
PRESS  TO START

```

- The adjacent screen is displayed after saving the method.

Enter the number of gels and edit current limit per gel if needed to 99 µA per gel maximum. Edit Focusing temperature if desired. Press  to start the run.

```

METHOD NAME EXISTS!
      REPLACE >
      RENAME >
CANCEL SAVE >

```

- If method name was not changed or if the method name already exists, the adjacent screen will be displayed.

Press the adjacent soft key to replace or rename the method.

Press cancel save to return to the previous screen.

```

RENAME AND SAVE >
      "METHOD NAME" >
      YES no >
      NEXT >

```

- Press the adjacent soft key to re-name the method. When the cursor and enter symbols are visible, use the alphanumeric keypad to enter the new name.

Select the YES option to save the re-named method. Select NO to run the method without saving it to memory.

Press the NEXT soft key to continue to the run screen.

```

ENTER # OF GELS:      1 >
µA LIMIT/GEL:       50 >
FOCUS TEMP:         20 °C >
PRESS  TO START

```

- The adjacent screen is displayed after saving the method.

Enter the number of gels and edit current limit per gel if needed to 99 µA per gel maximum. Edit Focusing temperature if desired. Press  to start the run.

DELETE A METHOD

```

DELETE
"METHOD NAME"

      CANCEL >
      OK >

```

- The method name is displayed.

Select cancel to cancel delete and return to the run/edit/delete screen.

Select OK to delete the method and return to the stored method screen.

Section 6

Programming a New Method

In the NEW METHOD mode a method containing one (1) to ten (10) steps can be programmed. Each method allows programming of the following parameters:

A rehydration step (optional)

- passive or active at 50 V
- rehydration temperature (10–25 °C)
- rehydration time up to 99:00 hours

A current limit up to 99 μ A per strip. 50 μ A per strip is recommended to prevent IPG strip overheating.

The isoelectric focusing temperature (10–25 °C)

Ten separate steps each programmable for:

- Voltage
- Voltage ramping slope (rapid, linear, or slow)
- Time in hours:minutes or volt-hours.

6.1 New Method Programming Diagram

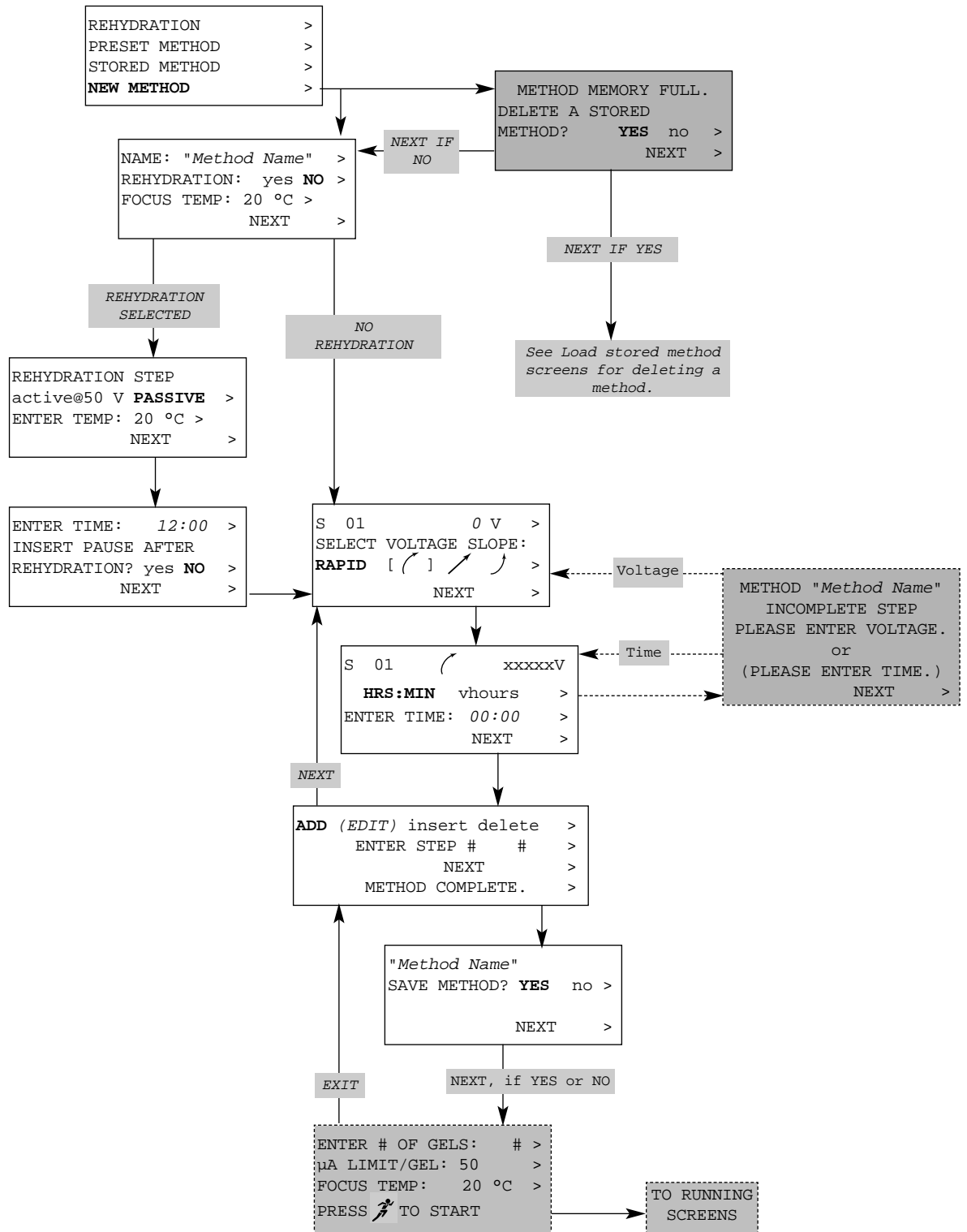

6.2 New Method Programming Instructions

```

REHYDRATION          >
PRESET METHOD         >
STORED METHOD         >
NEW METHOD          >
  
```

1. Select the NEW METHOD mode to program a new method.

```

NAME: "METHOD NAME" >
REHYDRATION: yes NO >
FOCUS TEMP:    20 °C >
                NEXT >
  
```

2. Use the adjacent soft-key to activate the alphanumeric keypad and enter a program name with up to 10 characters.

Select YES or No for a rehydration step (optional). **NO** is the default.

Enter a focusing temperature between 10–25 °C. **20 °C** is the default value.

Press the NEXT key to continue.

Note: If a rehydration step is programmed proceed to Step 3. If a rehydration step is not programmed proceed to Step 5.

```

REHYDRATION STEP
active@50 V    PASSIVE >
ENTER TEMP:   20 °C >
                NEXT >
  
```

3. Select the Active (50 V) or Passive rehydration option. Passive rehydration is the default.

Enter a rehydration temperature between 10–25 °C. Press the NEXT key to continue

```

ENTER TIME: 12:00 >
INSERT PAUSE AFTER
REHYDRATION? YES no >
                NEXT >
  
```

4. Enter a rehydration time between 1 minute and 99 hours.

Select yes to insert a pause after the rehydration step. Select no to proceed immediately with the first focusing step.

Press the NEXT key to continue.

Note: A pause is needed for inserting electrode wicks, adding mineral oil, adding sample, or transferring the strips from the disposable tray to the running tray.

```





S 01                0 V >
SELECT VOLTAGE SLOPE:
RAPID [ (↗) ↗ ↘ ] >
                NEXT >
  
```

5. Use the adjacent soft-key to activate the alphanumeric keypad and enter the desired voltage value (50–10,000 V).

Select the voltage ramping slope for the step. Brackets [] will surround the selected option.

Note: Rapid [(↗)] voltage ramping is limited by the current. The Linear [↗] voltage ramping option increases voltage linearly with respect to time. The Slow [↘] voltage ramping option increases voltage according to a delayed voltage ramping algorithm.

Press the NEXT key to continue.

<pre>S 01 ↶ xxxxxxV HRS:MIN vhours > ENTER TIME: 00:00 > NEXT ></pre>	<p>6. The first line displays the step number, the selected slope, and the entered voltage. Select the time or volt-hours option for this step. Enter a time up to 99:00 hours:minutes, or volt-hours up to 99,999. Press the NEXT key to continue.</p>
<pre>ADD (EDIT) insert delete > ENTER STEP #: # > NEXT > METHOD COMPLETE ></pre>	<p>7. The ADD(EDIT)/Insert/Delete screen with the next step number in the method is displayed. Use the adjacent soft key to edit, insert, or delete a step in the method. Press the NEXT key and repeat steps 5 and 6 to add steps to the method. Select the method complete softkey when programming is complete. Note: An inserted step is inserted ahead of the step # entered.</p>
<pre>"METHOD NAME" SAVE METHOD? YES no > NEXT ></pre>	<p>8. The save method screen is displayed after the Method Complete key is selected. Select yes to save the method to memory. Select no to run the method without saving it to memory. Press the NEXT key to continue.</p>
<pre>ENTER # OF GELS: 1 > µA LIMIT/GEL: 50 > FOCUS TEMP: 20 °C > PRESS  TO START</pre>	<p>9. The adjacent screen is displayed after saving the method. Enter the number of gels and edit current limit per gel if needed to 99 µA per gel maximum. Edit Focusing temperature if desired. Press  to start the run.</p>
<pre>METHOD NAME EXISTS! REPLACE > RENAME > CANCEL SAVE ></pre>	<p>10. The Method Name Already Exists. If the method name already exists the adjacent screen will be displayed. Press the adjacent soft key to replace or rename the method. Press cancel save to return to the previous screen.</p>
<pre>RENAME AND SAVE > "METHOD NAME" > YES no > NEXT ></pre>	<p>11. Press the adjacent soft key to re-name the method. When the cursor and enter symbols are visible, use the alphanumeric keypad to enter the new name. Select the YES option to save the re-named method. Select NO to continue to the run screen without saving the method. Press the NEXT key to continue to the run screen.</p>
<pre>ENTER # OF GELS: 1 > µA LIMIT/GEL: 50 > FOCUS TEMP: 20 °C > PRESS  TO START</pre>	<p>12. The adjacent screen is displayed after replacing the method. Enter the # of gels (IPG strips); 1–24 for 7 cm gels, 1–12 for 17 cm gels. Press  to start the run and refer to Section 8 for program status screens.</p>

Section 7

Editing a Method While Running (Real Time Editing)

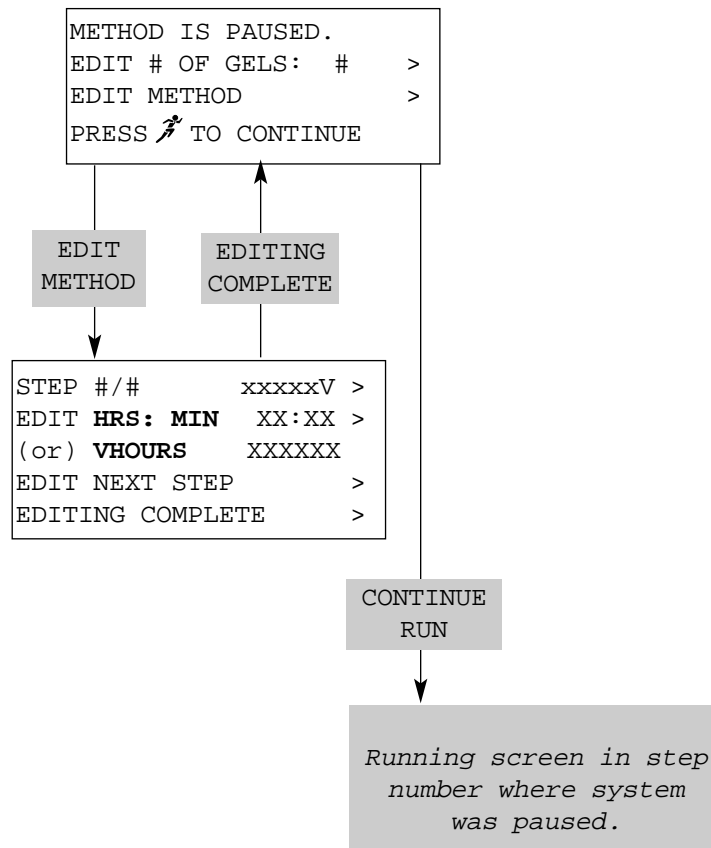

Real time editing allows the user to modify a method during a run. Press the pause key to enter the real time editing mode. Real time edits only affect the current run and changes can not be stored or saved. The originally stored method remains unchanged.

7.1 Real Time Editing Programming Diagram



7.2 Real Time Editing Programming Instructions

```
METHOD IS PAUSED
EDIT # OF GELS:      # >
EDIT METHOD          >
PRESS  TO CONTINUE
```

1. Press the  key to pause the method.
Press the adjacent soft key to edit the number of IPG strips for this run only.
Select EDIT METHOD to edit steps in the method.
Press the  key to resume the method.

```
STEP #/#:          xxxxxxV >
      HRS:MIN      XX:XX  >
(or) V HOURS      XXXXX
EDIT NEXT STEP    >
EDITING COMPLETE >
```

2. The current step number and total number of steps are displayed. Only the current and subsequent steps can be edited.
Press the adjacent soft key to edit the voltage.
Press the adjacent soft key to edit the time or volt-hours.
Edited values cannot be less than the elapsed time or volt-hours for the paused step.
Press the EDIT NEXT STEP key to edit additional steps. If the method consists of only one step this option is not available. Adding steps during real time editing is not allowed.
Press EDITING COMPLETE to exit the edit mode and return to the pause screen.

```
METHOD IS PAUSED
EDIT # OF GELS:      # >
EDIT METHOD          >
PRESS  TO CONTINUE
```

3. Press the  to resume the run.
Edited values during real time editing are not saved.

Section 8 Method Status Screens

8.1 Program Status Screen Diagram

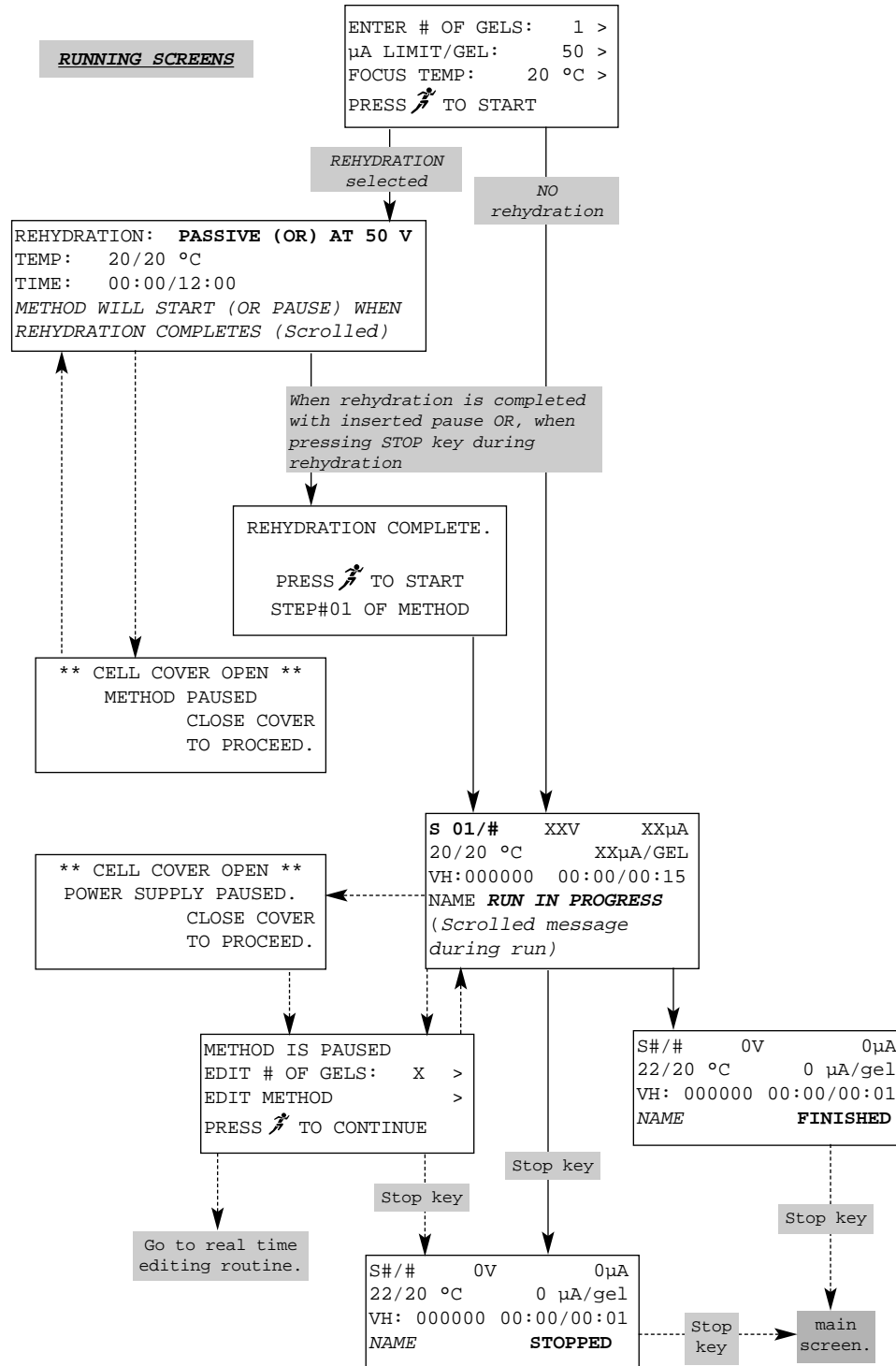

8.2 Program Status Screen Instructions

```

ENTER # OF GELS:      1 >
µA LIMIT/GEL:        50 >
FOCUS TEMP:          20 °C >
PRESS  TO START
    
```

1. Start Run Screen

Enter the number of IPG strips to run.

Enter a current limit up to 99 µA.

Enter the focusing temperature (10–25 °C).

Press  to start the run.

```

REHYDRATION:  AT 50 V
TEMP:         20/20 °C
TIME:         00:00/00:00
METHOD WILL START (OR PAUSE)
WHEN REHYDRATION COMPLETES
(Scrolled)
    
```

2. Active/Passive Rehydration Display.

- The actual and set temperatures are displayed (actual/set).
- Time is listed as elapsed time/programmed time.

Press  to stop the rehydration step.

```

** CELL COVER OPEN **
REHYDRATION PAUSED

CLOSE COVER TO PROCEED
    
```

3. When cell cover is opened the method is paused. Close the lid to resume the rehydration step.

```

REHYDRATION COMPLETE.

PRESS  TO START
STEP #01 OF METHOD
    
```

4. Rehydration Complete Display - This screen is displayed when the rehydration step is complete and a pause after rehydration step has been programmed. In the pause mode the system maintains the programmed temperature. At this point IPG strips can be transferred to the focusing trays if needed, electrode wicks can be inserted and sample and/or mineral oil or similar overlay material can be added to the individual channels.

Press  to start step 1 of the method.

```

S 01/#      XXV      XXµA
20/20 °C           XXµA/GEL
VH: 000000    00:00/XX:XX
NAME  RUN IN PROGRESS
(Scrolled message during
run)
    
```

5. S## (Current Step) Display

- The actual voltage and the total current are displayed.
- The actual / set temperatures and the current limit per gel are displayed.
- The Total VH listed are cumulative but do not include the rehydration step (active) or the optional final hold step.
- Time or vhours is listed as elapsed time (vhours)/programmed time (vhours).
- The Method Name is displayed. "Run in progress" is scrolled during the run.

```

** CELL COVER OPEN **
POWER SUPPLY PAUSED

CLOSE COVER TO PROCEED



```

6. When the cell cover is opened during a run the power supply is paused.
Close the lid to proceed to the method paused screen.

```

METHOD IS PAUSED.
EDIT # OF GELS:      #    >
EDIT METHOD          >
PRESS  TO CONTINUE

```

7. Method is Paused screen is displayed when the  button is pressed.
Press the adjacent softkey to edit the number of gels if any have been removed.
Select EDIT METHOD to edit the current method. (See Section 7 for real time editing.)
Press  key to continue method.

```

S #/#      0 V      0 μA
20/20 °C      0 μA/gel
VH: 000000 00:00/00:01
"METHOD NAME" FINISHED

```

8. Final Run Screen (Stopped or Finished)
The final run screen is displayed when a method is completed or is stopped during the run.
- The actual / set temperature is displayed.
 - The total volt-hours listed are cumulative but do not include the rehydration step (active).
 - The Method Name and STOPPED or FINISHED is displayed.
- Press the  to return to the main screen.

```

S 04/04      500V  XXμA
20/20 °C      XXμA/gel
VH: 000000 00:00
HOLD VH:XXXX HOLDING
500V - PRESS (Stop key
symbol) TO STOP
(scrolled message)

```

9. Hold Screen Display of Preset Methods
This screen lists the holding voltage, total current, and current per gel.
The VH listed are the total volthours of the completed method excluding the hold step.
The displayed time is the elapsed time of the hold step.
The HOLD VH displayed is the elapsed volthours for the hold step only.

Section 9 Error Screens

Error Display Screens	Description of Error Screens
<p>1. <pre>* * CELL COVER OPEN * * REHYDRATION PAUSED (or) POWER SUPPLY PAUSED. CLOSE COVER TO PROCEED.</pre></p>	<p>When the Cell Cover is opened during either rehydration or while running a method, the PROTEAN IEF Cell is paused.</p>
<p>2. <pre>"METHOD NAME" INCOMPLETE STEP PLEASE ENTER VOLTAGE or PLEASE ENTER TIME NEXT ></pre></p>	<p>This error screen is displayed if a zero value is entered for voltage or time when programming or editing a method.</p>
<p>3. <pre>RUN AT: 500V XXµA TIME: 00:00 00000 VH ERRATIC RESISTANCE PRESS PAUSE KEY. CHECK GEL/ELECTRODE CONTACTS IN TRAY. (scrolled message)</pre></p>	<p>This error screen is displayed because of recurring significant changes in resistance. To prevent diffusion of focused proteins the PROTEAN IEF Cell maintains the run at 500V. The displayed time and Volthours are the elapsed time and volthours while in this maintenance mode. Press the pause key to exit this maintenance mode and enter the pause mode. Before resuming the method check to make sure all gels are in direct contact with the electrode. Remove strips that show any evidence of burning. Burned strips can be caused by high current (we recommend a current of < 50 µA per strip), or poorly rehydrated IPG strips. Incomplete (<10 hours) rehydration can result in electrical discontinuities causing large fluctuations in resistance. Note: When the PROTEAN Cell switches to the maintenance mode, the timer of the method itself is stopped and will continue where it left off when the method is resumed.</p>
<p>4. <pre>OVER VOLTAGE ERROR or OVER CURRENT ERROR C=XXX V=XXX CYCLE POWER TO RESET</pre></p>	<p>The system is running outside the operating limits. Check the gel and tray to insure proper contact. Recycle the power to reset instrument. Turn off the mains power, then wait 10 seconds before turning the mains power back on. If the problem persists, record the values listed and call Bio-Rad at 1-800-4BIORAD or contact your local Bio-Rad representative.</p>

Error Display Screens

Description of Error Screens

- | | |
|--|---|
| 5. <pre>PROT. IEF E TRAP POSSIBLE ARCING CHECK TRAY CYCLE POWER TO RESET</pre> | <p>System error or possible arcing in focusing tray. Check the gel and tray to insure proper contact. Also, make sure the IPG strips have been sufficiently rehydrated. Incomplete (<10 hours) rehydration can result in electrical discontinuities causing large fluctuations in resistance and possibly arcing. Recycle power to reset instrument. Turn off the mains power, then wait 10 seconds before turning the mains power back on.</p> <p>If the problem persists, call Bio-Rad at 1-800-4BIORAD or contact your local Bio-Rad representative.</p> |
| 6. <pre>VOLTAGE OFFSET ERROR! OR CURRENT OFFSET ERROR! CHECK TRAY CYCLE POWER TO RESET</pre> | <p>Voltage or current is outside operating parameters of the PROTEAN IEF Cell. Check the IPG strips. Recycle the power to reset the instrument. Turn off the mains power, then wait 10 seconds before turning the mains power back on. If the problem persists, call Bio-Rad at 1-800-4BIORAD or contact your local Bio-Rad representative.</p> |
| 7. <pre>CHECKSUM ERROR IN "METHOD NAME" REVIEW METHOD STEPS! NEXT ></pre> | <p>This message is displayed when verification of the selected method failed. Review the steps of the method to confirm all values are correct before proceeding. Wait 10 seconds before pressing the NEXT soft key or reset the instrument by recycling the power. Turn off the mains power, then wait 10 seconds before turning the mains power back on. Review the steps in the method to confirm that all values are valid. Replace the method before proceeding. If problem persists call Bio-Rad at 1-800-4BIORAD or contact your local Bio-Rad representative.</p> |
| 8. <pre>ERROR WRITING EEPROM METHOD NOT SAVED P=XXX M=XXX O=XXX NEXT ></pre> | <p>System error.</p> <p>Recycle the power to reset the instrument. Turn off the mains power, then wait 10 seconds before turning the mains power back on.</p> <p>If the problem persists, record the values listed and call Bio-Rad at 1-800-4BIORAD or contact your local Bio-Rad representative.</p> |
| 9. <pre>BAD VOLTAGE VC=XXX, VO=XXX IC=XXX, IO=XXX</pre> | <p>System error.</p> <p>Recycle the power to reset the instrument. Turn off the mains power, then wait 10 seconds before turning the mains power back on.</p> <p>If the problem persists, record the values listed and call Bio-Rad at 1-800-4BIORAD or contact your local Bio-Rad representative.</p> |

Error Display Screens	Description of Error Screens
10. <pre>PROT. IEF E TRAP /0 ADDR=xxxxx:xxxxx T=XX, CTXT=XXX CYCLE POWER TO RESET</pre>	System error. Recycle the power to reset the instrument. Turn off the mains power, then wait 10 seconds before turning the mains power back on. If the problem persists, record the values listed and call Bio-Rad at 1-800-4BIORAD or contact your local Bio-Rad representative.
11. <pre>PROT. IEF E TRAP ME: XXX, TYPE=XXX T=XX, CTXT=XXX CYCLE POWER TO RESET</pre>	System error. Recycle the power to reset the instrument. Turn off the mains power, then wait 10 seconds before turning the mains power back on. If the problem persists, record the values listed and call Bio-Rad at 1-800-4BIORAD or contact your local Bio-Rad representative.
12. <pre>PROT. IEF E TRAP ERR: XXX ERRV=XXX T=XX, CTXT=XXX CYCLE POWER TO RESET</pre>	System error. Recycle power to reset instrument. Turn off the mains power, then wait 10 seconds before turning the mains power back on. If the problem persists, record the values listed and call Bio-Rad at 1-800-4BIORAD or contact your local Bio-Rad representative.

Section 10 Reagent and Strip Preparation

10.1 IPG Buffers and Reagents

10.1.1. IPG Strip Rehydration Buffers

Prior to isoelectric focusing, the IPG strips are rehydrated with rehydration buffer. Two different rehydration buffers are listed; one for rehydration without sample and one for sample application during rehydration. Rehydration with protein sample minimizes solubility problems and allows for larger sample loads. The optimal rehydration buffer composition for each type of sample is best determined empirically.^{1,2,3}

1. First Dimension

REHYDRATION BUFFER Without protein sample		REHYDRATION BUFFER With protein sample	
8-9.8 M Urea*	4.8-5.8g/10ml	8-9.8 M Urea*	4.8-5.8 g/10 ml
0.5% CHAPS	50 mg/10ml	1-4% CHAPS*	100-400 mg/10 ml
10 mM DTT (Dithiothreitol) or, 2mM Tributylphosphine**	15 mg/10ml	15-100 mM DTT* (Dithiothreitol) or, 2mM Tributylphosphine**	23-150 mg/10 ml
0-0.2% (w/v) Bio-Lytes†		0-0.2% (w/v) Bio-Lytes†	
0.001% Orange G or Bromophenol Blue		0.001% Orange G or Bromophenol Blue	

* The amounts of Urea, CHAPS, DTT, and Bio-Lytes required depend on the sample solubility. The amounts listed here serve as a general guideline. The optimal rehydration buffer composition for each sample type is best determined empirically.

** Tributylphosphine is an alternative reducing agent for DTT.^{4,5,6,7}

† pH gradient corresponding to IPG Strip gradient.

IPG Strip Rehydration

	7 cm ReadyStrip	17 cm ReadyStrip
Minimum rehydration volume Rehydrates strip to a gel thickness of 0.5 mm, and gel composition of 4%T/3%C	125 µl	300 µl
Maximum rehydration volume Increased rehydration volume allows for larger protein sample load, facilitates entry of larger proteins, and minimizes protein solubility problems	250 µl	600 µl

Sample Loading Following ReadyStrip Rehydration

Samples can be applied following rehydration immediately prior to focusing. The rehydrated ReadyStrips are positioned in the focusing tray and covered with mineral oil or similar overlay material. The sample is then added to the sample loading wells on the channel in the focusing tray. The recommended sample volume for tray loading is up to 30 µl/ReadyStrip.

10.1.2 2nd Dimension Equilibration Buffers

Prior to running the 2nd dimension (SDS-PAGE) it is necessary to equilibrate the ReadyStrips.

The first equilibration step is required to saturate the ReadyStrip IPG Strips with SDS and reducing agent.

When DTT is used a second equilibration step is required. The Iodoacetamide prevents protein re-oxidation during electrophoresis and alkylates residual DTT to minimize vertical streaking.

Equilibration buffer (Prepare immediately prior to use) Step 1: 10–15 min in equilibration buffer I		Equilibration Buffer II (Prepare immediately prior to use) Step 2 : 10–15 min in equilibration buffer II	
6 M Urea	3.6 g/10 ml	6 M Urea	3.6 g/10 ml
2% SDS	0.2 g/10 ml	2% SDS	0.2 g/10 ml
0.375M Tris-HCl pH 8.8	2.5 ml 1.5 M Tris-HCl, pH 8.8 /10 ml	0.375M Tris-HCl pH 8.8	2.5 ml 1.5 M Tris-HCl, pH 8.8 /10ml
20% Glycerol	2 ml/10 ml	20% Glycerol	2 ml/10 ml
130 mM DTT	200 mg/10 ml	135 mM Iodoacetamide	250 mg/10 ml

10.2 IPG Strip Preparation and Handling

10.2.1. IPG Strip Rehydration

Select IPG strip with the pH range required for optimum separation of the proteins. Refer to Section 6.2 for IPG strip specifications.

Note: Always wear gloves when handling IPG strips to prevent contamination.

IPG strips must be rehydrated prior to the isoelectric focusing run. Rehydrate the IPG strips using one of the two basic methods (with or without sample) given below.

Rehydration (with sample)

The recommended method for applying protein samples to ReadyStrip IPG strips is to rehydrate the strips in buffer containing sample. This is the simplest method to use and allows for loading of larger quantities of proteins (up to 1 mg) while preventing sample precipitation. The sample should be prepared in a buffer containing urea, non-ionic and/or zwitterionic detergents, carrier ampholytes, and a reducing agent. The optimal buffer composition and protein load will be sample dependent.

Prepare the sample in Rehydration Buffer. In general, use 5–100 µg for silver staining and up to 1 mg for Coomassie staining. Refer to Section 10.1 for commonly used rehydration solutions.

Rehydration (without sample)

Some proteins do not diffuse readily into the matrix of the IPG strip. In those cases the sample can be applied to the IPG strips following rehydration just prior to focusing. The IPG strips are rehydrated in Rehydration Buffer without sample and the sample is applied via the channels of the focusing tray.

Select the appropriate disposable rehydration tray or the focusing tray for rehydration of the IPG strips.

Note: The focusing tray must be used for active rehydration. Passive rehydration of the IPG strips can take place in the disposable rehydration tray or in the IPG focusing tray.

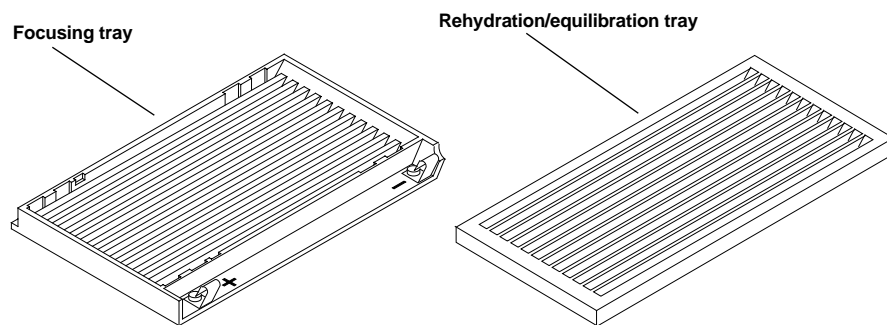

Fig. 6. Rehydration/equilibration tray & focusing trays.

Open the IPG strip package and carefully remove the protective cover from the IPG strip(s) with forceps. Discard the cover.

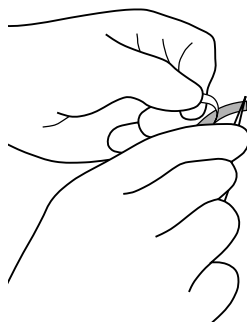
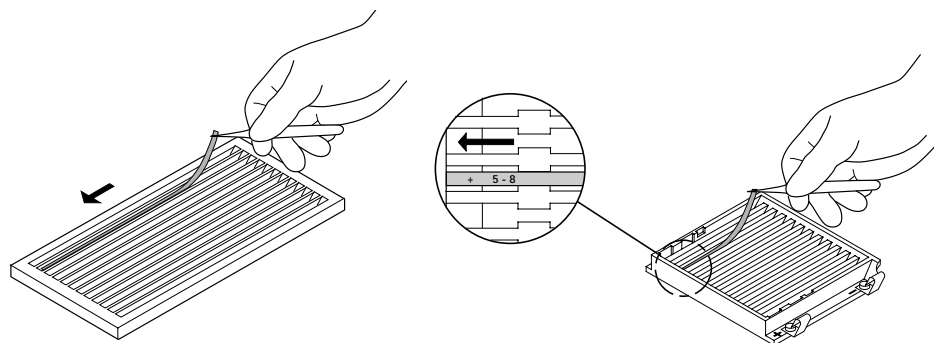

Fig. 7. Cover removal.

Add the appropriate rehydration solution (with or without protein sample) to each channel.

Bio-Rad ReadyStrip IPG Strip	Volume per Channel
7 cm strip	125 μ l
17 cm strip	300 μ l

Place the IPG strip gel side down into a tray channel. Wet the strip by sliding it through the rehydration solution as you place it into the channel of the tray. Minimize the amount of solution on top of the strip and insure that each strip is completely wetted to prevent uneven rehydration.



a. Rehydration/equilibration tray

b. Focusing tray.

Fig. 8. IPG strip placement in tray.

Apply mineral oil or similar overlay material to each channel containing an IPG Strip. Make sure the entire strip is covered.

Place the cover lid on the tray.

Place the tray on the Peltier platform. For active rehydration be sure to align the electrodes of the focusing tray with the Peltier electrode connections on the platform as shown in Figure 13.

Program or select the desired method (refer to Section 2.2) and start the run. The program may include a pause step after rehydration in order to transfer strips from the rehydration tray to the focusing tray and/or to add electrode wicks before the isoelectric focusing begins (or to add mineral oil).

Note: Electrode wicks should never be used during the rehydration step as the wicks can absorb the applied sample.

10.2.2. Isoelectric Focusing

Once the IPG strips are rehydrated they can be focused with or without the use of pre-wetted electrode wicks. Electrode wicks are recommended.

Prewet electrode wicks in deionized water blotting off excess water. Insert electrode wicks directly on top of both the cathode and anode electrode wires in the focusing tray just prior to focusing.

If a focusing tray is used for the rehydration step, carefully insert damp electrode wicks by gently lifting the IPG strip and placing it between the electrode and the strip. (Refer to Figure 9.)

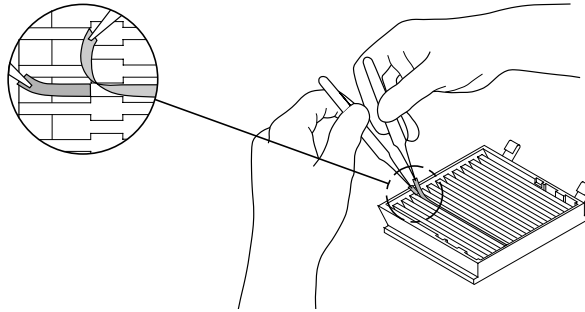
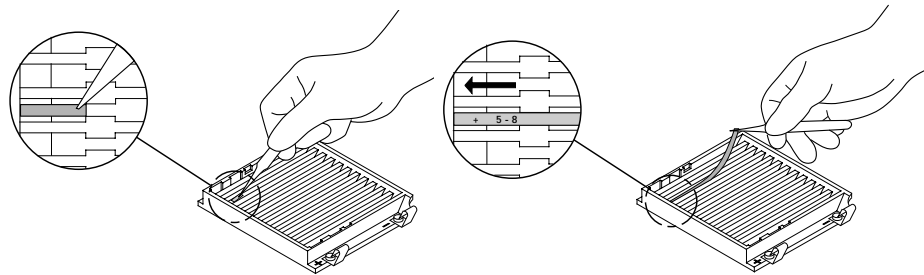

Fig. 9. Electrode wicks added to a focusing tray with IPG strips already in place.

If a rehydration/equilibration tray is used for the rehydration step place the damp electrode wicks on the electrodes of the focusing tray first (Figure 10a). Then carefully transfer the strips from the rehydration/equilibration tray placing them gel side down onto the electrode wicks in the channel of the focusing tray. (Figure 10b) Overlay each strip with mineral oil or a similar overlay material.



10a. Positioning Electrode Wick

10b. Positioning ReadyStrip IPG Strip

Fig. 10. Electrode wicks and IPG strips added to a focusing tray.

Sample application if the protein sample was not included in the rehydration buffer.

The rehydrated ReadyStrips are positioned in the focusing tray and covered with mineral oil or similar overlay material. The sample is then added to the sample loading wells on the channel in the focusing tray. The recommended sample volume for tray loading is up to 30 μ l/ReadyStrip.

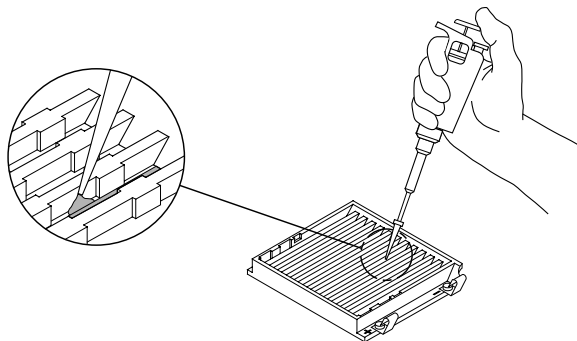

Fig. 11. Sample Application.

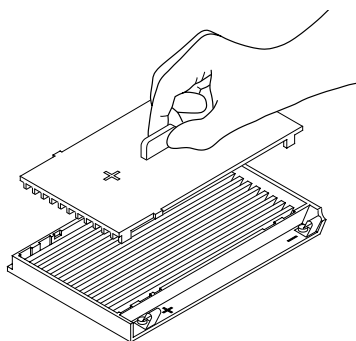

Fig. 12. Interlocking lid and tray.

Place the lid on the focusing tray so that the lid pressure tabs press on the IPG strips directly over the electrodes to insure good contact between the strips and the electrodes.

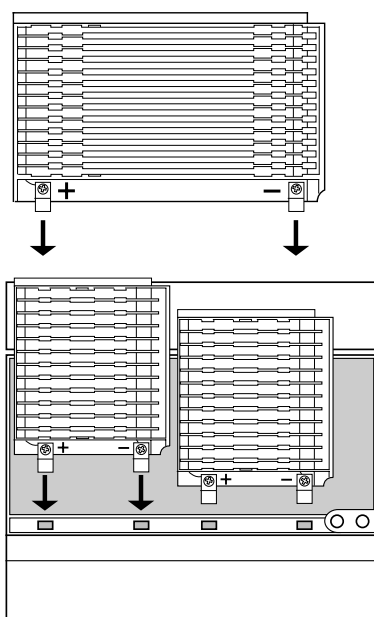

Fig. 13. Tray electrode and platform electrode alignment.

Place the tray on the Peltier platform. Be sure the electrodes of the focusing tray contact the color coded electrodes of the PROTEAN IEF cell as shown in Figure 13.

Program or select the desired method and start the run.

10.2.3. IPG Strip Storage

IPG strips can be stored indefinitely at -80 °C after the run. A rehydration tray and lid can be used to store the IPG strips.

10.2.4. IPG Strip Equilibration (prior to 2nd dimension)

To equilibrate IPG strips, fill each channel with DTT Equilibration buffer and soak for 10 minutes. Discard the solution and add the iodoacetamide equilibration solution and soak for an additional 10 minutes. Then place the IPG Strip on the second dimension gel.

Section 11 Troubleshooting

If a system or operator error occurs the appropriate error message will appear on the LCD display. The power is not applied to the system/electrodes when an error message is displayed.

Problem	Cause	Solution
Initial low or zero current	<ul style="list-style-type: none">• Poor contact between IPG strips and electrode.• Incomplete contact between tray electrodes and PROTEAN IEF Cell connections.• Incomplete IPG strip rehydration	<ul style="list-style-type: none">• Check contact between IPG strips and electrode. Make sure the focusing tray lid is placed correctly.• Check placement of focusing tray to insure proper contact between tray electrodes and PROTEAN IEF Cell connections.• Make sure that the IPG strips are completely and evenly rehydrated. Check rehydration volumes and rehydration times.
Voltage is not increasing during voltage ramping steps.	<ul style="list-style-type: none">• Salt concentration too high	<ul style="list-style-type: none">• Check salt concentration and/or desalt sample.
Voltage does not reach programmed value, or maximum voltage is reached very slowly	<ul style="list-style-type: none">• Bio-Lyte concentration too high• Set voltage too high for IPG strip size and pH gradient.• Excess sample during rehydration did not enter gel, or IPG gels overswelled with excess sample	<ul style="list-style-type: none">• Reduce Bio-Lyte concentration to 0.2% (v/v).• Program volt-hours for focusing step to insure complete focusing of sample.• If greater than recommended sample volumes are used make sure all off sample has entered gel, or remove excess sample prior to focusing.
Large fluctuations in Voltage and current. (also resistance error message displayed)	<ul style="list-style-type: none">• IPG strips contain poorly rehydrated regions, or IPG strips have dried out during the run.• Current limit too high.	<ul style="list-style-type: none">• Check rehydration volume and time. Make sure rehydration solution is evenly distributed during rehydration.• We recommend a current limit of 50 μA/strip. Make sure the correct number of IPG strips was entered.

Problem	Cause	Solution
Burning of strips (this will cause large fluctuations in resistance resulting in the resistance error message.)	<ul style="list-style-type: none"> • Current limit too high. • IPG strips have dried out. • Electrode wicks too wet or contain incorrect electrode solution. • Rehydration buffer composition incorrect, salt concentration too high. 	<ul style="list-style-type: none"> • We recommend a current limit 50 μA/strip. Make sure the correct number of IPG strips was entered. • Make sure IPG strips are covered with mineral oil or equivalent to prevent drying out • Make sure the electrode wicks contain de-ionized water only and are damp, not wet. • Check rehydration buffer concentration. Remake buffer if necessary.

Section 12 Accessories

12.1 Optional Thermal Printer

Thermal Printer can be directly used with the PROTEAN IEF Cell and comes ready to connect to the RS232 serial port. A straight, serial cable is included with the printer and the DIP switches are pre-set to match the PROTEAN IEF Cell requirements.

Configuration

The RS232 serial port	Signal and Direction	Thermal Printer
Pin 2	Transmit →	Pin 2
Pin 3	← Receive	Pin 3
Pin 5	Ground	Pin 5
other pins	Not connected	other pins

Thermal Printer

1. Insert the DC plug on the AC adaptor into the power supply jack on the printer.
2. Plug the AC adaptor into an outlet.
3. Connect the straight, serial cable to the RS232 port of the PROTEAN IEF Cell and to the serial port located on the back of the printer.
4. Load the thermal paper into the printer (refer to the Printer Manual).
5. The printer DIP switches have been preset to match the requirements of the PROTEAN IEF Cell.

To print the current DIP switch settings proceed as follows:

- a. Slide the power switch to ON while pressing the ONLINE button.
- b. Release the ONLINE button and a list of the current settings will be printed. The completed printout is followed by the prompt
"Continue?: Push On-line SW"
"Write?: Push paper feed SW"
- c. Push the Feed button to return to ONLINE Mode.

Thermal Printer Preset DIP Switch Settings (for use with the PROTEAN IEF Cell)

DIP SW-1

1	(OFF)	:	Input = Serial
2	(ON)	:	Printing Speed = High
3	(ON)	:	Auto loading = ON
4	(OFF)	:	Auto LF = OFF
5	(ON)	:	Setting Command = enable
6	(OFF)	:	Printing
7	(ON)	:	Density
8	(ON)	:	= 100%

DIP SW-2

1	(ON)	:	Printing Columns = 40
2	(ON)	:	User Font Back-up = ON
3	(ON)	:	Character Select = Normal
4	(ON)	:	Zero - Normal
5	(ON)	:	International
6	(ON)	:	Character
7	(ON)	:	Set
8	(OFF)	:	= U.S.A.

DIP SW-3

1	(ON)	:	Data Length = 8 bits
2	(ON)	:	Parity Setting = No
3	(ON)	:	Parity Condition - Odd
4	(OFF)	:	Busy Control = XON/XOFF
5	(OFF)	:	Baud
6	(ON)	:	Rate
7	(ON)	:	Select
8	(ON)	:	= 9600 bps

(Refer to the Printer Manual for details on changing the DIP switch setting)

RS232 Printout of Running Conditions

The PROTEAN IEF Cell is configured to output the running conditions every 5 minutes during the isoelectric focusing portion of a method. The printout lists the details of the programmed method and values for all the parameters of each step.

```

Bio-Rad Laboratories
PROTEAN IEF Cell
Firmware Version: X.XX

Method "Name"
Rehydration: Inactive (Passive or Active @ 50 V)
Rehyde time: 00:00 Temp: 20 °C
Run Temp: 20 °C
Number of Gels: #           Max µA/Gel: 50

Step 01      250 V Ramp:R      Time: 00:15
Step 02      10000 V Ramp:S      Time: 01:00
etc.
End of Method list.
  
```

Start of run data:

00:00	1	xxxxV /	50	10 µA	0000 V hrs
Total time elapsed	Step #	Voltage and Ramp type	Total Current	Current per gel	Total Volthours

The printout will also indicate interruptions of the run, such as pause mode and interruption of power when the cell cover is opened. If there is poor contact between one of the IPG strips and the electrode, large fluctuations in resistance will hold the voltage constant at 500 volts until the user intervenes, preventing the IPG strips from burning. If the method is edited during the run the printout will display edited values with an asterisk.

12.2 ReadyStrips IPG Strips

ReadyStrips IPG strips are made with buffering acrylamide derivatives that contain either a free carboxylic acid or a tertiary amino group which are co-polymerized with acrylamide and Bis. As such, the pH gradient is precast into the gel and cannot shift during electrophoresis. The pre-cast IPG provides reproducible gradients in an easy to use format.

Specifications	7 cm ReadyStrips	17 cm ReadyStrips
Strip dimensions		
Total strip length	7.9 cm	17.8 cm
Gel length	7.25 cm	17.1 cm
Strip width	3.3 cm	3.3 cm
Gel thickness	0.5 mm	0.5 mm
Linear pH gradient ranges		
Standard broad ranges	3-10, 4-7	3-10, 4-7
Overlapping, narrow ranges	3-6, 5-8, 7-10	3-6, 5-8, 7-10
Gel composition	4%T/3%C	4%T/3%C
Storage	-20 °C	-20 °C
Number of ReadyStrips/package	12	12
Anode (acidic) end identified by:	+	+

Refer to Section 15 for ordering information.

Section 13 Cleaning and Maintenance

Focusing/equilibration trays.

These trays are composed of polycarbonate. Clean the trays carefully with non-abrasive detergent, *e.g.* a solution of ~10% SDS, being careful not to damage the platinum electrodes. Special cleaning brushes are included with the PROTEAN IEF Cell to aid in the cleaning process. Rinse the trays thoroughly with de-ionized water to remove all detergents. Make sure the trays are completely dry prior to use.

Rehydration/equilibration trays:

These trays are composed of polystyrene and are disposable. If thoroughly cleaned as specified above, these trays can be re-used.

PROTEAN IEF Cell:

The external case is composed of an ABS/Polycarbonate blend. Do not use strong solvents to clean the PROTEAN IEF Cell. Any spills of IEF reagents on the cooling platform can be removed with paper towel

Section 14 Warranty

The PROTEAN IEF Cell is warranted for one(1) year against defects in material and workmanship. If any defects should occur during this warranty period, Bio-Rad Laboratories will replace the defective parts without charge. However, the following defects are specifically excluded:

1. Defects caused by improper operation.
2. Repair or modification done by anyone other than Bio-Rad Laboratories or their authorized agent
3. Use with other spare parts not specified by Bio-Rad Laboratories.

For inquiry or request for repair service, contact your local Bio-Rad office.

Section 15 Product Information and Accessories

Catalog Number	Product Description
165-4000	PROTEAN IEF System, complete , includes basic unit, 17 and 7 cm focusing trays with lid, 1 pack each of 17 and 7 cm rehydration/equilibration trays with lids, 2 pairs of forceps, 1 pack of electrode wicks, mineral oil, cleaning brushes
165-4001	PROTEAN IEF Cell, 90–240 VAC , basic unit, includes the cell and instruction manual
165-4010	17 cm focusing tray with lid , 1
165-4030	7 cm focusing tray with lid , 1
165-4015	Disposable rehydration/equilibration tray with lid, 17 cm , 25
165-4035	Disposable rehydration/equilibration tray with lid, 7 cm , 25

Catalog Number	Product Description
165-4070	Forceps , 1 pair
165-4071	Electrode wicks, pre-cut, 4 mm x 20 mm , 500
165-4072	Cleaning brushes , 2
165-4080	Thermal Printer, with cable and power adaptor , 100 V
165-4082	Thermal Printer , 120 V
165-4085	Thermal Printer , 220 V
170-2412	Thermal Printer Paper , 10 rolls
163-2129	Mineral oil , 500 ml
ReadyStrip™ IPG Strips	
163-2000	ReadyStrip IPG Strips pH 3-10, 7 cm , 12
163-2001	ReadyStrip IPG Strips pH 4-7, 7 cm , 12
163-2003	ReadyStrip IPG Strips pH 3-6, 7 cm , 12
163-2004	ReadyStrip IPG Strips pH 5-8, 7 cm , 12
163-2005	ReadyStrip IPG Strips pH 7-10, 7 cm , 12
163-2007	ReadyStrip IPG Strips pH 3-10, 17 cm , 12
163-2008	ReadyStrip IPG Strips pH 4-7, 17 cm , 12
163-2010	ReadyStrip IPG Strips pH 3-6, 17 cm , 12
163-2011	ReadyStrip IPG Strips pH 5-8, 17 cm , 12
163-2012	ReadyStrip IPG Strips pH 7-10, 17 cm , 12

Section 16 References

General 2D electrophoresis

1. O'Farrell P. H. (1975) High resolution two-dimensional electrophoresis of proteins., *J.Biol.Chem.* **250**, 4007–4021.

General solubilization

2. Rabilloud, T. (1996) Solubilization of proteins for electrophoretic analyses. *Electrophoresis*, **17**, 813–829.
3. Link A.J.,Ed.(1999). "2-D Proteome Analysis Protocols." *Methods in Molecular Biology*, **112**. Humana Press, Totowa, NJ.

Thiourea /TBP

4. Molloy M. P. *et.al.* (1998) Extraction of membrane proteins by differential solubilization for separation using two-dimensional gel electrophoresis. *Electrophoresis*, **19**, 837–844.
5. Herbert, B. R. *et.al.* (1998) Improved protein solubility in two-dimensional electrophoresis using tributyl phosphine as reducing agent. *Electrophoresis*, **19**, 845–851.
6. Rabilloud T. (1998) Use of thiourea to increase the solubility of membrane proteins in two dimensional electrophoresis. *Electrophoresis*, **19**, 758–760.
7. Ruedig, U. T. and Rudinger, J. (1977) Reductive cleavage of cystine disulfides with tributylphosphine, *Methods Enzymol.*, **47**, 11–116.

BIO-RAD**Bio-Rad
Laboratories**Life Science
Group

Web site www.bio-rad.com **Bio-Rad Laboratories Main Office** 2000 Alfred Nobel Drive, Hercules, CA 94547, Ph. (510) 741-1000, Fx. (510) 741-5800
Also in: **Australia** Ph. 02 9914 2800, Fx. 02 9914 2889 **Austria** Ph. (01) 877 89 01, Fx. (01) 876 56 29 **Belgium** Ph. 09-385 55 11, Fx. 09-385 65 54
Brazil Ph. 55 21 507 6191 **Canada** Ph. (905) 712-2771, Fx. (905) 712-2990 **China** Ph. 86-10-8201-1366/68, Fx. 86-10-8201-1367
Denmark Ph. 45 44 52-1000, Fx. 45 4452 1001 **Finland** Ph. 358 (0)9 804 2200, Fx. 358 (0)9 804 1100 **France** Ph. 01 47 95 69 65, Fx. 01 47 41 9133
Germany Ph. 089 318 84-177, Fx. 089 318 84-123 **Hong Kong** Ph. 852-2789-3300, Fx. 852-2789-1257 **India** Ph. (91-124)-6398112/113/114, Fx. (91-124)-6398115
Israel Ph. 03 951 4124, Fx. 03 951 4129 **Italy** Ph. 34 91 590 5200, Fx. 34 91 590 5211 **Japan** Ph. 03-5811-6270, Fx. 03-5811-6272
Korea Ph. 82-2-3473-4460, Fx. 82-2-3472-7003 **Latin America** Ph. 305-894-5950, Fx. 305-894-5960 **Mexico** Ph. 52 5 534 2552 to 54, Fx. 52 5 524 5971
The Netherlands Ph. 0318-540666, Fx. 0318-542216 **New Zealand** Ph. 64-9-4152280, Fx. 64-9-443 3097 **Norway** Ph. 47-23-38-41-30, Fx. 47-23-38-41-39
Russia Ph. 7 095 979 98 00, Fx. 7 095 979 98 56 **Singapore** Ph. 65-2729877, Fx. 65-2734835 **Spain** Ph. 34-91-590-5200, Fx. 34-91-590-5211
Sweden Ph. 46 (0)8-55 51 27 00, Fx. 46 (0)8-55 51 27 80 **Switzerland** Ph. 061-717-9555, Fx. 061-717-9550 **United Kingdom** Ph. 0800-181134, Fx. 01442-259118

Sig 1200

4006164 Rev B



Artisan Technology Group is your source for quality new and certified-used/pre-owned equipment

- FAST SHIPPING AND DELIVERY
- TENS OF THOUSANDS OF IN-STOCK ITEMS
- EQUIPMENT DEMOS
- HUNDREDS OF MANUFACTURERS SUPPORTED
- LEASING/MONTHLY RENTALS
- ITAR CERTIFIED SECURE ASSET SOLUTIONS

SERVICE CENTER REPAIRS

Experienced engineers and technicians on staff at our full-service, in-house repair center

*InstraView*SM REMOTE INSPECTION

Remotely inspect equipment before purchasing with our interactive website at www.instraview.com ↗

WE BUY USED EQUIPMENT

Sell your excess, underutilized, and idle used equipment. We also offer credit for buy-backs and trade-ins. www.artisanng.com/WeBuyEquipment ↗

LOOKING FOR MORE INFORMATION?

Visit us on the web at www.artisanng.com ↗ for more information on price quotations, drivers, technical specifications, manuals, and documentation

Contact us: (888) 88-SOURCE | sales@artisanng.com | www.artisanng.com