



Artisan Technology Group is your source for quality new and certified-used/pre-owned equipment

- FAST SHIPPING AND DELIVERY
- TENS OF THOUSANDS OF IN-STOCK ITEMS
- EQUIPMENT DEMOS
- HUNDREDS OF MANUFACTURERS SUPPORTED
- LEASING/MONTHLY RENTALS
- ITAR CERTIFIED SECURE ASSET SOLUTIONS

SERVICE CENTER REPAIRS

Experienced engineers and technicians on staff at our full-service, in-house repair center

*InstraView*SM REMOTE INSPECTION

Remotely inspect equipment before purchasing with our interactive website at www.instraview.com ↗

WE BUY USED EQUIPMENT

Sell your excess, underutilized, and idle used equipment. We also offer credit for buy-backs and trade-ins. www.artisanng.com/WeBuyEquipment ↗

LOOKING FOR MORE INFORMATION?

Visit us on the web at www.artisanng.com ↗ for more information on price quotations, drivers, technical specifications, manuals, and documentation

Contact us: (888) 88-SOURCE | sales@artisanng.com | www.artisanng.com

U S E R M A N U A L

VXI
M/MA MODULE
CARRIER

MODEL
VX405C

Manual Part No: 11027055B

COPYRIGHT

C&H Technologies, Inc. (C&H) provides this manual "as is" without warranty of any kind, either expressed or implied, including but not limited to the implied warranties of merchantability and fitness for a particular purpose. C&H may make improvements and/or changes in the product(s) and/or program(s) described in this manual at any time and without notice.

This publication could contain technical inaccuracies or typographical errors. Changes are periodically made to the information herein; these changes will be incorporated in new editions of this publication.

Copyright © 1997-2004 by C&H Technologies, Inc.

The information and/or drawings set forth in this document and all rights in and to inventions disclosed herein which might be granted thereon disclosing or employing the materials, methods, techniques, or apparatus described herein, are the exclusive property of C&H Technologies, Inc.

A Reader's Comment Form is provided at the back of this publication. If this form has been removed address comments to:

C&H Technologies, Inc.
Technical Publications
445 Round Rock West Drive
Austin, Texas 78681-5012

C&H may use or distribute any of the information you supply in any way that it believes appropriate without incurring any obligations whatever.

VME/VXI MODULE WARRANTY

C&H Technologies, Inc. warrants its VME/VXI products to be free from defects in material and workmanship for three years from date of shipment. C&H will repair or replace the defective product without charge within the warranty period, provided the defective item is shipped, freight prepaid, to C&H Technologies, at 445 Round Rock West Drive, Round Rock, Texas 78681-5012. C&H will pay return freight charges to any point in the continental United States or Canada.

Obligations under this warranty shall be limited to repair or replacement, at C&H's discretion, of any product or part thereof which has been returned by the original purchaser with transportation prepaid and, upon examination by C&H, found to be defective. C&H assumes no responsibility for loss or damage to equipment being returned for repair or replacement under the terms of this warranty. Equipment which, upon examination by C&H, requires repair or replacement of parts thereof as a result of improper installation, misuse, unauthorized alterations or repairs, or user negligence, will have such repairs or replacement of parts made at then current rates.

This warranty does not cover damage caused by misuse, neglect, accident, or improper application or installation. C&H shall not be liable for consequential damages of any kind arising out of the purchase, installation, use, or misuse of the product. C&H makes no representation or warranty of any kind, either expressed or implied, with respect to equipment operation or procedures. Any action that the user may take in reliance upon the operation or accuracy of this equipment shall be taken solely at the user's own responsibility and risk.

Please notify the C&H sales department to obtain a Return Authorization Number (RAN) prior to return of a product under the terms of this warranty. Notification is to include the Model and Serial numbers of the product along with full details of the problem. Modules returned should clearly show the RAN on the outside of the package.

AMENDMENT NOTICE

C&H Technologies, Inc. makes every attempt to provide up-to-date manuals with the associated equipment. Occasionally, changes are made to the equipment wherein it is necessary to provide amendments to the manual. For the latest version of the manual, visit the Support section of our website, www.chtech.com.

NOTE

The contents of any amendment may affect operation, maintenance, or calibration of the equipment.

INTRODUCTION

This manual describes the operation and use of the C&H Model VX405C M/MA Module Carrier (Part Number 11027050). This module is one of a number of test and data acquisition/control modules in the VME and VXI format provided by C&H. The module provides electrical and mechanical support for up to six industry standard M or MA modules (M/MAs).

Contained within this manual are the physical and electrical specifications, installation and startup procedures, functional description, and configuration and programming guidelines to adequately use the product.

Software drivers for an installed M/MA module may be provided by the M/MA module manufacturer. Some drivers may require modification to operate correctly with the installed VXI interface I/O library and the addressing methodology used by the VX405C. To support initial operation and application software development, C&H provides a software application called Interactive Mezzanine Control (IMC). The application provides immediate access and control of any M/MA module residing on a VX405C. IMC can be downloaded from the support section of C&H's website www.chtech.com.

TABLE OF CONTENTS

1.	GENERAL DESCRIPTION	1
1.1	PURPOSE OF EQUIPMENT	1
1.2	SPECIFICATIONS OF EQUIPMENT	1
1.2.1	Key Specifications.....	1
1.2.2	Electrical	1
1.2.3	Mechanical	3
1.2.4	Environmental	3
1.2.5	Bus Compliance.....	3
1.2.6	Applicable Documents	3
2.	INSTALLATION	5
2.1	UNPACKING AND INSPECTION	5
2.2	HANDLING PRECAUTIONS	5
2.3	INSTALLATION OF M/MA MODULES	5
2.4	INSTALLATION OF VX405C CARRIER	7
2.5	PREPARATION FOR RESHIPMENT	7
3.	FUNCTIONAL DESCRIPTION	8
3.1	GENERAL.....	8
3.2	INTERFACES	8
3.3	I/O AND MEMORY ADDRESSING.....	9
3.4	Triggers.....	10
3.5	INTERRUPTS	10
3.6	HARDWARE CONFIGURATION	10
3.7	INDICATORS	12
3.8	CONNECTORS	12
3.8.1	Front Panel Connector	12
3.8.2	Rear Connectors.....	12
3.8.3	+/-24V Auxiliary Connector	12
3.9	CONFIGURATION REGISTERS	13
3.9.1	VXI Configuration Registers.....	13
3.9.2	Special Function Registers	16
4.	OPERATING INSTRUCTIONS.....	17
4.1	GENERAL.....	17
4.2	HARDWARE CONFIGURATION	17
4.2.1	Logical Address Selection	17
4.2.2	Address Space Selection.....	18
4.2.3	M/MA Module Enable	18
4.3	SOFTWARE CONFIGURATION	19
4.3.1	Required Memory Setting	19
4.3.2	Triggers.....	20
4.3.3	Interrupts.....	20
4.4	M/MA Module identification	21
5.	TROUBLE ANALYSIS.....	23
5.1	BUILT IN TEST AND DIAGNOSTICS	23
5.2	TROUBLE ANALYSIS GUIDE	23
	APPENDIX A - CONNECTORS	A-1

LIST OF FIGURES

Figure 1. M/MA Configuration Diagram	6
Figure 2. Functional Block Diagram.....	8
Figure 3. Memory Organization.....	9
Figure 4. Hardware Configurable Controls	11
Figure 5. Front Panel.....	12
Figure 6. VXI Configuration Registers.....	14
Figure 7. Special Function Registers.....	16
Figure 8. Fuse Location and Values.....	24

LIST OF TABLES

Table I. Fused Level at VXI Connectors	2
Table II. Fused Level at M-Module Connectors	2
Table III. VXI Register Address Map.....	13
Table IV. M/MA Module EEPROM IDENT Words.....	21

1. GENERAL DESCRIPTION

The VX405C is a single slot, register-based, C-size, VXIbus compatible carrier module that provides electrical and mechanical support for up to six single M or MA modules (M/MAs). Each installed M/MA module appears as an independent VXI instrument to the VXI resource manager. Full VXI and MA-Module triggering and addressing is supported. For a complete list of M-modules compatible with the VX405C carrier, visit the mezzanine section of www.groupipc.com, www.mezzanines.org, or www.vita.com.

1.1 PURPOSE OF EQUIPMENT

This module provides a carrier function for a variety of plug-in modules that vary in functionality from A/D converters, digital input/output, serial interfaces, to memory devices.

1.2 SPECIFICATIONS OF EQUIPMENT

1.2.1 Key Specifications

- Supports up to six (6) ANSI/VITA 12-1996 compliant single wide M or MA-modules, or any valid combination of 2, 3, or 4 wide modules
- Supports extended M-Module functions (MA) such as extended 24-bit addressing for up to 16 Mbytes of memory, 32-bit data bus, and trigger signals for synchronization of MA-Modules
- VXI A16, A24 and A32 addressing supported
- D8, D16, and D32 accesses supported
- Individual Logical Addressing of M/MA-modules
- Isolated, filtered, and fused +5V, +12V, and -12V supplies for each M-module
- $\pm 24V$ Auxiliary Power Connector (Rev. C or higher assemblies only)
- Separate Software Programmable Interrupt Levels
- MA-Module TRIGA and TRIGB can be connected to any VXI TTL Trigger Line through software control
- M/MA Module data access time $< 800ns$
- Front panel EMI shielding
- Interactive Mezzanine Control software available

1.2.2 Electrical

The VX405C only requires the +5V power from the VXI back plane; however, $\pm 12V$ may be required by installed M-modules and $\pm 24V$ may be required if the auxiliary power connection is used. The carrier's peak module current (I_{PM}) for the +5V supply is 1.2 amps. The total available

power and the fused level of each available voltage are shown in Table I. The power available and the fused level for the M-Module positions are shown in Table II.

For electrical information on individual M/MA's, please reference each M/MA's documentation. The power requirements for each M/MA installed must be added to the VX405C's requirements for the total module's requirements.

Table I. Fused Level at VXI Connectors

	+5V	+12V	-12V	+24V	-24V
Total Available from VXI Slot ¹	7.2A	1.0A	1.0A	1.0A	1.0A
Used by VX405C internal logic	1.2A	0A	0A	0A	0A
-0001 fused level (up to Rev. D) ²	5.0A	2.5A	2.5A	1A	1A
-0001 fused level (Rev. E or higher) ³	8.0A	2.5A	2.5A	1.5A	1.5A
-0002 fused level ⁴	5.0A	2.5A	2.5A	1A	1A

Notes:

1. The total current used by the VX405C, M-Modules, and auxiliary +/-24V connector should not exceed these amounts.
2. Rev. D and below -0001 assemblies use power-off resettable fuse. At currents approaching the fused level, substantial voltage drops may be experienced.
3. Rev. E and higher -0001 assemblies use standard axial PICO style fuses. Very little voltage drop is experienced even at the fused level.
4. -0002 assemblies use power-off resettable fuses for the power from the VXI connectors.

Table II. Fused Level at M-Module Connectors

	+5V	+12V	-12V
Allowed by specification per M-Module position	1A	0.2A	0.2A
-0001 fused level per position (up to Rev. D) ¹	1.25A	0.3A	0.3A
-0001 fused level per position (Rev. E or higher) ²	1.5A	0.5A	0.5A
-0002 fused level per position	2A	1A	1A

Notes:

1. Rev. D and below -0001 assemblies use power-off resettable fuse. At currents approaching the fused level, substantial voltage drops may be experienced.
2. Rev. E and higher -0001 assemblies use standard axial PICO style fuses. Very little voltage drop is experienced even at the fused level.
3. -0002 assemblies use standard axial PICO style fuses for the power from the M-Module connector power.

1.2.3 Mechanical

The mechanical dimensions of the module are in conformance with the VXIbus specification Rev. 1.4 for single slot 'C' size modules. The nominal dimensions are 233.35 mm (9.187 in) high x 340 mm (13.386 in) deep.

1.2.4 Environmental

The environmental specifications of the module are:

Operating Temperature:	0°C to +55°C
Storage Temperature:	-40°C to +75°C
Humidity:	<95% without condensation

Installed M/MAs may differ in environmental specification. Refer to each individual M/MA's documentation for information.

1.2.5 Bus Compliance

The module complies with the VXIbus Specification Revision 1.4 for C-size register based modules and with VMEbus Specification ANSI/IEEE STD 1014-1987, IEC 821.

Manufacturer ID:	FC1 ₁₆ or VXI-IDENT value
Model Code:	FF2 ₁₆ or VXI-IDENT value
VXI Access Type:	Register Based
VXI Addressing:	A16/A24/A32
VXI Data Transfer:	D8/D16/D32
VXI Sysfail:	supported
VXI Interrupts:	ROAK or RORA, programmable levels
VXI Local Bus:	not used
TTL Triggers	SYNC trigger protocol supported
Memory Requirements:	M/MA dependent, up to 16Mbytes (VXI 32Mbytes)
M/MA-Module Compliance:	M-Module, MA-Module, A08, A24, D08, D16, D32, INTA, INTB, INTC, TRIGI, TRIGO, IDENT

1.2.6 Applicable Documents

ANSI/VITA 12-1996 American National Standard for The Mezzanine Concept
M-Module Specification, Approved May 20, 1997
VMEbus International Trade Association
7825 E. Gelding Dr. Suite 104
Scottsdale, AZ 85260-3415
E-mail: info@vita.com URL: <http://www.vita.com>

2. INSTALLATION

2.1 UNPACKING AND INSPECTION

Verify that there has been no damage to the shipping container. If damage exists, retain the container, as it will provide evidence of carrier caused problems. Such problems should be reported to the shipping courier immediately, as well as to C&H. If there is no damage to the shipping container, carefully remove the module from its box and anti-static bag and inspect for any signs of physical damage. If damage exists, report immediately to C&H.

2.2 HANDLING PRECAUTIONS

The VX405C contains components that are sensitive to electrostatic discharge. When handling the module for any reason, do so at a static-controlled workstation, whenever possible. At a minimum, avoid work areas that are potential static sources, such as carpeted areas. Avoid unnecessary contact with the components on the module.

2.3 INSTALLATION OF M/MA MODULES

M/MA modules must be installed before the VX405C is installed into the VXI system. To install modules, remove the VX405C's top shield and front panel covers as needed. ***There is never a need to remove the VX405C's bottom shield.*** Install M/MAs by firmly pressing the connector on the M/MA together with the connector on the carrier. Secure the M/MA through the holes in the bottom shield using screws provided with the M/MA. For installing M/MA modules in locations E or F, longer screws are provided (if necessary) to accommodate the standoffs required on the VX405C in those locations.

WARNING: The VX405C supports MA-Modules that use three row interface connectors. M-Modules use only two rows connectors and must be correctly positioned to use rows A and B on the carrier. When using M-Modules, row C on the VX405C is left unconnected.

There are six possible mounting locations on the carrier: A, B, C, D, E, and F. M/MA modules may be installed into any of the six locations. Locations A, B, C, and D provide direct access to the M/MA I/O connector through the front panel. M/MAs that do not require front panel access (i.e., memory or processing modules) can be easily used in locations E and F. If M/MAs in locations E and F require front panel access, location D must be left unoccupied to allow cable routing to locations E and F. Insert the three provided connector covers on location D connector pins to protect cabling to locations E and F. Use cable guides and tie downs provided to secure cabling. Configuration is illustrated in Figure 1.

CONFIGURATION FOR FOUR (4) M/MA MODULES WITH FRONT PANEL ACCESS

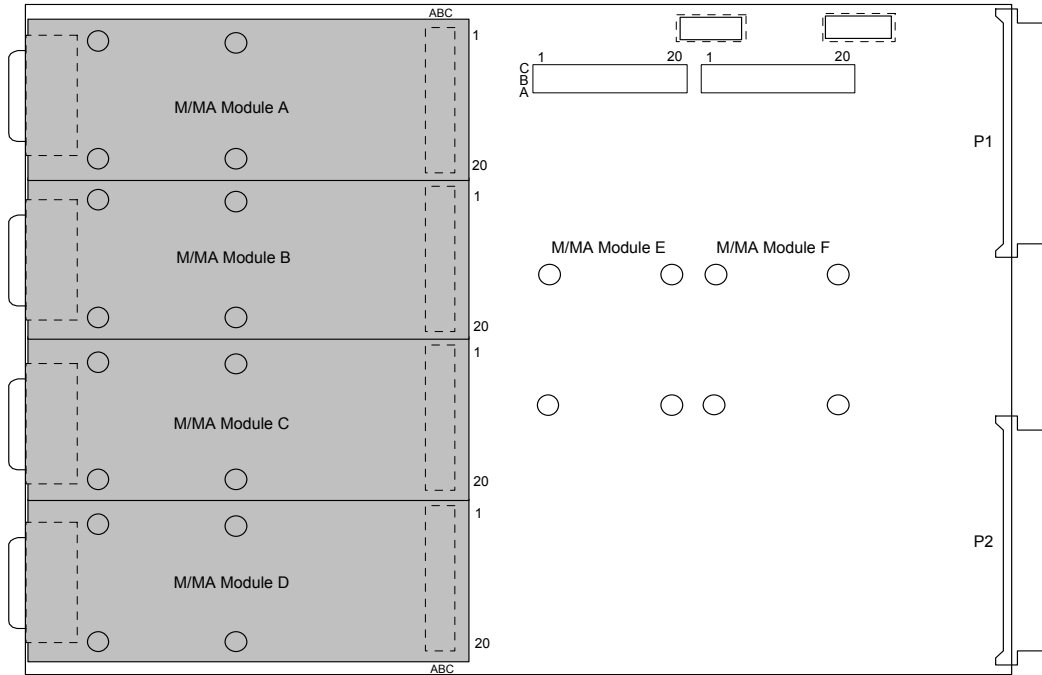

CONFIGURATION FOR FIVE (5) M/MA MODULES WITH FRONT PANEL ACCESS

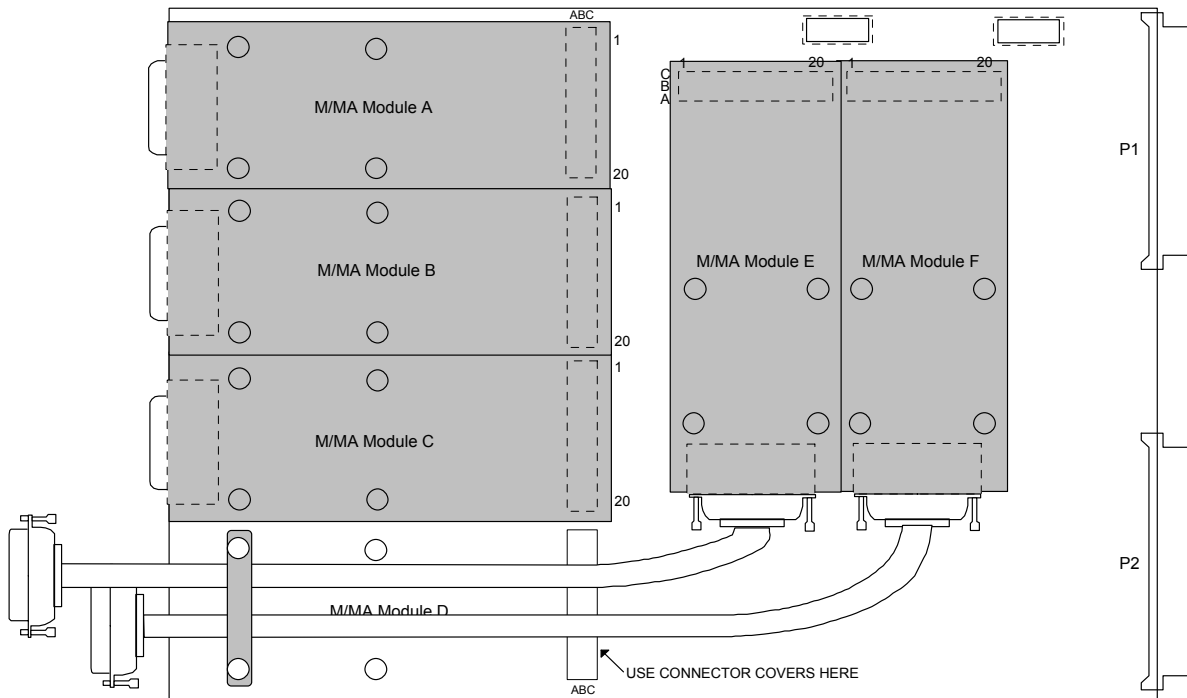

Figure 1. M/MA Configuration Diagram

CAUTION: M/MA-Module connectors are NOT keyed. Use extra caution to avoid misalignment. Applying power to a misaligned module can damage the M/MA-Module and carrier.

2.4 INSTALLATION OF VX405C CARRIER

CAUTION: Read the entire User's Manual before proceeding with the installation and application of power.

Set the module's logical address and addressing mode as described in Section 4.2.1 and 4.2.2. Insert the module into the appropriate slot according to the desired priority. Apply power. If no obvious problems exist, proceed to communicate with the module as outlined in Section 4.

2.5 PREPARATION FOR RESHIPMENT

If the module is to be shipped separately it should be enclosed in a suitable water and vapor proof anti-static bag. Heat seal or tape the bag to insure a moisture-proof closure. When sealing the bag, keep trapped air volume to a minimum.

The shipping container should be a rigid box of sufficient size and strength to protect the equipment from damage. If the module was received separately from a C&H system, then the original module shipping container and packing material may be re-used if it is still in good condition.

3. FUNCTIONAL DESCRIPTION

3.1 GENERAL

The VX405C carrier provides a mechanical and electrical interface between a VXIbus system and up to six ANSI/VITA 12-1996 standard M/MA modules. The carrier provides VXI register configuration and access to the M/MA module's I/O Space and Memory (if present). Each M/MA is controlled separately and appears as a different logical address in the VXI environment. A simplified block diagram of the module is shown in Figure 2. The VX405C has no logical address or programmable registers associated with it, thus allowing the carrier to be completely transparent in the VXI system.

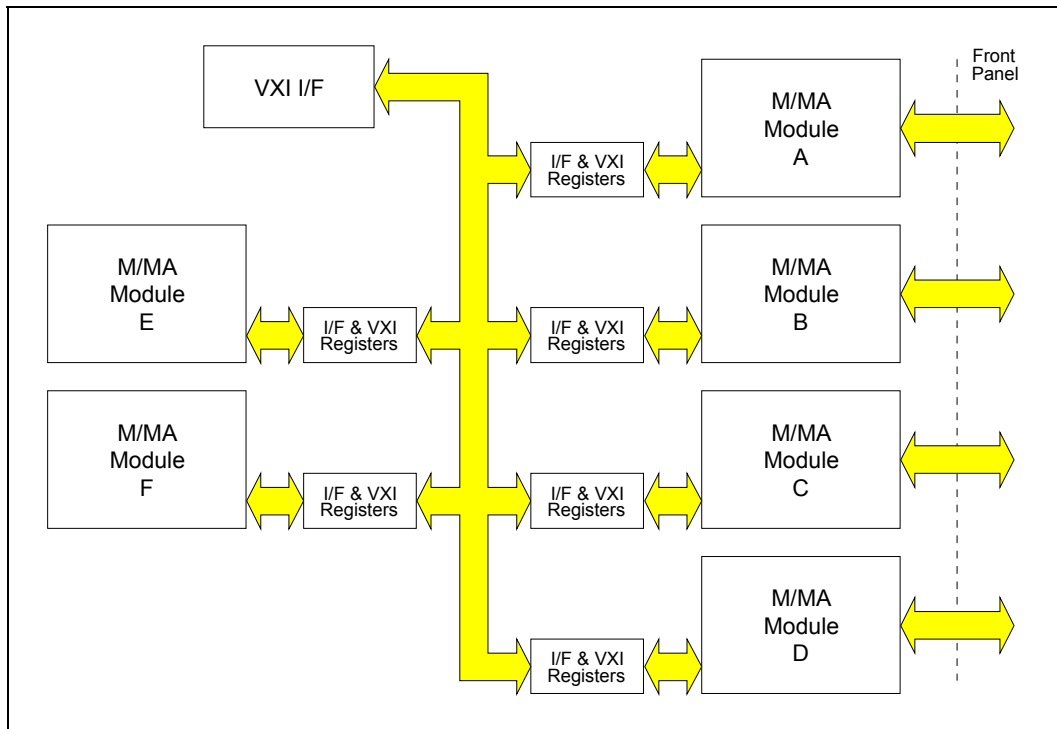

Figure 2. Functional Block Diagram

3.2 INTERFACES

The six M/MA locations interface electrically and mechanically with industry standard M/MA modules meeting the ANSI/VITA 12-1996 M-Module Specification (approved May 20, 1997). Each M/MA has its own I/O connector and is accessible through the front panel of the VX405C via the connector or a user provided cable.

3.3 I/O AND MEMORY ADDRESSING

The VX405C supports D8 (Even/Odd), D16, and D32 data access as well as A16, A24, and A32 addressing. The VXI registers of the M/MAs are accessible in the A16 address space. The VXI Offset Register is used to map the M/MA I/O Space and MA Memory (if applicable) into the A24 or A32 addressing space. For MA's that support memory, the memory begins at the mid-point of the total memory required as shown in Figure 3.

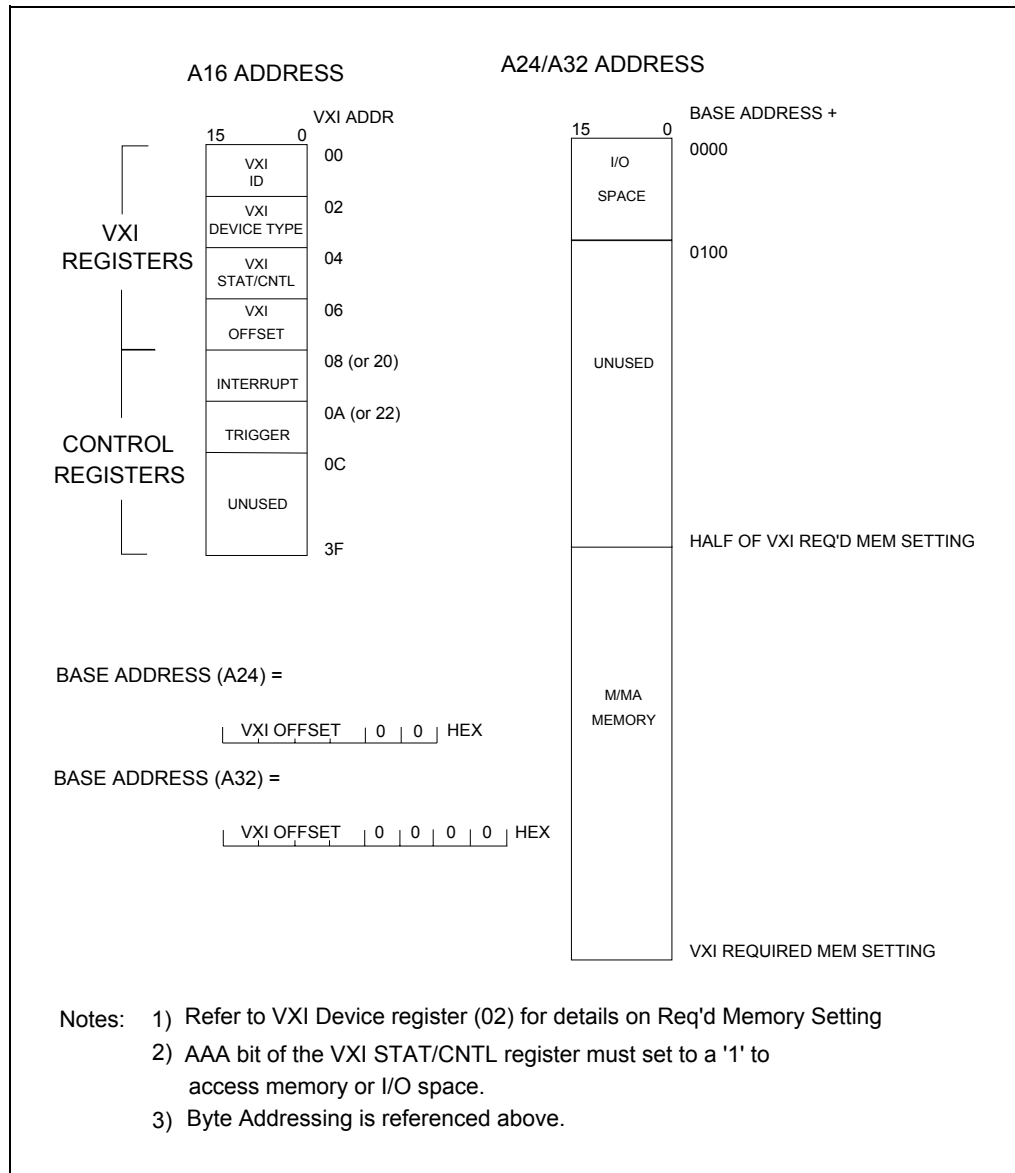

Figure 3. Memory Organization

3.4 TRIGGERS

Each M/MA is allowed two trigger lines, TRIGA and TRIGB. Triggers may be input or output. The VX405C Carrier provides software programmable connection to any VXI TTL Trigger line (SYNC Protocol). Each M/MA trigger can be enabled, logically inverted, configured as input or output, and mapped to any of the eight VXI TTL Trigger lines.

3.5 INTERRUPTS

Each M/MA can support one interrupt request as specified in the ANSI/VITA 12-1996 Specification. Each interrupt can be programmed to an individual interrupt level and is handled separately during interrupt acknowledge cycles. A hardware priority for each interrupt programmed to the same level, begins with M/MA slot A's interrupt being the highest priority and M/MA slot F's Interrupt being the lowest priority. For further detail, refer to Section 4.3.3.

3.6 HARDWARE CONFIGURATION

The logical address, address space, and positions of the occupied M/MA-module locations must be configured prior to installing the carrier into the chassis. The configuration is done using the switches described below and shown in Figure 4.

Logical Address Each M/MA location has its own logical address based on a five position address switch. The selected logical address establishes the address for position A. The other positions follow in sequential or modulo-8 order, depending on the Modulo Select switch. See Section 4.2.1 for more details.

Modulo Select This switch allows the user to set the desired numbering (sequential or modulo-8) of the logical addresses assigned to each M/MA location on the VX405C. The switch is located at position 7 of the logical address switch. For further details, refer to Section 4.2.1.

Address Space This switch selects either A24 or A32 addressing. The switch is located at position 8 of the logical address switch. For A24 addressing the switch should be set in the OPEN or '1' position.

M/MA Module Enable Six switches are provided to enable the individual M/MA locations. Each switch corresponds to an M/MA location and must be enabled before the carrier will recognize an M/MA present.

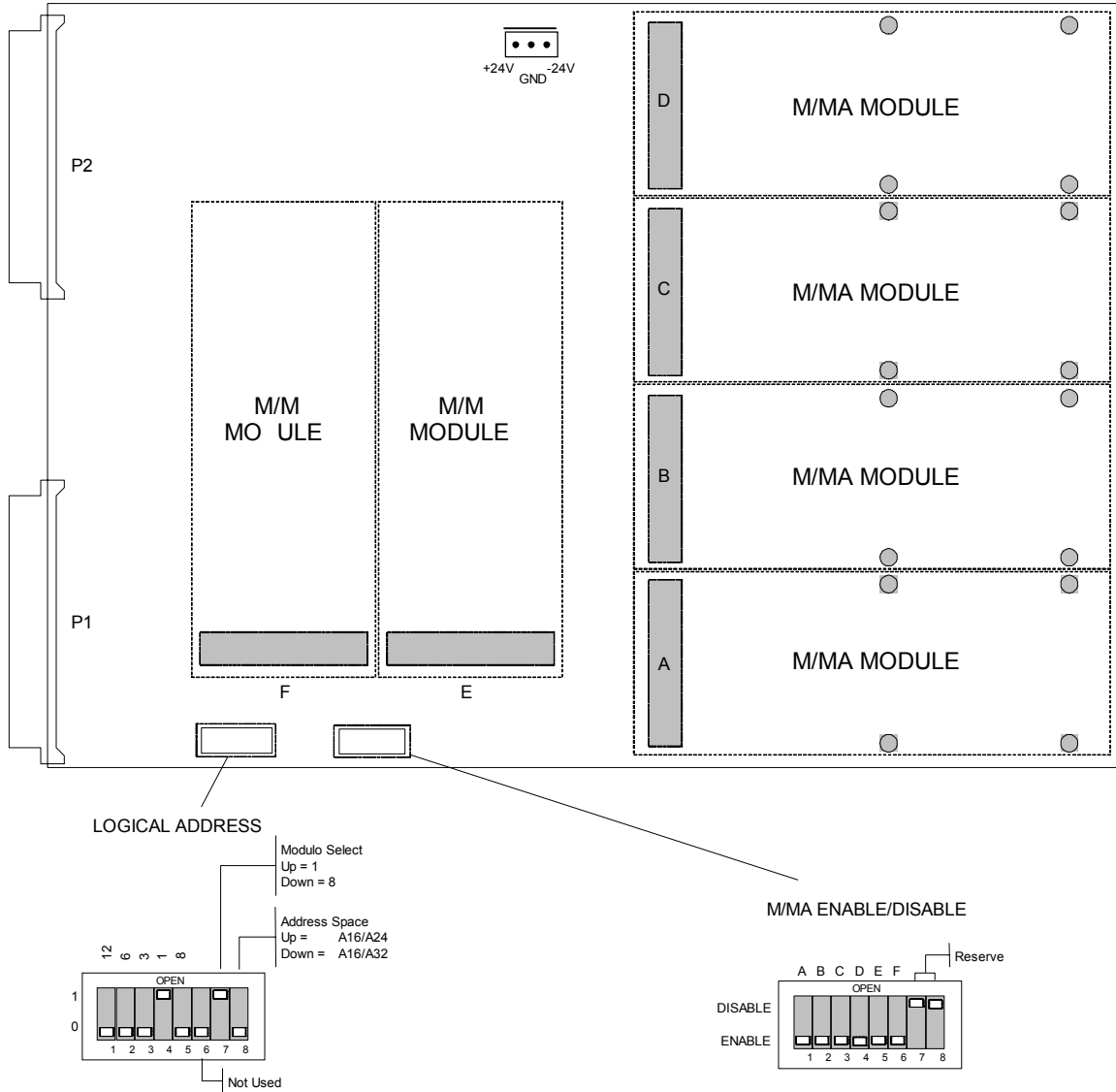

Figure 4. Hardware Configurable Controls

3.7 INDICATORS

Eight LED indicators are provided on the front panel. Their functions are:

FAIL: This front panel LED indicates the PASS/FAIL (SYSFAIL) status. The LED illuminates during reset, initialization, or if there is a failure on the VX405C Carrier itself.

ID: This front panel LED illuminates whenever the host processor applies the MODID signal to the slot the module is occupying.

A, B, C, D, E, F: These front panel LEDs illuminate whenever that M/MA is properly accessed by the host processor.

3.8 CONNECTORS

3.8.1 Front Panel Connector

The front panel connectors come directly from the M/MAs themselves, therefore they are M/MA dependent. Front panel covers are provided to close front panel openings on any unused M/MA locations. The covers should be used to control airflow and EMI leakage when there is no M/MA module installed.

3.8.2 Rear Connectors

The P1 and P2 connectors are configured in accordance with the VXI specification. (See APPENDIX A)

3.8.3 +/-24V Auxiliary Connector

The auxiliary +/-24V connector is shown in Figure 4. (1A max. on each)

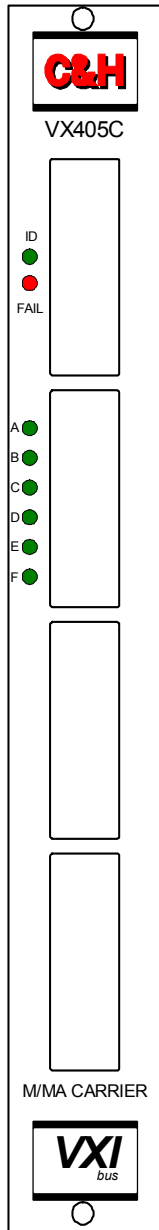

Figure 5. Front Panel

3.9 CONFIGURATION REGISTERS

There are a variety of registers used to configure and control the VX405C module. The VXI configuration registers provide for control and status as required by the VXIbus specification. An address map of the registers is shown in Table III.

Table III. VXI Register Address Map

A16 Address	Register Description
Base + 00	VXI ID
Base + 02	VXI Device Type
Base + 04	VXI Status/Control
Base + 06	VXI Offset Register
Base + 08 (or 20)	Interrupt Control Register
Base + 0A (or 22)	Trigger Control Register

3.9.1 VXI Configuration Registers

The VXI configuration registers contain basic information needed to configure a VXIbus system. The configuration information includes: manufacturer identification, product model code, device type, memory requirements, device status, and device control. The registers are briefly described below and are detailed in Figure 6.

VXI Identification (ID) Register (Base + 00₁₆) This read-only register provides the manufacturer identification, device classification (i.e., register based), and the addressing mode (i.e. A32).

VXI Device Type Register (Base + 02₁₆) This read/write register provides the model code (see note) identifier and allows the user to set the M/MA's required memory.

Note: The manufacturer and model code identification depends on the installed M/MA-Module's support of the VXI extension to the optional M-Module IDENT function. For modules that support the VXI IDENT extension (non-standard), the manufacturer and model code of the M/MA-Module is reported and the required memory is automatically set according to the M/MA-Module requirements. For all other modules, C & H Technologies (FC1₁₆) is reported as the manufacturer and the VX405C (FF2₁₆) as the model code. Additionally, the user may have to set the required memory. Refer to M/MA Module identification for details on the VXI INDENT Extension.

VXI Status/Control Register (Base + 04₁₆) A read of this register provides the state of the P2 MODID* line and the SYSFAIL inhibit, ready and self-test status. A write to this register allows disabling of the SYSFAIL function and individual reset of the associated M/MA module.

VXI Offset Register (Base + 06₁₆) This read/write register controls the offset value for addressing the M/MA I/O space and memory. The VXI system resource manager or control module sets this value according to the memory requirements specified for this module and the memory requirements of the other instruments in the system.

VXI ID

00	Bit	15	14	13	12	11	10	9	8	7	6	5	4	3	2	1	0
Read Only		Device Class		Address Space		Manufacturer ID											

Device Class ⇒ Device Class (11 = Register Based)

Address Space ⇒ Address Space (00 = A16/A24, 01 = A16/A32, 10 = reserved, 11 = A16 Only)

Manuf. ID ⇒ Manufacturer Identification (see text for details)

VXI Device Type

02	Bit	15	14	13	12	11	10	9	8	7	6	5	4	3	2	1	0	
Write		Required Memory																
Read		Required Memory					Model Code											

Model Code ⇒ Model code (see text for details)

Required Memory ⇒ Required memory (value depends on memory required by M/MA module and VXI address space setting, see table below)

<u>Mem Rq'd by M/MA</u>	<u>A32 Address Space</u>	<u>A24 Address Space</u>
0 bytes	F (64K)	E (512 bytes)
128 bytes	F (64K)	E (512 bytes)
256 bytes	F (64K)	E (512 bytes)
512 bytes	F (64K)	D (1K)
1K	F (64K)	C (2K)
2K	F (64K)	B (4K)
4K	F (64K)	A (8K)
8K	F (64K)	9 (16K)
16K	F (64K)	8 (32K)
32K	F (64K)	7 (64K)
64K	E (128K)	6 (128K)
128K	D (256K)	5 (256K)
256K	C (512K)	4 (512K)
512K	B (1M)	3 (1M)
1M	A (2M)	2 (2M)
2M	9 (4M)	1 (4M)
4M	8 (8M)	0 (8M)
8M	7 (16M)	-
16M	6 (32M)	-

Figure 6. VXI Configuration Registers

VXI Status/Control

04	Bit	15	14	13	12	11	10	9	8	7	6	5	4	3	2	1	0
Write	AAA	-	-	1	1	1	1	1	1	1	1	1	1	-	-	SI	RST
Read	AAA	MID	CSE	1	1	1	1	1	1	1	1	1	1	RDY	Pass	0	0

AAA ⇒ A24/A32 Access (0 = disabled)

MID ⇒ Module ID Status (0 = P2 MODID* line is selected)

CSE ⇒ Check Sum Error. (0 = error reading non-volatile memory during power-up. Reset on read, 1 = OK)

RDY ⇒ Ready (1 = ready)

Pass ⇒ Pass/fail indicator (0 = executing or failed, 1 = passed)

SI ⇒ Sysfail Inhibit (1 = inhibit, see note)

RST ⇒ Reset (writing a '1' to this bit resets the M module; after a minimum of 100 µs a '0' must be written to resume normal operation)

Note: The Sysfail Inhibit is a VXI slot inhibit; therefore setting the inhibit bit on any M/MA module will inhibit SYSFAIL on all M/MA modules.

VXI Offset Register

06	Bit	15	14	13	12	11	10	9	8	7	6	5	4	3	2	1	0
Write	Offset Value																
Read	Offset Value																

Offset Value ⇒ Offset to M/MA's I/O Space and Memory (if applicable)

Figure 6. VXI Configuration Registers (continued)

3.9.2 Special Function Registers

Interrupt Control Register (base + 08₁₆ or base + 20₁₆) This read/write register sets the interrupt level, and provides the upper byte of vector for M/MA interrupt types INTA and INTB.

Trigger Control Register (base + 0A₁₆ or base + 22₁₆) This read/write register selects a VXI TTL Trigger line for the TRIGA and TRIGB functions, and sets them as input or output using the VXI TTLTRG Synchronous (SYNC) Trigger Protocol.

		Interrupt Control Register															
		15	14	13	12	11	10	9	8	7	6	5	4	3	2	1	0
Write		Interrupt Vector								-	-	IDC	IT	IVE	Interrupt Level		
Read		Interrupt Vector								-	-	IDC	IT	IVE	Interrupt Level		

Interrupt Vector ⇒ Upper 8 bits of the interrupt vector for type INTA and INTB interrupts. Default = 0.

IDC ⇒ Interrupt DTACK Control (0 = wait for response from M-module during IACK cycle, 1 = ignore response from M-module during IACK cycle) Default = 0

IT ⇒ Interrupt Type (0 = follows interrupt type used by installed M-Module, 1 = ROAK regardless of M-Module interrupt type) Default = 0

Interrupt Level ⇒ Interrupt Level for the M/MA interrupt. Level of '0' disables the interrupt. Default = disabled.

IVE ⇒ Interrupt vector enable (0 = returns the interrupt vector programmed in this register, 1 = returns the M-module vector, if supported by the M-module). Default = 1.

		Trigger Control Register															
		15	14	13	12	11	10	9	8	7	6	5	4	3	2	1	0
Write		BEN	BDIR	BINV	-	-	Trig B TTL Sel	AEN	ADIR	AINV	-	-	Trig A TTL Sel				
Read		BEN	BDIR	BINV	-	-	Trig B TTL Sel	AEN	ADIR	AINV	-	-	Trig A TTL Sel				

AEN ⇒ Trigger enable for Trig A (1 = enable, 0= disable). Default = disable.

ADIR ⇒ Trigger direction for Trig A (0 = input (VXI to M-Module), 1 = output (M-Module to VXI)). Default = input.

AINV ⇒ Trig A invert bit. (1 = invert logical level of input or output trigger A). Default = 0, non-inverting.

Trig A TTL Sel ⇒ Trigger A Mapping to VXI TTL Trigger lines 0 -7. Default = 0.

BEN ⇒ Trigger enable for Trig B (1 = enable, 0= disable). Default = disable.

BDIR ⇒ Trigger direction for Trig B (0 = input (VXI to M-Module), 1 = output (M-Module to VXI)). Default = input.

BINV ⇒ Trig B invert bit. (1 = invert logical level of input or output trigger B). Default = 0, non-inverting.

Trig B TTL Sel ⇒ Trigger B Mapping to VXI TTL Trigger lines 0 -7. Default = 0.

Figure 7. Special Function Registers

4. OPERATING INSTRUCTIONS

4.1 GENERAL

The VX405C is configured through a series of hardware switches and software controlled registers as below. The switches enable the M/MA slots and configure the logical addresses of the M/MAs. The VX405C has software controlled registers for each module. These registers provide configuration of interrupts, triggers, A24/A32 addressing, and required memory. All other M/MA controls are dependent on a specific M/MA and reside on that module (in I/O and memory space).

4.2 HARDWARE CONFIGURATION

CAUTION: All hardware configurations must be done only while the power to the module is OFF.

4.2.1 Logical Address Selection

The logical address is set for each M/MA module by selecting the starting logical address and the desired sequencing (sequential or multiple of 8) of addressing using the toggle switches provided on the carrier. With sequential logical addressing (Modulo Select switch in the Up position), the starting logical address can be selected as any multiple of 8 (i.e., 8, 16, ..., or 248). The M/MA in location A is assigned the starting logical address and the remaining locations (enabled or disabled) are assigned logical addresses in sequential order (i.e., 8, 9, 10, etc.). With Modulo-8 logical addressing (Modulo Select switch in the Down position), the starting logical address can be selected as any multiple of 64 (i.e., 64, 128, or 192). The M/MA in location A is assigned the starting logical address and the remaining locations (enable or disabled) are assigned logical addresses in multiples of eight (i.e., 64, 72, 80, etc.). A disabled M/MA location is still counted when determining the logical address of the enabled locations; however, the disabled location will not respond when queried by the resource manager and the logical address can be used elsewhere in the system.

Care should be taken to ensure that none of the modules have the same logical address as another module in the VXI system. Position 1 on the switch is the most significant bit and has a weighted value of 128 when the switch is in the OPEN position. Position 5 on the switch is the least significant bit and has a weighted value of 8 when the switch is in the OPEN position. It is important to note that if the modulo select switch is set to '8' (the DOWN position), only logical address switch settings of 64, 128, 192 are valid. The sum of the weighted values of all the switches in the OPEN position, along with the values in the table below, give the M/MAs' logical address.

Example of sequential addressing:

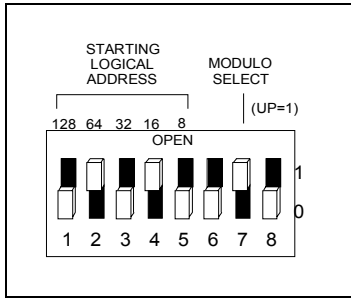

With the above switch settings, the starting logical address is $64 + 16 = 80$ and the logical addresses would be assigned as follows:

M/MA Location	Location Enabled	Assigned Logical Address
A	Yes	80
B	Yes	81
C	Yes	82
D	No	unassigned
E	No	unassigned
F	Yes	85

Example of Modulo-8 addressing:

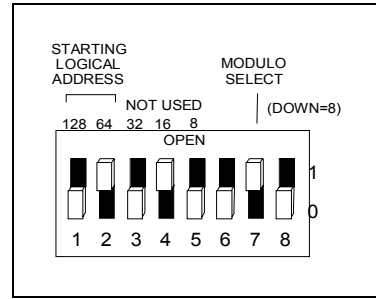

With the above switch settings, the starting logical address is 64 and the logical addresses would be assigned as follows:

M/MA Location	Location Enabled	Assigned Logical Address
A	Yes	64
B	Yes	72
C	Yes	80
D	No	unassigned
E	No	unassigned
F	Yes	104

4.2.2 Address Space Selection

A single switch is provided that selects either VXI A16/A24 or A16/A32 addressing for the entire carrier. This switch is located in position 8 of the logical address switch. The UP (OPEN) position of this switch corresponds to A16/A24 and the DOWN position to A16/A32.

4.2.3 M/MA Module Enable

Six switches are provided to enable the individual M/MA locations. Each switch represents an M/MA location and must be enabled before the carrier will recognize a module as present. These switches are positions 1 - 6 of the M/MA switch and correspond to M/MA locations A - F respectively. With the switch in the UP (OPEN) position, the M/MA in that location is disabled. Conversely, with the switch is in the DOWN position, the M/MA in that location is enabled. **Switch positions 7 & 8 are reserved for test purposes and must be in the DOWN position for normal operation.**

4.3 SOFTWARE CONFIGURATION

4.3.1 Required Memory Setting

The amount of memory space allocated for a module by the system resource manager or control module is specified in the Required Memory field of the VXI Device Type register (0x02). The default Required Memory setting is the minimum amount allowed by the VXI address space selected. A24 addressing allows a minimum of 512 bytes and A32 addressing allows a minimum of 64Kbytes.

Note: In order to access the M/MA-Module IO Space and memory, the AAA bit in the VXI Status/Control register (0x04) must be set high. This is usually done by the resource manager after allocating memory.

For M-Modules that have only IO Space (256 bytes), the default Required Memory setting is sufficient and no changes to this field are required.

For MA-Modules that have on-board memory, the Required Memory field must be changed to cause the resource manager to allocate enough memory space for the IO Space and memory contained on the MA-Module. Since the VX405C maps a MA-Module's IO Space into the lower 256 bytes of the allocated memory space and the MA-Module's memory into the upper half of the allocated memory space, the VXI Required Memory must be set to twice the MA-Modules required memory.

For example, if an MA-Module has 512Kbytes of on-board memory, then 1Mbyte of VXI memory space must be allocated. The module's 256 bytes of IO Space is mapped starting at the *Offset* + 0x000000 (A24) and the 512Kbytes of memory begins at the *Offset* + 0x080000 (A24). Proper settings are given in the table provided under the VXI Device Type register description in Figure 6.

To change the Required Memory field, simply write the new value to VXI Device Type register. The Model Code bits are ignored. The new setting is stored in non-volatile memory and will remain the set value until it is changed again. When the required memory bits are written, the VX405C must be **powered off** and a resource manager re-ran before the change will take effect. *Due to the required memory setting being stored in non-volatile memory, a short amount of time is required before the VXI Device Type Register can be accessed again after a write. During this time, the VXI Ready Bit is cleared in the VXI Status/Control Register (0x04), and then set back to '1' when access to the VXI Device Type Register is permitted.*

Note: If the installed M/MA-Module supports the VXI IDENT extension (non-standard) to the optional M-Module IDENT function, the required memory is automatically set according to the M/MA-Module requirements. Refer to M/MA Module identification for details on the VXI IDENT Extension.

4.3.2 Triggers

If the TRIGI or TRIGO functions are supported by an M/MA, any of the eight VXI TTL Trigger lines can be connected as either an input or output to TRIGA or TRIGB of the M/MA. A software programmable register (0x0A or 0x22) is provided for each M/MA to connect TRIGA and TRIGB individually to a VXI TTL Trigger line. Both TRIGA and TRIGB can be individually enabled and set as input or output as described in Figure 7. An inversion bit is also provided to allow the user to configure the trigger for a rising or falling edge. All M/MAs on the carrier can be connected to the same VXI TTL Trigger line to synchronize the M/MAs.

4.3.3 Interrupts

The ANSI/VITA 12-1996 M-Module Specification specifies that an M/MA module may generate an interrupt. The VXI interrupt level is programmed by writing the desired level into the Interrupt Level field of the Interrupt Control Register (0x08 or 0x20). Writing a zero to the Interrupt Level field disables the interrupt for that M/MA.

M/MA modules can support Type A, B, or C interrupts. A Type A interrupter requires software to access the module to release the interrupt request, sometimes referred to as release on register access (RORA). A Type B interrupter releases the interrupt request during the hardware interrupt acknowledge cycle sometimes referred to as release on acknowledge (ROAK). A Type C interrupter is the same as a Type B interrupter, except the M/MA module also supplies an interrupt vector during the interrupt acknowledge cycle.

Type A and B interrupters must use the software programmable Interrupt Vector field of the Interrupt Control Register (0x08) for the upper byte of the VXI interrupt vector (VXI Status/ID) during the interrupt acknowledge cycle. To enable this action, set the IVE bit to 0 in the Interrupt Control Register. The lower byte of the interrupt vector is the logical address of the M/MA module. Type C interrupters provide their own upper byte of the interrupt vector during the interrupt acknowledge cycle.

The VXI specification recommends that VXI modules use the ROAK interrupt protocol. This recommendation can be supported by using an M/MA module that uses Type B or Type C interrupts or by simply setting the interrupt type (IT) bit to a 1 in the Interrupt Control register. Setting the IT bit to 1 will cause the VX405C to release the VXI interrupt request during the hardware acknowledge cycle, regardless of the interrupt type used by M/MA module. For Type A interrupters, the VX405C will release the interrupt request to the VXI during the interrupt acknowledge cycle, but the interrupt from the M/MA will still be pending until the appropriate IO register is accessed. The IDC bit may need to be set to a 1 to ignore the response from the M-module during the interrupt acknowledge cycle. The VX405C will not issue another interrupt to the VXI from that M/MA until the M/MA's interrupt is cleared.

4.4 M/MA MODULE IDENTIFICATION

The ANSI/VITA 12-1996 M-Module Specification allows for an optional identification function called IDENT. This IDENT function provides information about the M/MA module and is stored in sixteen word deep (32 byte) serial EEPROM. Access is accomplished with read/write operations on the last address in I/O space and the data is read one bit at a time. Access to the IDENT is only guaranteed after a reset is performed.

The VX405C also supports the optional VXI-IDENT function introduced by Hewlett-Packard. This optional function is not part of the approved ANSI/VITA 12-1996 standard. This extension to the M-module IDENT function increases the size of the EEPROM to at least 64 words (128 bytes) and includes VXI compatible ID and Device Type registers. Details are shown in Table IV. The VX405C automatically checks the M/MA-Module for support of this optional function during power-up. If the VX405C detects support, then the VXI Manufacturer ID in the VXI ID register and the Required Memory and Model Code in the VXI Device Type register are changed to reflect the settings provided by the M/MA-Module.

Table IV. M/MA Module EEPROM IDENT Words

Word	Description	Value (hex)
0	Sync Code	5346
1	Module Number	(Module Dependent)
2	Revision Number	(Module Dependent)
3	Module Characteristics	(Module Dependent)
4-7	Reserved	
8-15	M-Module Specific	(Module Dependent)
16	VXI Sync Code	ACBA
17	VXI ID	VXI Manufacturer ID
18	VXI Device Type	Req'd Mem/Model Code
19-31	Reserved	
32-63	M-Module Specific	(Module Dependent)

Note: The VXI Device Type word contains two fields, bits 0-11 are the Model Code and bits 12-15 are the Required Memory, where:

Req'd Mem $\Rightarrow 2^{(23-m)}$, where m is the value of the four bits

Model Code \Rightarrow manufacturer specified model number

5. TROUBLE ANALYSIS

5.1 BUILT IN TEST AND DIAGNOSTICS

During power-up initialization, a basic built-in test function is performed. If an initialization failure is detected, the SYSFAIL lamp will light indicating a failure. Sysfail Inhibit can be used to help isolate the cause of the failure. **The Sysfail Inhibit is a VXI slot inhibit; therefore setting the inhibit bit on any M/MA module will inhibit SYSFAIL on all M/MA modules.**

5.2 TROUBLE ANALYSIS GUIDE

The following is a general guide of the most common problems that may be encountered with the VX405C, along with a suggestion of the possible causes.

SYMPTOMS

POSSIBLE CAUSES

Bus time out on A16 Access

1. Logical address incorrectly set.
2. Card incorrectly installed.
3. M/MA enable switch not enabled.
4. Logical address Modulo Select switch not set as expected.
5. Blown fuse (see Figure 8)

Unable to access M/MA memory/IO space

1. Attempting to access an improper address.
2. VXI memory setting for that M/MA not set to $2 \times$ M/MA's required memory.
3. AAA bit in the Status/Control register not set to allow A32/A24 addressing.
4. A24/A32 switch set improperly.
5. Offset register not set correctly.

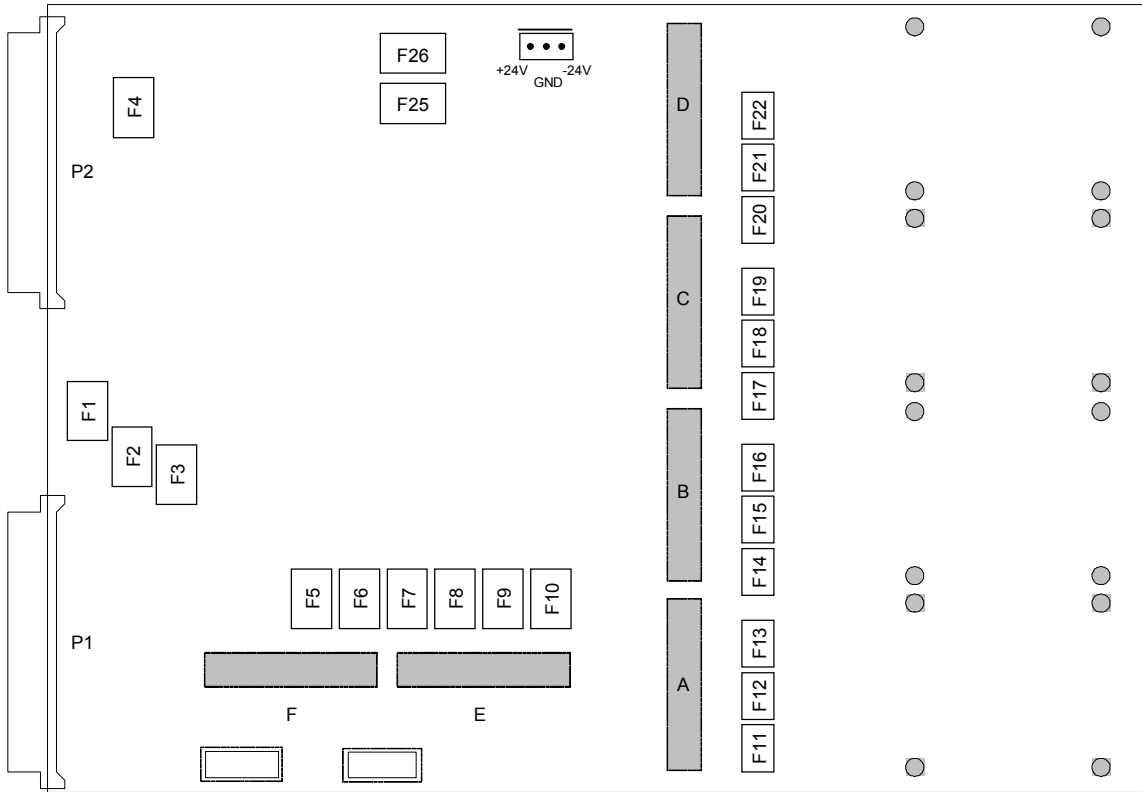

Fuse Ref	-0001	-0002
F1	2.5A	SR
F2	2.5A	SR
F3	4A	SR
F4	4A	SR
F5	0.5A	1A
F6	0.5A	1A
F7	1.5A	2A
F8	0.5A	1A
F9	0.5A	1A
F10	1.5A	2A
F11	1.5A	2A
F12	0.5A	1A

Fuse Ref	-0001	-0002
F13	0.5A	1A
F14	1.5A	2A
F15	0.5A	1A
F16	0.5A	1A
F17	1.5A	2A
F18	0.5A	1A
F19	0.5A	1A
F20	1.5A	2A
F21	0.5A	1A
F22	0.5A	1A
F25	1.5A	SR
F26	1.5A	SR

Notes:

1. Table is for -0001 Rev. E assemblies or higher and all revisions of -0002 assemblies.
2. SR = power-off self-resetting fuses
3. All non-SR fuses are miniature PICO II axial fuses rated at 125V or higher.

Figure 8. Fuse Location and Values

APPENDIX A - CONNECTORS

PIN	C	B	A
1	D08	-	D00
2	D09	-	D01
3	D10	-	D02
4	D11	BG0IN*	D03
5	D12	BG0OUT*	D04
6	D13	BG1IN*	D05
7	D14	BG10UT*	D06
8	D15	BG2IN*	D07
9	GND	BG20UT*	GND
10	SYSFAIL*	BG3IN*	-
11	-	BG3OUT*	-
12	SYSRESET*	-	DS1*
13	LWORD*	-	DS0*
14	AM5	-	WRITE*
15	A23	-	-
16	A22	AM0	DTACK*
17	A21	AM1	-
18	A20	AM2	-
19	A19	AM3	-
20	A18	GND	IACK*
21	A17	-	IACKIN*
22	A16	-	IACKOUT*
23	A15	GND	AM4
24	A14	IRQ7*	A07
25	A13	IRQ6*	A06
26	A12	IRQ5*	A05
27	A11	IRQ4*	A04
28	A10	IRQ3*	A03
29	A09	IRQ2*	A02
30	A08	IRQ1*	A01
31	+12 V	-	-12 V
32	+5 V	+5 V	+5 V

Figure A-1. P1 Pin Configuration

PIN	C	B	A
1	-	+5V	-
2	-	GND	-
3	GND	-	-
4	-	A24	GND
5	-	A25	-
6	-	A26	-
7	GND	A27	-
8	-	A28	-
9	-	A29	-
10	GND	A30	GND
11	-	A31	-
12	-	GND	-
13	-	+5V	-
14	-	D16	-
15	-	D17	-
16	GND	D18	GND
17	-	D19	-
18	-	D20	-
19	-	D21	-
20	-	D22	-
21	-	D23	-
22	GND	GND	GND
23	TTLTRG1*	D24	TTLTRG0*
24	TTLTRG3*	D25	TTLTRG2*
25	GND	D26	+5V
26	TTLTRG5*	D27	TTLTRG4*
27	TTLTRG7*	D28	TTLTRG6*
28	GND	D29	GND
29	-	D30	-
30	GND	D31	MODID
31	-	GND	GND
32	-	+5V	-

Figure A- 2. P2 Pin Configuration

NOTES :

READER'S COMMENT FORM

Your comments assist us in improving the usefulness of C&H's publications; they are an important part of the inputs used for revision.

C&H Technologies, Inc. may use and distribute any of the information that you supply in any way that it believes to be appropriate without incurring any obligation whatsoever. You may, of course, continue to use the information which you supply.

Please refrain from using this form for technical questions or for requests for additional publications; this will only delay the response. Instead, please direct your technical questions to your authorized C&H representative.

COMMENTS:

Thank you for helping C&H to deliver the best possible product. Your support is appreciated.

Sincerely,

F.R.Harrison
President and CEO

INSTRUCTIONS

In its continuing effort to improve documentation, C&H Technologies, Inc. provides this form for use in submitting any comments or suggestions that the user may have. This form may be detached, folded along the lines indicated, taped along the loose edge (DO NOT STAPLE), and mailed. Please try to be as specific as possible and reference applicable sections of the manual or drawings if appropriate. Also, indicate if you would like an acknowledgment mailed to you stating whether or not your comments were being incorporated.

NOTE: This form may not be used to request copies of documents or to request waivers, deviations, or clarification of specification requirements on current contracts. Comments submitted on this form do not constitute or imply authorization to waive any portion of the referenced document(s) or to amend contractual requirements.

————— (Fold along this line) —————

————— (Fold along this line) —————

Place Stamp Here

C&H Technologies, Inc.
Technical Publications
445 Round Rock West Drive
Austin, Texas 78681-5012



Artisan Technology Group is your source for quality new and certified-used/pre-owned equipment

- FAST SHIPPING AND DELIVERY
- TENS OF THOUSANDS OF IN-STOCK ITEMS
- EQUIPMENT DEMOS
- HUNDREDS OF MANUFACTURERS SUPPORTED
- LEASING/MONTHLY RENTALS
- ITAR CERTIFIED SECURE ASSET SOLUTIONS

SERVICE CENTER REPAIRS

Experienced engineers and technicians on staff at our full-service, in-house repair center

*InstraView*SM REMOTE INSPECTION

Remotely inspect equipment before purchasing with our interactive website at www.instraview.com ↗

WE BUY USED EQUIPMENT

Sell your excess, underutilized, and idle used equipment. We also offer credit for buy-backs and trade-ins. www.artisanng.com/WeBuyEquipment ↗

LOOKING FOR MORE INFORMATION?

Visit us on the web at www.artisanng.com ↗ for more information on price quotations, drivers, technical specifications, manuals, and documentation

Contact us: (888) 88-SOURCE | sales@artisanng.com | www.artisanng.com