



## Artisan Technology Group is your source for quality new and certified-used/pre-owned equipment

- FAST SHIPPING AND DELIVERY
- TENS OF THOUSANDS OF IN-STOCK ITEMS
- EQUIPMENT DEMOS
- HUNDREDS OF MANUFACTURERS SUPPORTED
- LEASING/MONTHLY RENTALS
- ITAR CERTIFIED SECURE ASSET SOLUTIONS

### SERVICE CENTER REPAIRS

Experienced engineers and technicians on staff at our full-service, in-house repair center

### *InstraView*<sup>SM</sup> REMOTE INSPECTION

Remotely inspect equipment before purchasing with our interactive website at [www.instraview.com](http://www.instraview.com) ↗

### WE BUY USED EQUIPMENT

Sell your excess, underutilized, and idle used equipment. We also offer credit for buy-backs and trade-ins. [www.artisanng.com/WeBuyEquipment](http://www.artisanng.com/WeBuyEquipment) ↗

### LOOKING FOR MORE INFORMATION?

Visit us on the web at [www.artisanng.com](http://www.artisanng.com) ↗ for more information on price quotations, drivers, technical specifications, manuals, and documentation

**Contact us:** (888) 88-SOURCE | [sales@artisanng.com](mailto:sales@artisanng.com) | [www.artisanng.com](http://www.artisanng.com)

- **MOSFET Output**
- **Low On-State Resistance**
- **Paralleling Capability for Higher Currents**
- **Panel Mount**

DC output relays feature MOSFET technology for low on-state resistance, assuring easy paralleling and switching capabilities to 40 amps at 100 Vdc. Lower current models are also available to 500 Vdc. All models come in Crydom's standard panel-mount package. Manufactured in Crydom's ISO 9001 Certified facility for optimum product performance and reliability.

## OUTPUT SPECIFICATIONS ①

MODEL NUMBERS	D1D07	D1D12	D1D20	D1D40	D2D07	D2D12	D4D07	D4D12	D5D07	D5D10
Operating Voltage Range [Vdc]	0-100	0-100	0-100	0-100	0-200	0-200	0-400	0-400	0-500	0-500
Max. Load Current ③ [A dc]	7	12	20	40	7	12	7	12	7	10
Min. Load Current [mA]	20	20	20	20	20	20	20	20	20	20
Max. Surge Current, [A dc] (10Msec)	15	28	42	106	22	27	17	36	19	29
Max. On-State Voltage Drop @ Rated Current [Vdc]	2.0	1.6	2.1	2.1	2.0	2.8	4.2	4.2	5.7	5.5
Thermal Resistance Junction to Case [R <sub>θJC</sub> ] C/W	2.2	1.34	1.06	0.83	1.5	1.06	1.06	0.8	1.0	0.8
Max On-state Resistance @ Rated Current (R <sub>DS-ON</sub> ) [Ohms]	.29	.13	.10	.05	.29	.23	.6	.35	.8	.55
Max. Off-State Leakage Current @ Rated Voltage [mA]	0.1	0.2	0.3	0.3	0.1	0.3	0.3	0.3	0.2	0.3
Max. Turn-On Time [µsec]	100	100	100	100	100	100	100	100	100	100
Max. Turn-Off Time [msec]	1.0	1.0	1.0	1.0	1.0	1.0	1.0	1.0	1.0	1.0

## INPUT SPECIFICATIONS ①

Control Voltage Range	3.5-32 Vdc
Maximum Turn-On Voltage	3.5 Vdc
Minimum Turn-Off Voltage	1.0 Vdc
Nominal Input Impedance	See Note 4
Maximum Input Current	1.6 mA (5 Vdc), 28 mA (32 Vdc) ④

## DC CONTROL

## GENERAL NOTES

- ① All parameters at 25°C unless otherwise specified.
- ② Dielectric strength and insulation resistance are measured between input and output.
- ③ Heat sinking required, for derating curves see page 3.
- ④ Input circuitry incorporates active current limiter.

©2003 CRYDOM CORP, Specifications subject to change without notice.



## GENERAL SPECIFICATIONS

Dielectric Strength 60Hz	2500 Vrms
Insulation Resistance (Min.) @ 500 Vdc	10 <sup>9</sup> Ohm
Max. Capacitance Input/Output	50 pF
Ambient Operating Temperature Range	-20 to 80°C
Ambient Storage Temperature Range	-20 to 125°C

## MECHANICAL SPECIFICATIONS

Weight: (typical)	3.0 oz. (86.5g)
Encapsulation:	Thermally Conductive Epoxy
Terminals:	Screws and Saddle Clamps Furnished, Unmounted

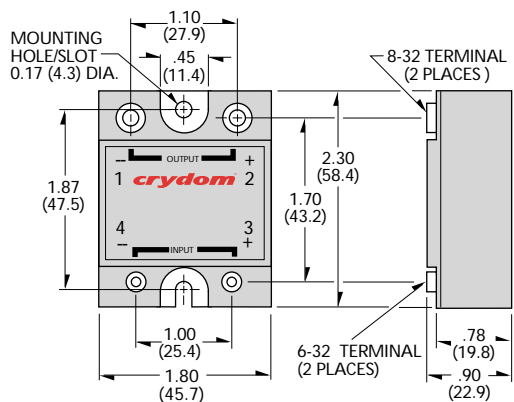

All dimensions are in inches (millimeters)

**Screw Torque Requirements:** 6-32 Screws - 10 in. lbs., 8-32 and 10-32 Screws - 20in. lbs. (Screws dry without grease.)

Input and output polarity must be observed.  
Inductive loads must be diode suppressed.

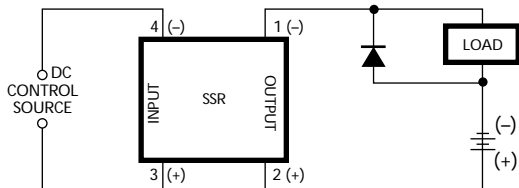

### Transient Protection

All loads are inductive, even ones that are not so labeled. An inductive load will produce harmful transient voltages when it is turned off. The more perfect the switch, the larger the transient voltages; the MOSFET output is so nearly an ideal switch that the transient voltages produced by seemingly "non-inductive" loads can cause damage if not suppressed. Diodes should be fast recovery type with PIV rated greater than supply voltage.

## MAXIMUM SURGE vs. DURATION

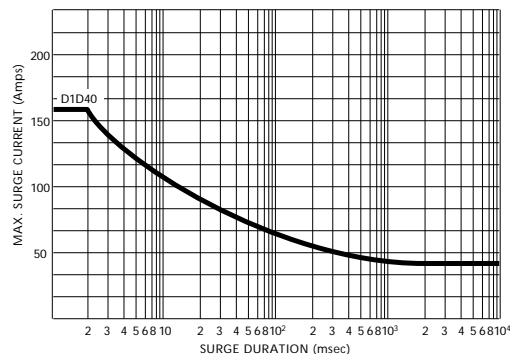
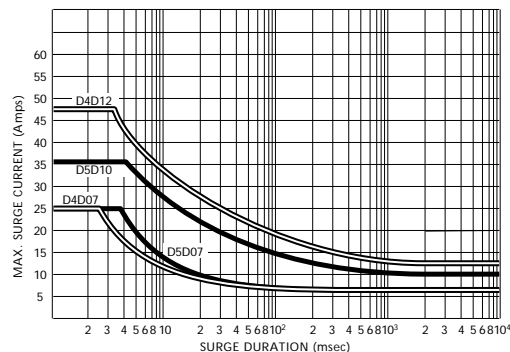
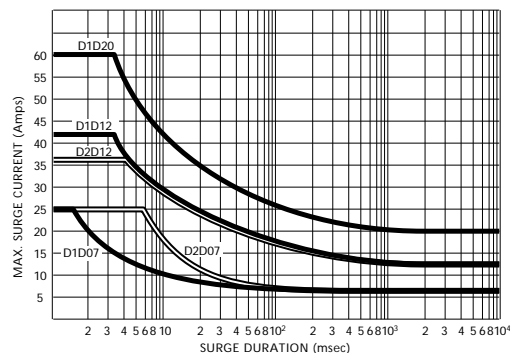

©2003 CRYDOM CORP, Specifications subject to change without notice.

## APPROVALS

UL E116950 (100 Volt Models Only)



FastFax Document No. 164  
SERIES 1DC.  
Rev. 111003  
PAGE 2 OF 3

For recommended applications and more information contact:

**USA: Sales Support** (877) 502-5500 **Tech Support** (877) 702-7700 **FAX** (619) 710-8540  
Crydom Corp, 2320 Paseo de las Americas, Ste. 201, San Diego, CA 92154

**Email:** sales@crydom.com **WEB SITE:** <http://www.crydom.com>

**UK:** +44 (0)1202 365070 • **FAX** +44 (0)1202 365090 Crydom International Ltd., 7 Cobham

Road, Ferndown Industrial Estate, Ferndown, Dorset BH21 7PE, **Email:** intsales@crydom.com.

**GERMANY:** +49 (0)180 3000 506



**Crydom Heat Sinks** offer excellent thermal management and are perfectly matched to the load current ratings of Crydom panel mount relays. Request Crydom's Heat Sink specification sheet for all the details.

## CURRENT DERATING CURVES

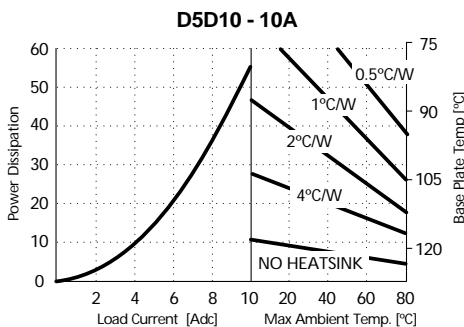
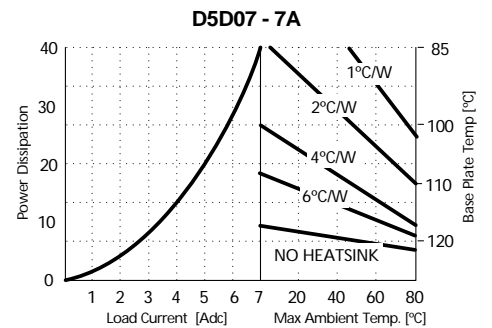
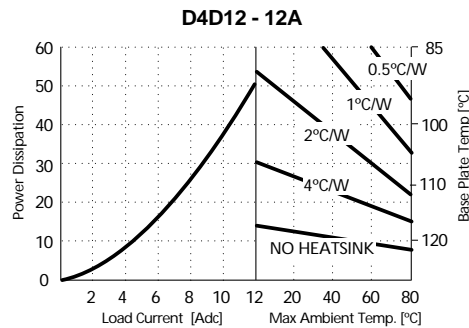
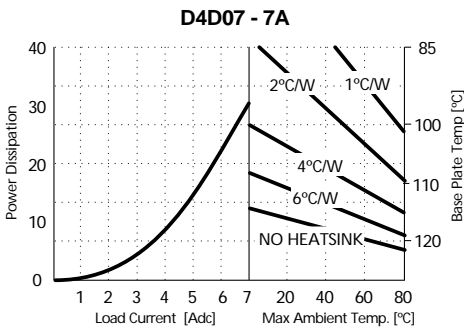
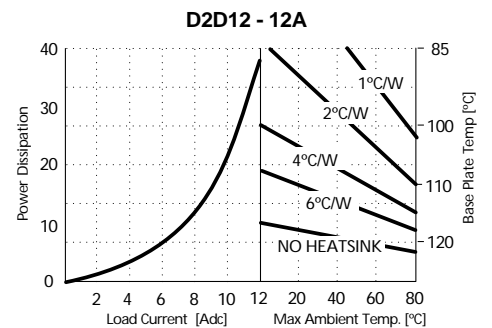
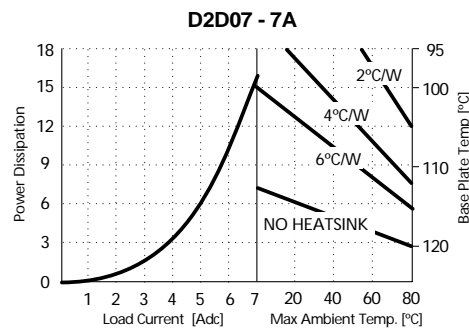
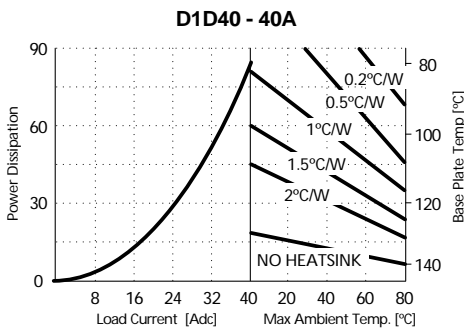
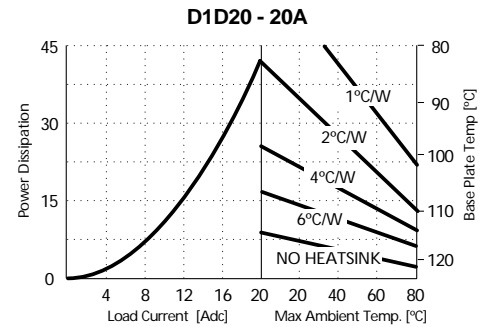
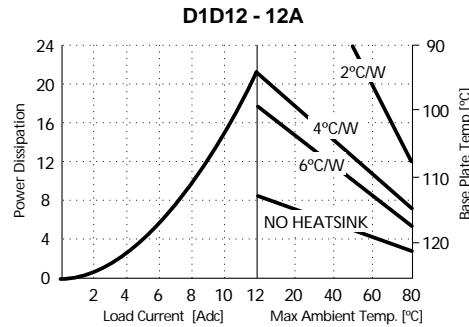
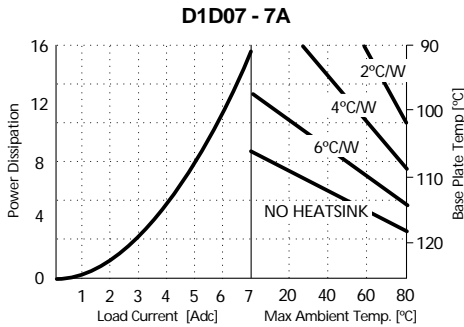

©2003 CRYDOM CORP, Specifications subject to change without notice.

For recommended applications and more information contact:  
**USA: Sales Support** (877) 502-5500 **Tech Support** (877) 702-7700 **FAX** (619) 710-8540  
 Crydom Corp, 2320 Paseo de las Americas, Ste. 201, San Diego, CA 92154  
**Email:** sales@crydom.com **WEB SITE:** http://www.crydom.com  
**UK:** +44 (0)1202 365070 • **FAX** +44 (0)1202 365090 Crydom International Ltd., 7 Cobham  
 Road, Ferndown Industrial Estate, Ferndown, Dorset BH21 7PE, **Email:** intsales@crydom.com.  
**GERMANY:** +49 (0)180 3000 506





## Artisan Technology Group is your source for quality new and certified-used/pre-owned equipment

- FAST SHIPPING AND DELIVERY
- TENS OF THOUSANDS OF IN-STOCK ITEMS
- EQUIPMENT DEMOS
- HUNDREDS OF MANUFACTURERS SUPPORTED
- LEASING/MONTHLY RENTALS
- ITAR CERTIFIED SECURE ASSET SOLUTIONS

### SERVICE CENTER REPAIRS

Experienced engineers and technicians on staff at our full-service, in-house repair center

### *InstraView*<sup>SM</sup> REMOTE INSPECTION

Remotely inspect equipment before purchasing with our interactive website at [www.instraview.com](http://www.instraview.com) ↗

### WE BUY USED EQUIPMENT

Sell your excess, underutilized, and idle used equipment. We also offer credit for buy-backs and trade-ins. [www.artisanng.com/WeBuyEquipment](http://www.artisanng.com/WeBuyEquipment) ↗

### LOOKING FOR MORE INFORMATION?

Visit us on the web at [www.artisanng.com](http://www.artisanng.com) ↗ for more information on price quotations, drivers, technical specifications, manuals, and documentation

**Contact us:** (888) 88-SOURCE | [sales@artisanng.com](mailto:sales@artisanng.com) | [www.artisanng.com](http://www.artisanng.com)