



Artisan Technology Group is your source for quality new and certified-used/pre-owned equipment

- FAST SHIPPING AND DELIVERY
- TENS OF THOUSANDS OF IN-STOCK ITEMS
- EQUIPMENT DEMOS
- HUNDREDS OF MANUFACTURERS SUPPORTED
- LEASING/MONTHLY RENTALS
- ITAR CERTIFIED SECURE ASSET SOLUTIONS

SERVICE CENTER REPAIRS

Experienced engineers and technicians on staff at our full-service, in-house repair center

*InstraView*SM REMOTE INSPECTION

Remotely inspect equipment before purchasing with our interactive website at www.instraview.com ↗

WE BUY USED EQUIPMENT

Sell your excess, underutilized, and idle used equipment. We also offer credit for buy-backs and trade-ins. www.artisanng.com/WeBuyEquipment ↗

LOOKING FOR MORE INFORMATION?

Visit us on the web at www.artisanng.com ↗ for more information on price quotations, drivers, technical specifications, manuals, and documentation

Contact us: (888) 88-SOURCE | sales@artisanng.com | www.artisanng.com

Short Form Catalog

Series of MIL-STD-1553 Products



- Single-Function and Multi-Function Board Lines
- Proven Feature-Rich Microcode
- Bus Controller, Multiple Remote Terminal, and Bus Monitor Modes
- Extensive Software Library/Driver Support
- Application Software is Compatible Across Different Backplanes
- One or Two Redundant 1553 Buses per Board

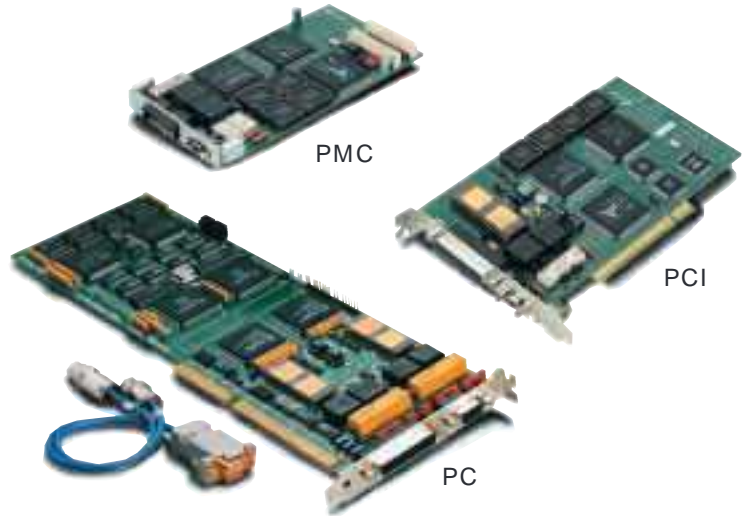

Introduction

Systran's 1553 Solutions lead the industry with the impressive Gold+ Series of MIL-STD-1553 boards. Their microcode-based communication capabilities meet the needs of many applications, including 1553A, 1553B, and mixed-device bus simulations. Single and multi-function boards are available, making it easy to configure the ideal 1553 system for hardware development, software development, and production test applications. With software compatibility across different backplanes, the Gold+ Series boards meet MIL-STD-1553 communication and simulation needs accurately, efficiently, and economically.

The Gold+ Series

The Gold+ Series consists of single and multi-function boards. Single-function boards are used for applications such as monitoring 1553 bus traffic. Multi-function boards can inject errors into 1553 bus traffic and have the ability to perform more than one function at a time. These boards are used for system simulation and test applications that also need electrical and protocol error injection.

All single-function boards use the same subset of microcode and use the same hardware platform as their multi-function counterparts. A powerful Texas Instruments® Digital Signal Processor executes the microcode that performs all 1553A/B functions. An extensive set of bus instructions allows each board to

execute a 1553 bus list with minimal host overhead or intervention. All Gold+ boards can act as a bus controller (BC), can emulate multiple remote terminals (MRTs), and can function as a complete chronological bus monitor (BM).

The Gold Standard

While the MIL-STD-1553 defines a standard for avionics communications, it does not define a standard for how to simulate 1553 systems or subsystems. With 18 years of real-time MIL-STD-1553 simulation design experience, 1553 Solutions engineers have developed flexible microcode which allows these interface boards to successfully simulate a wider range of possible 1553 avionics system configurations.

Bus Controller Mode

Gold+ Series boards have a powerful bus controller with an extensive bus instruction set. To track bus list execution, the user has a choice of methods, including reading the Current Bus Instruction Address Register, checking the buffer transmitted/received bit, or generating an interrupt for any particular bus instruction. Bus instructions include all 1553 commands, Jump to Sublist, Jump on Status Exception, Jump on Protocol Error, Return, Unconditional Jump, Reset Stack, Wait, Delay, Pause, and Halt. An interrupt can be enabled for any instruction, allowing the host CPU to track bus list



status or the execution of specific messages. The bus list can be synchronized to external events via an RS-422 input signal and the Pause command. A discrete output signal can also be enabled to notify another device of the execution of any bus instruction.

Multiple Remote Terminal Emulation Mode

All Gold+ Series boards, both single-function and multi-function, have the ability to emulate up to 32 RTs. This differentiates them from all protocol chip-based 1553 single-function products on the market. Selection of 1553A or B protocol form emulation can be done at the subaddress (SA) level.

Chronological Monitor Mode

In monitor mode, Gold+ Series boards can capture all bus traffic or automatically filter bus traffic by RT, subaddress, and direction which saves memory. While capturing all bus traffic chronologically, interrupts can be enabled for specific events, allowing the host to find certain messages in the chronological buffers quickly.

Maximum Flexibility

Each board in the memory-mapped Gold+ Series provides the optimal interface between a host CPU and one or more 1553 buses. The user can employ either a sophisticated interrupt handling mechanism with interrupt queuing or polling to track board status. The linked data buffer architecture of the Gold+ boards allows maximum flexibility in setting up any BC or multiple RT simulation. Double buffering is one of the many storage mechanisms the boards support.

True Dual Channels

Dual-channel Gold+ Series boards (two A and two B buses) are the equivalent of two boards in one slot. They feature dual processors, independent RAM and I/O for all setup and control functions and buffers.

Gate Array Technology

Gold+ Series multi-function boards use gate arrays. This technology maximizes reliability and minimizes power consumption, especially when compared to discrete TTL-based designs. The reduced part count also creates a simplified layout and design which decreases the board's operating temperature.

Common Software Interface

1553 Solutions boards have a common software interface, saving programming time and associated costs. User software developed on one backplane (for example, a PC used in hardware development) can be easily ported to another backplane (for example, a VXI in production test). This minimizes application and test software development time as a project moves from design to production.

With the Gold+ Series, software configuration management is also optimized for maximum time savings. A single application program can identify either a multi-function or single-function board through a simple interrogation process, eliminating extra application software development.

Applications

Systran's 1553 Solutions can be used in a broad range of MIL-STD-1553 communication and simulation applications, including 1553A/B, and mixed-device bus simulations.

Typical applications include:

- Hardware Development
- Simulation Testing
- Systems Integration
- Production Testing
- Bus Analysis
- Flight Line Testing
- Field Testing

Sample Application

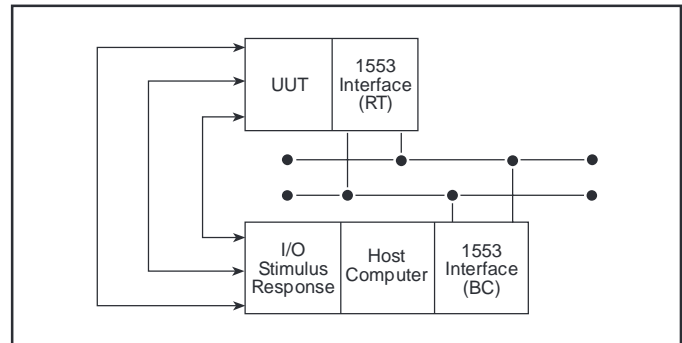

This diagram shows the testing of an RT with a single-function 1553 interface. Our 1553 products, along with LabVIEW™ and LabWindows® libraries, allow test engineers to do complete avionics subsystem testing.

Specifications

Electrical Requirements:

Single Channel	Dual Channel
+5 VDC, 2.4 Amps	+5 VDC, 4.2 Amps
+12 VDC, .19 Amps	+12 VDC, .38 Amps
-12 VDC, .0125 Amps	-12 VDC, .05 Amps

Operating Temperature:

Operating: 0° to 50° C (32° to 122° F)
Storage: -20° to +85° C (-40° to +185° F)

Operating Humidity:

5% to 90% (noncondensing)

1553 Solutions Product Family

Gold+PCI

Hardware Compatibility:

PCI Local Bus Specification, Rev. 2.1
PMC IEEE P1386.1/Draft 2.0

Physical Dimensions:

4.200" x 6.860"
(106.680 mm x 174.244 mm)

Memory:

64 K words (D16) of dual-port RAM

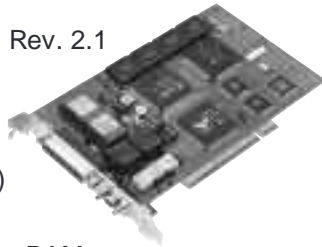

Gold+PMC

Hardware Compatibility:

PCI Local Bus Specification, Rev. 2.1
PMC IEEE P1386.1/Draft 2.0

Physical Dimensions:

2.913" x 5.866"
(74.000 mm x 149.000 mm)

Memory:

64 K words (D16) of dual-port RAM

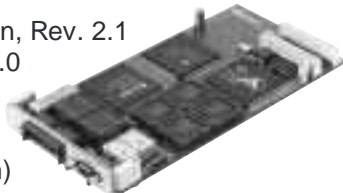

Gold+PC

Hardware Compatibility:

ISA Compliant/
EISA Compatible

Physical Dimensions:

4.400" x 13.100"
(111.760 mm x 332.740 mm)

Memory:

32 K words of dual-port RAM per channel

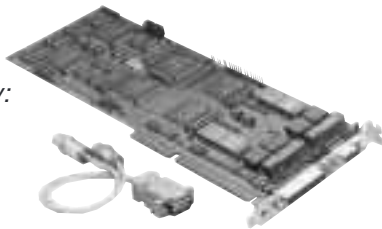

Gold+VME6U

Hardware Compatibility:

VMEbus Rev. D Compliant

Physical Dimensions:

6.299" x 9.173"
(160.000 mm x 233.000 mm)

Memory:

64 K words of dual-port RAM per channel

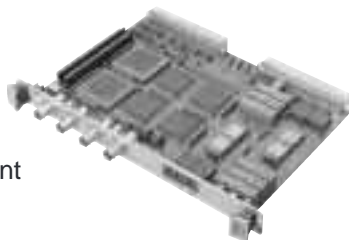

Gold+VXI

Hardware Compatibility:

VXI Plug & Play
Standard 1993
VMEbus Specification
ANSI/IEEE Std.1014-1987,
IEC 821 and 297

Physical Dimensions:

C Size – 9.173" x 13.386"
(233.000 mm x 340.000 mm)

Memory:

64 K words of dual-port RAM

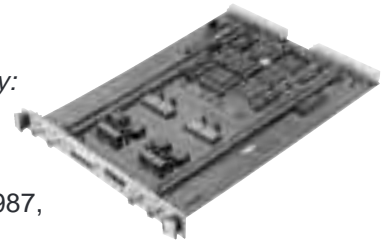

Accessories

Standard 1553 Cable

1553 cable is composed of twinax cable and is used for both bus cabling and stub connections.



1553 Single Channel Cable Assembly

This cable assembly provides the connection to a 1553 bus or stub for our single channel Gold+ Series boards.



1553 Dual Channel Cable Assembly

This cable assembly provides the connection to a 1553 bus or stub for our dual channel Gold+ Series boards.



Bus Coupler

This 1553 Transformer Coupler Box has three-lug Bulkhead Jacks and is used for transformer coupling devices to the 1553 bus.

Terminator Plug

The Terminator plug provides a 78 ohm resistor termination at the end of the 1553 bus.

Tee Connector

Tee Connectors are used for direct coupling devices to the 1553 bus.

Gold+ Series Software Driver Support

Each board in the Gold+ Series is supplied with our standard library/driver software. These routines are developed in C and are provided as source code.

Many boards are also supplied with our new SIMMPL library/driver software. SIMMPL libraries provide a very intuitive user interface that reduces configuration and startup time by handling all register accesses and memory management at the library level. The software determines the board's valid channels and configures them automatically. Once configuration is complete, all data structures are initialized with default values. By using default values that can be modified by the library, it is no longer necessary to pass some parameters to the software routines.

SIMMPL software libraries also include a "point & click" graphical Hardware Confidence Test (HCT). This all-new HCT allows you to verify memory, registers, interrupts, and 1553 data transfer integrity. It also provides direct access to the registers and memory.

The latest, most popular operating systems (such as Windows 95 and NT) and programming environments (such as LabVIEW and LabWindows/CVI) are supported. Check the table below for the operating systems and programming environments supported by specific board type.



PC	PMC	VME
GoldExpress	VxWorks®	Motorola® UNIX®
LabVIEW 4.0 (Win 3.1)	LabWindows 4.0 (Win NT)	SIMMPL (VxWorks)
LabVIEW 5.0 (Win 95/NT)	LabVIEW 5.0 (Win NT)	VxWorks
LabWindows/CVI 4.0 (Win 3.1/95/NT)	SIMMPL (Win NT)	VXI
MS-DOS®	PCI	LabVIEW 4.0 (Win 3.1/95/NT)
SIMMPL (Win 95/NT)	GoldExpress	LabWindows/CVI 4.0 (Win 3.1/95/NT)
Windows 3.1	SIMMPL (Win NT)	Motorola Unix
Windows 95	LabWindows 4.0 (Win NT)	Windows 3.1
Windows NT®	LabVIEW 5.0 (Win NT)	Windows 95
		Windows NT

GoldExpress Software

GoldExpress is the latest graphical interface for MIL-STD-1553 bus analysis. It is easy to use for general purpose data acquisition, mission loading, LRU testing, and data bus debugging.

GoldExpress uses a common top level menu that accesses overlay modules which are board and/or interface specific. GoldExpress is self configuring depending upon the hardware interfaces that are installed. The menu structure allows the user to independently define data to be captured or displayed, as

well as the option to display the data in easy to understand engineering units.

GoldExpress can work with two dual channel cards, one dual channel and two single channel cards, or four single channel cards. It automatically recognizes the hardware that is present in the system and once configured, the setup information can be stored to disk. Different setups can be stored for each application using any combination of Systran's Gold-PC, Gold+PC, and Gold+PC/S.

Filter and find options are available for post processing data as well as the ability to mark events for ease of location. Standard types of data fields such as BCD, Unsigned, 2's Complement, IEEE488 Real, Conditional Match, etc. are selectable, or the user can define data fields independently. Each defined data field has unique names, values, and units defined by the user.

The menu structure allows the user to access all three modes of the 1553 card: bus controller, multiple remote terminal emulation, and bus monitor. Using GoldExpress in any of the three modes is easy. Previously stored setups can be loaded for quick operation. An Activity screen allows the user to quickly see which RTs and subaddresses are active.

GoldExpress runs under Windows® 3.1 and Windows 95 (16 bit). Call Systran sales at 800-252-5601 (U.S. only) for a free demonstration disk.



PCMCIA Card

Introduction

Systran's 1553 Solutions PCMCIA card is specifically designed for MIL-STD-1553A/B communication applications. The inclusion of both bus controller and remote terminal capability gives the 1553 Solutions PCMCIA card excellent utility as a memory loader/verifier. Coupled with Systran's MS-DOS and Windows DLLs, the card is easily integrated into application software for fast, efficient downloading and uploading of commands and data.

Applications

The "plug and play" versatility of the PCMCIA card makes it the ideal interface for a variety of MIL-STD-1553 applications. For example:

Mission Planning: With its dual 128 KB banks of memory, the 1553 Solutions PCMCIA card enables maximum downloading of mission planning data during application setup. Because it is a Type II PC card, it allows room in most portable PCs for the installation of a second Type II card.

Lab Simulation: The 1553 Solutions PCMCIA card is well suited for many types of lab simulation applications. The same PCMCIA card used in the lab for prototype development can be used in a portable computing system for on-site field testing during later phases of a program. This capability saves software development costs and leverages the user's 1553 hardware investment.

Data Acquisition: In addition to the bus controller and remote terminal modes, each 1553 Solutions PCMCIA card includes a bus monitor mode that enables the card to operate equally well on both 1553A/B systems. Using the standard card and socket services software and our optional Windows software, your PC becomes an inexpensive, easy-to-use 1553 data acquisition system.

CardExpress Software

CardExpress is an extremely easy-to-use program for users who just want to run a simple buslist in bus controller mode, emulate a single remote terminal in remote terminal mode, or simply capture some bus data in bus monitor mode. For applications like these, it is a great, low-cost alternative to a full bus analyzer software package. CardExpress displays 1553 bus traffic for post run analysis and supports one 1553 module.

CardExpress runs under Windows 3.1 and Windows 95/NT. Call Systran sales at 800-252-5601 (U.S. only) for a free demonstration disk.



Software Driver Support

CardExpress	Windows 3.1
MS-DOS	Windows 95
	Windows NT ¹

¹ Requires CardWare PC card software available from Award Software International Inc.

Specifications

Hardware Compatability:	PCMCIA (2.1) Type II
Electrical Requirements:	+5 VDC, 200 mA (power-on, with bus traffic) +5 VDC, 125 mA (power-on, no bus traffic) +5 VDC, 85 mA (power-down)
Operating Temperature:	0° to 50° C (32° to 122° F)
Memory:	256 KB divided into two logical 128 KB blocks





Multiplex 1553 Bus Switch

- Connects Multiple MIL-STD-1553 Resources Across Local and Extended Buses
- Simultaneously Runs Multiple Switch Configurations Through Easy-to-Use Graphical Software
- Eliminates Time-Consuming Bus Rewiring

The BusXchange Multiplex 1553 Bus Switch complements our 1553 Solutions and other vendors' MIL-STD-1553 products by providing a virtual patch panel in a 19" rack-mountable chassis. This 16x16 crosspoint switch provides differential connections from 16 transformer-coupled Line Replaceable Unit (LRU) inputs to 16 MIL-STD-1553 differential buses. The LRUs can be any transformer-coupled MIL-STD-1553 device: bus controller, remote terminal, or bus monitor.

Although the switch supports 16 non-redundant LRUs, it can also be used with dual (or more) redundant devices. BusXchange virtually eliminates time-consuming bus rewiring between avionics simulations or test scenarios.

The BusXchange switch provides 16 LRU inputs via standard concentric twinax connectors on the front of the unit. The 16 bus output connections, which utilize the same type of connectors, are available on the rear of the unit. Multiple switches may also be connected together for more LRU inputs or bus connections.

The BusXchange switch configuration is controlled via an internal processor and associated RS-232 serial port. The operator control and status information is sent via the serial port to a control terminal or computer. LRU inputs may be selectively connected (or disconnected) from a specified bus. The internal controller ensures that each LRU is not simultaneously connected to more than one bus.

The serial port provides switch status when commanded, allowing a user to view the current switch configuration. The switch also includes a front-panel display that indicates current switch state, which is useful if the operator control device is not located close to the unit.

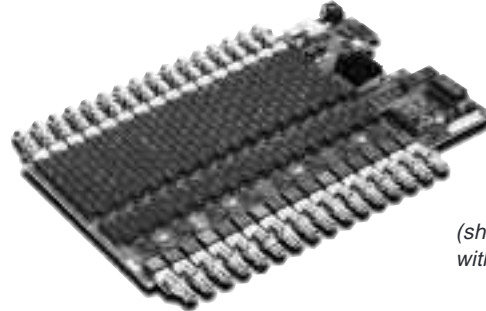

(shown with and without enclosure)

The BusXchange switch command set is thoroughly documented in the users' guide, allowing users to maintain control through a dumb terminal or to write separate communication software. A Windows NT®-based configuration utility is available that enables the user to control the BusXchange switch from a desktop PC without knowledge of the switch's command set.

Specifications

Hardware Compatibility:
MIL-STD-1553A/B

Physical Dimensions:
10.275" x 17.000" x 1.720"
(260.985 mm x 431.800 mm x 43.688 mm)

*Includes enclosure with standard side panels

Electrical Requirements:
+5 VDC, 3.5 Amps

Operating Temperature:
0° to 50° C (32° to 122° F)

Storage Temperature:
-25° to 70° C (-13° to 158° F)

Humidity:
5% to 95% (noncondensing)

The BusXchange Multiplex 1553 Bus Switch was developed in cooperation with Science Applications International Corporation and the United States Air Force Research Lab, Embedded Information Systems Engineering Branch (AFRL/IFTA).

Resource Allocation Manager™

- Transforms Switch Hardware into a Remote Control Patch Panel
- Provides Full Configuration Storage, Scheduling, and Remote Switching Capability
- Increases Resource Utilization Across Your Entire Enterprise
- Scalable from a Single User and Resource to Hundreds of Users and Switches

Resource Allocation Manager, a GUI software application provided with each BusXchange 1553 Multiplex Bus Switch, offers unparalleled flexibility for creating custom, high-performance MIL-STD-1553 databus configurations.

With Resource Allocation Manager, one or more BusXchange Switches are transformed into a highly efficient electronic patch panel that lets you control all aspects of the network simply by using software to issue commands, define values, and select options. This digital control eliminates the broken wires, loose connectors, and human error of manual patch panel systems, delivering outstanding network configuration efficiency.

Use Resource Allocation Manager to:

- Switch equipment in/out of a network configuration in a system



Provides advanced scheduling of test configurations and prevents resource conflicts

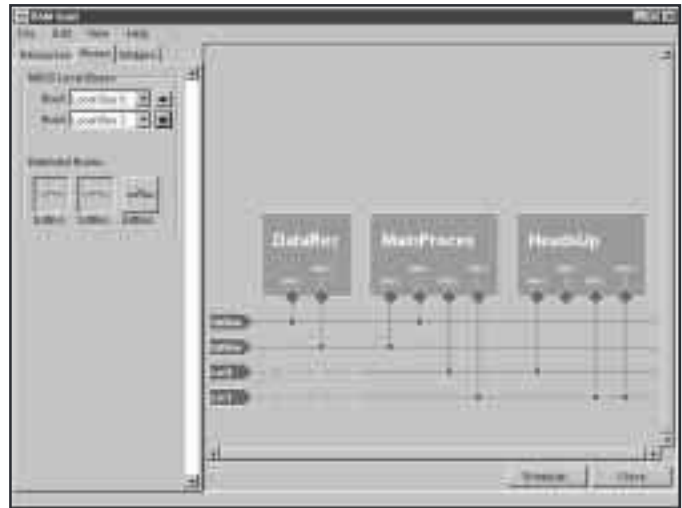

- Connect equipment in separate systems (or even in separate labs) for integration testing
- Move a bus monitor around to different buses

Running under the Microsoft Windows NT operating system, Resource Allocation Manager provides a comprehensive set of menus to enable you to fully control network setup and configuration:

- Bus Setup
- Switch and switch attachment setup
- Resource and resource attachment setup
- Bus selection and configuration

Through a graphical user interface, you define a set of resources, establish how they are to be connected, and schedule the date, time and duration that they are to remain connected. The Resource Allocation Manager software then uses the configuration to generate commands for the switching hardware to make the necessary signal connections.

All network connections are made quickly and accurately. Their graphical representation makes them easy to identify, enabling you to get even the most complex networks up-and-running faster than ever. What's more, the ability to save and retrieve multiple configurations provides instant, on-demand access to the many previously defined simulation and test scenarios.

With Resource Allocation Manager, you drastically improve your resource utilization by reducing the number of standalone systems required for your test scenario and eliminating resource redundancy, which results in overall lower acquisition and maintenance costs.



Artisan Technology Group is your source for quality new and certified-used/pre-owned equipment

- FAST SHIPPING AND DELIVERY
- TENS OF THOUSANDS OF IN-STOCK ITEMS
- EQUIPMENT DEMOS
- HUNDREDS OF MANUFACTURERS SUPPORTED
- LEASING/MONTHLY RENTALS
- ITAR CERTIFIED SECURE ASSET SOLUTIONS

SERVICE CENTER REPAIRS

Experienced engineers and technicians on staff at our full-service, in-house repair center

*InstraView*SM REMOTE INSPECTION

Remotely inspect equipment before purchasing with our interactive website at www.instraview.com ↗

WE BUY USED EQUIPMENT

Sell your excess, underutilized, and idle used equipment. We also offer credit for buy-backs and trade-ins. www.artisanng.com/WeBuyEquipment ↗

LOOKING FOR MORE INFORMATION?

Visit us on the web at www.artisanng.com ↗ for more information on price quotations, drivers, technical specifications, manuals, and documentation

Contact us: (888) 88-SOURCE | sales@artisanng.com | www.artisanng.com