



## Artisan Technology Group is your source for quality new and certified-used/pre-owned equipment

- FAST SHIPPING AND DELIVERY
- TENS OF THOUSANDS OF IN-STOCK ITEMS
- EQUIPMENT DEMOS
- HUNDREDS OF MANUFACTURERS SUPPORTED
- LEASING/MONTHLY RENTALS
- ITAR CERTIFIED SECURE ASSET SOLUTIONS

### SERVICE CENTER REPAIRS

Experienced engineers and technicians on staff at our full-service, in-house repair center

### *InstraView*<sup>SM</sup> REMOTE INSPECTION

Remotely inspect equipment before purchasing with our interactive website at [www.instraview.com](http://www.instraview.com) ↗

### WE BUY USED EQUIPMENT

Sell your excess, underutilized, and idle used equipment. We also offer credit for buy-backs and trade-ins. [www.artisanng.com/WeBuyEquipment](http://www.artisanng.com/WeBuyEquipment) ↗

### LOOKING FOR MORE INFORMATION?

Visit us on the web at [www.artisanng.com](http://www.artisanng.com) ↗ for more information on price quotations, drivers, technical specifications, manuals, and documentation

**Contact us:** (888) 88-SOURCE | [sales@artisanng.com](mailto:sales@artisanng.com) | [www.artisanng.com](http://www.artisanng.com)



6400 Flying Cloud Drive  
Eden Prairie, MN 55344  
(612) 943-9020

DigiBoard GmbH  
Domkloster 1  
50667 Köln  
Germany  
+49 221 920520

# Installation Guide

**DigiBoard PC/X and MC/X  
Non-Intelligent Asynchronous  
Serial Communications Boards**

90029700A

**DigiBoard®** is a registered trademark of Digi International Inc. **DigiWARE™**, **PC/X™**, **MC/X™**, **PC/16™**, **PC/8™**, **PC/4™**, **MC/16™**, **MC/8™** and **MC/4™** are trademarks of Digi International Inc. All other brand and product names are the trademarks of their respective holders.

© Digi International Inc. 1994  
All Rights Reserved

**Digi International Inc.,  
d. b. a. DigiBoard**

6400 Flying Cloud Drive  
Eden Prairie, MN 55344

Phone (612) 943-9020  
FAX (612) 943-5398  
BBS (612) 943-0812

**DigiBoard GmbH**

Domkloster 1  
50667 Köln  
Germany

Phone +49 221 920520  
FAX +49 221 9205210  
BBS +49 221 9205211

Information in this document is subject to change without notice and does not represent a commitment on the part of DigiBoard.

DigiBoard provides this document “as is,” without warranty of any kind, either expressed or implied, including, but not limited to, the particular purpose. DigiBoard may make improvements and/or changes in this manual or in the product(s) and/or the program(s) described in this manual at any time.

This product could include technical inaccuracies or typographical errors. Changes are periodically made to the information herein; these changes may be incorporated in new editions of the publication.

# Table of Contents

Certification Information.....	vii
The DigiBoard Bulletin Board System.....	viii
Internet FTP Server .....	viii
FaxBack Server.....	viii
Technical Support.....	ix
Customer Service.....	ix
Device Driver Support.....	xi
Return Procedures.....	xii
Introduction .....	1
Components.....	1
Installation .....	2
PC/4 and PC/8 Boards.....	3
Before you plug in the board. . . . .	3
Setting the I/O Port Addresses.....	4
Setting the Interrupt Status Register Address .....	9
Setting the IRQ .....	10
Board Identification .....	12
Daisy Chain Connectors P2 and P3 .....	13
Plugging in the Board.....	14
PC/16 Boards.....	15
Before you plug in the board. . . . .	15
I/O Port Addresses .....	15
IRQ Selection.....	18
Board Identification .....	19
Daisy Chain Connector P3.....	20
Plugging in the Board.....	21
MC/X Boards .....	22
Before you plug in the board. . . . .	22
Plugging in the Board.....	24
Configuring the Board.....	25
Connecting Peripherals.....	29
Terminals and Printers .....	29
Software Handshaking (XON/XOFF) .....	29
Hardware Handshaking (Ready/Busy) .....	31
Modems.....	32
ALTPIN Modem Wiring (RJ-45 Versions) .....	33

RS-232 Cables and Connector Options .....	34
Cables .....	34
Grounding .....	34
Environment .....	34
Capacitance vs. Length of Run .....	34
Connector Options .....	35
DB-25 Connectors .....	35
DB-25 Connector Options .....	36
Quad and Octa Cable Option (DTE or DCE) .....	36
Quad and Octa Connector Boxes (DTE or DCE) .....	37
DB-9 Connectors .....	38
RJ-45 Connectors .....	39
Modular Plugs .....	40
RJ-45 to DB-25 Conversion .....	41
Daisy Chaining PC/X Boards .....	43
PC/4 and PC/8 Boards .....	43
PC/16 Boards .....	47
Daisy Chain Cables .....	48
Using PC/X and MC/X Boards with MS-DOS Applications .....	49
PC/X Boards .....	49
MC/X Boards .....	52
Programming Information .....	53
Enabling Interrupts .....	53
Using the Interrupt Status Register .....	54
PC/4 and PC/8 .....	54
PC/16 .....	55
MC/X .....	56
Specifications .....	57
Index .....	63

## List of Figures

Figure 1	PC/8 Board Layout .....	3
Figure 2	Breakdown of DIP Switches DS2-DS9 .....	4
Figure 3	Breakdown of DIP Switch DS1 .....	9
Figure 4	Board ID Jumper Settings for PC/4 and PC/8 Boards .....	12
Figure 5	Connectors P2 and P3 (Single Board Configuration) .....	13
Figure 6	PC/16 Board Layout .....	15
Figure 7	PC/16 Board ID Jumper Settings .....	19
Figure 8	PC/16 Daisy Chain Connector P3, with Jumper .....	20
Figure 9	Folding the Interface Cables .....	21
Figure 10	MC/4 and MC/8 Board Layout .....	23
Figure 11	MC/16 Board Layout .....	23
Figure 12	Simple Terminal/Printer Cable (DB-25) .....	30
Figure 13	Simple Terminal/Printer Cable (RJ-45) .....	30
Figure 14	Terminal/Printer Cable with DTR Handshaking (DB-25) .....	31
Figure 15	Terminal/Printer Cable with DTR Handshaking (RJ-45) .....	31
Figure 16	Modem Cable .....	32
Figure 17	Full 10-Wire Modem Cable (RJ-45) .....	32
Figure 18	8-Wire Modem Cable for use with ALTPIN Configuration .....	33
Figure 19	Octa Cable Assembly .....	36
Figure 20	Eight-Port DB-25 Connector Box .....	37
Figure 21	Eight-Port RJ-45 Connector Box .....	39
Figure 22	RJ-45 to DB-25 “Cable Leg” .....	41
Figure 23	Single Board System (PC/4, PC/8) .....	44
Figure 24	Two Board System (PC/4, PC/8) .....	44
Figure 25	Three Board System (PC/4, PC/8) .....	45
Figure 26	Four Board System (PC/4, PC/8) .....	46
Figure 27	One Board System (PC/16) .....	47
Figure 28	Two Board System (PC/16) .....	47

## List of Tables

Table 1	DIP Switch Settings for I/O Port Addresses .....	5
Table 2	IRQ Selection for PC/4 and PC/8 Boards .....	11
Table 3	Standard (DOS) PALs and their Associated I/O Addresses .....	16
Table 4	Pick PALs and their Associated I/O Addresses .....	17
Table 5	PC/16 IRQ Jumper Settings .....	18
Table 6	DB-25 Connector Pin Assignments .....	35
Table 7	DB-25 Cable Options and Part Numbers .....	36
Table 8	Connector Box Options and Part Numbers .....	37
Table 9	DB-9 Connector Pin Assignments .....	38
Table 10	DB-9 Quad and Octa Cable Options and Part Numbers .....	38
Table 11	RJ-45 Connector Box Options .....	39
Table 12	Cable Leg Options and Part Numbers .....	41

# Certification Information

## Radio Frequency Interference (RFI)

(FCC 15.105)

This equipment has been tested and found to comply with the limits for Class B digital devices pursuant to Part 15 of the FCC Rules. These limits are designed to provide reasonable protection against harmful interference in a residential environment. This equipment generates, uses, and can radiate radio frequency energy, and if not installed and used in accordance with the instruction manual, may cause harmful interference to radio communications. However, there is no guarantee that interference will not occur in a particular installation. If this equipment does cause harmful interference to radio or television reception, which can be determined by turning the equipment off and on, the user is encouraged to try and correct the interference by one or more of the following measures:

- Reorient or relocate the receiving antenna.
- Increase the separation between the equipment and the receiver.
- Connect the equipment into an outlet on a circuit different from that to which the receiver is connected.
- Consult the dealer or an experienced radio/TV technician for help.

## Labeling Requirements

(FCC 15.19)

This device complies with Part 15 of FCC rules. Operation is subject to the following two conditions: (1) this device may not cause harmful interference, and (2) this device must accept any interference received, including interference that may cause undesired operation.

## Modifications

(FCC 15.21)

Changes or modifications to this equipment not expressly approved by DigiBoard may void the user's authority to operate this equipment.

## Cables

(FCC 15.27)

Shielded cables *must* be used to remain within the Class B limitations.

## Canadian DOC Notice

This digital apparatus does not exceed the Class B limits for radio noise for digital apparatus set out in the Radio Interference Regulations of the Canadian Department of Communications.



# The DigiBoard Bulletin Board System

DigiBoard provides an electronic bulletin board service (BBS) for our customers. This bulletin board provides general and technical information about DigiBoard's products.

The DigiBoard BBS allows users to download software drivers as soon as they become available. There is also a feature to allow users with problems or questions about DigiBoard products to leave messages to DigiBoard Technical Support.

Using the DigiBoard BBS is easy. Simply dial **(612) 943-0812** or **(612) 943-0549**. The bulletin board accepts calls at 1200, 2400, 9600 and 14.4K baud. V.32, HST 14.4, V.42 and V.42*bis* standards are supported, with full MNP class 1-5 error correction and data compression.

The recommended modem communications parameters are 8 bits, no parity and one stop bit (**8 N 1**). Other settings may also work.

Download protocols include Zmodem, Xmodem, Ymodem, Kermit and others.

## Internet FTP Server

DigiBoard has also set up an Anonymous FTP server for those with access to the Internet network. The address is **ftp.digibd.com (192.83.159.193)**. Log in as **anonymous**, and enter your E-mail address when asked for a password. Drivers and installation tips are located in the **/drivers** directory. A text file, **download.doc**, gives information on uncompressing the files after downloading. Tip: Be sure to enter "**bin**" before downloading, to ensure binary transfer of files.

## FaxBack Server

Manuals and technical information can also be obtained by FAX. To use the FaxBack server, simply call (612) 943-0573 on a touch tone phone.

# Technical Support

At DigiBoard, we are proud of our products, and support them. Our dealers and distributors are fully trained on our product line, so that they can help you on a technical level should assistance be needed.

Your first level of support is your DigiBoard dealer, the place where you purchased your PC/X or MC/X board. Your dealer has the training to help you with any installation questions or difficulties you might have.

If you still experience difficulties (after contacting your first level of support), DigiBoard has a staff of Technical Support Specialists that can assist you. They can be reached at **(612) 943-0578**. In Europe, call **+49 221 920520**. FAX numbers are: (612) 943-0579 (USA) and +49 221 9205210 (Europe).

When you call DigiBoard Technical Support, please call from a position where you can operate your system. Also, please fill out the form on the opposite page before calling, so your Technical Support representative can have a clear picture of your system and any potential conflicts between devices.

DigiBoard Technical Support can also be reached via Internet E-mail. Please send correspondences to **support@digibd.com**, and include your voice and FAX phone numbers.

## **Important!**

Before calling Tech Support, be sure to run the user diagnostics, **UD-STD.EXE**, in the **\DIAGS** directory of the Windows, OS/2 and FOSSIL driver diskette (provided with the board). Refer to **USER-STD.TXT** and the help screens in the **UD-STD.EXE** for instructions.

# Customer Service

DigiBoard also has a staff of Customer Service representatives to help you with software and documentation update requests, as well as Returned Merchandise Authorizations (RMAs) in case you need to return your board to DigiBoard for repair (see page *xii*). They can be reached at **(612) 943-0577**.

DigiBoard Customer Service can also be reached via Internet E-mail. Please send correspondences to **cust\_serv@digibd.com**, and include your voice and FAX phone numbers.

## Technical Support Information

Please assist your Technical Support representative by filling in the following information.

Serial number of your PC/X or MC/X board: \_\_\_\_\_ PAL #s (PC/16) U46: \_\_\_\_\_ U58: \_\_\_\_\_

Make, model and clock speed of your computer: \_\_\_\_\_

How much RAM does your computer have? \_\_\_\_\_ MB

Hard disk controller: Type: \_\_\_\_\_ Memory addressed at: \_\_\_\_\_ I/O port used: \_\_\_\_\_ IRQ: \_\_\_\_\_

LAN card: Type: \_\_\_\_\_ Memory addressed at: \_\_\_\_\_ I/O port used: \_\_\_\_\_ IRQ: \_\_\_\_\_

Other: Type: \_\_\_\_\_ Memory addressed at: \_\_\_\_\_ I/O port used: \_\_\_\_\_ IRQ: \_\_\_\_\_

Operating system: \_\_\_\_\_ Version: \_\_\_\_\_

DigiBoard device driver version: \_\_\_\_\_

# Device Driver Support

This product is shipped with device drivers for some of the most commonly used operating systems. Other device drivers may be available, however, and may be obtained, free of charge, from DigiBoard. For information on availability, and to order additional drivers, please contact DigiBoard Customer Service or dial in to the DigiBoard BBS.

## Return Procedures

All DigiBoard products have a five-year parts and labor warranty, and we are ultimately responsible for any defective parts, according to the limits specified in the warranty. However, many of the reported problems are due to factors other than defects in the product itself. To save you time and possibly additional cost, DigiBoard asks that you *first* try to resolve any difficulties by contacting our Technical Support representatives at **(612) 943-0578**.

### **Important!**

*Be sure to have the serial number of your board at hand before calling Technical Support.*

Returns should be directed to the dealer or distributor from whom you purchased the product. If you need to return your PC/X or MC/X board to DigiBoard for repair, it is first necessary to obtain an RMA (Returned Merchandise Authorization) number from DigiBoard, by speaking to a DigiBoard Customer Service representative. Authorized returns should be shipped to DigiBoard, 10000 West 76th Street, Eden Prairie, MN 55344. The RMA number should appear on the shipping carton, on or near the address label.

### **Note:**

*Products received without an RMA number clearly marked on the outside of the package will be returned, unopened, to the sender*

# Introduction

---

This Installation Guide covers the installation and configuration of the DigiBoard PC/X and MC/X asynchronous serial communications boards for ISA and Micro Channel personal computers (“ISA” stands for Industry Standard Architecture, and includes IBM AT and compatible computers, and 80386/80486/Pentium based computers that employ the ISA bus.; Micro Channel computers include most PS/2 computers).

In addition to the board itself (hardware), you may also need to install device driver software for your operating system, so that programs can communicate with the board. Device driver installation instructions are in separate manuals, included with the software diskette(s).

## Components

The carton in which your PC/X or MC/X board was shipped should contain the following items:

- PC/X or MC/X board
- *Installation Guide* (this book)
- One or more software packets containing device driver diskettes and manuals

# Installation

---

**Important!** PC/X and MC/X boards contain static-sensitive components. Always touch a grounded surface to discharge static electricity before handling the circuit board.

The procedures for installing the boards in the PC/X and MC/X families begin on the pages listed below:

PC/4 and PC/8 .....3  
PC/16 ..... 15  
MC/4, MC/8 and MC/16 .....22

## PC/4 and PC/8 Boards

This section provides instructions for installing and configuring PC/4 and PC/8 boards in ISA computers. These include IBM AT and compatible computers, and 80386/80486/Pentium based computers that employ the ISA (Industry Standard Architecture) bus.

Instructions for installing PC/16 boards begin on page 15.

Instructions for installing MC/4 and MC/8 boards (in Micro Channel computers) begin on page 22.

### Before you plug in the board. . .

**Write down the serial number of the board in the form on page x. You will need it if you have to contact DigiBoard regarding the product.**

**Figure 1** **PC/8 Board Layout**

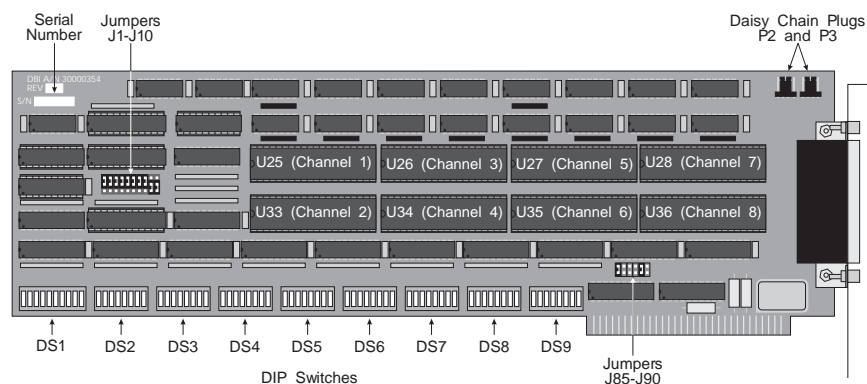

There are a number of DIP switches and jumpers which must be set prior to installing the board in your computer. The DIP switches are used to set the I/O port addresses of the individual asynchronous serial channels and the Interrupt Status Register address. The jumpers are used to select the IRQ (Interrupt Request) line(s) and the board ID number. Consult your software manual for the recommended settings for these parameters.



### *Setting the I/O Port Addresses*

Each port on the PC/X board has its own unique I/O port address, which points to the first of eight I/O registers which are used by that port. DIP switches DS2-DS9 determine the I/O address of ports 1 through 8, respectively (on PC/4 boards, DS6-DS9 are absent).

Each port can be set to any hexadecimal address from 000h to 3F8h (PC/X I/O addresses must always end with 0 or 8). The breakdown of the DIP switches is shown in Figure 2, below.

**Figure 2** **Breakdown of DIP Switches DS2-DS9**

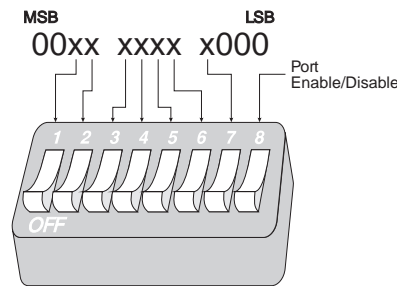

The switches form a binary representation of the I/O address; note that the two most significant bits (MSB) and the three least significant bits (LSB) are always 0. Thus, switches 1 and 2 set the first hex digit of the address to 0-3, switches 3 through 6 set the second digit to 0-F, and switch 7 sets the third digit to 0 or 8.

Switch 8 enables (ON) or disables (OFF) the port.

Table 1, on the following pages, gives the DIP switch settings for all possible addresses from 000h to 3F8h.

**Table 1 DIP Switch Settings for I/O Port Addresses**

I/O	SW-1	SW-2	SW-3	SW-4	SW-5	SW-6	SW-7	SW-8
000h	ON	ON	ON	ON	ON	ON	ON	ON
008h	ON	ON	ON	ON	ON	ON	OFF	ON
010h	ON	ON	ON	ON	ON	OFF	ON	ON
018h	ON	ON	ON	ON	ON	OFF	OFF	ON
020h	ON	ON	ON	ON	OFF	ON	ON	ON
028h	ON	ON	ON	ON	OFF	ON	OFF	ON
030h	ON	ON	ON	ON	OFF	OFF	ON	ON
038h	ON	ON	ON	ON	OFF	OFF	OFF	ON
040h	ON	ON	ON	OFF	ON	ON	ON	ON
048h	ON	ON	ON	OFF	ON	ON	OFF	ON
050h	ON	ON	ON	OFF	ON	OFF	ON	ON
058h	ON	ON	ON	OFF	ON	OFF	OFF	ON
060h	ON	ON	ON	OFF	OFF	ON	ON	ON
068h	ON	ON	ON	OFF	OFF	ON	OFF	ON
070h	ON	ON	ON	OFF	OFF	OFF	ON	ON
078h	ON	ON	ON	OFF	OFF	OFF	OFF	ON
080h	ON	ON	OFF	ON	ON	ON	ON	ON
088h	ON	ON	OFF	ON	ON	ON	OFF	ON
090h	ON	ON	OFF	ON	ON	OFF	ON	ON
098h	ON	ON	OFF	ON	ON	OFF	OFF	ON
0A0h	ON	ON	OFF	ON	OFF	ON	ON	ON
0A8h	ON	ON	OFF	ON	OFF	ON	OFF	ON
0B0h	ON	ON	OFF	ON	OFF	OFF	ON	ON
0B8h	ON	ON	OFF	ON	OFF	OFF	OFF	ON
0C0h	ON	ON	OFF	OFF	ON	ON	ON	ON
0C8h	ON	ON	OFF	OFF	ON	ON	OFF	ON
0D0h	ON	ON	OFF	OFF	ON	OFF	ON	ON
0D8h	ON	ON	OFF	OFF	ON	OFF	OFF	ON
0E0h	ON	ON	OFF	OFF	OFF	ON	ON	ON
0E8h	ON	ON	OFF	OFF	OFF	ON	OFF	ON
0F0h	ON	ON	OFF	OFF	OFF	OFF	ON	ON
0F8h	ON	ON	OFF	OFF	OFF	OFF	OFF	ON

Note: Addresses below 100h are not recommended—these addresses may be reserved by your system. See following pages for more addresses.

I/O	SW-1	SW-2	SW-3	SW-4	SW-5	SW-6	SW-7	SW-8
100h	ON	OFF	ON	ON	ON	ON	ON	ON
108h	ON	OFF	ON	ON	ON	ON	OFF	ON
110h	ON	OFF	ON	ON	ON	OFF	ON	ON
118h	ON	OFF	ON	ON	ON	OFF	OFF	ON
120h	ON	OFF	ON	ON	OFF	ON	ON	ON
128h	ON	OFF	ON	ON	OFF	ON	OFF	ON
130h	ON	OFF	ON	ON	OFF	OFF	ON	ON
138h	ON	OFF	ON	ON	OFF	OFF	OFF	ON
140h	ON	OFF	ON	OFF	ON	ON	ON	ON
148h	ON	OFF	ON	OFF	ON	ON	OFF	ON
150h	ON	OFF	ON	OFF	ON	OFF	ON	ON
158h	ON	OFF	ON	OFF	ON	OFF	OFF	ON
160h	ON	OFF	ON	OFF	OFF	ON	ON	ON
168h	ON	OFF	ON	OFF	OFF	ON	OFF	ON
170h	ON	OFF	ON	OFF	OFF	OFF	ON	ON
178h	ON	OFF	ON	OFF	OFF	OFF	OFF	ON
180h	ON	OFF	OFF	ON	ON	ON	ON	ON
188h	ON	OFF	OFF	ON	ON	ON	OFF	ON
190h	ON	OFF	OFF	ON	ON	OFF	ON	ON
198h	ON	OFF	OFF	ON	ON	OFF	OFF	ON
1A0h	ON	OFF	OFF	ON	OFF	ON	ON	ON
1A8h	ON	OFF	OFF	ON	OFF	ON	OFF	ON
1B0h	ON	OFF	OFF	ON	OFF	OFF	ON	ON
1B8h	ON	OFF	OFF	ON	OFF	OFF	OFF	ON
1C0h	ON	OFF	OFF	OFF	ON	ON	ON	ON
1C8h	ON	OFF	OFF	OFF	ON	ON	OFF	ON
1D0h	ON	OFF	OFF	OFF	ON	OFF	ON	ON
1D8h	ON	OFF	OFF	OFF	ON	OFF	OFF	ON
1E0h	ON	OFF	OFF	OFF	OFF	ON	ON	ON
1E8h	ON	OFF	OFF	OFF	OFF	ON	OFF	ON
1F0h	ON	OFF	OFF	OFF	OFF	OFF	ON	ON
1F8h	ON	OFF	OFF	OFF	OFF	OFF	OFF	ON

I/O	SW-1	SW-2	SW-3	SW-4	SW-5	SW-6	SW-7	SW-8
200h	OFF	ON	ON	ON	ON	ON	ON	ON
208h	OFF	ON	ON	ON	ON	ON	OFF	ON
210h	OFF	ON	ON	ON	ON	OFF	ON	ON
218h	OFF	ON	ON	ON	ON	OFF	OFF	ON
220h	OFF	ON	ON	ON	OFF	ON	ON	ON
228h	OFF	ON	ON	ON	OFF	ON	OFF	ON
230h	OFF	ON	ON	ON	OFF	OFF	ON	ON
238h	OFF	ON	ON	ON	OFF	OFF	OFF	ON
240h	OFF	ON	ON	OFF	ON	ON	ON	ON
248h	OFF	ON	ON	OFF	ON	ON	OFF	ON
250h	OFF	ON	ON	OFF	ON	OFF	ON	ON
258h	OFF	ON	ON	OFF	ON	OFF	OFF	ON
260h	OFF	ON	ON	OFF	OFF	ON	ON	ON
268h	OFF	ON	ON	OFF	OFF	ON	OFF	ON
270h	OFF	ON	ON	OFF	OFF	OFF	ON	ON
278h	OFF	ON	ON	OFF	OFF	OFF	OFF	ON
280h	OFF	ON	OFF	ON	ON	ON	ON	ON
288h	OFF	ON	OFF	ON	ON	ON	OFF	ON
290h	OFF	ON	OFF	ON	ON	OFF	ON	ON
298h	OFF	ON	OFF	ON	ON	OFF	OFF	ON
2A0h	OFF	ON	OFF	ON	OFF	ON	ON	ON
2A8h	OFF	ON	OFF	ON	OFF	ON	OFF	ON
2B0h	OFF	ON	OFF	ON	OFF	OFF	ON	ON
2B8h	OFF	ON	OFF	ON	OFF	OFF	OFF	ON
2C0h	OFF	ON	OFF	OFF	ON	ON	ON	ON
2C8h	OFF	ON	OFF	OFF	ON	ON	OFF	ON
2D0h	OFF	ON	OFF	OFF	ON	OFF	ON	ON
2D8h	OFF	ON	OFF	OFF	ON	OFF	OFF	ON
2E0h	OFF	ON	OFF	OFF	OFF	ON	ON	ON
2E8h	OFF	ON	OFF	OFF	OFF	ON	OFF	ON
2F0h	OFF	ON	OFF	OFF	OFF	OFF	ON	ON
2F8h	OFF	ON	OFF	OFF	OFF	OFF	OFF	ON

*continued on next page*

I/O	SW-1	SW-2	SW-3	SW-4	SW-5	SW-6	SW-7	SW-8
300h	OFF	OFF	ON	ON	ON	ON	ON	ON
308h	OFF	OFF	ON	ON	ON	ON	OFF	ON
310h	OFF	OFF	ON	ON	ON	OFF	ON	ON
318h	OFF	OFF	ON	ON	ON	OFF	OFF	ON
320h	OFF	OFF	ON	ON	OFF	ON	ON	ON
328h	OFF	OFF	ON	ON	OFF	ON	OFF	ON
330h	OFF	OFF	ON	ON	OFF	OFF	ON	ON
338h	OFF	OFF	ON	ON	OFF	OFF	OFF	ON
340h	OFF	OFF	ON	OFF	ON	ON	ON	ON
348h	OFF	OFF	ON	OFF	ON	ON	OFF	ON
350h	OFF	OFF	ON	OFF	ON	OFF	ON	ON
358h	OFF	OFF	ON	OFF	ON	OFF	OFF	ON
360h	OFF	OFF	ON	OFF	OFF	ON	ON	ON
368h	OFF	OFF	ON	OFF	OFF	ON	OFF	ON
370h	OFF	OFF	ON	OFF	OFF	OFF	ON	ON
378h	OFF	OFF	ON	OFF	OFF	OFF	OFF	ON
380h	OFF	OFF	OFF	ON	ON	ON	ON	ON
388h	OFF	OFF	OFF	ON	ON	ON	OFF	ON
390h	OFF	OFF	OFF	ON	ON	OFF	ON	ON
398h	OFF	OFF	OFF	ON	ON	OFF	OFF	ON
3A0h	OFF	OFF	OFF	ON	OFF	ON	ON	ON
3A8h	OFF	OFF	OFF	ON	OFF	ON	OFF	ON
3B0h	OFF	OFF	OFF	ON	OFF	OFF	ON	ON
3B8h	OFF	OFF	OFF	ON	OFF	OFF	OFF	ON
3C0h	OFF	OFF	OFF	OFF	ON	ON	ON	ON
3C8h	OFF	OFF	OFF	OFF	ON	ON	OFF	ON
3D0h	OFF	OFF	OFF	OFF	ON	OFF	ON	ON
3D8h	OFF	OFF	OFF	OFF	ON	OFF	OFF	ON
3E0h	OFF	OFF	OFF	OFF	OFF	ON	ON	ON
3E8h	OFF	OFF	OFF	OFF	OFF	ON	OFF	ON
3F0h	OFF	OFF	OFF	OFF	OFF	OFF	ON	ON
3F8h	OFF	OFF	OFF	OFF	OFF	OFF	OFF	ON

### *Setting the Interrupt Status Register Address*

PC/X boards have a special Interrupt Status register, which permits all ports on a board (or up to four boards, if they are daisy chained together; see Daisy Chaining PC/X Boards, on page 43) to operate efficiently with a single IRQ line. When any port requires servicing, the board generates an interrupt, and the Interrupt Status register identifies which port requires attention. In this way, software does not have to poll all of the ports to locate the one that generated the interrupt request.

The Interrupt Status register occupies two bytes on the computer's I/O bus, and its address is defined by DIP switch DS1 on the PC/X board. DS1 is a ten position switch, the breakdown of which is shown in Figure 3.

**Figure 3** **Breakdown of DIP Switch DS1**

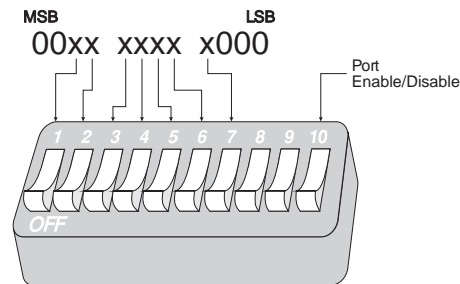

The I/O port address for the Interrupt Status register is set by switches 1-7, in the same way as the I/O port addresses for the individual channels on the board (see Setting the I/O Port Address, on page 4). Note that switches 8 and 9 should always be in the ON position.

Switch 10 enables (ON) or disables (OFF) the Interrupt Status register.

### *Setting the IRQ*

PC/4 and PC/8 boards support one or two IRQ (Interrupt Request) lines per board. If two interrupts are used, one must be ODD (IRQ 3, 5 or 7) and the other must be EVEN (IRQ 2, 4 or 6).

Select the interrupt(s) to be used by placing a jumper on J85, J86 or J87 for IRQ 3, 5 or 7, respectively, and/or J88, J89 or J90 for IRQ 6, 4 or 2, respectively.

Now assign each channel to either the ODD or EVEN interrupt by placing jumpers on J1-J8: for the ODD interrupt, jumper pins 1 and 2 (the top two pins); for the EVEN interrupt, jumper pins 2 and 3 (the bottom two pins). J1-J8 correspond to ports 1-8, respectively.

Finally, make sure that jumpers J9 and J10 are installed on pins 2 and 3 (the bottom two pins). This sets the board number to 0. All boards must be set to number 0 unless they are daisy chained to other PC/X boards .

#### **Important!**

Individual PC/X boards must each be assigned a unique IRQ, which must not be used by any other device in your system, including other PC/X boards, *unless the PC/X boards are daisy chained together* (see Daisy Chaining PC/X boards, on page 43).

#### **Note:**

Dual interrupt capability is provided to facilitate emulation of standard ports COM1-COM4, which use IRQs 3 and 4 (see the section on MS-DOS applications, beginning on page 49).

If you are not emulating standard COM ports, use one IRQ line; performance is not affected, and you'll have more IRQs available for other devices.

Some common sources of contention for IRQs are:

- IRQ2: EGA adapters (if present)
- IRQ3: Standard COM2 & COM4 ports (if present)
- IRQ4: Standard COM1 & COM3 ports (if present)
- IRQ5: LPT2 (Second parallel printer port) (if present)
- IRQ6: Floppy disk controller
- IRQ7: LPT1 (First parallel printer port) (if present)

Table 2 below shows the required jumper placement for setting all ports for operation with each of the six supported interrupts. The last entry of the table shows how to set the first port for IRQ4, and the remaining ports for IRQ3 (see the note on the previous page).

**Table 2** IRQ Selection for PC/4 and PC/8 Boards

IRQ	J85-J90	J1-J10
2		
3		
4		
5		
6		
7		
3&4		

**Note:**

PC/4 boards do not have jumpers J5-J8.



### Board Identification

Jumpers J9 and J10 (see Figure 1) are used to set the PC/8 and PC/4 boards' ID number (0-3) when multiple boards are daisy chained together (see Daisy Chaining PC/X Boards, on page 43). The default Board ID is 0; this should be changed *only for the second, third and fourth boards in a daisy chained configuration.*

**Figure 4 Board ID Jumper Settings for PC/4 and PC/8 Boards**

**Board 0:**

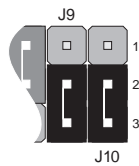

**Board 1:**

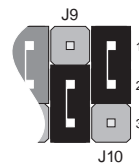

**Board 2:**

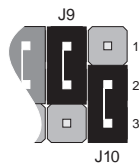

**Board 3:**

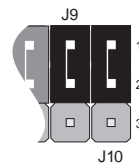

### ***Daisy Chain Connectors P2 and P3***

In the upper right-hand corner of the PC/4 or PC/8 board are two connectors, P2 and P3 (see Figure 1). When multiple boards are daisy chained together (see Daisy Chaining PC/X Boards, on page 43), a daisy chain cable links the boards so that they can share a single IRQ line. For single board installations, a jumper must be placed across pins 2 and 3 (the middle two pins) of P2 when an ODD interrupt is selected, P3 when an EVEN interrupt is selected, and both P2 and P3 if ODD and EVEN interrupts are selected. PC/X boards are shipped with both jumpers installed, and the usual practice is to leave them both in place, even if you are only using one interrupt. See Figure 5, below.

**Figure 5      Connectors P2 and P3 (Single Board Configuration)**

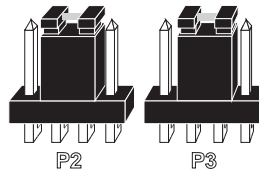

## Plugging in the Board

Now you are ready to install the PC/X board in your computer. Follow these steps:

1. Turn off your computer's power and remove the cover (refer to your computer's manual for instructions on cover removal and option board installation and cautions).
2. Locate an available slot (8 or 16 bit) in your computer and remove the slot plate.
3. Plug the PC/X board into the slot and screw the endplate to the computer chassis (use the screw you removed from the slot plate). The endplate must be screwed in to the computer chassis to remain in compliance with Part 15 of the FCC rules for class B operation.
4. Install the interface cable assembly or connector box (see *Connector Options*, on page 35) on the PC/X board by mating the female 78-pin connector on the assembly to the male 78-pin connector on the end of the PC/X board. *Be sure that the plug is completely installed—it may be a snug fit.*

*HINT: If you have difficulty plugging in the DB-78 connector, try loosening the screw in the endplate—the connector may not be exactly centered in the slot in the back of the computer. Be sure to re-tighten the endplate screw once the DB-78 connector is securely attached.*

**IMPORTANT! Use only the DigiBoard-supplied shielded cable assemblies or connector boxes to remain in compliance with FCC limits for Class B operation.**

5. Replace your computer's cover.

## PC/16 Boards

### Before you plug in the board. . .

Write down the serial number of the board in the form on page *x*. You will need it if you have to contact DigiBoard regarding the board. Also write down the part numbers of the PAL chips in sockets U46 and U58 (see Figure 6); it is essential to know these part numbers so you can determine what I/O port addresses correspond to each of the ports on the board.

**Figure 6** **PC/16 Board Layout**

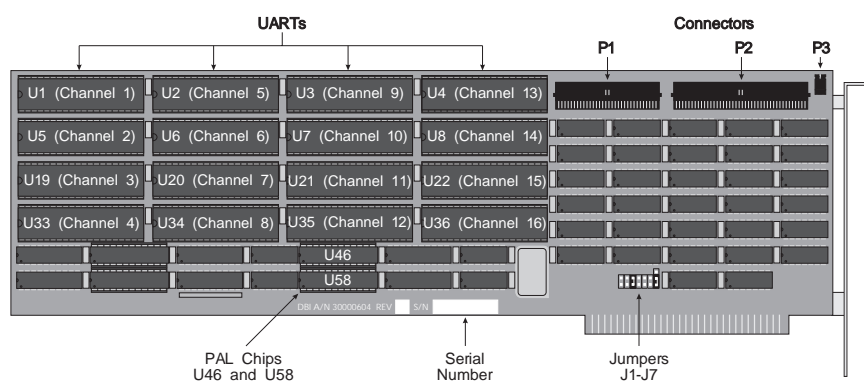

### I/O Port Addresses

The PC/16 board's I/O port addresses are not set by DIP switches. Instead, the addresses are "hard coded" in two PAL (Programmable Array Logic) chips on the board. The PALs are plugged into sockets at locations U46 and U58 (see Figure 6). The part numbers of the PALs can be used to identify the I/O addresses that are used by a particular PC/16 board.

#### **Important!**

Since the PC/16 board's I/O addresses are hard coded, they cannot be changed in the event of conflict with another device in your system. These conflicts are very rare, but if one should occur, you will need to change the I/O port used by the other device to an address that is not being used by the PC/16 board(s). Tables 3 and 4 on the following pages show the addresses coded in the PC/16 boards' PALs.

There are two main sets of PALs available for PC/16 boards: Standard (for MS-DOS, OS/2, Windows, etc.) and Pick (for the Pick operating system). These main sets contain two pairs of PALs—one for Board 0 and one for Board 1.

**Important!**

If two PC/16 boards are to be installed in the same computer, they must have different PAL sets, or I/O address conflicts will occur. See Tables 3 and 4 for the appropriate part numbers for Board 0 and Board 1 PALs.

**Table 3 Standard (DOS) PALs and their Associated I/O Addresses**

Board 0		Board 1	
PAL #40000246 (U58) PAL #40000247 (U46)		PAL #40000248 (U58) PAL #40000249 (U46)	
Port	I/O Address	Port	I/O Address
1	100h	1	188h
2	108h	2	190h
3	110h	3	198h
4	118h	4	208h
5	120h	5	210h
6	128h	6	218h
7	130h	7	220h
8	138h	8	228h
9	148h	9	230h
10	150h	10	238h
11	158h	11	240h
12	160h	12	248h
13	168h	13	250h
14	170h	14	258h
15	178h	15	260h
16	180h	16	268h
Status Register	140h	Status Register	140h

**Table 4 Pick PALs and their Associated I/O Addresses**

<b>Board 0</b>		<b>Board 1</b>	
PAL #40000238 (U58) PAL #40000239 (U46)		PAL #40000240 (U58) PAL #40000241 (U46)	
<b>Port</b>	<b>I/O Address</b>	<b>Port</b>	<b>I/O Address</b>
1	130h	1	230h
2	138h	2	238h
3	140h	3	240h
4	148h	4	248h
5	150h	5	250h
6	158h	6	258h
7	160h	7	260h
8	168h	8	268h
9	1B0h	9	2B0h
10	1B8h	10	2B8h
11	1C0h	11	2C0h
12	1C8h	12	2C8h
13	1D0h	13	2D0h
14	1D8h	14	2D8h
15	1E0h	15	2E0h
16	1E8h	16	2E8h
Status Register	188h	Status Register	289h

### IRQ Selection

The PC/16 board can be configured to use one of six IRQ (Interrupt Request) lines: IRQ2, IRQ3, IRQ4, IRQ5, IRQ6 or IRQ7. Jumpers J1-J6 (see Figure 6) determine which IRQ the board will use. To set the IRQ for the PC/16 board, place a jumper across the appropriate pair of pins, as shown in Table 5, below.

**Table 5** **PC/16 IRQ Jumper Settings**

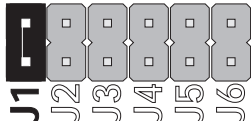
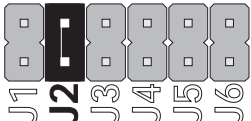
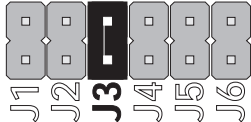
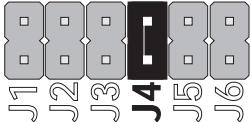
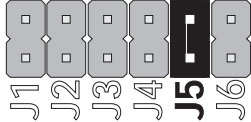
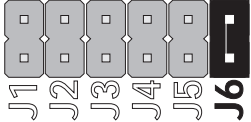
 <p>J1 J2 J3 J4 J5 J6</p> <p>IRQ2 - J1 Jumpered</p>	 <p>J1 J2 J3 J4 J5 J6</p> <p>IRQ3 - J2 Jumpered</p>
 <p>J1 J2 J3 J4 J5 J6</p> <p>IRQ4 - J3 Jumpered</p>	 <p>J1 J2 J3 J4 J5 J6</p> <p>IRQ5 - J4 Jumpered</p>
 <p>J1 J2 J3 J4 J5 J6</p> <p>IRQ6 - J5 Jumpered</p>	 <p>J1 J2 J3 J4 J5 J6</p> <p>IRQ7 - J6 Jumpered</p>

The IRQ selected for the PC/16 board must be unique, and may not be shared with any other device in the system, with one exception: two PC/16 boards may share the same IRQ, if the boards are “daisy chained” together (see Daisy Chaining PC/X Boards, on page 43).

Some common sources of contention for IRQs are:

- IRQ2: EGA adapters (if present)
- IRQ3: Standard COM2 & COM4 ports (if present)
- IRQ4: Standard COM1 & COM3 ports (if present)
- IRQ5: LPT2 (Second parallel printer port) (if present)
- IRQ6: Floppy disk controller
- IRQ7: LPT1 (First parallel printer port) (if present)

### ***Board Identification***

Jumper J7 (see Figure 6) is used to set the PC/16 board's ID number (0 or 1) when two boards are daisy chained together (see Daisy Chaining PC/X Boards, on page 43). The default Board ID is 0; this should be changed to 1 *only for the second board in a daisy chained pair of boards.*

**Figure 7** **PC/16 Board ID Jumper Settings**

---



Board 0: Pins 1 and 2 Connected



Board 1: Pins 2 and 3 Connected



### ***Daisy Chain Connector P3***

In the upper right-hand corner of the PC/16 board is a connector, P3 (see Figure 6). When two boards are daisy chained together (see Daisy Chaining PC/X Boards, on page 43), the daisy chain cable is connected between connector P3 of Board 0 and connector P3 of Board 1. *In all other cases, the two pins of P3 must be jumpered together as shown in Figure 8, below:*

**Figure 8** **PC/16 Daisy Chain Connector P3, with Jumper**

---



## Plugging in the Board

Once you have set all of the jumpers and noted the PAL part numbers (and the board's serial number!) you are ready to install the PC/16 board in your computer.

1. Locate a vacant full length eight or sixteen bit (XT or AT) slot in your computer and remove the end plate (save the screw).
2. Fold the cables from the RJ-45 connector box so that they line up with connectors P1 and P2 on the top edge of the board as shown in Figure 9.

**Figure 9** **Folding the Interface Cables**

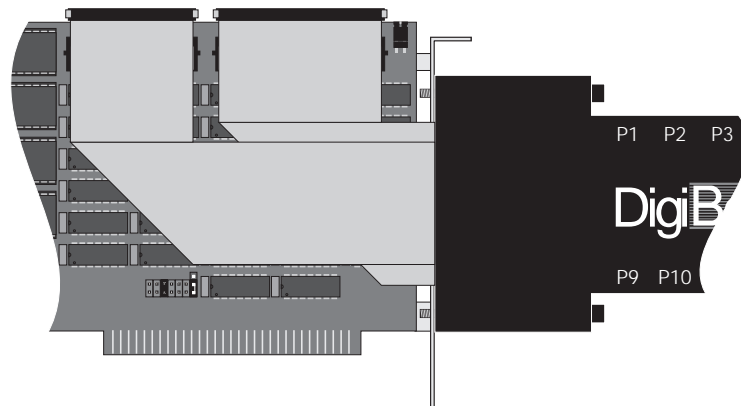

3. Feed the cables through the open slot in the back of the computer.
4. Plug the board into the selected I/O slot in the computer. Use the screw you removed in Step 1 to secure the board to the computer chassis. The endplate must be screwed in to the computer chassis to remain in compliance with Part 15 of the FCC rules for class B operation.
5. Screw the connector box to the end plate of the PC/16 board.
6. Plug the connector box ribbon cables into connectors P1 and P2 on the top of the board.

## MC/X Boards

This section provides instructions for installing and configuring MC/4, MC/8 and MC/16 boards in Micro Channel computers. These boards are for use with IBM PS/2 and compatible computers which use Micro Channel bus architecture.

Instructions for installing PC/X boards (in ISA computers) begin on page 3.

### Before you plug in the board. . .

**Write down the serial number of the board in the form on page *x*. You will need it if you have to contact DigiBoard regarding the board.**

Make sure you have the following items at hand:

- *Working* copy of your IBM Reference Diskette (don't use the original—it should be write-protected and stored in a safe place)
- ADF (Adapter Description Files) diskette (supplied with the board)

If you are installing a MC/16 board, remove the cover from the connector “tail” (replace the cover after the board has been installed in the computer).

**Figure 10**

**MC/4 and MC/8 Board Layout**

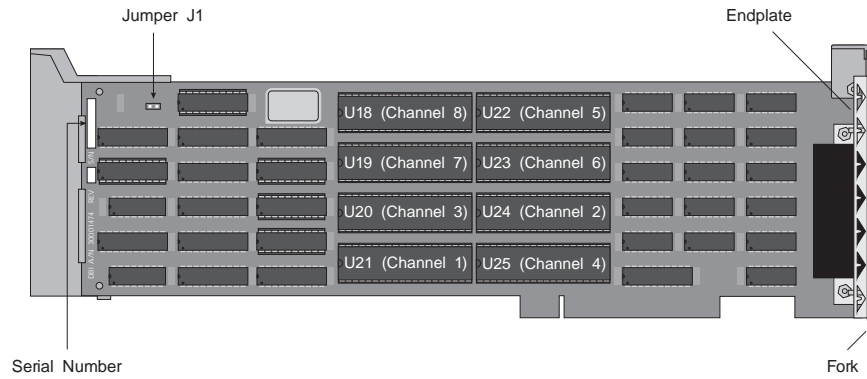

**Figure 11**

**MC/16 Board Layout**

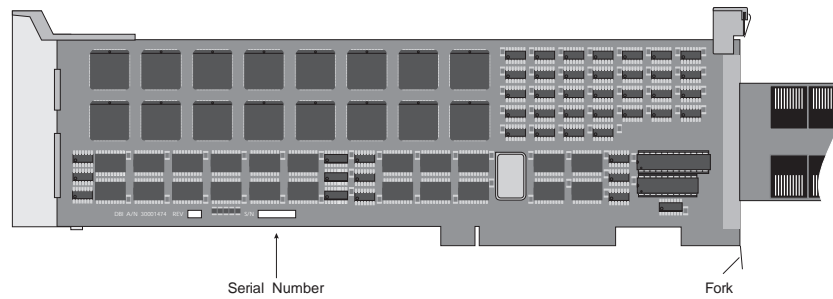

**Important!**

MC/X boards contain static-sensitive components. Always touch a grounded surface to discharge static electricity before handling the circuit board.

## Plugging in the Board

Now you are ready to install the MC/X board in your computer. Follow these steps:

1. Turn off your computer's power and remove the cover (refer to your computer's manual for instructions on cover removal and option board installation and cautions).
2. Locate an available Micro Channel slot in your computer and remove the external slot plate (you will need to loosen the thumbscrew to do this). If you are installing an MC/16 board, also make sure that there is at least six inches of clearance behind the computer for the RJ-45 connector tail.
3. Plug the MC/X board into the Micro Channel slot, making sure that the "fork" is in position under the endplate thumbscrew. Tighten the thumbscrew.
4. (MC/16 only) Be sure to replace the cover on the connector tail. This is required in order to remain in compliance with Part 15 of the FCC rules for Class B operation.
5. Replace your computer's cover.

## Configuring the Board

After the MC/X board has been physically installed in your machine, you need to configure the board for operation in your system. This is done by running the configuration program on the IBM Reference Diskette. Follow these steps:

1. Insert your working copy of the IBM Reference Diskette into your boot drive (Drive A) and turn on the computer's power. Expect an error message—the MC/X board won't be found in the configuration file at this point.
2. Select "Copy an Option Diskette" from the main menu. Follow the instructions given on your computer screen for copying ADF files onto your Reference Diskette. The name of the ADF file for MC/4 and MC/8 boards is **@6FE5.ADF**. The ADF file for MC/16 boards is **@6FE4.ADF**.
3. Select "Set Configuration" from the main menu. Then select "Change Configuration" from the Set Configuration menu. The screen will now display the configuration of the system. Use the <Page UP> and <Page Down> keys to scroll through the configuration until you see the entry for the slot into which you have plugged the MC/X board. There are three parameters which can be set: I/O Port Address, Com2 Status and Interrupt Select.

To change a parameter, use the arrow keys to highlight the item you wish to change, then press the <F5> and <F6> function keys to cycle through the available settings for that parameter.

When you have set all three parameters to the desired values, press <F10> to save the changes, then press <F3> to exit.

The following options are available:

**MC/4, MC/8 I/O Port Address:**

**0xDB80 → 0xDBC0**

DB80h DB88h DB90h DB98h  
DBA0h DBA8h DBB0h DBB8h  
Status Register: DBC0h

**0xDC00 → 0xDC40**

DC00h DC08h DC10h DC18h  
DC20h DC28h DC30h DC38h  
Status Register: DC40h

**0xBB80 → 0xBBC0**

BB80h BB88h BB90h BB98h  
BBA0h BBA8h BBB0h BBB8h  
Status Register: BBC0h

**0xBC00 → 0xBC40**

BC00h BC08h BC10h BC18h  
BC20h BC28h BC30h BC38h  
Status Register: BC40h

**0xAB80 → 0xABC0**

AB80h AB88h AB90h AB98h  
ABA0h ABA8h ABB0h ABB8h  
Status Register: ABC0h

**0xAC00 → 0xAC40**

AC00h AC08h AC10h AC18h  
AC20h AC28h AC30h AC38h  
Status Register: AC40h

**0xCB80 → 0xCBC0**

CB80h CB88h CB90h CB98h  
CBA0h CBA8h CBB0h CBB8h  
Status Register: CBC0h

If you are installing an MC/4 board, only the first four addresses in each list are pertinent.

**MC/16 I/O Port Address:**

**0x3000 → 0x307F**

3000h	3008h	3010h	3018h	3020h	3028h	3030h	3038h
3040h	3048h	3050h	3058h	3060h	3068h	3070h	3078h.

**0x4000 → 0x407F**

4000h	4008h	4010h	4018h	4020h	4028h	4030h	4038h
4040h	4048h	4050h	4058h	4060h	4068h	4070h	4078h

**0x4100 → 0x417F**

4100h	4108h	4110h	4118h	4120h	4128h	4130h	4138h
4140h	4148h	4150h	4158h	4160h	4168h	4170h	4178h

**0x4200 → 0x427F**

4200h	4208h	4210h	4218h	4220h	4228h	4230h	4238h
4240h	4248h	4250h	4258h	4260h	4268h	4270h	4278h

**0x4300 → 0x437F**

4300h	4308h	4310h	4318h	4320h	4328h	4330h	4338h
4340h	4348h	4350h	4358h	4360h	4368h	4370h	4378h

**0x5000 → 0x507F**

5000h	5008h	5010h	5018h	5020h	5028h	5030h	5038h
5040h	5048h	5050h	5058h	5060h	5068h	5070h	5078h

**0x6000 → 0x607F**

6000h	6008h	6010h	6018h	6020h	6028h	6030h	6038h
6040h	6048h	6050h	6058h	6060h	6068h	6070h	6078h

**0x7000 → 0x707F**

7000h	7008h	7010h	7018h	7020h	7028h	7030h	7038h
7040h	7048h	7050h	7058h	7060h	7068h	7070h	7078h

**MC/16 Status Register Address:**

**0x3080 → 0x3081**

**0x4080 → 0x4081**

**0x4180 → 0x4181**

**0x4280 → 0x4281**

**0x4380 → 0x4381**

**0x5080 → 0x5081**

**0x6080 → 0x6081**



**Com2 Status:**

When Com2 Status is enabled, the first port on the MC/X board is given an I/O port address of 2F8h and assigned to interrupt IRQ3, regardless of the settings of the other parameters. This makes the first port look like a standard COM2 port. *If your machine already has a COM2 serial port, there will be address and interrupt conflicts between the two devices.*

**Interrupt Vectors:**

IRQ 3, 5, 7, 10, 11, 12, 15 or None (IRQ disabled).

Make a note of the UART Address Range and the Interrupt Select. You will need this information when setting up device drivers. Also verify that "Com2 Status" is set to "Disabled". If it is not, you can change it by selecting the "Set Configuration" menu.

4. Remove the Reference Diskette from the drive and reboot your machine. This time you should get no error message.

## Connecting Peripherals

This section provides information on the most common peripheral connection schemes for terminals, printers and modems. See *RS-232 Serial Interface*, beginning on page 34, for a more comprehensive discussion of serial interface options.

### **Important!**

When connecting peripheral devices to the PC/X or MC/X board, be sure to turn off the power to both the host computer and the peripheral device.

## Terminals and Printers

### *Software Handshaking (XON/XOFF)*

In most cases, serial terminals and printers need only a “three-wire” connection. All DigiBoard PC/X and MC/X device driver software supports XON/XOFF (software) handshaking, so the only signal lines necessary are Transmitted Data (TxD), Received Data (RxD) and Signal Ground (SG). It may be necessary to disable DCD (Data Carrier Detect) sensing through a software command—see your DigiBoard device driver software manual for instructions. Cables must be shielded to remain in compliance with FCC certification requirements, and the shield should be connected to Chassis Ground (GND) at both ends of the cable run.

A simple cable for connecting a terminal or a printer to a PC/X or MC/X board is shown in Figure 12 (DB-25 versions) and Figure 13 (RJ-45 versions).

**Figure 12 Simple Terminal/Printer Cable (DB-25)**

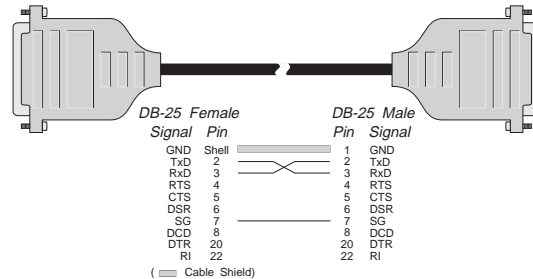

**Figure 13 Simple Terminal/Printer Cable (RJ-45)**

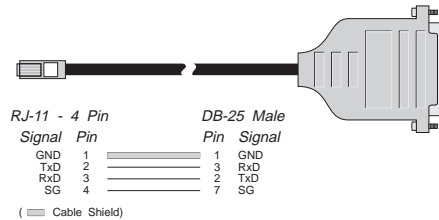

The cables shown in Figures 12 and 13 are three-wire null modem cables—that is, Transmitted Data on one end of the cable is connected to Received Data at the other end, and vice versa.

*DB-25 Equipped Boards:*

The male DB-25 end can be plugged directly into most serial terminals and printers without any adapters. The female DB-25 end plugs directly into one of the DB-25 connectors on the fan out cable or connector box assembly.

*RJ-45 Equipped Boards:*

The male DB-25 end can be plugged directly into most serial terminals and printers without any adapters. The RJ-11 plug fits in the center of the PC/X or MC/X board's RJ-45 jack.

### Hardware Handshaking (Ready/Busy)

Most terminals and printers use Data Terminal Ready (DTR) for Ready/Busy hardware handshaking. The cables below support this method (see note on the following page).

**Figure 14 Terminal/Printer Cable with DTR Handshaking (DB-25)**

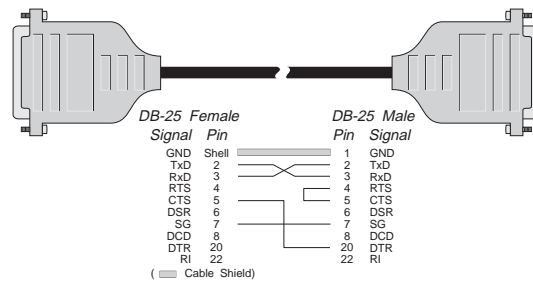

**Figure 15 Terminal/Printer Cable with DTR Handshaking (RJ-45)**

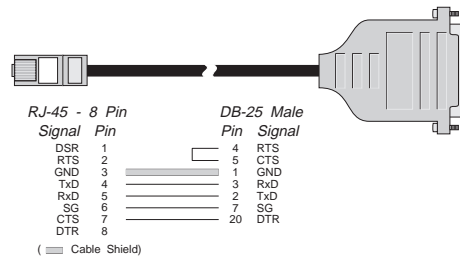

**Note:**

Some Okidata printers use a control signal on pin 11, called Supervisory Send Data (SSD) instead of DTR. In this case, simply connect CTS on the RJ-45 side to pin 11 of the DB-25, instead of pin 20.

Other printer manufacturers may use different methods of flow control. Consult your printer's documentation for specific wiring requirements.

## Modems

### DB-25 Versions

Use a standard “straight-through” cable (see Figure 16) to connect a modem to one of the DB-25 connectors on the fan out cable or connector box.

**Figure 16** **Modem Cable (DB-25)**

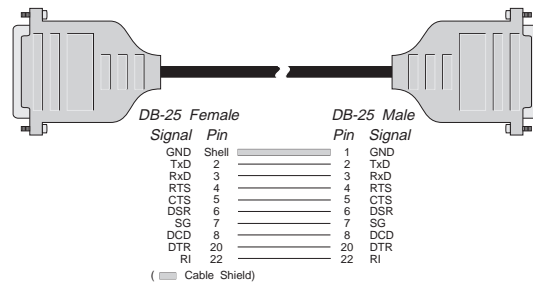

### RJ-45 Versions

The simplest way to connect a modem to a board with RJ-45 connectors is to use RJ-45 to DB-25 “Cable Legs”, available from DigiBoard (see page 41 for a description and part numbers). These adapters use 10-pin RJ-45 plugs, and therefore provide full modem support (Ring Indicator and Data Carrier Detect are only available on 10-pin RJ-45 connectors).

If you wish to build your own modem cables, follow the diagram in Figure 17.

**Figure 17** **Full 10-Wire Modem Cable (RJ-45)**

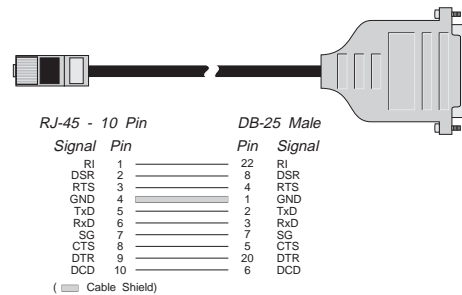

### ***ALTPIN Modem Wiring (RJ-45 Versions)***

10-pin RJ-45 plugs may be difficult to obtain in the retail market; therefore, DigiBoard device driver software incorporates an optional feature called ALTPIN, which swaps the logical functions of DSR (Data Set Ready) with DCD (Data Carrier Detect). When ALTPIN is enabled (see your device driver software reference manual for instructions), DCD becomes available on pin 1 of an 8-pin RJ-45 connector (equivalent to pin 2 of a 10-pin connector).

If you wish to build an 8-wire modem cable for the PC/X or MC/X board, use an 8-pin RJ-45 plug wired as follows:

**Figure 18 8-Wire Modem Cable for use with ALTPIN Configuration**

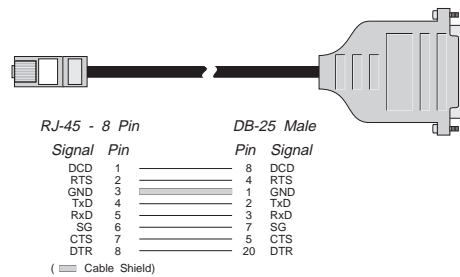

# RS-232 Cables and Connector Options

---

## Cables

RS-232 serial interface cables should be shielded, low-capacitance cables, ideally designed specifically for serial data transmission.

## Grounding

The shield should be grounded at both ends of the cable. Chassis Ground—available on the shell of DigiBoard's DB-25 and DB-9 connectors, and pin 4 of our 10-pin RJ-45 connector, is ideal for this purpose.

## Environment

While good shielding provides reasonable protection against “noise” (Electro-Magnetic Interference, or EMI), cables should still be routed away from noise sources wherever possible. Avoid laying cables in close proximity to transformers, generators, motors, fluorescent lights, etc.

## Capacitance vs. Length of Run

The total capacitance of a cable affects the integrity of transmitted data. As a rule of thumb, the *total* capacitance of a cable (including the connectors) should not exceed 2500 pF. Serial interface cable is usually rated in pico Farads per foot. Therefore, if a cable has a capacitance of 50 pF/ft, and the connectors are 100 pF each, the maximum recommended cable length is 46 feet. If the cable is rated at 12.5 pF/ft, the maximum recommended cable length is 184 feet, and 5 pF/ft cable can be run up to 460 feet.

In situations where low-capacitance cable is unavailable, or very long cable runs are required, “short-haul” modems, available from suppliers such as Black Box, can be used to increase the effective range of the RS-232 interface. Short-haul modems are similar to standard modems, except that they are connected directly to each other via a cable instead of going through a telephone circuit. *NOTE—Use only externally-powered short-haul modems with DigiBoard products.*

## Connector Options

A variety of connector types are available. Four and eight port PC/X and MC/X boards can be set up with DB-25 connectors (male or female, DTE or DCE wiring), DB-9 connectors (male or female, DTE wiring) or 10-pin RJ-45 jacks.

**NOTE: PC/16 and MC/16 boards are available only with RJ-45 connectors.**

The following pages give the part numbers and wiring information for the various connector types.

## DB-25 Connectors

DigiBoard PC/X and MC/X boards can be configured with DB-25 connectors in any of four configurations: DTE male, DTE female, DCE male or DCE female. The pin assignments for the DB-25 connectors follow the usual conventions for RS-232 wiring.

**Table 6** **DB-25 Connector Pin Assignments**

Signal	Description	DTE Use	DCE Use	Pin #
GND	Chassis Ground	N/A	N/A	Shell
TxD	Transmitted Data	Output	Input	2
RxD	Received Data	Input	Output	3
RTS	Request to Send	Output	Input	4
CTS	Clear to Send	Input	Output	5
DSR	Data Set Ready	Input	Output	6
SG	Signal Ground	<i>reference</i>	<i>reference</i>	7
DCD	Data Carrier Detect	Input	Output	8
DTR	Data Terminal Ready	Output	Input	20
RI	Ring Indicator	Input	Output	22

It should be noted that the DCE configuration is equivalent to a DTE connector plus a fully-wired null modem adapter. Thus, DCD (Data Carrier Detect) and DSR (Data Set Ready) are wired together internally and carry the DTE equivalent of DTR (Data Terminal Ready). *For this reason, DCE cables cannot be used with modems.*



## DB-25 Connector Options

DB-25 connectors are available in two styles: a quad or octa cable assembly, or a connector box assembly. Either style may be ordered with male or female DB-25 connectors, configured as DTE or DCE devices.

### *Quad and Octa Cable Option (DTE or DCE)*

Figure 19 shows the eight-port cable assembly, and Table 7 gives the part numbers of the available configurations.

**Figure 19** **Octa-Cable Assembly**

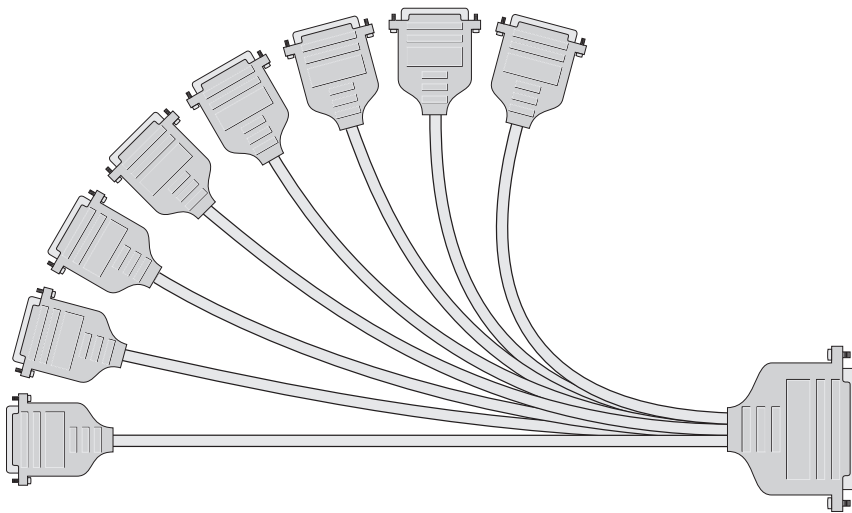

**Table 7** **DB-25 Cable Options and Part Numbers**

	<b>DTE Quad</b>	<b>DCE Quad</b>	<b>DTE Octa</b>	<b>DCE Octa</b>
<b>DB-25 Male</b>	76000008	76000007	76000021	76000020
<b>DB-25 Female</b>	76000006	76000005	76000019	76000018

*Quad and Octa Connector Boxes (DTE or DCE)*

**Figure 20**

**Eight-Port DB-25 Connector Box**

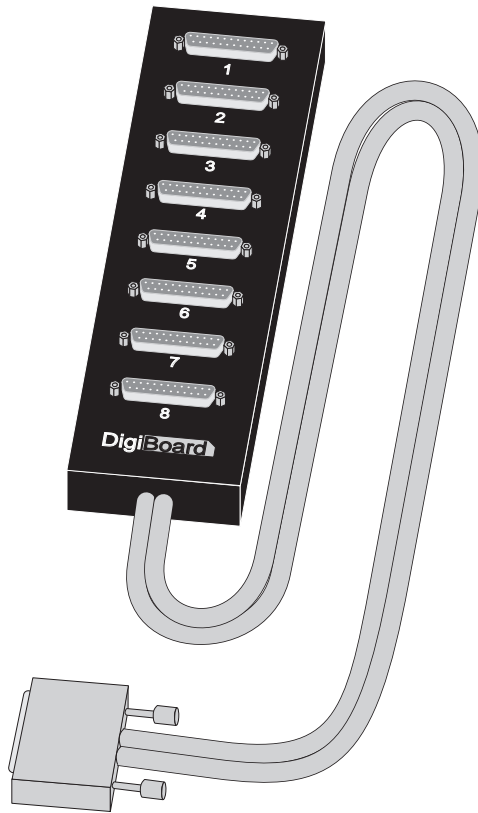

**Table 8 Connector Box Options and Part Numbers**

	<b>DTE Quad</b>	<b>DCE Quad</b>	<b>DTE Octa</b>	<b>DCE Octa</b>
<b>DB-25 Male</b>	76000030	76000028	76000031	76000029
<b>DB-25 Female</b>	76000026	76000024	76000027	76000025

## DB-9 Connectors

PC/X and MC/X boards can be configured with male or female DB-9 connectors (DTE wiring only).

**Table 9 DB-9 Connector Pin Assignments**

Signal	Description	Direction	Pin #
GND	Chassis Ground	N/A	Shell
DCD	Data Carrier Detect	Input	1
TxD	Transmitted Data	Output	3
RxD	Received Data	Input	2
DTR	Data Terminal Ready	Output	4
SG	Signal Ground	<i>reference</i>	5
DSR	Data Set Ready	Input	6
RTS	Request to Send	Output	7
CTS	Clear to Send	Input	8
RI	Ring Indicator	Input	9

DB-9 connectors are available only in the quad or octa cable “fan-out” configuration (see Figure 19, on page 36).

**Table 10 DB-9 Quad and Octa Cable Options and Part Numbers**

	Quad DTE	Octa DTE
<b>DB-9 Male</b>	76000003	76000015
<b>DB-9 Female</b>	76000001	76000013

## RJ-45 Connectors

PC/X and MC/X boards can be configured with 10-pin RJ-45 modular jacks. These accept plastic snap-in plugs like the ones used for connecting telephones. They are less bulky and more convenient to use than the DB-25, but have not undergone the standardization rigors that have been applied to the larger DB-25 connectors. Figure 21 shows the eight-port RJ-45 connector block, and Table 11 gives the applicable part numbers.

**Figure 21** **Eight-Port RJ-45 Connector Box**

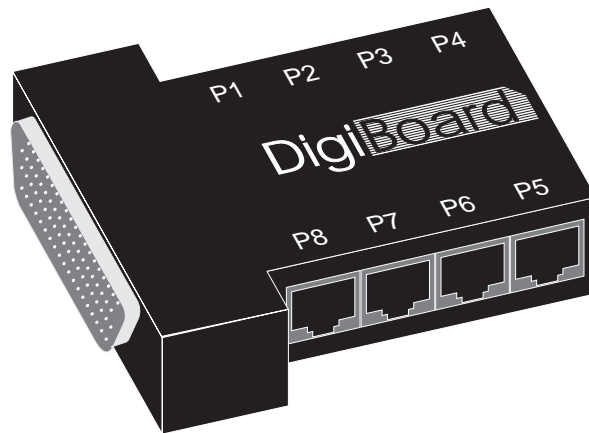

**Table 11** **RJ-45 Connector Box Options**

	Quad	Octa
RJ-45	76000038	76000033

## Modular Plugs

There are four types of modular plugs that can be used with DigiBoard's RJ-45 10-pin jack. These are the 4 or 6-pin RJ-11 plugs, and the 8 or 10-pin RJ-45 plugs.

The 8 and 10-pin RJ-45 plugs are the same physical size, but the 10-pin version has one additional wire at each end of the row of contacts. Thus pins 1-8 of an 8-pin RJ-45 directly correspond to pins 2-9 of a 10-pin RJ-45 connector.

Similarly, the two RJ-11 plugs have the same physical dimensions, but the 6-pin version has an extra pin at each end. The RJ-11 plugs are physically smaller than RJ-45 plugs, but are designed so that they fit into the *center* of an RJ-45 jack. In this way, the four pins closest to the center of any size connector will always carry the same signals as the middle four pins of any other connector. The contacts of a 6-pin RJ-11 connector correspond directly to the middle six pins of an 8 or 10-pin RJ-45 connector, and so on.

## RJ-45 to DB-25 Conversion

Since most RS-232 devices are equipped with DB-25 connectors, it is necessary to buy or build an adapter to transfer the signals to a DB-25 plug. The most simple and direct approach is to purchase ready-made “Cable Legs” from a DigiBoard dealer or distributor. These are made with a full 10-pin RJ-45 plug (which can be difficult to obtain in the retail market), connected via a two or four foot cable to a DTE-configured DB-25 plug.

**Figure 22** **RJ-45 to DB-25 “Cable Leg”**

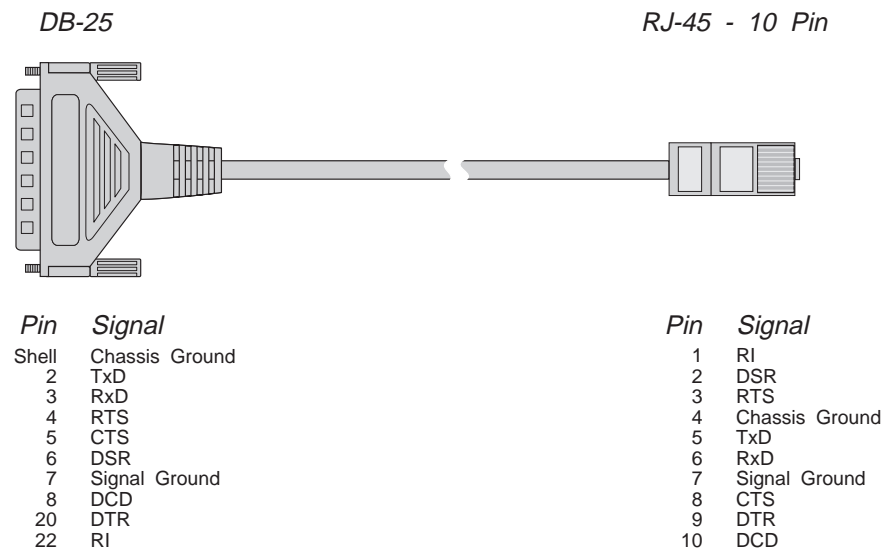

**Table 12** **Cable Leg Options and Part Numbers**

	DB-25 Male	DB-25 Female	DB-9 Male
<b>24 Inch Cables</b>	61020024	61030024	61070024
<b>48 Inch Cables</b>	61020048	61030048	N/A

The pin configuration of the DB-25 connector on the Cable Leg is identical to that of the DB-25 connectors on the standard DigiBoard DTE octa cable, and provides full modem control.

Since the cable leg's DB-25 connector is configured for DTE, you need a null modem cable or adapter for terminals and printers. See Figure 12 on page 30, and Figure 14 on page 31 for null modem configurations that can be used with cable legs.

If you don't need full modem control, you can use one of the many commercially available RJ-45 to DB-25 adapters. These have both an 8-pin RJ-45 jack and a DB-25 plug in a housing no larger than that found on a standard DB-25 plug. The plug and jack are connected within the housing by jumpers which may be installed by the end-user in any desired configuration.

# Daisy Chaining PC/X Boards

---

## PC/4 and PC/8 Boards

In some operating systems, such as MS-DOS and Pick, it is possible, or even necessary, to “daisy chain” multiple PC/X boards together on one or two interrupts. This, in effect, makes the entire group of boards appear to the system as one board. This may be done with up to four PC/4 and/or PC/8 boards, and with two PC/16 boards.

The PC/X board has an interrupt sequencer which cycles through each of the ports on the board, looking for an active interrupt request. When it finds one, it stops cycling, activates the interrupt request line for that port and waits for the interrupt to be serviced by the host computer. Once the interrupt has been handled, the sequencer starts up again and continues in this manner until the last port is polled. At this point the sequencer’s counter is reset and a token output is sent to pin 2 of either P-2 (for odd-numbered interrupts) or P-3 (for even-numbered interrupts). In a single-board system, this token passes through a jumper shunt and back into pin 3 of the same connector, and restarts the interrupt sequencer’s polling cycle. In a multi-board system, the signal passes through the daisy-chain cable to pin 3 of the same connector of the next board in sequence. Pin 2 of the last board is connected to pin 3 of the first board, closing the loop. In this manner, all ports of all boards are polled in each cycle.

When multiple boards will be sharing interrupt request lines, the interrupt status registers of each board MUST be set to the same address (set by the 10-position switch bank DS-1). When reading the status port to find the particular channel generating an interrupt, the ODD interrupt is checked at the address selected on DS-1, and the EVEN interrupt is checked at that address plus 1. Thus, if the status register is addressed at 140h (the default setting), the ODD interrupt status is found at address 140h and the EVEN interrupt status is found at 141h.

The status port reflects the board number in bits 3 and 4 as a binary number between 0 and 3. Bits 0, 1 and 2 contain a binary number between 0 and 7 indicating the number of the channel that needs servicing. Thus, if the status port contains 16h, or 00010110 binary, the third board (board #2) has an interrupt pending on channel 6 (or the 7th physical port—remember that the first board or port is number 0). If no interrupt is pending, the status port will contain FFh (all bits set to 1).



If more than one interrupt is pending, the status port will reflect the first one. Once that interrupt has been serviced, the next one in numerical sequence will appear in the status port. Therefore, by reading the status port until it comes up FFh, all pending interrupts will have been serviced.

The following figures show the necessary wiring for one to four boards (a single board system is shown for completeness). Note that if only one interrupt is used (which is recommended, since no performance improvement will be seen by using two), only one set of cables is needed: install cables on connector P2 for ODD interrupts, or P3 for even interrupts.

**Figure 23** **Single Board System (PC/4, PC/8)**

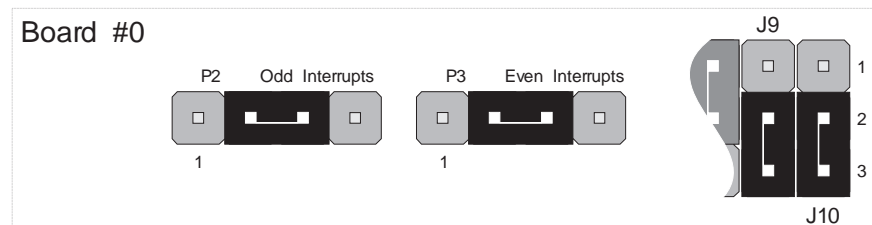

**Figure 24** **Two Board System (PC/4, PC/8)**

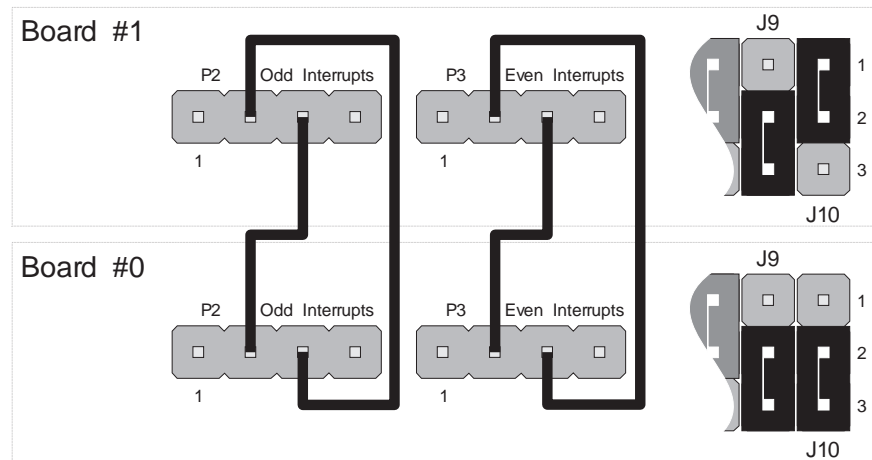

**Figure 25**

**Three Board System (PC/4, PC/8)**

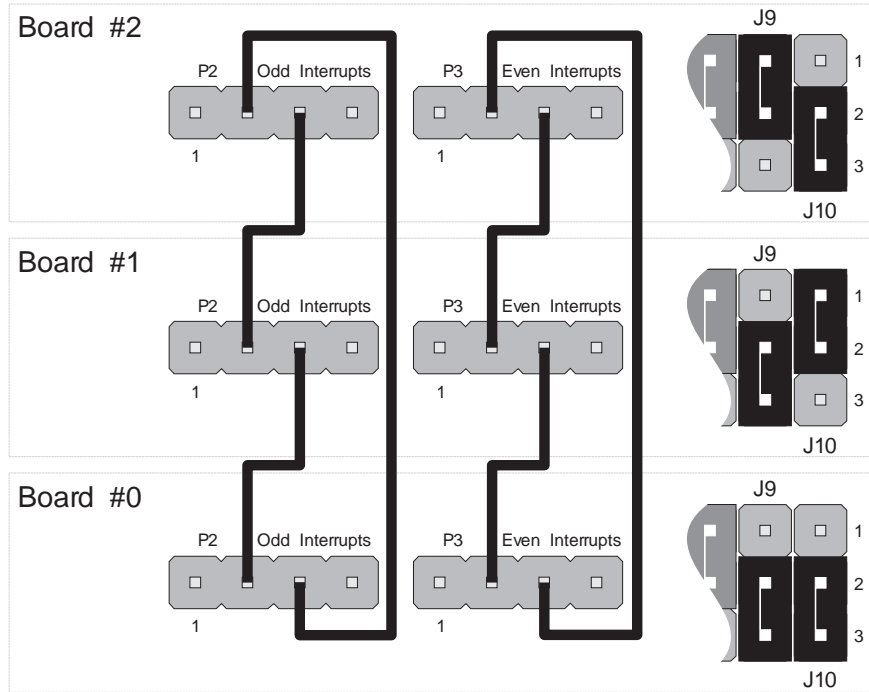
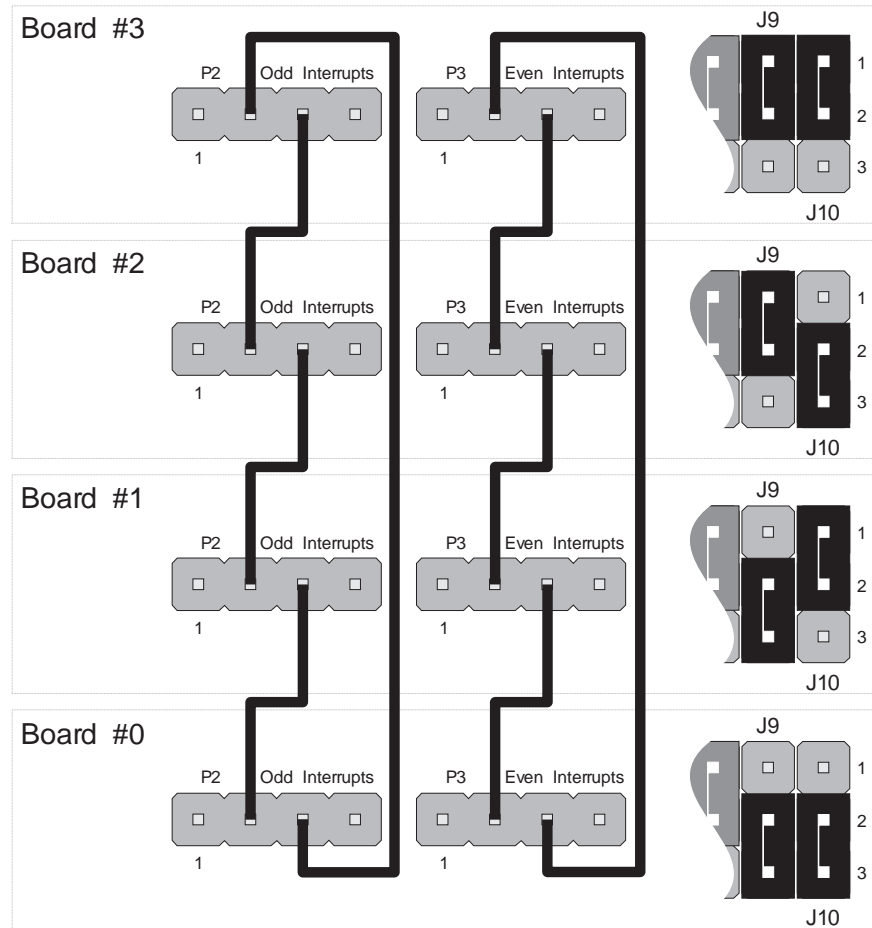

Figure 26

Four Board System (PC/4, PC/8)



# PC/16 Boards

PC/16 boards function similarly to PC/4 and PC/8 boards, with some minor differences: only two boards may be daisy chained together; since only one interrupt is supported, there is only one daisy chain connector (P3); and both boards must have the correct PALs (e.g. DOS Board 0 and DOS Board 1, or Pick Board 0 and Pick Board 1; see page 16).

**Figure 27** One Board System (PC/16)

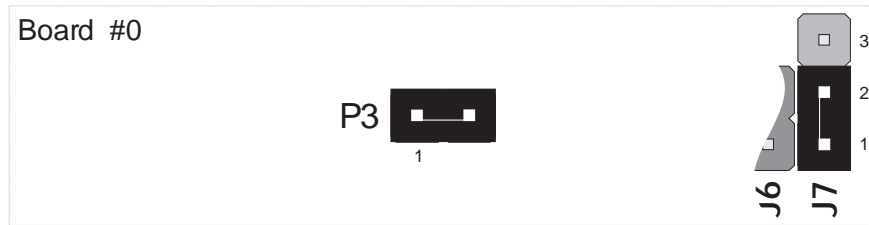

**Figure 28** Two Board System (PC/16)

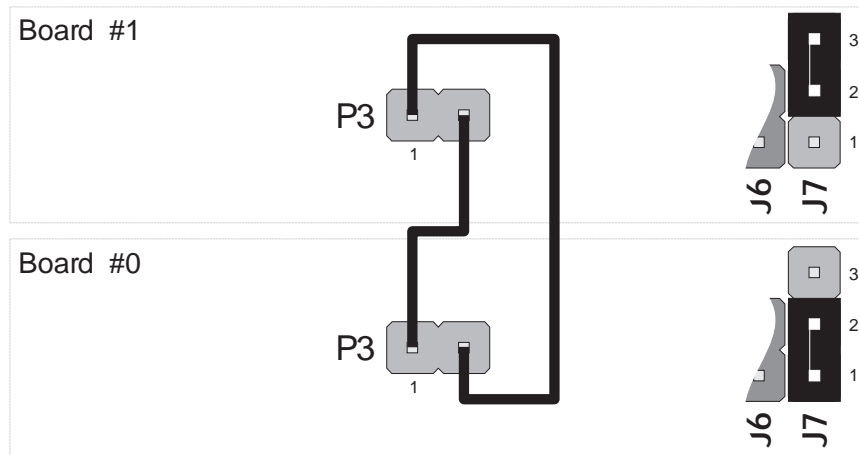

## Daisy Chain Cables

You can make your own cables as shown in the diagrams, or ready-made cables may be purchased through your DigiBoard dealer or distributor. The part numbers for the cables are:

**PC/4, PC/8:**

For Two Boards: 60000186

For Three Boards: 60000196

For Four Boards: 60000197

**PC/16:**

For Two Boards: 60000268

# Using PC/X and MC/X Boards with MS-DOS Applications

---

## PC/X Boards

MS-DOS application programs generally communicate with COM ports by directly accessing the UARTs via their I/O ports. Since these programs control the I/O hardware directly, no device driver is required. Some programs allow the user to specify the I/O port address and IRQ (Interrupt Request) line for each port, while others are able to use only the standard PC COM ports COM1 and COM2 (some applications can also use COM3 and COM4).

To use a DigiBoard PC/4 or PC/8 board with applications that allow the user to specify the I/O port address and IRQ line for each port, set the DIP switches and jumpers for addresses and IRQs that are not used by any other device in the system, then configure the application for the same addresses and IRQs (use the application's setup program or configuration screens).

To use a DigiBoard PC/4 or PC/8 board with MS-DOS applications that can reference only standard PC COM ports, the board must be set up to emulate these ports. To do this, set the DIP switches and jumpers on the board so that the first two (or four) ports on the board have the same I/O addresses and interrupts as the standard PC COM ports, as shown below.

COM Port	I/O Address	IRQ
COM1	3F8h	4
COM2	2F8h	3
COM3	3E8h	4
COM4	2E8h	3

**Important!**

When using a PC/X board to emulate standard PC COM ports, existing COM ports must be removed or completely disabled.

**Note:**

PC/16 boards cannot be configured to emulate standard PC COM ports.

To use a PC/8 or PC/4 board to emulate COM1 and COM2, set the switches and jumpers as shown below (PC/4 boards have only five banks of switches, DS1-DS5).

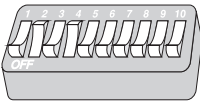
DS1: Status port set to 140h:  Select *both* IRQ3 and IRQ4 by installing jumpers on J85 and J89:

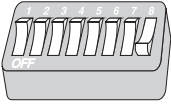
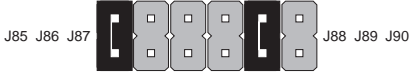
DS2: Port 1 set to 3F8h:  

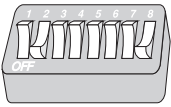
DS3: Port 2 set to 2F8h: 

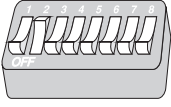
DS4: Port 3 set to 100h:  Set even interrupts for the first port, odd interrupts for the remaining ports:

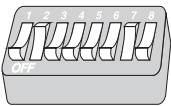
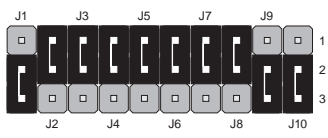
DS5: Port 4 set to 108h:  

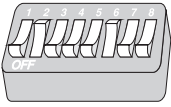
DS6: Port 5 set to 110h: 

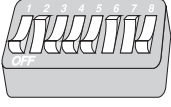
DS7: Port 6 set to 118h: 

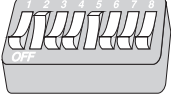
DS8: Port 7 set to 120h:  Install jumpers on both P2 and P3:

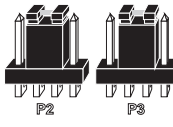
DS9: Port 8 set to 128h:  

In this configuration, the first two ports emulate COM1 (3F8h, IRQ4) and COM2 (2F8h, IRQ3). The remaining ports are set to I/O addresses 100h-128h, and use IRQ3; these ports are available to software that allows COM ports to be specified by I/O address and IRQ.

To use a PC/8 or PC/4 board to emulate COM1 through COM4, set the switches and jumpers as shown below (PC/4 boards have only five banks of switches, DS1-DS5).

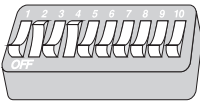
DS1: Status port set to 140h:  Select *both* IRQ3 and IRQ4 by installing jumpers on J85 and J89:

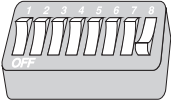
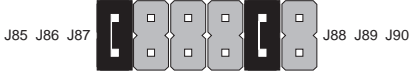
DS2: Port 1 set to 3F8h:  

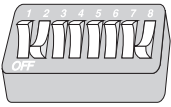
DS3: Port 2 set to 2F8h: 

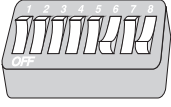
DS4: Port 3 set to 3E8h:  Set even interrupts for the first and third ports, odd interrupts for the remaining ports:

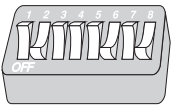
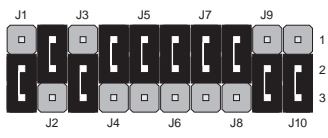
DS5: Port 4 set to 2E8h:  

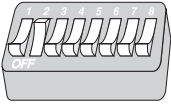
DS6: Port 5 set to 100h: 

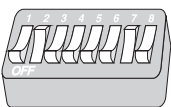
DS7: Port 6 set to 108h:  Install jumpers on both P2 and P3:

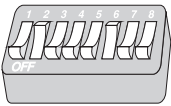
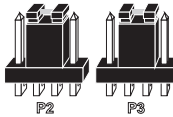
DS8: Port 7 set to 110h:  

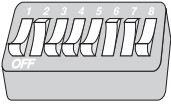
DS9: Port 8 set for 118h: 

In this configuration, the first two ports emulate COM1 (3F8h, IRQ4), COM2 (2F8h, IRQ3), COM3 (3E8h, IRQ4) and COM4 (2E8h, IRQ3). The remaining ports are set to I/O addresses 100h-118h, and use IRQ3; these ports are available to software that allows COM ports to be specified by I/O address and IRQ.



## MC/X Boards

MC/X boards have a feature that allows the first port to act like COM2. This is set during configuration with the IBM setup disk (see page 28). When Com2 Status is enabled, the first port on the board is assigned I/O address 2F8h and IRQ 3. The remainder of the ports are unaffected.

### **Important!**

If your machine has a built-in or installed COM2 port, it must be disabled or removed if Com2 Status is enabled on the MC/X board. Failure to do this will result in I/O and interrupt conflicts between the two devices.

Similarly, only one MC/X board may have Com2 Status enabled.

# Programming Information

---

Programming for PC/X and MC/X boards is very similar to programming for a standard COM port. The boards use 16C450 or 16C550 (optional) UARTs, which are directly accessible on your computer's I/O bus.

## Enabling Interrupts

When initializing the UARTs to enable interrupts, one extra step is necessary in addition to setting the appropriate bits in the UART's Interrupt Enable Register: the OUT2 bit in the Modem Control Register must also be set (to logic 1). The INTRPT output line is gated to the interrupt sequencer by the OUT2 line. If OUT2 is not set, the UART will generate an interrupt, but the board will not recognize it and it won't be passed to your computer.

## Using the Interrupt Status Register

PC/X and MC/X boards have an Interrupt Status Register (ISR) to streamline interrupt handling. When the board requests an interrupt, the software can look at the ISR to see which port caused the interrupt, instead of having to poll each UART. This can save a lot of processor time when a large number of ports is involved. The ISR also supports daisy chaining of PC/X boards so that up to 32 asynchronous serial ports can use the same interrupt (see Daisy Chaining PC/X Boards, on page 43).

### PC/4 and PC/8

The interrupt hardware on PC compatibles is edge triggered. This means that normally only one device may use a given IRQ line (if a second device raised an interrupt on the same line before the first one was serviced, no rising edge would be sensed, and the interrupt would not be detected). PC/X boards provide a method of placing up to four boards on a single IRQ line by daisy chaining the interrupts from board to board (see Daisy Chaining PC/X Boards on page 43). In this way all the boards appear as one device to the host computer.

The PC/X board has an interrupt sequencer which cycles through each of the ports on the board, looking for an active interrupt request. When it finds one, it stops cycling, activates the interrupt request line for that port and waits for the interrupt to be serviced by the host computer. Once the interrupt has been handled, the sequencer starts up again and continues in this manner until the last port is polled. At this point the sequencer's counter is reset and a token output is sent to pin 2 of either P-2 (for odd numbered interrupts) or P-3 (for even numbered interrupts). In a single-board system, this token passes through a jumper shunt and back into pin 3 of the appropriate connector, and restarts the interrupt sequencer's polling cycle. In a multi-board system, the signal passes through the daisy chain cable to pin 3 of the corresponding connector of the next board in sequence. Pin 2 of the last board is connected to pin 3 of the first board, closing the loop. In this manner, all ports of all boards are polled in each cycle.

When multiple boards will be sharing interrupt request lines, the interrupt status registers of each board **MUST** be at the same address (set by the 10-position switch bank DS-1). When reading the status port to find the particular channel generating an interrupt, the ODD interrupt is checked at the address selected on DS-1, and the EVEN interrupt is checked at that address plus 1. Thus, if the status register is addressed at 140h, the ODD interrupt status is found at address 140h and the EVEN interrupt status is found at 141h.

The status port reflects the board number in bits 3 and 4 as a binary number between 0 and 3. Bits 0, 1 and 2 contain a binary number between 0 and 7 indicating the number of the channel that needs servicing. Thus, if the status port contains 16h, or 00010110 binary, the third board (board #2) has an interrupt pending on channel 6 (or the 7th physical port—remember that the 1st board or port is number 0). If no interrupt is pending, the status port will contain FFh, or all 1s.

If more than one interrupt is pending, the status port will reflect the first one. Once that interrupt has been serviced, the next one in numerical sequence will appear in the status port. Therefore, by reading the status port until it comes up FFh, all pending interrupts will be serviced. If the interrupt service routine is exited before all interrupts have been cleared, a new interrupt will be generated as soon as interrupts have been reenabled.

## **PC/16**

PC/16 boards look like two PC/8 boards daisy chained together. Therefore the first eight ports appear to be on Board 0, and the other eight appear to be on Board 1. If two PC/16 boards are daisy chained together, the second board appears as boards 2 and 3.

## MC/X

Unlike ISA interrupt hardware (which is edge triggered), Micro Channel interrupt hardware is *level* sensitive. This allows multiple boards to share an interrupt line, which eliminates the necessity of daisy chaining boards. The MC/X Interrupt Status Register (ISR) is a 16 bit register that simultaneously reflects ALL pending interrupts for that board. The ISR is bit-mapped so that each bit represents one port on the board. Bit #0 = Port #1, etc. If no interrupts are pending, the ISR contains all zeroes. If multiple boards are using one interrupt, the software must check the ISR for each board in turn to be certain that all interrupts are serviced. When no more interrupts are pending, the ISRs will all be 00 and the IRQ line will drop.

# Specifications

---

## PC/4

### Power requirements

+5 VDC $\pm 5\%$ :	1.0 Amps max.
+12 VDC $\pm 5\%$ :	55 mA max.
-12 VDC $\pm 5\%$ :	80 mA max.

### Board dimensions

Length:	13.1 inches
Width:	0.5 inches
Height:	4.2 inches
Weight:	1.0 pounds

### Operating environment

Ambient temperature:	10° C to 55° C
Relative humidity:	5% to 90%
Air movement:	30 CFM forced
Altitude:	0 to 12,000 feet

## **PC/8**

### **Power requirements**

+5 VDC $\pm 5\%$ :	1.2 Amps max.
+12 VDC $\pm 5\%$ :	110 mA max.
-12 VDC $\pm 5\%$ :	160 mA max.

### **Board dimensions**

Length:	13.1 inches
Width:	0.5 inches
Height:	4.2 inches
Weight:	1.0 pounds

### **Operating environment**

Ambient temperature:	10° C to 55° C
Relative humidity:	5% to 90%
Air movement:	30 CFM forced
Altitude:	0 to 12,000 feet

## **PC/16**

### **Power requirements**

+5 VDC $\pm 5\%$ :	1.8 Amps max.
+12 VDC $\pm 5\%$ :	130 mA max.
-12 VDC $\pm 5\%$ :	130 mA max.

### **Board dimensions**

Length:	13.1 inches
Width:	0.5 inches
Height:	4.2 inches
Weight:	0.75 pounds

### **Operating environment**

Ambient temperature:	10° C to 55° C
Relative humidity:	5% to 90%
Air movement:	30 CFM forced
Altitude:	0 to 12,000 feet



## MC/4

### Power requirements

+5 VDC $\pm 5\%$ :	1.5 Amps max.
+12 VDC $\pm 5\%$ :	50 mA max.
-12 VDC $\pm 5\%$ :	20 mA max.

### Board dimensions

Length:	11.5 inches
Width:	0.6 inches
Height:	3.5 inches
Weight:	0.75 pounds

### Operating environment

Ambient temperature:	10° C to 55° C
Relative humidity:	5% to 90%
Air movement:	30 CFM forced
Altitude:	0 to 12,000 feet

## MC/8

### Power requirements

+5 VDC $\pm 5\%$ :	1.5 Amps max.
+12 VDC $\pm 5\%$ :	50 mA max.
-12 VDC $\pm 5\%$ :	20 mA max.

### Board dimensions

Length:	11.5 inches
Width:	0.6 inches
Height:	3.5 inches
Weight:	0.75 pounds

### Operating environment

Ambient temperature:	10° C to 55° C
Relative humidity:	5% to 90%
Air movement:	30 CFM forced
Altitude:	0 to 12,000 feet

## MC/16

### Power requirements

+5 VDC $\pm 5\%$ :	1.5 Amps max.
+12 VDC $\pm 5\%$ :	50 mA max.
-12 VDC $\pm 5\%$ :	20 mA max.

### Board dimensions

Length:	11.5 inches (16.8 inches with RJ-45 connector)
Width:	0.6 inches
Height:	3.5 inches
Weight:	0.75 pounds

### Operating environment

Ambient temperature:	10° C to 55° C
Relative humidity:	5% to 90%
Air movement:	30 CFM forced
Altitude:	0 to 12,000 feet

# Index

---

- Adapter Description Files, 25
- ADF files, 25
- ALTPIN, 33
- BBS (DigiBoard), viii
- Board ID
  - PC/16, 19
  - PC/8, PC/4, 12
- Bulletin Board, viii
- Cable configuration
  - RS-232 peripherals, 29, 30, 31, 32
- Cable leg
  - RJ-45 to DB-25, 41
  - Part numbers, 41
- Cable legs, 32
- Cables
  - Capacitance, 34
  - Environment, 34
  - Grounding, 34
  - RS-232, 34
- COM Port Emulation, 49
- Com2 Status, 28, 52
- Configuration
  - MC/X, 25
- Connector Box
  - DB-25
    - Part numbers, 37
- Connector box
  - DB-25, 37
- Connector options, 35-57
  - DB-25, 35-37
  - DB-9, 38
  - RJ-45, 39-57
    - Part numbers, 39
- Connectors
  - RJ-11
    - 4 pin, 40
    - 6 pin, 40
  - RJ-45
    - 10 pin, 40
    - 8 pin, 40
- Contention
  - IRQ, 10
- Converting RJ-45 to DB-25, 41
- Customer Assistance, ix
- Customer Service, ix
- Daisy Chain Cables, 48
- Daisy Chaining
  - PC/16, 47
  - PC/8, PC/4, 43
- DB-25 connectors, 30, 31, 32, 35-37
- Device driver support, xi
- DigiBoard BBS, viii
- DIP switches, 4
- DOC/FCC information, vii
- E-Mail addresses, ix
- FCC/DOC information, vii
- Flow control, 29, 31
  - DTR, 31
  - Hardware, 31
  - Ready/Busy, 31
  - Software, 29
- Handshaking, 29, 31
  - DTR, 31
  - Hardware, 31
  - Ready/Busy, 31
  - Software, 29
- I/O port address
  - MC/X, 26
  - PC/16, 15
  - PC/8, PC/4, 4
- Installation
  - MC/X, 22
  - PC/16, 15
  - PC/8, PC/4, 3

- Interference, RFI, vii
- Interrupt Status Register, 54
  - Switch setting, 9
- Interrupt Status Register address
  - MC/X, 26
- Interrupts
  - Enabling, 53
- IRQ
  - Contention, 10
  - Jumper settings
    - PC/8, PC/4, 11
  - MC/X, 28
  - PC/16, 18
  - PC/8, PC/4, 10
- MC/16
  - Specifications, 62
- MC/4
  - Specifications, 60
- MC/8
  - Specifications, 61
- MC/X
  - Com2 Status, 28
  - Configuration, 25
  - I/O port address, 26
  - Installation, 22
  - Interrupt Status Register
    - address, 26
  - IRQ, 28
- Modems, 32
- Modular plugs, 40
- MS-DOS Applications, 49
- Octa cable
  - DB-25, 36
    - Part numbers, 36
  - DB-9, 38
    - Part numbers, 38
- PALs
  - PC/16
    - DOS, 16
    - Pick, 17
- PC/16
  - Board ID, 19
  - Daisy Chaining, 47
  - I/O port address, 15
  - IRQ, 18
- PALs
  - DOS, 16
  - Pick, 17
  - Specifications, 59
- PC/16 installation, 15
- PC/4
  - Specifications, 57
- PC/8
  - Specifications, 58
- PC/8, PC/4
  - Board ID, 12
  - Daisy Chaining, 43
  - Dip switches, 4
  - I/O port address, 4
  - Interrupt Status Register
    - Switch setting, 9
  - IRQ, 10
  - IRQ jumper settings, 11
- PC/8, PC/4 installation, 3
- Peripherals
  - Connecting, 29
- Pin assignments
  - DB-25, vi, 35
  - DB-9, 38
- Quad cable
  - DB-25, 36
    - Part numbers, 36
  - DB-9, 38
    - Part numbers, 38
- Reference diskette, 22, 25
- Return Procedures, xii
- RJ-11 plugs, 40
- RJ-45 connectors, 30, 31, 32, 33
- RJ-45 plugs, 40
- RMA, xii
- Specifications
  - MC/16, 62
  - MC/4, 60
  - MC/8, 61
  - PC/16, 59
  - PC/4, 57
  - PC/8, 58
- Technical Support, ix
- XON/XOFF, 29



## Artisan Technology Group is your source for quality new and certified-used/pre-owned equipment

- FAST SHIPPING AND DELIVERY
- TENS OF THOUSANDS OF IN-STOCK ITEMS
- EQUIPMENT DEMOS
- HUNDREDS OF MANUFACTURERS SUPPORTED
- LEASING/MONTHLY RENTALS
- ITAR CERTIFIED SECURE ASSET SOLUTIONS

### SERVICE CENTER REPAIRS

Experienced engineers and technicians on staff at our full-service, in-house repair center

### *InstraView*<sup>SM</sup> REMOTE INSPECTION

Remotely inspect equipment before purchasing with our interactive website at [www.instraview.com](http://www.instraview.com) ↗

### WE BUY USED EQUIPMENT

Sell your excess, underutilized, and idle used equipment. We also offer credit for buy-backs and trade-ins. [www.artisanng.com/WeBuyEquipment](http://www.artisanng.com/WeBuyEquipment) ↗

### LOOKING FOR MORE INFORMATION?

Visit us on the web at [www.artisanng.com](http://www.artisanng.com) ↗ for more information on price quotations, drivers, technical specifications, manuals, and documentation

**Contact us:** (888) 88-SOURCE | [sales@artisanng.com](mailto:sales@artisanng.com) | [www.artisanng.com](http://www.artisanng.com)