



## Artisan Technology Group is your source for quality new and certified-used/pre-owned equipment

- FAST SHIPPING AND DELIVERY
- TENS OF THOUSANDS OF IN-STOCK ITEMS
- EQUIPMENT DEMOS
- HUNDREDS OF MANUFACTURERS SUPPORTED
- LEASING/MONTHLY RENTALS
- ITAR CERTIFIED SECURE ASSET SOLUTIONS

### SERVICE CENTER REPAIRS

Experienced engineers and technicians on staff at our full-service, in-house repair center

### *InstraView*<sup>SM</sup> REMOTE INSPECTION

Remotely inspect equipment before purchasing with our interactive website at [www.instraview.com](http://www.instraview.com) ↗

### WE BUY USED EQUIPMENT

Sell your excess, underutilized, and idle used equipment. We also offer credit for buy-backs and trade-ins. [www.artisanng.com/WeBuyEquipment](http://www.artisanng.com/WeBuyEquipment) ↗

### LOOKING FOR MORE INFORMATION?

Visit us on the web at [www.artisanng.com](http://www.artisanng.com) ↗ for more information on price quotations, drivers, technical specifications, manuals, and documentation

**Contact us:** (888) 88-SOURCE | [sales@artisanng.com](mailto:sales@artisanng.com) | [www.artisanng.com](http://www.artisanng.com)

# 6E233-49 SmartSwitch 6000 Interface Module User's Guide

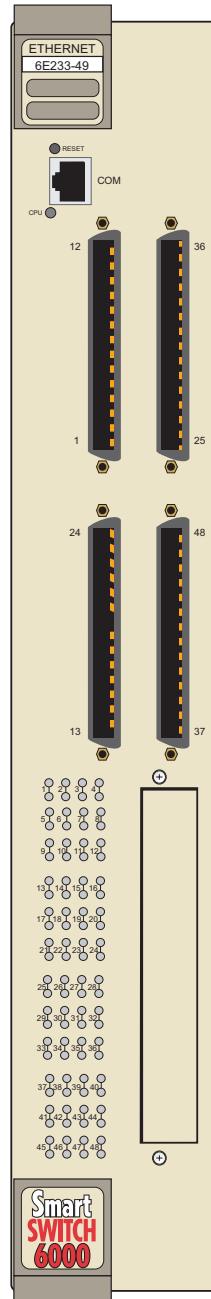

9033379

**CABLETRON**  
SYSTEMS





Only qualified personnel should perform installation procedures.

## NOTICE

Cabletron Systems reserves the right to make changes in specifications and other information contained in this document without prior notice. The reader should in all cases consult Cabletron Systems to determine whether any such changes have been made.

The hardware, firmware, or software described in this manual is subject to change without notice.

IN NO EVENT SHALL CABLETRON SYSTEMS BE LIABLE FOR ANY INCIDENTAL, INDIRECT, SPECIAL, OR CONSEQUENTIAL DAMAGES WHATSOEVER (INCLUDING BUT NOT LIMITED TO LOST PROFITS) ARISING OUT OF OR RELATED TO THIS MANUAL OR THE INFORMATION CONTAINED IN IT, EVEN IF CABLETRON SYSTEMS HAS BEEN ADVISED OF, KNOWN, OR SHOULD HAVE KNOWN, THE POSSIBILITY OF SUCH DAMAGES.

Cabletron Systems, Inc.  
35 Industrial Way  
Rochester, NH 03866-5005

© 2000 by Cabletron Systems, Inc.  
All Rights Reserved  
Printed in the United States of America

Order Number: 9033379 January 2000

**Cabletron Systems**, **QuickSET**, **SecureFast**, and **LANVIEW** are registered trademarks and **SmartSwitch** is a trademark of Cabletron Systems, Inc.

All other product names mentioned in this manual may be trademarks or registered trademarks of their respective companies.

---

## FCC NOTICE

This device complies with Part 15 of the FCC rules. Operation is subject to the following two conditions: (1) this device may not cause harmful interference, and (2) this device must accept any interference received, including interference that may cause undesired operation.

**NOTE:** This equipment has been tested and found to comply with the limits for a Class A digital device, pursuant to Part 15 of the FCC rules. These limits are designed to provide reasonable protection against harmful interference when the equipment is operated in a commercial environment. This equipment uses, generates, and can radiate radio frequency energy and if not installed in accordance with the operator's manual, may cause harmful interference to radio communications. Operation of this equipment in a residential area is likely to cause interference in which case the user will be required to correct the interference at his own expense.

**WARNING:** Changes or modifications made to this device which are not expressly approved by the party responsible for compliance could void the user's authority to operate the equipment.

## INDUSTRY CANADA NOTICE

This digital apparatus does not exceed the Class A limits for radio noise emissions from digital apparatus set out in the Radio Interference Regulations of the Canadian Department of Communications.

Le présent appareil numérique n'émet pas de bruits radioélectriques dépassant les limites applicables aux appareils numériques de la class A prescrites dans le Règlement sur le brouillage radioélectrique édicté par le ministère des Communications du Canada.

## VCCI NOTICE

This is a Class A product based on the standard of the Voluntary Control Council for Interference by Information Technology Equipment (VCCI). If this equipment is used in a domestic environment, radio disturbance may arise. When such trouble occurs, the user may be required to take corrective actions.

この装置は、情報処理装置等電波障害自主規制協議会（VCCI）の基準に基づくクラスA情報技術装置です。この装置を家庭環境で使用すると電波妨害を引き起こすことがあります。この場合には使用者が適切な対策を講ずるよう要求されることがあります。

---

## **CABLETRON SYSTEMS, INC. PROGRAM LICENSE AGREEMENT**

**IMPORTANT: THIS LICENSE APPLIES FOR USE OF PRODUCT IN THE FOLLOWING  
GEOGRAPHICAL REGIONS:**

**CANADA  
MEXICO  
CENTRAL AMERICA  
SOUTH AMERICA**

**BEFORE OPENING OR UTILIZING THE ENCLOSED PRODUCT, CAREFULLY READ  
THIS LICENSE AGREEMENT.**

This document is an agreement (“Agreement”) between You, the end user, and Cabletron Systems, Inc. (“Cabletron”) that sets forth your rights and obligations with respect to the Cabletron software program (“Program”) in the package. The Program may be contained in firmware, chips or other media. UTILIZING THE ENCLOSED PRODUCT, YOU ARE AGREEING TO BECOME BOUND BY THE TERMS OF THIS AGREEMENT, WHICH INCLUDES THE LICENSE AND THE LIMITATION OF WARRANTY AND DISCLAIMER OF LIABILITY. IF YOU DO NOT AGREE TO THE TERMS OF THIS AGREEMENT, RETURN THE UNOPENED PRODUCT TO CABLETRON OR YOUR DEALER, IF ANY, WITHIN TEN (10) DAYS FOLLOWING THE DATE OF RECEIPT FOR A FULL REFUND.

IF YOU HAVE ANY QUESTIONS ABOUT THIS AGREEMENT, CONTACT CABLETRON SYSTEMS  
+1- 603-332-9400. Attn: Legal Department.

**1. LICENSE.** You have the right to use only the one (1) copy of the Program provided in this package subject to the terms and conditions of this License Agreement.

You may not copy, reproduce or transmit any part of the Program except as permitted by the Copyright Act of the United States or as authorized in writing by Cabletron.

**2. OTHER RESTRICTIONS.** You may not reverse engineer, decompile, or disassemble the Program.

**3. APPLICABLE LAW.** This License Agreement shall be interpreted and governed under the laws and in the state and federal courts of New Hampshire. You accept the personal jurisdiction and venue of the New Hampshire courts.

**4. EXPORT REQUIREMENTS.** You understand that Cabletron and its Affiliates are subject to regulation by agencies of the U.S. Government, including the U.S. Department of Commerce, which prohibit export or diversion of certain technical products to certain countries, unless a license to export the product is obtained from the U.S. Government or an exception from obtaining such license may be relied upon by the exporting party.

If the Program is exported from the United States pursuant to the License Exception CIV under the U.S. Export Administration Regulations, You agree that You are a civil end user of the Program and agree that You will use the Program for civil end uses only and not for military purposes.

---

If the Program is exported from the United States pursuant to the License Exception TSR under the U.S. Export Administration Regulations, in addition to the restriction on transfer set forth in Sections 1 or 2 of this Agreement, You agree not to (i) reexport or release the Program, the source code for the Program or technology to a national of a country in Country Groups D:1 or E:2 (Albania, Armenia, Azerbaijan, Belarus, Bulgaria, Cambodia, Cuba, Estonia, Georgia, Iraq, Kazakhstan, Kyrgyzstan, Laos, Latvia, Libya, Lithuania, Moldova, North Korea, the People's Republic of China, Romania, Russia, Rwanda, Tajikistan, Turkmenistan, Ukraine, Uzbekistan, Vietnam, or such other countries as may be designated by the United States Government), (ii) export to Country Groups D:1 or E:2 (as defined herein) the direct product of the Program or the technology, if such foreign produced direct product is subject to national security controls as identified on the U.S. Commerce Control List, or (iii) if the direct product of the technology is a complete plant or any major component of a plant, export to Country Groups D:1 or E:2 the direct product of the plant or a major component thereof, if such foreign produced direct product is subject to national security controls as identified on the U.S. Commerce Control List or is subject to State Department controls under the U.S. Munitions List.

**5. UNITED STATES GOVERNMENT RESTRICTED RIGHTS.** The enclosed Product (i) was developed solely at private expense; (ii) contains "restricted computer software" submitted with restricted rights in accordance with section 52.227-19 (a) through (d) of the Commercial Computer Software-Restricted Rights Clause and its successors, and (iii) in all respects is proprietary data belonging to Cabletron and/or its suppliers. For Department of Defense units, the Product is considered commercial computer software in accordance with DFARS section 227.7202-3 and its successors, and use, duplication, or disclosure by the Government is subject to restrictions set forth herein.

**6. EXCLUSION OF WARRANTY.** Except as may be specifically provided by Cabletron in writing, Cabletron makes no warranty, expressed or implied, concerning the Program (including its documentation and media).

CABLETRON DISCLAIMS ALL WARRANTIES, OTHER THAN THOSE SUPPLIED TO YOU BY CABLETRON IN WRITING, EITHER EXPRESS OR IMPLIED, INCLUDING BUT NOT LIMITED TO IMPLIED WARRANTIES OF MERCHANTABILITY AND FITNESS FOR A PARTICULAR PURPOSE, WITH RESPECT TO THE PROGRAM, THE ACCOMPANYING WRITTEN MATERIALS, AND ANY ACCOMPANYING HARDWARE.

**7. NO LIABILITY FOR CONSEQUENTIAL DAMAGES.** IN NO EVENT SHALL CABLETRON OR ITS SUPPLIERS BE LIABLE FOR ANY DAMAGES WHATSOEVER (INCLUDING, WITHOUT LIMITATION, DAMAGES FOR LOSS OF BUSINESS, PROFITS, BUSINESS INTERRUPTION, LOSS OF BUSINESS INFORMATION, SPECIAL, INCIDENTAL, CONSEQUENTIAL, OR RELIANCE DAMAGES, OR OTHER LOSS) ARISING OUT OF THE USE OR INABILITY TO USE THIS CABLETRON PRODUCT, EVEN IF CABLETRON HAS BEEN ADVISED OF THE POSSIBILITY OF SUCH DAMAGES. BECAUSE SOME STATES DO NOT ALLOW THE EXCLUSION OR LIMITATION OF LIABILITY FOR CONSEQUENTIAL OR INCIDENTAL DAMAGES, OR IN THE DURATION OR LIMITATION OF IMPLIED WARRANTIES IN SOME INSTANCES, THE ABOVE LIMITATION AND EXCLUSIONS MAY NOT APPLY TO YOU.

---

## **CABLETRON SYSTEMS SALES AND SERVICE, INC. PROGRAM LICENSE AGREEMENT**

**IMPORTANT: THIS LICENSE APPLIES FOR USE OF PRODUCT IN THE UNITED STATES OF AMERICA AND BY UNITED STATES OF AMERICA GOVERNMENT END USERS.**

**BEFORE OPENING OR UTILIZING THE ENCLOSED PRODUCT, CAREFULLY READ THIS LICENSE AGREEMENT.**

This document is an agreement (“Agreement”) between You, the end user, and Cabletron Systems Sales and Service, Inc. (“Cabletron”) that sets forth your rights and obligations with respect to the Cabletron software program (“Program”) in the package. The Program may be contained in firmware, chips or other media. UTILIZING THE ENCLOSED PRODUCT, YOU ARE AGREEING TO BECOME BOUND BY THE TERMS OF THIS AGREEMENT, WHICH INCLUDES THE LICENSE AND THE LIMITATION OF WARRANTY AND DISCLAIMER OF LIABILITY. IF YOU DO NOT AGREE TO THE TERMS OF THIS AGREEMENT, RETURN THE UNOPENED PRODUCT TO CABLETRON OR YOUR DEALER, IF ANY, WITHIN TEN (10) DAYS FOLLOWING THE DATE OF RECEIPT FOR A FULL REFUND.

IF YOU HAVE ANY QUESTIONS ABOUT THIS AGREEMENT, CONTACT CABLETRON SYSTEMS +1-603-332-9400. Attn: Legal Department.

**1. LICENSE.** You have the right to use only the one (1) copy of the Program provided in this package subject to the terms and conditions of this License Agreement.

You may not copy, reproduce or transmit any part of the Program except as permitted by the Copyright Act of the United States or as authorized in writing by Cabletron.

**2. OTHER RESTRICTIONS.** You may not reverse engineer, decompile, or disassemble the Program.

**3. APPLICABLE LAW.** This License Agreement shall be interpreted and governed under the laws and in the state and federal courts of New Hampshire. You accept the personal jurisdiction and venue of the New Hampshire courts.

**4. EXPORT REQUIREMENTS.** You understand that Cabletron and its Affiliates are subject to regulation by agencies of the U.S. Government, including the U.S. Department of Commerce, which prohibit export or diversion of certain technical products to certain countries, unless a license to export the product is obtained from the U.S. Government or an exception from obtaining such license may be relied upon by the exporting party.

If the Program is exported from the United States pursuant to the License Exception CIV under the U.S. Export Administration Regulations, You agree that You are a civil end user of the Program and agree that You will use the Program for civil end uses only and not for military purposes.

If the Program is exported from the United States pursuant to the License Exception TSR under the U.S. Export Administration Regulations, in addition to the restriction on transfer set forth in Sections 1 or 2 of this Agreement, You agree not to (i) reexport or release the Program, the source code for the Program or technology to a national of a country in Country Groups D:1 or E:2 (Albania, Armenia, Azerbaijan, Belarus, Bulgaria, Cambodia, Cuba, Estonia, Georgia, Iraq, Kazakhstan, Kyrgyzstan, Laos, Latvia, Libya, Lithuania, Moldova, North Korea, the People’s Republic of China, Romania, Russia, Rwanda, Tajikistan, Turkmenistan, Ukraine, Uzbekistan, Vietnam, or such other countries as may be designated by the United States Government), (ii) export to Country Groups D:1 or E:2 (as defined herein) the direct product of the Program or the technology, if such foreign produced direct product is subject to national security controls as identified on the U.S. Commerce Control List, or (iii) if the direct product of the technology is a complete plant or any major component of a plant, export to Country Groups D:1 or E:2 the direct product of the plant or a major component thereof, if such foreign produced direct product is subject to national security controls as identified on the U.S. Commerce Control List or is subject to State Department controls under the U.S. Munitions List.

v



---

**5. UNITED STATES GOVERNMENT RESTRICTED RIGHTS.** The enclosed Product (i) was developed solely at private expense; (ii) contains “restricted computer software” submitted with restricted rights in accordance with section 52.227-19 (a) through (d) of the Commercial Computer Software-Restricted Rights Clause and its successors, and (iii) in all respects is proprietary data belonging to Cabletron and/or its suppliers. For Department of Defense units, the Product is considered commercial computer software in accordance with DFARS section 227.7202-3 and its successors, and use, duplication, or disclosure by the Government is subject to restrictions set forth herein.

**6. EXCLUSION OF WARRANTY.** Except as may be specifically provided by Cabletron in writing, Cabletron makes no warranty, expressed or implied, concerning the Program (including its documentation and media).

CABLETRON DISCLAIMS ALL WARRANTIES, OTHER THAN THOSE SUPPLIED TO YOU BY CABLETRON IN WRITING, EITHER EXPRESS OR IMPLIED, INCLUDING BUT NOT LIMITED TO IMPLIED WARRANTIES OF MERCHANTABILITY AND FITNESS FOR A PARTICULAR PURPOSE, WITH RESPECT TO THE PROGRAM, THE ACCOMPANYING WRITTEN MATERIALS, AND ANY ACCOMPANYING HARDWARE.

**7. NO LIABILITY FOR CONSEQUENTIAL DAMAGES.** IN NO EVENT SHALL CABLETRON OR ITS SUPPLIERS BE LIABLE FOR ANY DAMAGES WHATSOEVER (INCLUDING, WITHOUT LIMITATION, DAMAGES FOR LOSS OF BUSINESS, PROFITS, BUSINESS INTERRUPTION, LOSS OF BUSINESS INFORMATION, SPECIAL, INCIDENTAL, CONSEQUENTIAL, OR RELIANCE DAMAGES, OR OTHER LOSS) ARISING OUT OF THE USE OR INABILITY TO USE THIS CABLETRON PRODUCT, EVEN IF CABLETRON HAS BEEN ADVISED OF THE POSSIBILITY OF SUCH DAMAGES. BECAUSE SOME STATES DO NOT ALLOW THE EXCLUSION OR LIMITATION OF LIABILITY FOR CONSEQUENTIAL OR INCIDENTAL DAMAGES, OR IN THE DURATION OR LIMITATION OF IMPLIED WARRANTIES IN SOME INSTANCES, THE ABOVE LIMITATION AND EXCLUSIONS MAY NOT APPLY TO YOU.

---

## **CABLETRON SYSTEMS LIMITED PROGRAM LICENSE AGREEMENT**

**IMPORTANT: THIS LICENSE APPLIES FOR THE USE OF THE PRODUCT IN THE FOLLOWING  
GEOGRAPHICAL REGIONS:**

**EUROPE  
MIDDLE EAST  
AFRICA  
ASIA  
AUSTRALIA  
PACIFIC RIM**

**BEFORE OPENING OR UTILIZING THE ENCLOSED PRODUCT, CAREFULLY READ  
THIS LICENSE AGREEMENT.**

This document is an agreement (“Agreement”) between You, the end user, and Cabletron Systems Limited (“Cabletron”) that sets forth your rights and obligations with respect to the Cabletron software program (“Program”) in the package. The Program may be contained in firmware, chips or other media. UTILIZING THE ENCLOSED PRODUCT, YOU ARE AGREEING TO BECOME BOUND BY THE TERMS OF THIS AGREEMENT, WHICH INCLUDES THE LICENSE AND THE LIMITATION OF WARRANTY AND DISCLAIMER OF LIABILITY. IF YOU DO NOT AGREE TO THE TERMS OF THIS AGREEMENT, RETURN THE UNOPENED PRODUCT TO CABLETRON OR YOUR DEALER, IF ANY, WITHIN TEN (10) DAYS FOLLOWING THE DATE OF RECEIPT FOR A FULL REFUND.

IF YOU HAVE ANY QUESTIONS ABOUT THIS AGREEMENT, CONTACT CABLETRON SYSTEMS  
+1-603-332-9400. Attn: Legal Department.

**1. LICENSE.** You have the right to use only the one (1) copy of the Program provided in this package subject to the terms and conditions of this License Agreement.

You may not copy, reproduce or transmit any part of the Program except as permitted by the Copyright Act of the United States or as authorized in writing by Cabletron.

**2. OTHER RESTRICTIONS.** You may not reverse engineer, decompile, or disassemble the Program.

**3. APPLICABLE LAW.** This License Agreement shall be governed in accordance with English law. The English courts shall have exclusive jurisdiction in the event of any disputes.

**4. EXPORT REQUIREMENTS.** You understand that Cabletron and its Affiliates are subject to regulation by agencies of the U.S. Government, including the U.S. Department of Commerce, which prohibit export or diversion of certain technical products to certain countries, unless a license to export the product is obtained from the U.S. Government or an exception from obtaining such license may be relied upon by the exporting party.

If the Program is exported from the United States pursuant to the License Exception CIV under the U.S. Export Administration Regulations, You agree that You are a civil end user of the Program and agree that You will use the Program for civil end uses only and not for military purposes.

---

If the Program is exported from the United States pursuant to the License Exception TSR under the U.S. Export Administration Regulations, in addition to the restriction on transfer set forth in Sections 1 or 2 of this Agreement, You agree not to (i) reexport or release the Program, the source code for the Program or technology to a national of a country in Country Groups D:1 or E:2 (Albania, Armenia, Azerbaijan, Belarus, Bulgaria, Cambodia, Cuba, Estonia, Georgia, Iraq, Kazakhstan, Kyrgyzstan, Laos, Latvia, Libya, Lithuania, Moldova, North Korea, the People's Republic of China, Romania, Russia, Rwanda, Tajikistan, Turkmenistan, Ukraine, Uzbekistan, Vietnam, or such other countries as may be designated by the United States Government), (ii) export to Country Groups D:1 or E:2 (as defined herein) the direct product of the Program or the technology, if such foreign produced direct product is subject to national security controls as identified on the U.S. Commerce Control List, or (iii) if the direct product of the technology is a complete plant or any major component of a plant, export to Country Groups D:1 or E:2 the direct product of the plant or a major component thereof, if such foreign produced direct product is subject to national security controls as identified on the U.S. Commerce Control List or is subject to State Department controls under the U.S. Munitions List.

**5. UNITED STATES GOVERNMENT RESTRICTED RIGHTS.** The enclosed Product (i) was developed solely at private expense; (ii) contains "restricted computer software" submitted with restricted rights in accordance with section 52.227-19 (a) through (d) of the Commercial Computer Software-Restricted Rights Clause and its successors, and (iii) in all respects is proprietary data belonging to Cabletron and/or its suppliers. For Department of Defense units, the Product is considered commercial computer software in accordance with DFARS section 227.7202-3 and its successors, and use, duplication, or disclosure by the Government is subject to restrictions set forth herein.

**6. EXCLUSION OF WARRANTY.** Except as may be specifically provided by Cabletron in writing, Cabletron makes no warranty, expressed or implied, concerning the Program (including its documentation and media).

CABLETRON DISCLAIMS ALL WARRANTIES, OTHER THAN THOSE SUPPLIED TO YOU BY CABLETRON IN WRITING, EITHER EXPRESS OR IMPLIED, INCLUDING BUT NOT LIMITED TO IMPLIED WARRANTIES OF MERCHANTABILITY AND FITNESS FOR A PARTICULAR PURPOSE, WITH RESPECT TO THE PROGRAM, THE ACCOMPANYING WRITTEN MATERIALS, AND ANY ACCOMPANYING HARDWARE.

**7. NO LIABILITY FOR CONSEQUENTIAL DAMAGES.** IN NO EVENT SHALL CABLETRON OR ITS SUPPLIERS BE LIABLE FOR ANY DAMAGES WHATSOEVER (INCLUDING, WITHOUT LIMITATION, DAMAGES FOR LOSS OF BUSINESS, PROFITS, BUSINESS INTERRUPTION, LOSS OF BUSINESS INFORMATION, SPECIAL, INCIDENTAL, CONSEQUENTIAL, OR RELIANCE DAMAGES, OR OTHER LOSS) ARISING OUT OF THE USE OR INABILITY TO USE THIS CABLETRON PRODUCT, EVEN IF CABLETRON HAS BEEN ADVISED OF THE POSSIBILITY OF SUCH DAMAGES. BECAUSE SOME STATES DO NOT ALLOW THE EXCLUSION OR LIMITATION OF LIABILITY FOR CONSEQUENTIAL OR INCIDENTAL DAMAGES, OR IN THE DURATION OR LIMITATION OF IMPLIED WARRANTIES IN SOME INSTANCES, THE ABOVE LIMITATION AND EXCLUSIONS MAY NOT APPLY TO YOU.

---

## SAFETY INFORMATION

### CLASS 1 LASER TRANSCEIVERS

#### THE GPIM-01 AND GPIM-09 GIGABIT ETHERNET MODULES USE CLASS 1 LASER TRANSCEIVERS.

#### READ THE FOLLOWING SAFETY INFORMATION BEFORE INSTALLING OR OPERATING THESE MODULES.

The Class 1 laser transceivers use an optical feedback loop to maintain Class 1 operation limits. This control loop eliminates the need for maintenance checks or adjustments. The output is factory set, and does not allow any user adjustment. Class 1 Laser transceivers comply with the following safety standards:

- 21 CFR 1040.10 and 1040.11 U.S. Department of Health and Human Services (FDA).
- IEC Publication 825 (International Electrotechnical Commission).
- CENELEC EN 60825 (European Committee for Electrotechnical Standardization).

When operating within their performance limitations, laser transceiver output meets the Class 1 accessible emission limit of all three standards. Class 1 levels of laser radiation are not considered hazardous.

## SAFETY INFORMATION

### CLASS 1 LASER TRANSCEIVERS

#### LASER RADIATION AND CONNECTORS

When the connector is in place, all laser radiation remains within the fiber. The maximum amount of radiant power exiting the fiber (under normal conditions) is -12.6 dBm or  $55 \times 10^{-6}$  watts.

Removing the optical connector from the transceiver allows laser radiation to emit directly from the optical port. The maximum radiance from the optical port (under worst case conditions) is  $0.8 \text{ W cm}^{-2}$  or  $8 \times 10^3 \text{ W m}^2 \text{ sr}^{-1}$ .

**Do not use optical instruments to view the laser output. The use of optical instruments to view laser output increases eye hazard. When viewing the output optical port, power must be removed from the network adapter.**

---

## DECLARATION OF CONFORMITY

Application of Council Directive(s): **89/336/EEC**  
**73/23/EEC**

Manufacturer's Name: **Cabletron Systems, Inc.**

Manufacturer's Address: **35 Industrial Way**  
**PO Box 5005**  
**Rochester, NH 03867**

European Representative Name: **Mr. J. Solari**

European Representative Address: **Cabletron Systems Limited**  
**Nexus House, Newbury Business Park**  
**London Road, Newbury**  
**Berkshire RG14 2PZ, England**

Conformance to Directive(s)/Product Standards: **EC Directive 89/336/EEC**  
**EC Directive 73/23/EEC**  
**EN 55022**  
**EN 50082-1**  
**EN 60950**

Equipment Type/Environment: **Networking Equipment, for use in a Commercial**  
**or Light Industrial Environment.**

We the undersigned, hereby declare, under our sole responsibility, that the equipment packaged with this notice conforms to the above directives.

Manufacturer

Mr. Ronald Fotino

Full Name

Compliance Engineering Manager

Title

Rochester, NH, USA

Location

Legal Representative in Europe

Mr. J. Solari

Full Name

Managing Director - E.M.E.A.

Title

Newbury, Berkshire, England

Location

**x**

---

# Contents

Figures.....	xiii
Tables.....	xiv

## ABOUT THIS GUIDE

Using This Guide.....	xv
Structure of This Guide.....	xvi
Related Documents.....	xvii

# 1

## INTRODUCTION

1.1	Overview.....	1-1
1.1.1	Connectivity.....	1-3
1.1.2	Auto-Negotiation.....	1-3
1.1.3	Runtime IP Address Discovery.....	1-3
1.1.4	Full Duplex Switched Ethernet.....	1-4
1.1.5	SmartTrunk.....	1-4
1.1.6	Remote Monitoring (RMON).....	1-4
1.1.7	Broadcast Suppression.....	1-4
1.1.8	Port/VLAN Redirect Functions.....	1-5
1.1.9	Rate Limiting.....	1-5
1.1.10	GARP Switch Operation.....	1-6
1.1.11	802.1 Port Priority.....	1-6
1.1.12	Management.....	1-6
1.1.13	Switching Options.....	1-6
1.1.14	Distributed Chassis Management.....	1-7
1.1.15	Optional HSIMs.....	1-7
1.1.16	Standards Compatibility.....	1-7
1.1.17	LANVIEW Diagnostic LEDs.....	1-7
1.1.18	Year 2000 Compliance.....	1-7
1.2	Getting Help.....	1-8

---

## 2

### NETWORK REQUIREMENTS

2.1	SmartTrunk.....	2-1
2.2	10BASE-T Network.....	2-1

## 3

### INSTALLATION

3.1	Required Tools.....	3-1
3.2	Unpacking the 6E233-49 SmartSwitch .....	3-1
3.3	Installing Options.....	3-2
3.4	Installing the 6E233-49 SmartSwitch into the 6C105 Chassis .....	3-2
3.5	Connecting to the Network.....	3-5
3.6	Completing the Installation.....	3-8

## 4

### TROUBLESHOOTING

4.1	Using LANVIEW.....	4-1
4.2	Troubleshooting Checklist.....	4-5
4.3	Using the RESET Button.....	4-10

## A

### SPECIFICATIONS

A.1	Module Specifications .....	A-1
A.2	Physical Properties .....	A-1
A.3	Environmental Requirements.....	A-1
A.4	Input/Output Ports .....	A-2
A.5	COM Port Pinout Assignments .....	A-2
A.6	Regulatory Compliance.....	A-2

## B

### OPTIONAL INSTALLATIONS AND MODE SWITCH BANK SETTINGS

B.1	Required Tools.....	B-1
B.2	Setting the Mode Switches.....	B-1
B.3	SIMM Upgrade .....	B-3
	B.3.1 Locating SIMMs .....	B-3
	B.3.2 Installing the DRAM SIMM.....	B-4
B.4	Installing Optional High Speed Interface Modules .....	B-5

## INDEX

---

## Figures

Figure		Page
1-1	The 6E233-49 SmartSwitch .....	1-2
3-1	Installing an Interface Module .....	3-4
3-2	Straight Cable Connection .....	3-6
3-3	Connection Using the RJ21 Angle Adapter .....	3-7
4-1	LANVIEW LEDs .....	4-2
4-2	RESET Button .....	4-10
B-1	Module Mode Switch Location/Component Layout .....	B-2
B-2	SIMM Slot Locations .....	B-3
B-3	Installing the DRAM.....	B-4
B-4	HSIM Connector Location .....	B-5



---

# Tables

Table		Page
3-1	Contents of 6E233-49 SmartSwitch Carton.....	3-2
4-1	LANVIEW LEDs CPU, Receive, and Transmit Status.....	4-3
4-2	Fault Identification .....	4-5
4-3	Power System Troubleshooting.....	4-6
4-4	Firmware Troubleshooting.....	4-7
4-5	Management System Troubleshooting.....	4-8
4-6	Device Setup Troubleshooting .....	4-9

---

## About This Guide

Welcome to the Cabletron Systems **6E233-49 SmartSwitch 6000 Interface Module User's Guide**. This guide describes the SmartSwitch module and provides information concerning network requirements, installation, and troubleshooting. For information about how to use Local Management to configure and manage the SmartSwitch series, refer to the *SmartSwitch Series 6H202, 6H203, 6H252, 6H253, 6H258, 6H259, 6H262, 6E233, and 6E253 Local Management User's Guide*.

---

### Important Notice

Depending on the firmware version used in the device, some features described in this document may not be supported. Refer to the Release Notes shipped with the 6E233-49 to determine which features are supported.

---

### USING THIS GUIDE

Read through this guide completely to understand the 6E233-49 SmartSwitch module's features and capabilities.

A general working knowledge of IEEE 802.3 type data communications networks and their physical layer components is helpful when using these devices.



In this document, the SmartSwitch module may also be referred to as "SmartSwitch" or "module".

## STRUCTURE OF THIS GUIDE

This guide is organized as follows:

**Chapter 1, Introduction**, outlines the contents of this manual, describes the features of the SmartSwitch module, and provides instructions for getting additional help. This chapter also includes a list of technology and user guides that may help the user to set up and manage the SmartSwitch module.

**Chapter 2, Network Requirements**, outlines the network requirements that must be met before installing the SmartSwitch module into the 6C105 SmartSwitch 6000 chassis.

**Chapter 3, Installation**, provides instructions on how to install the module in the chassis and connect segments to the device.

**Chapter 4, Troubleshooting**, details the SmartSwitch module LANVIEW LEDs that enable quick diagnosis of network/operational problems.

**Appendix A, Specifications**, contains information on functionality and operating specifications, connector pinouts, environmental requirements, and physical properties.

**Appendix B, Optional Installations and Mode Switch Bank Settings**, describes how to set the Mode Switches, and gives information on upgrading the SmartSwitch module.

## RELATED DOCUMENTS

- *SmartSwitch Series 6H202, 6H203, 6H252, 6H253, 6H258, 6H259, 6H262, 6E233, and 6E253 Local Management User's Guide*
- *6C105 SmartSwitch 6000 Overview and Setup Guide*
- *Ethernet Technology Guide*
- *Cabling Guide*
- *802.1Q VLAN User's Guide*
- *SmartTrunk User's Guide*

The following manuals, as applicable, may help the user to set up and manage the SmartSwitch:

- *HSIM-A6DP User's Guide*
- *HSIM-F6 User's Guide*
- *HSIM-FE6 User's Guide*
- *HSIM-W6 User's Guide*
- *HSIM-W84 User's Guide*
- *HSIM-W87 User's Guide*
- *HSIM-G01/G09 User's Guide*
- *VHSIM-G6 User's Guide*
- *VHSIM-A6DP User's Guide*
- *WAN Series Local Management User's Guide*
- *VHSIM-A6DP User's Guide*

The *HSIM-W6 Installation Guide*, the *HSIM-W84 Installation Guide*, and the *WAN Series Local Management User's Guide* are included on the QuickSET CD-ROM and, along with the other manuals referenced above, can be obtained on the World Wide Web in Adobe Acrobat Portable Document Format (PDF) at the following site: <http://www.cabletron.com/>



All documentation for Cabletron Systems SecureFast VLAN Manager software can be found on the VLAN Manager CD-ROM.

## DOCUMENT CONVENTIONS

The following conventions are used throughout this document:

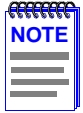

**Note** symbol. Calls the reader's attention to any item of information that may be of special importance.



**Tip** symbol. Conveys helpful hints concerning procedures or actions.



**Caution** symbol. Contains information essential to avoid damage to the equipment.



**Electrical Hazard Warning** symbol. Warns against an action that could result in personal injury or death due to an electrical hazard.

---

# Introduction

This chapter introduces the 6E233-49 SmartSwitch 6000 device and provides information about how to obtain additional support from Cabletron Systems.

---

## Important Notice

Depending on the firmware version used in the SmartSwitch, some features described in this document may not be supported. Refer to the Release Notes shipped with the SmartSwitch to determine which features are supported.

---

## 1.1 OVERVIEW

The 6E233-49 SmartSwitch, shown in [Figure 1-1](#), is an Ethernet interface module for the Cabletron Systems 6C105 chassis. The 6E233-49 has 48 switched ports via four RJ21 connectors, and 1 slot for an optional High Speed Interface Module (HSIM).

The 6E233-49 SmartSwitch can be used to connect individual high-bandwidth user devices, such as workstations, or to provide a central switching point for multiple 10 Mbps Ethernet segments. The optional HSIMs provide one or more high speed uplinks to networking technologies such as Gigabit Ethernet, Fast Ethernet, Fiber Distributed Data Interface (FDDI), Wide Area Network (WAN) and Asynchronous Transfer Mode (ATM). The ESX-1620 is not capable of supporting VHSIMs.

The 6E233-49 SmartSwitch ports can be configured to control frame traffic several ways, including prioritizing traffic flow according to protocol type. The 6E233-49 SmartSwitch can also be configured to establish Virtual Local Area Networks (VLANs) and control the flow of frames associated with each VLAN according to priority and Ether type. Detailed information about VLANs is provided in the Cabletron Systems *802.1Q VLAN User's Guide*.

The following sections describe the features of the 6E233-49 SmartSwitch and concludes with information on how to obtain assistance from Cabletron Systems.

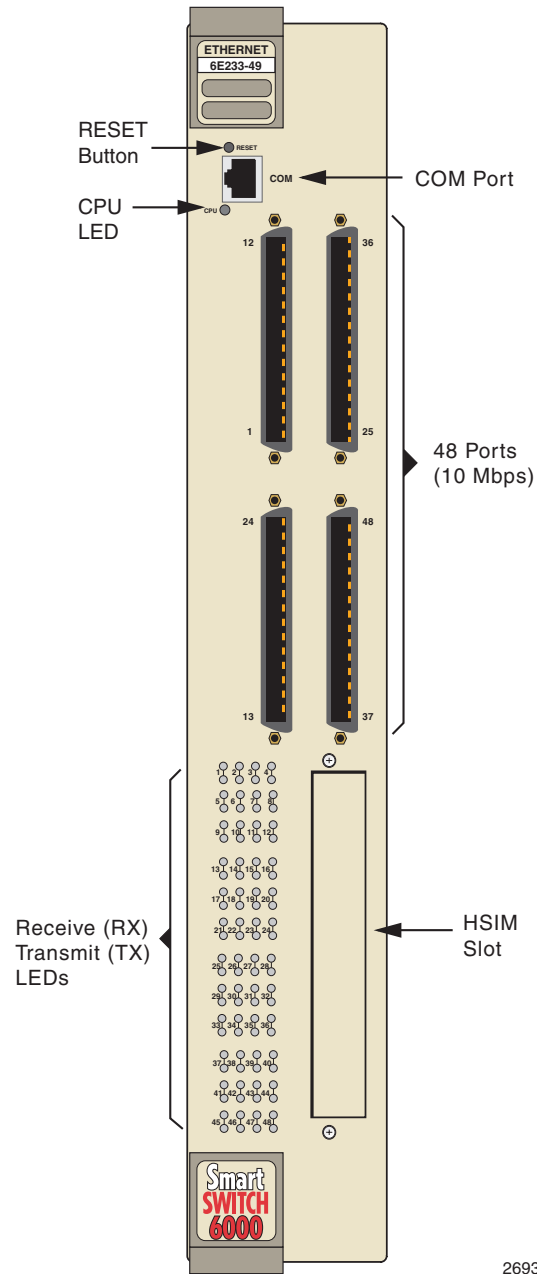

2693\_01

**Figure 1-1 The 6E233-49 SmartSwitch**

### 1.1.1 Connectivity

The 6E233-49 SmartSwitch connects to Ethernet networks or workstations through the four RJ21 connectors on the front panel. These ports support Unshielded Twisted Pair (UTP) cables with an impedance between 85 and 111 ohms at lengths up to 100 meters. These ports are IEEE 802.3u 10BASE-TX compliant.

The 6E233-49 has a slot for an optional HSIM to provide additional connectivity to various networking technologies.

### 1.1.2 Auto-Negotiation

The front panel ports on the 6E233-49 SmartSwitch module have the ability to auto-negotiate the type of connection required to provide a link to another device. During Auto-Negotiation, two devices automatically exchange information “telling” each other what their operating capabilities are. The Auto-Negotiation feature targets the maximum capabilities that can be reached between the two devices.

When Auto-Negotiation is supported at both ends of a link, the two devices dynamically adjust to full or half duplex operation based on the maximum capability that can be reached between the two devices. If the device connected to the 6E233-49 SmartSwitch cannot auto-negotiate, the 6E233-49 SmartSwitch interface operates according to the capabilities of the other device.

### 1.1.3 Runtime IP Address Discovery

This feature enables the module to automatically accept an IP address from a Boot Strap Protocol (BootP) server on the network into NVRAM without requiring a user to enter an IP address through Local Management.

When the module is connected to the network and powered up, Runtime IP Address Discovery (RAD) checks the module for an IP address. If one has not yet been assigned (module and 6C105 chassis IP address set to 0.0.0.0), RAD checks to see if any of the module interfaces have a link. If so, RAD sends out Reverse Address Resolution Protocol (RARP) and BootP requests to obtain an IP address from a RARP or BootP server on the network.

The RAD requests start out at an interval of one second. The interval then doubles after every transmission until an interval of 300 seconds is reached. At this point, the interval remains at 300 seconds. The RAD requests continue until an IP address is received from a RARP or BootP server, or an IP address is entered using Local Management.



The module will reboot after RAD is successful.



### 1.1.4 Full Duplex Switched Ethernet

Each switched Ethernet port on the 6E233-49 SmartSwitch can be configured to operate in Full Duplex Switched Ethernet (FDSE) mode. FDSE allows each port to provide up to 20 Mbps of bandwidth.

### 1.1.5 SmartTrunk

SmartTrunk, also referred to as SmartTrunking, is Cabletron Systems' terminology for load balancing or load sharing. SmartTrunk technology provides an easy-to-implement mechanism to group, or aggregate, multiple links of any technology together to scale the backbone bandwidth beyond the limitations of a single link. All links are user-configurable so administrators can scale the backbone bandwidth by adding SmartTrunk links. The benefits of SmartTrunking include the following:

- All purchased bandwidth is used.
- Distributed, resilient links increase reliability and performance.
- Multiple technologies are supported within a single trunk for maximum flexibility.

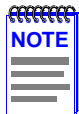

For information on SmartTrunk configuration, refer to the Cabletron Systems *SmartTrunk User's Guide*.

### 1.1.6 Remote Monitoring (RMON)

The 6E233-49 SmartSwitch supports all nine Ethernet RMON groups, which include Statistics, Alarms, Events and History. These groups are enabled on all ports by default.

Cabletron Systems RMON Actions is a vendor-specific extension of RMON and provides the ability to set an "Action" on any SNMP MIB variable. The Action can be triggered by any RMON Event and/or Alarm. An example of an Action would be to turn off a MIB-2 interface if a broadcast threshold is crossed.

### 1.1.7 Broadcast Suppression

Broadcast Suppression enables a user to set a desired limit of receive broadcast frames per port/per second to be forwarded out the other ports on the module up to the set limit. Any broadcast frames above this specified limit are dropped. In the event that broadcast frames are being suppressed, multicast and unicast frames continue to be switched.

### 1.1.8 Port/VLAN Redirect Functions

The port redirect function, also referred to as “Port Mirroring,” is a troubleshooting tool used to map traffic from a single source port to a single destination port within the device. This feature allows frames, including those with errors to be copied and sent to an analyzer or RMON probe. The analyzer or RMON probe will see the data as if it were directly connected to the LAN segment of the source port.

The VLAN redirect function is similar to the port redirect function except that the frames received by the device are redirected to a designated destination port according to the VLAN classification of the frames received. The VLAN redirect function does not support redirecting errors, and is only supported when the device is operating as an 802.1Q switch. Multiple VLANs can be directed to the same ports.

### 1.1.9 Rate Limiting

The Rate Limiting feature enables the SmartSwitch device to have control of traffic rates on a per-port, per-priority basis. The network administrator can configure a rate limit (from 100 kbps to 1 Gbps) for a given port with an associated list of IEEE 802.1p priorities (which can include one, some, or all of the eight priority levels defined in 802.1p). Each rate limit is specified as an inbound or an outbound limit. The combined rate of all traffic on the port that matches the listed priorities cannot exceed the programmed limit. If the rate exceeds the defined limit, frames are dropped until the rate falls below the limit.

Administrators can configure up to four rate limit rules per port; however, each rule must not include conflicting 802.1p priority values. In order to control traffic inbound and outbound on the same port, two rate limit rules must be configured (one inbound and one outbound). Since the rate limiting operation occurs after the processing of the multi-layer classification rules, the two features can be combined to provide application-aware rate limiting.



This traffic rate function is not supported on ports configured as SmartTrunk ports.

For more information about the application of the Rate Limiting function, refer to the *Local Management User's Guide*.

### 1.1.10 GARP Switch Operation

Some or all ports on the switch may be activated to operate under the Generic Attribute Registration Protocol (GARP) applications, GARP VLAN Registration Protocol (GVRP) and/or GARP Multicast Registration Protocol (GMRP).

GARP is a protocol, or set of rules, that outlines a mechanism for propagating the port state and/or user information throughout a bridged LAN to keep track of users and VLANs on the network fabric. MAC bridges and end users alike can take part in the registration and de-registration of GARP attributes such as VLAN and multicast group membership. For more details on how GVRP and GMRP handle frames under GARP, and how to configure the switch ports to take advantage of this operation, refer to the *SmartSwitch Series 6H202, 6H203, 6H252, 6H253, 6H258, 6H259, 6H262, 6E233, and 6E253 Local Management User's Guide*.

### 1.1.11 802.1 Port Priority

IEEE 802.1 port priority is incorporated in the IEEE 802.1D standard. It is used to assign a default priority to the frames received without priority information in their tag header, to map prioritized frames to the appropriate transmit queues, and to prioritize frames according to protocol type.

### 1.1.12 Management

Management of the 6E233-49 SmartSwitch module and 6C105 chassis is accomplished using Local Management application or remote SNMP management stations. Local Management is accessible through the RS232 COM port on the front panel using a local VT100 terminal, or a remote VT100 terminal via a modem connection, and in-band via a Telnet connection. In-band remote management is possible through any SNMP compliant Network Management Software.

Local Management, as described in this user's guide, provides the ability to manage the 6E233-49. Local Management information for non-Ethernet HSIMs or VHSIMs is included in their respective user's guide. For details on how to get manuals, refer to the [Related Manuals](#) section in the [About This Guide](#) section.

### 1.1.13 Switching Options

The 6E233-49 SmartSwitch provides 802.1Q switching or SecureFast Switching Virtual Network Services between all of the front panel interfaces including any optional HSIMs. In the 802.1Q mode (the default mode of operation), the switch functions as an 802.1D switch until VLANs are configured. SecureFast switching and IEEE 802.1Q switching allow migration to Virtual Network technologies without requiring the replacement of existing equipment.

### 1.1.14 Distributed Chassis Management

From a management perspective, the 6C105 SmartSwitch 6000 chassis can be viewed as a single entity with a single IP address. Its systems management functions are distributed to all modules. The chassis can be managed using a single IP address, or the modules can be managed separately by individual IP addresses. When using a single IP address, system wide settings can be done from the chassis menu in Local Management, while module settings are done by selecting the specific module to be modified and changing the settings for that module.

### 1.1.15 Optional HSIMs

The 6E233-49 provides a slot for an optional High Speed Interface Module (HSIM) for additional connectivity to various networking technologies. Any exceptions to the HSIMs that operate in the 6E233-49 SmartSwitch are listed in the Release Notes. The 6E233-49 is not capable of supporting VHSIMs.

### 1.1.16 Standards Compatibility

The 6E233-49 SmartSwitch is fully compliant with the IEEE 802.3, 802.3x, 802.3u, 802.1D, and especially 802.1Q standards. The 6E233-49 SmartSwitch provides IEEE 802.1D Spanning Tree Algorithm (STA) support to enhance the overall reliability of the network and protect against “loop” conditions. The 6E233-49 SmartSwitch supports a wide variety of industry standard MIBs including RFC 1213 (MIB II), RFC 1757 (RMON), RFC 1493 (Bridge MIB), RFC 1354 (FIB MIB) and RFC 1190 (Path MTU Discovery). A full suite of Cabletron Systems Enterprise MIBs provide a wide array of statistical information to enhance troubleshooting. For information on how to extract and compile individual MIBs, contact Cabletron Systems.

### 1.1.17 LANVIEW Diagnostic LEDs

LANVIEW diagnostic LEDs serve as an important troubleshooting aid by providing an easy way to observe the status of individual ports and overall network operations. [Chapter 4](#) provides details about the 6E233-49 SmartSwitch LANVIEW LEDs.

### 1.1.18 Year 2000 Compliance

The 6E233-49 SmartSwitch module and 6C105 chassis have an internal clock that can maintain the time and date beyond the year 1999.

## 1.2 GETTING HELP

For additional support related to this device or document, contact Cabletron Systems using one of the following methods:

World Wide Web	<a href="http://www.cabletron.com/">http://www.cabletron.com/</a>
Phone	(603) 332-9400
Internet mail	<a href="mailto:support@cabletron.com">support@cabletron.com</a>
FTP	<a href="ftp://ftp.cabletron.com/">ftp://ftp.cabletron.com/</a>
Login	<i>anonymous</i>
Password	<i>your email address</i>

---

To send comments or suggestions concerning this document, contact the Cabletron Systems Technical Writing Department via the following email address: **TechWriting@cabletron.com**  
*Make sure to include the document Part Number in the email message.*

---

### **Before calling Cabletron Systems, have the following information ready:**

- Your Cabletron Systems service contract number
- A description of the failure
- A description of any action(s) already taken to resolve the problem (e.g., changing mode switches, rebooting the unit, etc.)
- The serial and revision numbers of all involved Cabletron Systems products in the network
- A description of your network environment (layout, cable type, etc.)
- Network load and frame size at the time of trouble (if known)
- The device history (i.e., have you returned the device before, is this a recurring problem, etc.)
- Any previous Return Material Authorization (RMA) numbers

---

## Network Requirements

Before installing the 6E233-49 SmartSwitch, review the requirements and specifications referred to in this chapter concerning the SmartTrunk feature ([Section 2.1](#)) and the 10BASE-T Twisted Pair Network ([Section 2.2](#)).

The network installation must meet the guidelines to ensure satisfactory performance of this equipment. Failure to follow the guidelines may produce poor network performance.

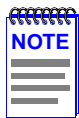

The Cabletron Systems *SmartTrunk User's Guide* and *Cabling Guide* referred to in the following sections can be found on the Cabletron Systems World Wide Web site: <http://www.cabletron.com/>

### 2.1 SmartTrunk

To connect the 6E233-49 SmartSwitch to a network so it can take advantage of the SmartTrunk feature, there are certain rules concerning port connections and configurations that must be followed for proper operation. For more information on SmartTrunk, refer to the Cabletron Systems *SmartTrunk User's Guide*.

### 2.2 10BASE-T NETWORK

When connecting a 10BASE-T segment to any of the 6E233-49 SmartSwitch ports, ensure that the network meets the Ethernet network requirements of the IEEE 802.3 standard for 10BASE-T. Refer to the Cabletron Systems *Cabling Guide* for details.





Only qualified personnel should install the 6E233-49 SmartSwitch.

---

### Important Notice

Depending on the firmware version used in the SmartSwitch, some features described in this document may not be supported. Refer to the Release Notes shipped with the SmartSwitch to determine which features are supported.

---

This chapter provides the instructions required to install the 6E233-49 SmartSwitch. Follow the order of the sections listed below to ensure a proper installation:

- Required tools ([Section 3.1](#))
- Unpacking the 6E233-49 SmartSwitch ([Section 3.2](#))
- Installing Options ([Section 3.3](#))
- Installing the 6E233-49 SmartSwitch in the 6C105 chassis ([Section 3.4](#))
- Connecting to the network ([Section 3.5](#))

## 3.1 REQUIRED TOOLS

A Phillips screwdriver is required to install the HSIMs in the 6E233-49.

## 3.2 UNPACKING THE 6E233-49 SMARTSWITCH

1. Open the box and remove the packing material protecting the module.
2. Verify the contents of the carton as listed in [Table 3-1](#).



**Table 3-1 Contents of 6E233-49 SmartSwitch Carton**

Item	Quantity
2H252-25	1
Antistatic Wrist Strap	1
RJ21 Adapter/Extender	4
Release Notes	1
Manual Accessory Kit	1

### 3.3 INSTALLING OPTIONS

If the 6E233-49 SmartSwitch is to be installed with an optional HSIM, refer to the installation instructions shipped with the HSIM. The HSIM must be installed before the 6E233-49 is installed in the chassis.

### 3.4 INSTALLING THE 6E233-49 SMARTSWITCH INTO THE 6C105 CHASSIS



Failure to observe static safety precautions could cause damage to the 6E233-49 SmartSwitch. Follow static safety handling rules and properly wear the antistatic wrist strap provided with the 6C105 chassis.

The 6E233-49 SmartSwitch can be installed in any of the 5 slots that are available in the 6C105. To install a module, proceed as follows:

1. Remove the blank panel covering the slot in which the module will be installed. All other slots must remain covered to ensure proper air flow and cooling. (Save the blank plate in the event you need to remove the module.)
2. Carefully remove the module from the shipping box. (Save the box and packing materials in the event the module must be reshipped.)



Do not cut the non-conductive bag to remove the module. Damage could result from sharp objects contacting the board or components.

#### 3-2 Installation

3. Locate the antistatic wrist strap shipped with the 6C105 chassis. Attach the antistatic wrist strap to your wrist and plug the cable from the antistatic wrist strap into the ESD grounding receptacle at the upper right corner of the 6C105.
4. Remove the module from the plastic bag. (Save the bag in the event the module must be reshipped.) Observe all precautions to prevent damage from Electrostatic Discharge (ESD).
5. Examine the module for damage. If any damage exists, DO NOT install the module. Immediately contact Cabletron Systems. Refer to [Section 1.2](#).



To prevent damaging the backplane connectors in the following step, take care that the module slides in straight and properly engages the backplane connectors.

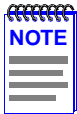

In the following step, ensure that the top plastic locking tab lines up with the desired slot number located on the front panel of the chassis. Refer to [Figure 3-1](#).

6. Locate the slot guides that line up with the number of the slot in which the module will be installed. Install the module in the chassis by aligning the module circuit card between the upper and lower metal rail guides of the desired slot, sliding it into the chassis, and locking down the top and bottom plastic locking tabs, as shown in [Figure 3-1](#). Take care that the module slides in straight and properly engages the backplane connectors.
7. If the chassis in which the module is installed was powered down for the installation, turn it back on. Check to see that the CPU LED settles at solid green after a few minutes. If the LED does not turn solid green, refer to [Chapter 4](#) for details.

Installing the 6E233-49 SmartSwitch into the 6C105 Chassis

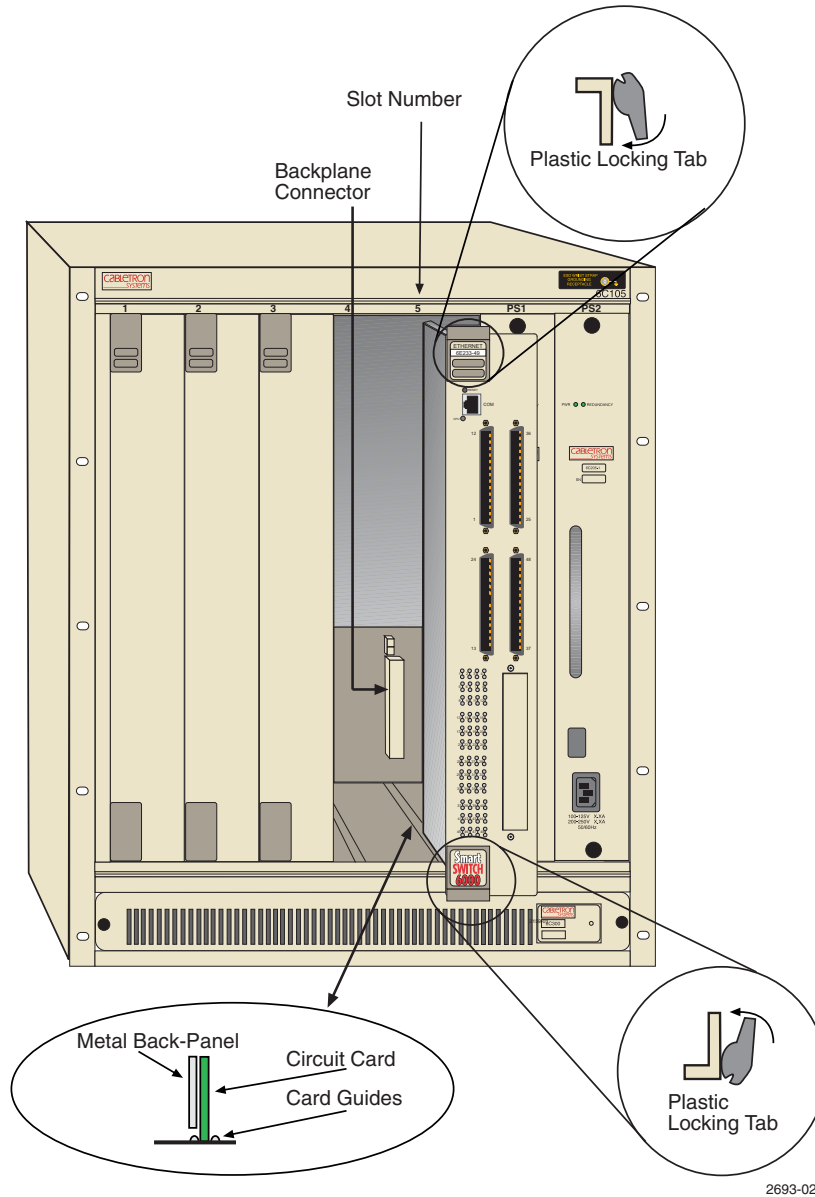

2693-02

**Figure 3-1** Installing an Interface Module

**3-4** Installation

### 3.5 CONNECTING TO THE NETWORK

This section provides the procedures for connecting unshielded twisted pair (UTP) segments to the modules.

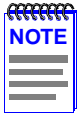

If the device is being installed in a network using SmartTrunking, there are rules concerning the cable connections and port configurations that must be followed for SmartTrunking to operate properly. Before connecting the cables, refer to the Cabletron Systems *SmartTrunk User's Guide* for the configuration information.

To make connections to an optional HSIM installed in the HSIM slot of a SmartSwitch, refer to the instructions shipped with that device.

When facing the front panel of a 6E233-49 SmartSwitch, the top-left RJ21 is the connector for 10BASE-T ports 1 through 12; bottom left, ports 13 through 24; top-right, ports 25 through 36; and bottom-right, ports 37 through 48. All 48 ports have internal crossovers.

To connect an RJ21, proceed as follows:

1. Ensure that the device connected to the other end of the segment is powered ON.
2. If using an RJ21 straight connector, plug it into the appropriate RJ21 port as shown in [Figure 3-2](#), or if using the RJ21 right-angled adapter supplied with the device, insert it as shown in [Figure 3-3](#). The RJ21 right-angled adapter enables the cables to be dressed closely along the front of the device.

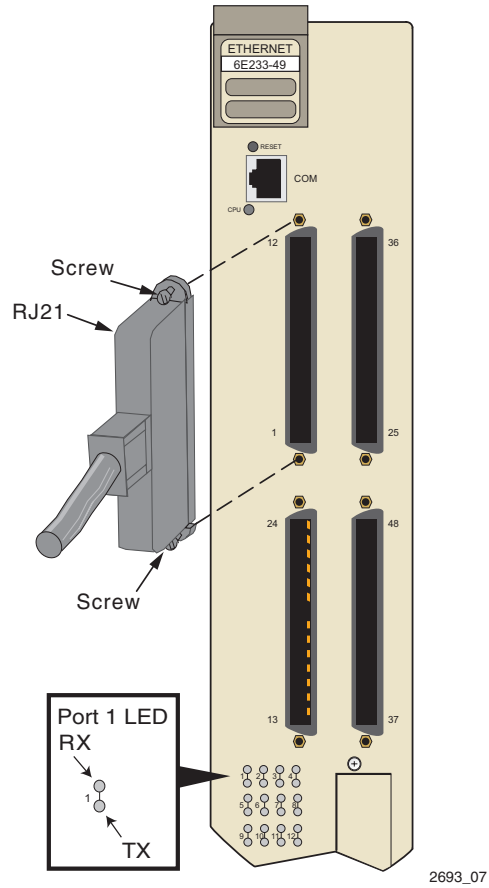

**Figure 3-2 Straight Cable Connection**

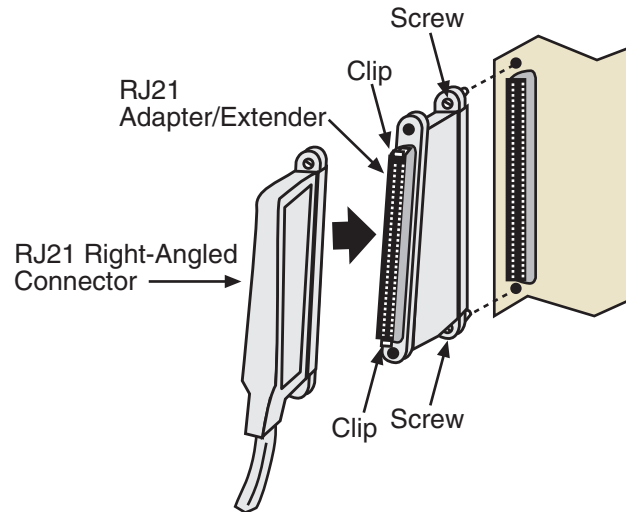

2693\_100

**Figure 3-3 Connection Using the RJ21 Angle Adapter**

3. Tighten the two screws on the RJ21 straight cable connector or RJ21 angle adapter, as applicable, to secure it to the device.



The cable pinouts for a 25-pair cable (RJ21) can be found in the Cabletron Systems *Cabling Guide*. Refer to the [Related Manuals](#) in the [About This Guide](#) preface for details on how to obtain this document.

4. If using the RJ21 angle adapter, plug the RJ21 right-angled connector as shown in [Figure 3-3](#). Depending on the type of RJ21 cable connector, it can be plugged in until the retaining clips on the RJ21 adapter/extender snap into place, or it can be secured with screws.
5. Verify that a link exists on each twisted pair segment of the RJ21 connector by checking that the associated port **RX** LED is on (flashing amber, blinking green, or solid green). [Figure 3-3](#) shows the RX and TX LEDs for port 1. If any of the **RX** LEDs are off, perform the following steps to check the associated twisted pair segment. The problem is resolved when the Link LED comes on.
  - a. Verify that the device at the other end of the twisted pair segment is on and connected to the segment.

- b. Verify that the RJ21 connector associated with the twisted pair segment has the proper pinouts and check the cable for continuity.
- c. Check that the twisted pair connection meets the dB loss and cable specifications outlined in [Chapter 2](#).

If a link is not established, contact Cabletron Systems. Refer to [Section 1.2](#) for details.

- 6. Repeat steps 1 through 5 until all connections are made.

### **3.6 COMPLETING THE INSTALLATION**

After installing the SmartSwitch and any optional HSIM, and making the connections to the network, the SmartSwitch is ready to be configured through Local Management. Refer to *SmartSwitch Series 6H202, 6H203, 6H252, 6H253, 6H258, 6H259, 6H262, 6E233, and 6E253 Local Management User's Guide* for information on how to access and use Local Management. Refer to [Chapter 4](#) for information on LEDs and troubleshooting.

---

## Troubleshooting

This chapter provides information concerning the following:

- Using the LANVIEW diagnostic and status monitoring system ([Section 4.1](#))
- Troubleshooting network and module operational problems ([Section 4.2](#))
- Using the RESET button ([Section 4.3](#))

### 4.1 USING LANVIEW

The 6E233-49 SmartSwitch uses Cabletron Systems' built-in visual diagnostic and status monitoring system called LANVIEW. The LANVIEW LEDs ([Figure 4-1](#)) allow quick observation of the network status to aid in diagnosing network problems. Refer to [Table 4-1](#) for a description of the LEDs.

Refer to the HSIM user's guide for a description of the HSIM LEDs.



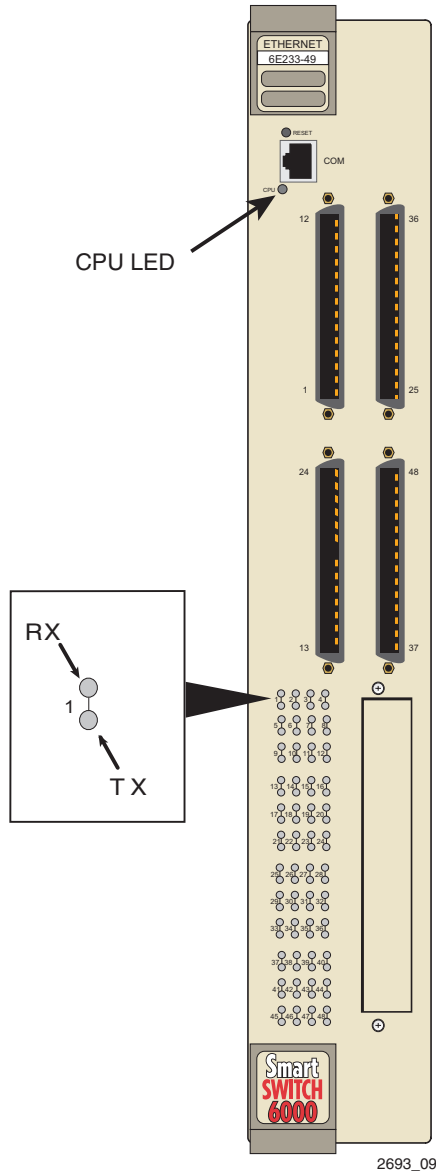

Figure 4-1 LANVIEW LEDs

4-2 Troubleshooting



The terms **flashing**, **blinking**, and **solid** used in the LED definition tables of this chapter indicate the following:

**Flashing** indicates an irregular LED pulse.

**Blinking** indicates a steady LED pulse, (approximately 50% on, 50% off).

**Solid** indicates a steady LED light. No pulsing.

**Table 4-1 LANVIEW LEDs CPU, Receive, and Transmit Status**

LED	Color	State	Recommended Action
CPU	Off	Power off.	Power up chassis.
	Red	<b>Blinking.</b> Hardware failure has occurred.	Contact Cabletron Systems.
		<b>Solid.</b> Resetting, normal power up reset.	If the LED remains red for several minutes, contact Cabletron Systems.
	Amber	<b>Blinking.</b> Crippled.	Contact Cabletron Systems.
		<b>Solid.</b> Testing.	If the LED remains amber for several minutes, contact Cabletron Systems.
	Green	<b>Solid.</b> Functional.	None.
Amber and Green	Booting. Blinks amber and green while booting.	None.	
RX	Off	No link. No activity. Port enabled or disabled.	None.
	Green	<b>Solid.</b> Port enabled, link, no activity.	None.
		<b>Blinking.</b> Port disabled, link.	None.
	Amber	<b>Flashing.</b> Port enabled, link, activity.	None.
	Red	Diagnostic failure.	Contact Cabletron Systems.

**Table 4-1 LANVIEW LEDs CPU, Receive, and Transmit Status (Continued)**

LED	Color	State	Recommended Action
TX	Off	Port enabled, and no activity. Should flash green every two seconds indicating BPDUs being sent if STA is enabled and there is a valid link.	<ol style="list-style-type: none"> <li>1. Ensure that the STA is enabled and that there is valid link. The <i>Local Management User's Guide</i> describes how to enable the STA.</li> <li>2. Contact Cabletron Systems.</li> </ol>
	Green	<b>Flashing.</b> Indicates activity. Rate indicates data rate.	None.
	Amber	<b>Blinking.</b> Port in standby. Port may be disabled due to Spanning Tree.	<ol style="list-style-type: none"> <li>1. Ensure that the port is not disabled. Refer to the <i>Local Management User's Guide</i> for information on enabling/disabling ports.</li> <li>2. Contact Cabletron Systems.</li> </ol>
	Red	<b>Flashing.</b> Indicates collision rate.	None, unless there is a high rate of activity. If so, check for network configuration problems or a defective device.
		<b>Solid.</b> Diagnostic Failure.	Contact Cabletron Systems.

## 4.2 TROUBLESHOOTING CHECKLIST

If the 6E233-49 SmartSwitch is not working properly, refer to [Table 4-2](#) for a checklist of possible problems, causes, and recommended actions to resolve the problem.

**Table 4-2 Fault Identification**

Symptom	Possible Causes
All LEDs are off.	<ol style="list-style-type: none"> <li>1. Installation error - remove 6E233-49 SmartSwitch and perform installation in accordance with installation instructions. Check connectors for dust or dirt and clean as necessary.</li> <li>2. Power system fault - refer to <a href="#">Table 4-3</a>.</li> </ol>
Module stays in BOOT state.	<ol style="list-style-type: none"> <li>1. Device does not have an operable firmware image, and is sending out BootP requests in an effort to locate a BootP server on the network. Press the RESET button on the front panel to attempt to use the firmware image in FLASH memory.</li> <li>2. If the problem continues after pressing the RESET button, refer to <a href="#">Section B.1</a> for instructions on forcing a BootP image download.</li> <li>3. Contact Cabletron Systems if the problem continues.</li> </ol>

**Table 4-3 Power System Troubleshooting**

Possible Causes	Instruction
Loss of power to the 6C105 chassis.	<p>Perform the following steps:</p> <ol style="list-style-type: none"> <li>1. Check ON/OFF switches of 6C105 power supplies. All switches must be in the ON (   ) position.</li> <li>2. Check all power cords and cables for proper connection. Examine power cords for fraying or other damage. Replace if necessary.</li> <li>3. Examine 6C105 chassis power supplies. If power supply LEDs or audible warning tone indicate power supply problems, troubleshoot or replace any faulty power supplies.</li> </ol>
Fault in 6C105 power bus.	<ol style="list-style-type: none"> <li>1. Remove the 6E233-49 SmartSwitch from the current slot and re-install in another free slot in the chassis.</li> <li>2. If the 6E233-49 SmartSwitch functions in the selected slot, the 6E233-49 SmartSwitch onboard power converter is operational. The 6C105 chassis power bus may have a localized fault. Install the 6E233-49 SmartSwitch in the working slot and contact Cabletron Systems.</li> <li>3. If the 6E233-49 SmartSwitch does not function in the selected slot, continue the process with all module slots in the chassis. If the module does not function in any slot, the chassis power bus may have a system-wide fault or the module onboard power converter may be inoperable. Diagnose the module power converter as described below to isolate the fault.</li> </ol>
Fault in 6E233-49 SmartSwitch module power converter.	<ol style="list-style-type: none"> <li>1. Remove a working module from a known good chassis.</li> <li>2. Install the 6E233-49 SmartSwitch in the known good slot.</li> <li>3. If the 6E233-49 SmartSwitch does not function, there may be a fault in the onboard power converter. Contact Cabletron Systems immediately.</li> </ol>

**Table 4-4 Firmware Troubleshooting**

Possible Cause	Instruction
Autobaud enabled.	Press ENTER (RETURN) (may take up to four times).
Terminal setup is not correct.	Refer to the <i>Local Management User's Guide</i> for setup procedures.
Improper console cable pinouts.	Refer to <a href="#">Appendix A</a> for proper console port pinouts.
The COM port of the device has been disabled, or the COM port application has been changed.	<ol style="list-style-type: none"> <li>1. Establish a Telnet connection to the device.</li> <li>2. Refer to the <i>Local Management User's Guide</i> on enabling/disabling the COM port and changing the COM port application.</li> </ol>
Corrupt firmware image, or hardware fault.	<ol style="list-style-type: none"> <li>1. If possible, attempt to download the image to the device again. Refer to <a href="#">Section B.1</a> for instructions on how to force a download of a new firmware image.</li> <li>2. Contact Cabletron Systems if the problem continues.</li> </ol>

**Table 4-5 Management System Troubleshooting**

Possible Causes	Instruction
Cannot access Local Management.	<ol style="list-style-type: none"> <li>1. Firmware image fault - refer to <a href="#">Table 4-4</a>.</li> <li>2. Management system fault - refer to <a href="#">Table 4-5</a>.</li> </ol>
Cannot contact device through in-band management.	<ol style="list-style-type: none"> <li>1. Management System fault - refer to <a href="#">Table 4-5</a>.</li> <li>2. No link to device - verify all network connections between network management station and 6E233-49 SmartSwitch are valid and operating.</li> </ol>
User parameters (IP address, community names, etc.) lost on reset or power-up.	Device setup fault - refer to <a href="#">Table 4-6</a> .
Device is not forwarding traffic from any port.	Device setup fault - refer to <a href="#">Table 4-6</a> .
Improper Community Names Table.	<ol style="list-style-type: none"> <li>1. Refer to the <i>Local Management User's Guide</i> for Community Names Table setup.</li> <li>2. If the Community Names have been forgotten, refer to <a href="#">Section B.1</a> for instructions on clearing NVRAM.</li> </ol>
The 6E233-49 SmartSwitch does not have an IP address.	<ol style="list-style-type: none"> <li>1. Refer to the <i>Local Management User's Guide</i> for IP address assignment procedure.</li> <li>2. If the 6E233-49 SmartSwitch is using the IP address of the 6C105 chassis, ensure that the module is not in STANDALONE management mode. The <i>Local Management User's Guide</i> provides instructions on setting the management mode.</li> </ol>
The applicable front panel port is disabled.	<ol style="list-style-type: none"> <li>1. Enable port. Refer to the <i>Local Management User's Guide</i> for instructions on enabling/disabling ports.</li> <li>2. Port may disabled due to Spanning Tree. Review network design and delete unnecessary loops.</li> </ol>

**Table 4-6 Device Setup Troubleshooting**

Possible Causes	Instruction
The 6E233-49 SmartSwitch detect a looped condition.	<ol style="list-style-type: none"> <li>1. Verify that Spanning Tree is enabled. Refer to the <i>Local Management User's Guide</i> for instructions on setting the type of STA.</li> <li>2. Review network design and delete unnecessary loops.</li> </ol>
Mode switch (7), NVRAM Reset, was changed sometime before either cycling power or pressing the RESET button, causing the user-entered parameters to reset to factory default settings.	<ol style="list-style-type: none"> <li>1. Reenter the lost parameters as necessary. Refer to the <i>Local Management User's Guide</i> for instructions on configuring the device through Local Management.</li> <li>2. Call Cabletron Systems if the problem continues.</li> </ol>
Clear NVRAM was set through Local Management.	<ol style="list-style-type: none"> <li>1. Reenter the lost parameters as necessary. Refer to the <i>Local Management User's Guide</i> for instructions on configuring the device through Local Management.</li> <li>2. Call Cabletron Systems if the problem continues.</li> </ol>



If these troubleshooting tables do not solve any problems that occur with the 6E233-49 SmartSwitch, contact Cabletron Systems. Refer to [Section 1.2](#) for details.



### 4.3 USING THE RESET BUTTON

The RESET button, located near the upper plastic locking tab of the module (refer to [Figure 4-2](#)), resets the 6E233-49 SmartSwitch processor without affecting the NVRAM.



Pressing the RESET button resets the device, and all current switching being performed by the module is halted. A module downtime of up to two minutes results from this action.

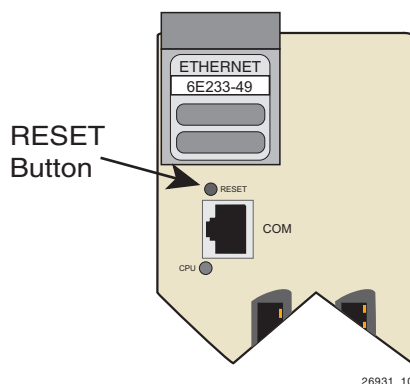

**Figure 4-2** RESET Button

To reset the 6E233-49 SmartSwitch processor, press and release the RESET button. The module processor goes through a reset process of approximately 20 seconds. Additional downtime may be added as the module reenters the network.



It is not recommended to press the RESET button while the module is already in reset mode. The module will enter an extended diagnostic procedure, which is unnecessary for normal operation. This procedure will take much longer than a minute. The ESC key can be used to exit the procedure.

---

## Specifications

This appendix provides operating specifications for the Cabletron Systems 6E233-49 SmartSwitch Interface Module. Cabletron Systems reserves the right to change these specifications at any time without notice.

### A.1 MODULE SPECIFICATIONS

Processor:	Intel i960 RISC processor Power PC
Dynamic Random Access Memory (DRAM):	20 MB expandable to 32 MB
FLASH Memory:	8 MB
Shared Memory:	4 MB

### A.2 PHYSICAL PROPERTIES

Dimensions:	46.43 H x 6.05 W x 29.51 D (cm) 18.28 H x 2.38 W x 11.62 D (in)
Weight (Unit):	Approximately 2.7 kg (6 lb)
MTBF (Predicted):	200,000 hours

### A.3 ENVIRONMENTAL REQUIREMENTS

Operating Temperature:	5°C to 40°C (41°F to 104°F)
Storage Temperature:	-30°C to 73°C (-22°F to 164°F)
Operating Relative Humidity:	5% to 90% (non-condensing)

## A.4 INPUT/OUTPUT PORTS

### 6E233-49 Specifications

Ports 1 through 48:	Ethernet (10BASE-T compliant) through four RJ21 type connectors.
Slot for optional High Speed Interface Module (HSIM):	Slot accepts optional HSIMs that provide a variety of physical cabling types.

## A.5 COM PORT PINOUT ASSIGNMENTS

The COM port is a serial communications port that supports Local Management or connection to a UPS.

Table A-1 shows the COM port pin assignments:

**Table A-1 COM Port Pin Assignments**

Pin	Signal Name	Input/Output
1	Transmit Data (XMT)	Output
2	Data Carrier Detect (DCD)	Output
3	Data Set Ready (DSR)	Input
4	Receive Data (RCV)	Input
5	Signal Ground (GND)	NA
6	Data Terminal Ready (DTR)	Output
7	Request to Send (RTS)	Input
8	Clear to Send (CTS)	NA

## A.6 REGULATORY COMPLIANCE

This equipment meets the following safety and electromagnetic compatibility (EMC) requirements:

Safety:	UL 1950, CSA C22.2 No 950, 73/23/EEC, EN 60950, IEC 950
Electromagnetic Compatibility (EMC):	FCC Part 15, CSA C108.8, 89/336/EEC, EN 55022, EN 61000-3-2, EN 61000-3-3, EN 50082-1, AS/NZS 3548, VCCI V-3

### A-2 Specifications

# B

---

## Optional Installations and Mode Switch Bank Settings

This appendix covers the following items:

- Required tools ([Section B.1](#))
- Locations, functions, and settings for the mode switches ([Section B.2](#))
- Installing the SIMM ([Section B.3](#))
- Installing HSIMs ([Section B.4](#))

### B.1 REQUIRED TOOLS

You need the following tools to perform the procedures provided in this appendix:

- Antistatic wrist strap (provided with 6C105 chassis)

### B.2 SETTING THE MODE SWITCHES

These switches are set at the factory and do not need to be changed unless you intend to perform the following:

- Force download a new image file from a BootP server.
- Clear NVRAM and restore all user-entered parameters such as the IP address and Subnet Masks to the 6E233-49 SmartSwitch “Default” configuration settings.
- Clear user-entered passwords stored in NVRAM and restore the default passwords.

[Figure B-1](#) shows the location of the mode switches and the switch settings for normal operation.

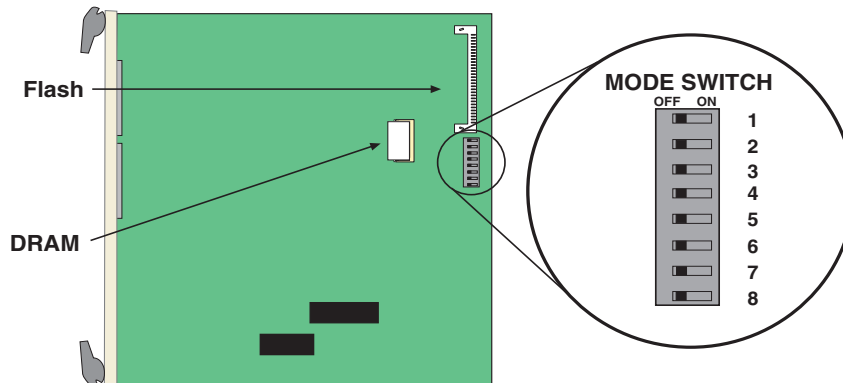

**Figure B-1** Module Mode Switch Location/Component Layout

Switch definitions and positions are as follows:

- Switches 1 through 4 – For Cabletron Systems use only.
- Switch 5 – COM Port Autobaud. The default (OFF) position enables Autobaud sensing on the COM port for Local Management sessions. Changing the switch to the ON position disables Autobaud sensing and sets the COM port to 9600 baud for Local Management sessions.
- Switch 6 – Forced BootP. Changing the position of this switch (i.e., moving the switch from one position to the other) clears download information from NVRAM and forces the SmartSwitch to download a new image file from a BootP server after power to the chassis is restored.



After changing the position of switch 6, DO NOT reapply power to the chassis until there is a station acting as a BootP server, which contains the image file.

- After changing the position of switch 6 and restarting the module, the SmartSwitch requests a new image download until they either receive a new image or the RESET button on the front panel is pressed. When the RESET button is pressed, the SmartSwitch continues trying to contact a BootP server, but will time out in approximately one minute. If the module times out, the image is downloaded from its FLASH memory.
- Switch 7 – Clear NVRAM. Changing the position of this switch resets NVRAM on the next power up. ALL user entered parameters, such as IP addresses, subnet masks, SNMP traps, and switching functions are restored to their factory default settings.

## **B-2** *Optional Installations and Mode Switch Bank Settings*

- Switch 8 – Reset Password/Community Strings. Changing the position of this switch clears only the user-entered passwords stored in NVRAM, and restores the default passwords. Once the SmartSwitch resets, the passwords can either be reentered or the default passwords (Public and ENTER) may be used.

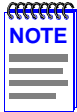

Do not change the position of switch 8 unless it is necessary to reset the module super-user configured passwords to their factory default settings.

### B.3 SIMM UPGRADE

Memory upgrade is available for the 6E233-49 SmartSwitch module to expand the DRAM to 32 MB. This section explains how to locate and add/replace a Single In-line Memory Module (SIMM). For information on the available SIMM upgrades, contact Cabletron Systems. For details on getting help, refer to [Section 1.2](#).

#### B.3.1 Locating SIMMs

[Figure B-2](#) shows the location of the DRAM SIMM connector.

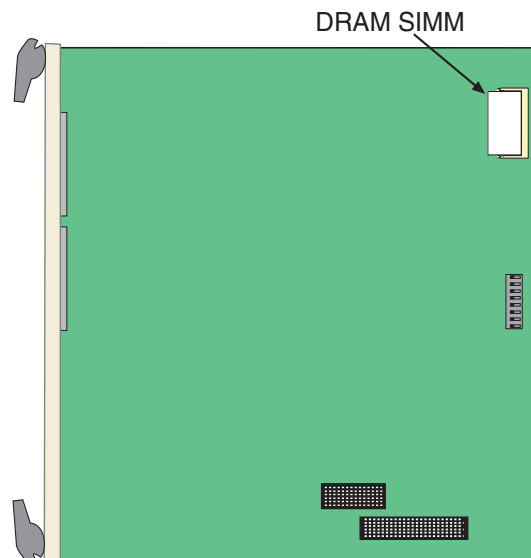

**Figure B-2 SIMM Slot Locations**

### B.3.2 Installing the DRAM SIMM



Observe all antistatic precautions when handling sensitive electronic equipment.

To install a DRAM SIMM, refer to [Figure B-3](#) and proceed as follows:

1. With the SIMM alignment notch oriented as shown in [Figure B-3](#), insert the SIMM down between the connector teeth.
2. Pivot the SIMM downward so the connector clips align with the two side notches of the SIMM and the connector clips lock the SIMM into place.

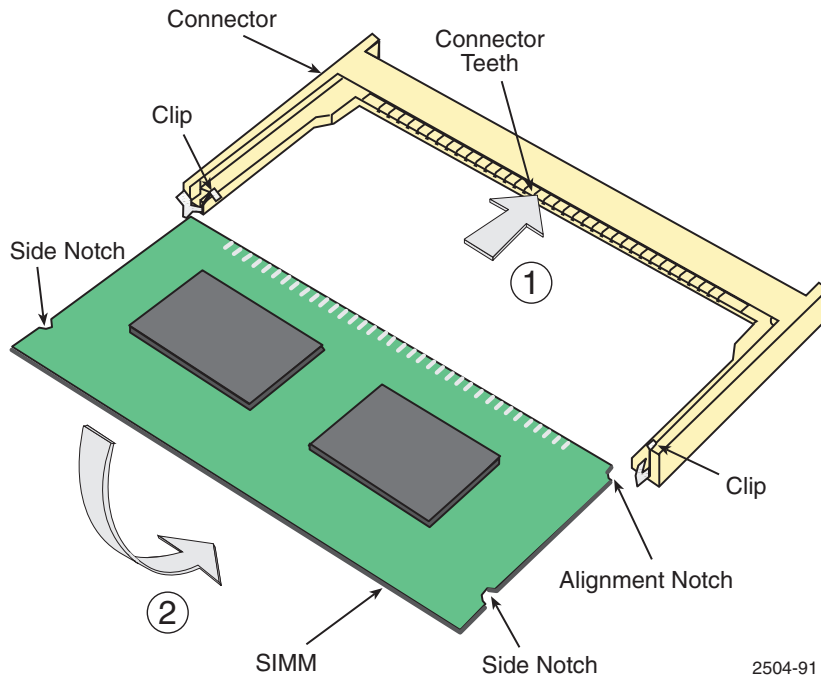
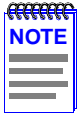

**Figure B-3** Installing the DRAM

### B-4 Optional Installations and Mode Switch Bank Settings

## B.4 INSTALLING OPTIONAL HIGH SPEED INTERFACE MODULES

Figure B-4 shows the location of the connector for an optional High Speed Interface Module (HSIM).



Refer to the installation instructions for the optional HSIM in the associated user's guide.

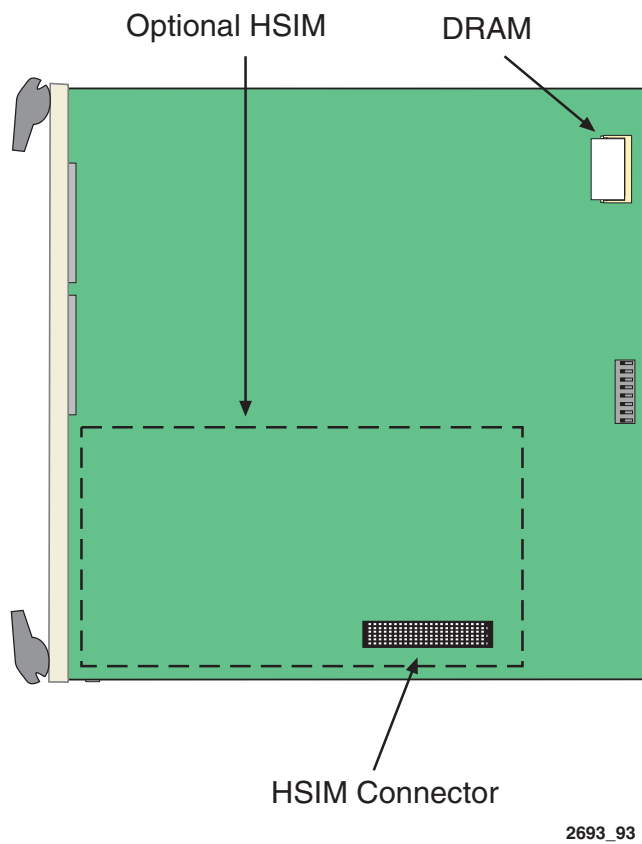

Figure B-4 HSIM Connector Location





---

# Index

## Numerics

---

10BASE-T  
requirements [2-1](#)

## C

---

Cable specifications  
100BASE-T network [2-1](#)  
COM port  
pin assignments [A-2](#)  
Connecting to the network [3-5](#)

## D

---

Documents, related [xvii](#)

## E

---

Environmental requirements [A-1](#)

## I

---

Installation  
Fast Ethernet Interface Module [B-5](#)

## L

---

LANVIEW LEDs [4-1](#)  
LDRAM  
installation [B-4](#)

## M

---

Memory  
upgrading [B-3](#)

## P

---

Physical properties [A-1](#)  
Port Redirect Function, introduction to [1-5](#)

## R

---

Redirect functions  
port and VLAN, introduction to [1-5](#)  
Related documents [xvii](#)  
RESET button [4-10](#)

## S

---

Safety [A-2](#)  
Safety information  
laser [ix](#)  
SDRAM  
installation [B-4](#)  
SIMMs  
installing  
LDRAM [B-4](#)  
location [B-3](#)  
SmartTrunk, introduction to [1-4](#)  
Specifications [A-1](#)  
Standards compatibility [1-7](#)

---

## T

---

Troubleshooting 4-1  
checklist 4-5

## U

---

Unpacking 3-1

## V

---

VLAN Redirect Function, introduction to 1-5



## Artisan Technology Group is your source for quality new and certified-used/pre-owned equipment

- FAST SHIPPING AND DELIVERY
- TENS OF THOUSANDS OF IN-STOCK ITEMS
- EQUIPMENT DEMOS
- HUNDREDS OF MANUFACTURERS SUPPORTED
- LEASING/MONTHLY RENTALS
- ITAR CERTIFIED SECURE ASSET SOLUTIONS

### SERVICE CENTER REPAIRS

Experienced engineers and technicians on staff at our full-service, in-house repair center

### *InstraView*<sup>SM</sup> REMOTE INSPECTION

Remotely inspect equipment before purchasing with our interactive website at [www.instraview.com](http://www.instraview.com) ↗

### WE BUY USED EQUIPMENT

Sell your excess, underutilized, and idle used equipment. We also offer credit for buy-backs and trade-ins. [www.artisanng.com/WeBuyEquipment](http://www.artisanng.com/WeBuyEquipment) ↗

### LOOKING FOR MORE INFORMATION?

Visit us on the web at [www.artisanng.com](http://www.artisanng.com) ↗ for more information on price quotations, drivers, technical specifications, manuals, and documentation

**Contact us:** (888) 88-SOURCE | [sales@artisanng.com](mailto:sales@artisanng.com) | [www.artisanng.com](http://www.artisanng.com)